

# A LABORATORY HISTORY OF CHEMICAL WARFARE AGENTS

Second Edition

A book by Jared Ledgard



## **A Laboratory History of chemical Warfare Agents®**

Copyright © 2006 by Jared B. Ledgard. All rights reserved.

Printed in the United States of America. No part of this manual can be reproduced or distributed in any form or by any means without the prior written permission of the author. Furthermore, no part of this manual can be reproduced in any form or by any means, and stored in a database or other computer related storage system, public or private. **Furthermore, no part of this book, including text, images, references, ect., ect., can be copied or duplicated in anyway and placed upon a web page of any kind without prior permission of the author, or publisher.**

The author, writer, and publisher take no responsibility for the actions of anyone as a result of this manual. People who use this manual to make or prepare warfare agents, explosives, explosive compositions, or explosive munitions take full responsibility for their actions. Any injuries, deaths, or property damage caused or produced by the actions of person or persons using this manual are not the result or responsibility of the author, writer, or publisher. Any attempt to sue or bring about any form of legal action against the author, writer, or publisher as a result of injury, death, or property damage caused by the negative intentions of a person or persons who used information in this manual is a direct violation of freedom of speech laws, and information right-to-know laws.

Information contained in this manual was taken from public sources, and is therefore bound to freedom of speech and information protection laws as discussed in the US constitution. The information contained in this manual was edited, and rewritten to fit a form readable by the common man as well as scientist. The information is not the sole responsibility of the author, writer, or publisher. Any injuries, deaths, or property damage associated with any of the procedures detailed in this manual are not the result, nor responsibility of the author, writer, or publisher. Every procedure discussed in this manual has been successfully carried out with safe, reliable, and effective results. Any attempt to sue or bring about any form of legal action against the author, writer, or publisher as a result of a person or persons negligence, stupidity, or gross incompetence is a direct violation of freedom of speech laws, and information right-to-know laws.

This manual is intended for educational purposes only, and the author, writer, and publisher are not aware of any danger this manual may or may not pose to people or property if used by person or persons with negative intentions. The author, writer, and publisher have no intent, nor desire to aid or provide potentially dangerous information to persons with desires to injure, kill, or cause property damage. The information contained in this manual is for reference purposes only, and the author, writer, and publisher made this manual possible to inform, enlighten, and educate persons interested or curious in the art of chemical warfare. This manual was created by the author, writer, and publisher to deliver knowledge and truth. Any attempts to sue or bring about law suits against the author, writer, or publisher for any reason associated with this manual is a direct violation of knowledge and truth, and is therefore, a violation of the US constitution.

A Laboratory History of chemical Warfare Agents  
ISBN 978-0-6151-3645-5



# CONTENTS

<b>Section I: Laboratory Tutorial and reference guide</b> .....	Page 001
<b>Chapter 1: Laboratory tutorial on techniques and procedures</b> .....	Page 001
Introduction.....	Page 001
Lab safety.....	Page 001
Laboratory equipment.....	Page 003
Methods of heating.....	Page 004
Methods of cooling.....	Page 006
Extraction.....	Page 008
Salting out.....	Page 010
Recrystallization, product recovery, and filtration.....	Page 010
Filtration.....	Page 011
Washing liquids and solids.....	Page 013
Drying agents and drying liquids.....	Page 014
Distillation.....	Page 015
<b>Chapter 2: Reference guide</b> .....	Page 019
<b>Section II: Lachrymatory, disabling, and irritant agents</b> .....	Page 047
<b>Chapter 3: Physical Nature of Lachrymator, disabling, and irritant substances..</b>	Page 047
Introduction.....	Page 047
Physical properties of riot control, disabling, and irritant agents.....	Page 047
Protection.....	Page 047
Decontamination.....	Page 047
Mechanism of body action.....	Page 048
Signs and symptoms.....	Page 048
Treatment.....	Page 048
<b>Chapter 4: Preparation of Lachrymator, disabling, and irritant substances</b> .....	Page 049
01-001. Chloropicrin.....	Page 049
Procedure 1-001A: Preparation of Chloropicrin.....	Page 049
Procedure 1-001B: Preparation of Chloropicrin.....	Page 050
01-002. Bromopicrin.....	Page 051
Procedure 1-002A: Preparation of Bromopicrin.....	Page 052
01-003. DA. Diphenylchloroarsine.....	Page 054
Procedure 1-003A: Preparation of Diphenylchloroarsine.....	Page 055
01-004. DM. Adamsite.....	Page 056
Procedure 1-004A: Preparation of Adamsite.....	Page 056
01-005. CA. Chloroacetone.....	Page 058
Procedure 1-005A: Preparation of Chloroacetone.....	Page 058
01-006. DCA. Dichloroacetone.....	Page 059
Procedure 1-006A: Preparation of Dichloroacetone.....	Page 060
01-007. BC. Bromoacetone.....	Page 061
Procedure 1-007A: Preparation of Bromoacetone.....	Page 062
01-008. DIIMINE.....	Page 063
Procedure 1-008A: Preparation of DIIMINE.....	Page 064
01-009. CS.....	Page 065
Procedure 1-009A: Preparation of CS.....	Page 065
01-010. CN. Chloroacetophenone.....	Page 067
Procedure 1-010A: Preparation of CN.....	Page 067
01-011. BBC.....	Page 068
Procedure 1-011A: Preparation of BBC.....	Page 069
<b>Section III: Blood agents</b> .....	Page 072
<b>Chapter 5: Physical Nature of Blood Agents</b> .....	Page 072
<b>I. Cyanides</b> .....	Page 072
Introduction.....	Page 072
Physical properties (hydrogen cyanide).....	Page 072
Detection.....	Page 072
Protection.....	Page 072
Decontamination.....	Page 072
Mechanism of action within the body.....	Page 073
Signs and symptom of exposure.....	Page 073
Treatment.....	Page 073
Administration of cyanide antidotes.....	Page 073
<b>II. Cyanogens</b> .....	Page 074
Treatment.....	Page 074

Physical properties.....	Page 074
Detection.....	Page 074
Decontamination.....	Page 074
Mechanism of action within the body.....	Page 074
Signs and symptoms of exposure.....	Page 075
Treatment.....	Page 075
<b>III. Arsines.....</b>	<b>Page 075</b>
Introduction.....	Page 075
Physical properties.....	Page 075
Mechanism of action within the body.....	Page 076
Signs and symptoms of exposure.....	Page 076
Treatment.....	Page 076
<b>IV. Phosgene.....</b>	<b>Page 076</b>
Introduction.....	Page 076
Physical properties of phosgene.....	Page 076
Detection.....	Page 076
Protection.....	Page 077
Decontamination.....	Page 077
Mechanism of action within the body.....	Page 077
Signs and symptoms.....	Page 077
Treatment.....	Page 077
<b>Chapter 6: The Preparation of blood agents.....</b>	<b>Page 079</b>
02-001. AC. Hydrogen cyanide.....	Page 079
Procedure 2-001A: Preparation of Hydrogen cyanide (cyanide process).....	Page 079
Procedure 2-001B: Preparation of Hydrogen cyanide (ferrocyanide process)...	Page 081
02-002. CA. Cyanogen.....	Page 082
Procedure 2-002A: Preparation of Cyanogen (hydrogen cyanide process).....	Page 083
02-003. CK. Cyanogen chloride.....	Page 084
Procedure 2-003A: Preparation of Cyanogen Chloride (chlorine process).....	Page 085
Procedure 2-003B: Preparation of Cyanogen Chloride (chlorine process).....	Page 086
02-004. BC. Cyanogen bromide.....	Page 088
Procedure 2-004A: Preparation of Cyanogen Bromide.....	Page 088
Procedure 2-004B: Preparation of Cyanogen Bromide.....	Page 089
02-005. Arsine.....	Page 090
Procedure 2-005A: Preparation of Arsine.....	Page 091
02-006. VS. Vinylarsine.....	Page 093
Procedure 2-006A: Preparation of Vinylarsine.....	Page 094
02-007. Phosgene. Carbonyl chloride.....	Page 095
Procedure 2-007A: Preparation of Phosgene (liquid chlorine process).....	Page 096
Procedure 2-007B: Preparation of Phosgene (carbon process).....	Page 098
<b>Section IV: Blister agents (potent vesicants; tissue damaging agents).....</b>	<b>Page 101</b>
<b>Chapter 7: Physical Nature of Blister agents.....</b>	<b>Page 101</b>
Introduction.....	Page 101
<b>I. Mustard agents.....</b>	<b>Page 101</b>
Physical and Chemical properties.....	Page 102
Detection.....	Page 102
Protection.....	Page 102
Decontamination.....	Page 103
Mechanism of action.....	Page 103
Toxicity of the mustards.....	Page 103
Treatment of mustard lesions.....	Page 105
Secondary infections as a result of mustard agent exposure.....	Page 105
Long term effects of mustard exposure.....	Page 105
<b>II. Arsenicals.....</b>	<b>Page 106</b>
Introduction.....	Page 106
Physical and chemical characteristics.....	Page 106
Detection.....	Page 106
Protection.....	Page 107
Decontamination.....	Page 107
Mechanism of action in the body.....	Page 107
Body effects.....	Page 107
General treatment.....	Page 108
<b>III. Phosgene oxime.....</b>	<b>Page 108</b>
Introduction.....	Page 108
Physical properties of phosgene oxime.....	Page 108
Detection.....	Page 108
Protection and decontamination.....	Page 108

Mechanism of action.....	Page 108
Physical effects.....	Page 109
Treatment.....	Page 109
<b>Chapter 8: Preparation of Blister Agents.....</b>	<b>Page 110</b>
03-001. Sulfur Mustard. Mustard gas. Kampfstoff.....	Page 110
Procedure 3-001A: Preparation of Mustard gas (levinsein process).....	Page 110
Procedure 3-001B: Preparation of Mustard gas (levinsein process).....	Page 112
Procedure 3-001C: Preparation of Mustard gas (sodium sulfide process).....	Page 113
03-002. Sulfur Mustard-II. Mustard gas II.....	Page 115
Procedure 3-002A: Preparation of Mustard gas II (sodium sulfide process).....	Page 116
03-003. MD. Methylchloroarsine.....	Page 117
Procedure 3-003A: Preparation of Methylchloroarsine.....	Page 118
03-004. ED. Ethylchloroarsine.....	Page 119
Procedure 3-004A: Preparation of Ethylchloroarsine.....	Page 120
Procedure 3-004B: Preparation of Ethylchloroarsine.....	Page 122
03-005. Lewisite. 2-Chlorovinylchloroarsine.....	Page 123
Procedure 3-005A: Preparation of Lewisite.....	Page 124
Procedure 3-005B: Preparation of Lewisite (modified process).....	Page 125
03-006. PD. Phenylchloroarsine.....	Page 126
Procedure 3-006A: Preparation of Phenylchloroarsine.....	Page 127
03-007. AS-20. Distilled Arsenic mixture.....	Page 128
Procedure 3-007A: Preparation of AS-20.....	Page 129
03-008. HN1. N-ethyl-2,2'di(chloroethyl) amine.....	Page 131
Procedure 3-008A: Preparation of HN1.....	Page 132
Procedure 3-008B: Preparation of HN1 (sulfur/chlorine process).....	Page 133
03-009. HN2. N-methyl-2,2'di(chloroethyl) amine.....	Page 135
Procedure 3-009A: Preparation of HN2.....	Page 136
Procedure 3-009B: Preparation of HN2 (sulfur/chlorine process).....	Page 138
03-10. HN3. tris(beta-chloroethyl)amine.....	Page 139
Procedure 3-010A: Preparation of HN3.....	Page 141
Procedure 3-010B: Preparation of HN3 (sulfur/chlorine process).....	Page 142
03-011. HN4. tris(beta-chlorobutyl)amine.....	Page 144
Procedure 3-011A: Preparation of HN4.....	Page 145
Procedure 3-011B: Preparation of HN4 (sulfur/chlorine process).....	Page 147
03-012. CX. Phosgene oxime.....	Page 149
Procedure 3-012A: Preparation of Phosgene oxime.....	Page 150
<b>Section V: Nerve agents (Potent acetylcholinesterase inhibitors).....</b>	<b>Page 153</b>
<b>Chapter 9: Physical Nature of Nerve agents.....</b>	<b>Page 153</b>
Introduction.....	Page 153
History.....	Page 153
Military use.....	Page 154
Chemical nature.....	Page 154
Environmental persistence.....	Page 155
Toxicity: Mechanisms of action.....	Page 156
Symptoms from exposure.....	Page 156
Treatment.....	Page 156
Methods of body entry and potential fates of exposure thereto.....	Page 157
Metabolism.....	Page 157
Behavioral effects of nerve agent exposure.....	Page 157
Combined effects of nerve agents with other warfare agents.....	Page 158
Potential pretreatment of personnel.....	Page 158
Chronic exposure.....	Page 158
Delayed effects.....	Page 158
Acute effects.....	Page 159
Exposure to high concentrations of nerve agent.....	Page 159
Long term effects after recovery.....	Page 159
Short term exposure with unknown concentrations (through inhalation).....	Page 160
Short-term exposure to unknown concentrations (through eye and skin contact)...	Page 160
Intermediate syndromes.....	Page 160
Recovery.....	Page 161
Summary and conclusion.....	Page 161
<b>Chapter 10: Preparation of Nerve Agents.....</b>	<b>Page 163</b>
04-001. Sarin. GB; Trilon 46.....	Page 163
Procedure 04-001A: Preparation of Sarin (sodium fluoride process).....	Page 163
Procedure 04-001B: Preparation of Sarin (preferred procedure).....	Page 166
Procedure 04-001C: Preparation of Sarin (modified sodium fluoride process)..	Page 169
04-002. Thiosarin. GS. Sulfur sarin.....	Page 171

Procedure 04-002A: Preparation of Thiosarin.....	Page 172
04-003. ChloroSarin. ClGB.....	Page 174
Procedure 04-003A: Preparation of Chlorosarin.....	Page 174
04-004. Sarin-Ethyl. GBE. Sarin-II.....	Page 176
Procedure 04-004A: Preparation of Sarin-ethyl.....	Page 177
Procedure 04-004B: Preparation of Sarin-ethyl (sodium fluoride process).....	Page 179
04-005. FluoroTabun Hydrochloride. FTH.....	Page 182
Procedure 04-005A: Preparation of FluoroTabun Hydrochloride.....	Page 182
04-006. Tabun. GA.....	Page 184
Procedure 04-006A: Preparation of Tabun (preferred process).....	Page 185
Procedure 04-006B: Preparation of Tabun.....	Page 187
04-007. NPF. Neopentylene phosphoryl fluoridate.....	Page 189
Procedure 04-007A: Preparation of NPF.....	Page 190
04-008. Sarin-isopropyl. GBI. Sarin-III.....	Page 191
Procedure 04-008A: Preparation of Sarin-isopropyl.....	Page 192
Procedure 04-008B: Preparation of Sarin-isopropyl (sodium fluoride process).....	Page 195
04-009. Cyclosarin. GF.....	Page 197
Procedure 04-009A: Preparation of Cyclosarin (sodium fluoride process).....	Page 198
Procedure 04-009B: Preparation of Cyclosarin (preferred procedure).....	Page 200
04-010. ThioTabun. GAA.....	Page 202
Procedure 04-010A: Preparation of Thiotabun.....	Page 203
04-011. Soman. GD. Trilon.....	Page 205
Procedure 04-011A: Preparation of Soman (sodium fluoride process).....	Page 206
Procedure 04-011B: Preparation of Soman (preferred process).....	Page 208
Procedure 04-011C: Preparation of Soman (sodium fluoride process).....	Page 210
04-012. NPSF. Neopentylene thiophosphorus fluoridate.....	Page 213
Procedure 04-012A: Preparation of NPSF.....	Page 213
04-013. Tabun-II. GAA.....	Page 215
Procedure 04-013A: Preparation of Tabun-II.....	Page 216
04-014. ThioSoman. GDS. ThioTrilon.....	Page 217
Procedure 04-014A: Preparation of Thiosoman.....	Page 218
04-015. ChloroSoman. GDCl. ChloroTrilon.....	Page 220
Procedure 04-015A: Preparation of Chlorosoman.....	Page 221
04-016. VX. TX-60.....	Page 222
Procedure 04-016A: Preparation of VX.....	Page 223
04-017. IIVX. Sub-VX.....	Page 227
Procedure 04-017A: Preparation of IIVX.....	Page 228
04-018. V-sub x.....	Page 230
Procedure 04-018A: Preparation of V-sub x.....	Page 231
<b>Section VI: Experimental chemical warfare.....</b>	Page 234
<b>Chapter 11: The preparation of experimental chemical warfare agents.....</b>	Page 234
Overview.....	Page 234
11-001. Chemical agent 4-692-530-01.....	Page 235
Procedure 11-001A: Preparation of Chemical agent 4-692-530-01.....	Page 236
11-002. Chemical agent 4-692-530-02.....	Page 238
Procedure 11-002A: Preparation of Chemical agent 4-692-530-02.....	Page 238
11-003. Chemical agent 4-686-293-01.....	Page 240
Procedure 11-003A: Preparation of Chemical agent 4-686-293-01.....	Page 240
11-004. Chemical agent 4-686-293-02.....	Page 242
Procedure 11-004A: Preparation of Chemical agent 4-686-293-02.....	Page 243
<b>Section VII: Methods of dissemination and use.....</b>	Page 246
<b>Chapter 12: Dissemination techniques and munitions.....</b>	Page 246
<b>I. Aerosol Techniques (pressure release systems).....</b>	Page 246
<b>II. Smoke generating techniques (pyrotechnic devices).....</b>	Page 248
<b>III. Explosive techniques (explosives munitions).....</b>	Page 250
<b>IV. Special techniques (atomizers, humidifiers, and foggers).....</b>	Page 252
<b>References.....</b>	Page 256

# Section I

## LABORATORY TUTORIAL AND REFERENCE GUIDE

### Chapter 1: Laboratory tutorial on techniques and procedures

#### Introduction

Before reading the procedures in this book, you should take a quick lesson in laboratory techniques to better help you understand the procedures discussed in this book. Many of the procedures in this book include vacuum distillation, which will be discussed in detail later on in the chapter. Unlike the Preparatory Manual of Explosives, this book has much less extractions and recrystallization to deal with; nonetheless, these two subjects will be discussed in the same manner as in The Preparatory Manual of Explosives.

First of all, laboratory safety is crucial, especially when carrying out procedures on chemical warfare. It should be noted that the procedures discussed in this book are very dangerous, and should only be carried out by qualified and trained personnel only. The riot control, disabling, and irritating substance can be prepared without too much safety precaution, but in no way should the blood agents, blister agents, or nerve agents be prepared unless the proper safety precautions are used. Furthermore, let it be understood that the preparation of chemical warfare agents (other than the riot control, disabling, and irritant agents) is illegal, and possession by unlicensed persons is a federal offense; nerve agents are controlled substances.

This book is intended to educate people about the chemistry and laboratory techniques involved in the preparation of chemical warfare agents. It should be understood that this book represents over 100 years of chemical warfare development, and is intended for educational purposes only. Police officers, other civil authorities, and military personnel can use this book for training purposes. Inventors and researchers may find this book an invaluable tool for their own research and development programs. **Note: Do not attempt to prepare the compounds detailed in this book if you are not of the scientific community.**

#### Lab safety

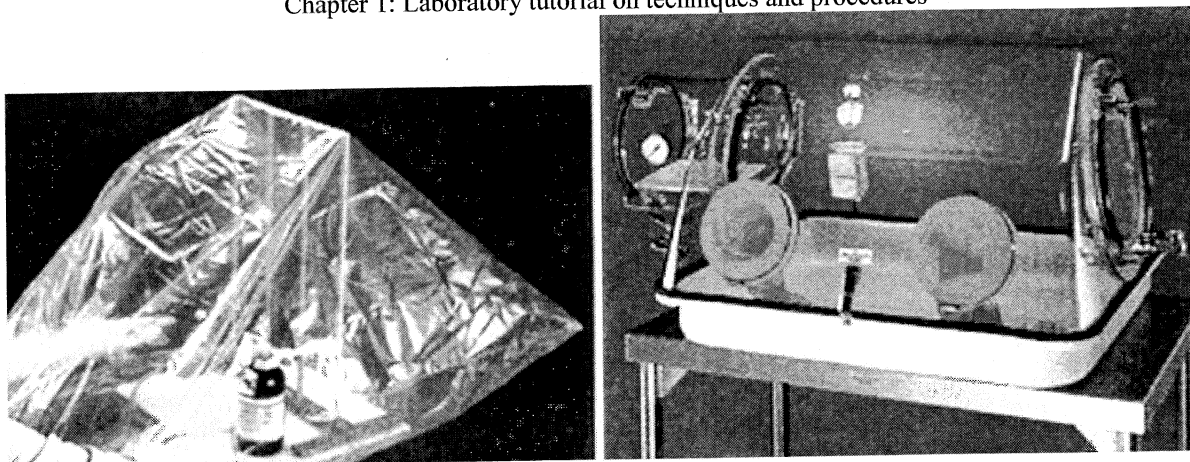
Lab safety is the first step in proper laboratory techniques. For each chemical procedure, read directions carefully, and know precisely what you need to do, before you actually do it. After reading the procedure think about the procedure, and know the hazards associated with it. Know the chemicals used in the procedure and how to properly handle them. Do not attempt to alter the procedure or change chemicals. The best safety is to prevent accidents before they happen.

Carry out all procedures involving riot control agents, disabling agents, and irritant agents using proper ventilation. Fume hoods work in most cases, but not all. Even in well-ventilated fume hoods, irritant agents can expand outward contaminating the entire lab. Vapors can travel long distances and cover large areas despite well ventilation.

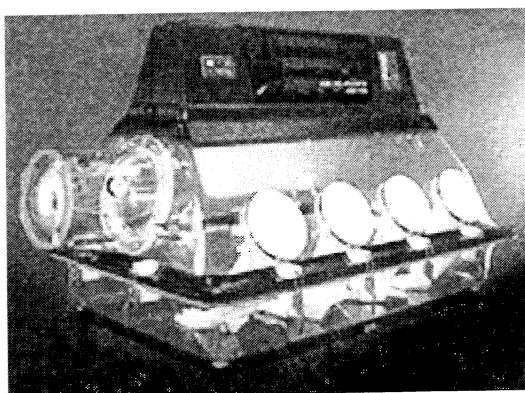
Under any circumstance, eye protection should be used at all times. Eye protection should include eye goggles that completely seal the eyes; glasses are not proper eye protection.

Blister agents should be prepared in properly ventilated areas, and the preparer should wear a certified full-face gas mask. Nitrile gloves, and proper chemical suit should also be worn. The fume hood used should have maximum flow ventilation, with suction venting coming from multiple areas of the hood. In any case, it is better to use clean boxes, containing a positive nitrogen atmosphere.

Blood agents and nerve agents should definitely be prepared in clean boxes under all circumstances. Nerve agents and blood agents can spread over wide areas, even under high ventilation conditions. Preparers should have full body chemical suits and full-face gas masks within reach. With any preparation, electronic monitoring systems should be used to immediately alert personnel to the slightest presence of blood agent or nerve agent.



**Figure 001. Left: A common laboratory “two-handed” atmosphere bag. Right: A classic laboratory clean box (other wise known as a “nitrogen dry box”.**



**Figure 002. Another common clean box with electronic monitoring systems.**

For general handling of chemicals (not involving any warfare agent) including common solvents, reagents, and intermediates, the following checkpoints should be observed:

- 1) Always remember to wear safety goggles at all times. Clothing and equipment can be replaced, but your eyes can't. Contact lenses or glasses are not a substitute for safety goggles. If you get chemicals in your eyes (liquid, gas, or vapor) immediately flush with large amounts of water.
- 2) Immediately wash off any chemical you happen to spill on yourself. Most chemicals are dangerous only if they linger, so take action at once. Concentrated sulfuric acid is not very harmful if washed off immediately, and most acids do little or no skin damage if they are immediately washed off with water.
- 3) In case of an accident such as a fire, save yourself first. Keep fire extinguishers in arms reach, and have an adequate water source within reach. For acid spills, simple baking soda can be used to neutralize it.
- 4) Avoid open flames in a laboratory setting, and do not smoke in the lab. In the event of a fire, calmly but quickly move away from the burning area. Fight the fire only if you are confident the fire can be extinguished.
- 5) Do not eat or drink food products while in the lab. Food and drink can become contaminated by accident, and never use laboratory glassware for eating or drinking.
- 6) Never taste chemicals, and never smell chemicals by sticking your nose right up to the container. Smell chemicals by wafting the vapors with your hand to your nose. Many accidents have occurred when fingers were contaminated in the laboratory and then later used to rub eyes or for eating snacks. Remember to wear gloves at all times. Latex gloves work for most cases, but in some cases nitrile gloves are recommended. Especially when handling strong acids, or chlorinated solvents. If bare handed, wash hands after touching chemicals and/or their storage bottles.
- 7) Breathing or handling small amounts of noxious substances does not pose immediate danger, but you should avoid contact with any potentially noxious chemical under all circumstances. Toxic chemicals should be handled with great care, and proper ventilation (fume hoods with maximum settings) should be used. If fume hoods are not available, the toxic chemicals should be handled in well-ventilated rooms with open windows to allow good airflow. Most organic solvents are very volatile and flammable, so proper ventilation should be exercised as well. Always remember, if you can smell a substance, you are breathing it into your lungs.
- 8) Wear inexpensive clothing when working in a lab. Since there is a possibility of clothing being destroyed in a laboratory accident, a lab coat or an apron should be worn at all times. Do not wear sandals or thong shoes when in the laboratory. Confine long hair and/or



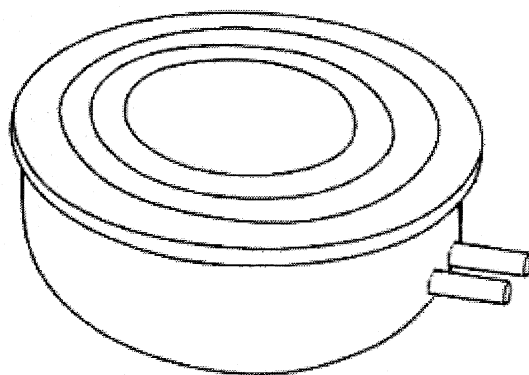




Bunsen burners refer to the term free flame. The Bunsen burner is a commonly used heating device in general chemistry labs, but its use in modern labs is limited. It is very inexpensive to purchase and operate, and permits mixtures to be heated rapidly. Bunsen burners are also commonly used to heat solids. Their use in heating liquids is limited due to potential hazards. Heating liquids with Bunsen burners can lead to violent bumping and foaming. This bumping and foaming can lead to flashovers. In general, never heat flammable liquids with Bunsen burners. When using Bunsen burners, be certain there are no flammable solids, liquids, or vapors in the vicinity.

## 2) Steam bath

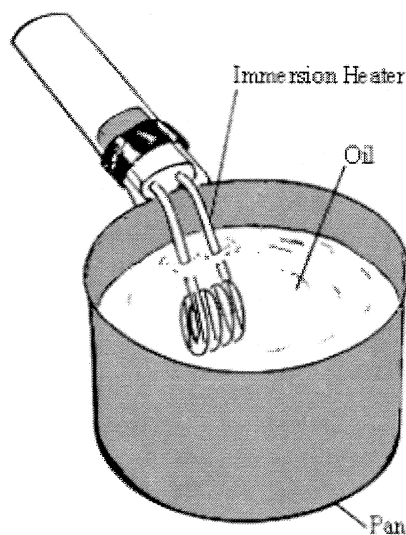
Steam baths are an inexpensive and useful way for heating mixtures up to 100 Celsius. Steam baths can also be used to heat mixtures from 50 to 90 Celsius. Steam baths are very easy to use and operate, and they heat mixtures without blind spots. Blind spots occur when heating is not even. A steam bath is much more useful for heating low-boiling liquids than a free flame, and any vapors which may escape from the distillation apparatus simply dissipate with the steam.



**Figure 006. A common steam bath. To use a steam bath, remove enough rings so that a round-bottom flask will rest on a ring enough so to expose it to the steam without falling through.**

## 3) Oil bath

Oil baths are useful for heating mixtures. The contact of the flask with the hot oil heats the flask perfectly because the hot oil completely surrounds the sides of the flask. This results in even heating and effective temperature control. Oil baths are relatively inexpensive and are safe to operate because they lack an open flame. Oil baths are slow to heat, and they cool slowly after use. These are some of the drawbacks associated with oil baths. In addition, the flask retains an oily residue, which is slippery and must be cleaned off.



**Figure 007. A typical immersion heater used with an oil bath. The flask is immersed about half way into the oil.**

#### 4) Electric Heating Mantles

Heating mantles are the most common method of heating round bottom glassware, and they come in a wide variety of shapes and sizes. Sizes ranging from 10 milliliters to a whopping 12 liters are available. The most common sizes are the 250 milliliter, 500 milliliter, and 1000 milliliter models. These models range in price from 80 to 200 dollars. A voltage regulator is usually used to control the heating, and is sold separately. Exercise care in setting the voltage of a heating mantle because too much voltage can lead to undesired temperature. Test the voltage regulator on an empty flask equipped with a thermometer to familiarize you with the temperature settings. Some voltage regulators will clearly indicate the temperature. A label is usually attached to the heating mantle, which indicates the maximum safe voltage. Note: A heating mantle designed to tolerate a maximum of 20 volts quickly burns out if 120 volts is applied. Read the maximum tolerances aloud for your heating mantle before using it. Most 100 to 500 milliliter heating mantles tolerate a full 120-volt input, and some large mantles even require two voltage regulators. On a final note, be certain the heating mantles size is appropriate for the flask being used.

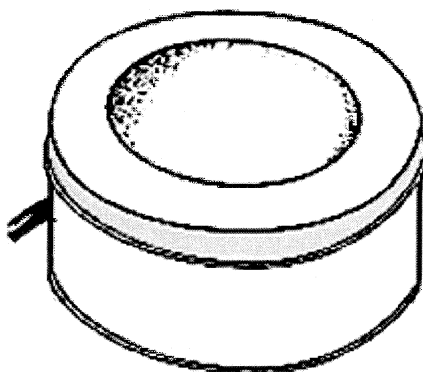


Figure 008. A classic heating mantle.

#### 5) Hot Plates

Hot plates are by far the most common method of heating flat bottom laboratory glassware. Hotplates are exclusively used in heating Erlenmeyer flasks and beakers. Many hot plates come doubled with a magnetic stirrer and are usually called hot plate/stirrers. These hot plate/stirrers are very useful in the heating and the simultaneous mixing of liquids. Some hot plates come without magnetic stirrers. Laboratory hotplates heat relatively slow and they cool slowly, but their energy efficient and they maintain the desired temperatures for indefinite time.

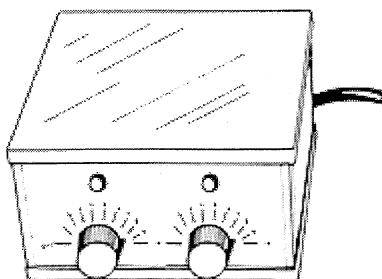


Figure 009. A common hot plate with a magnetic stirrer. Most hot plates double as magnetic stirrers.

### Methods of Cooling

Cooling is often required during a chemical reaction in order to maintain proper reaction temperatures. Not properly cooling reaction mixtures can lead to conditions including evolution of poisonous gases, decomposition of products, and unwanted side reactions. Cooling baths are cheap and readily available. Dry ice is readily available and is used to make excellent cooling baths. Cooling is not as easy as it may appear. In some ice baths the ice will melt rapidly during the chemical reaction. Ice that rapidly melts must be continuously refilled in order to maintain proper reaction temperature.

## Chapter 1: Laboratory tutorial on techniques and procedures

Cooling baths should be at least three times the volume of the reaction flask. For example, if using a 1-liter flask to contain the reaction mixture, a 3-liter container should be used to house the 1-liter flask. Before adding the cooling agent (ice water, ice, or dry ice) to the bath, make sure the 1-liter flask is seated in the bath container. Then fill the container with the cooling agent. The 1-liter flask should be submerged as far as possible into the ice bath. In other words, 80% of the total height of the 1-liter flask should be submerged in the cooling bath. In some cases the flask being cooled will displace the cooling agent (cold water, or ice water) causing it to float and possibly tip over. Lead rings, which are cheap and commercially available, make useful weights to keep the reaction flask seated in the cooling bath.

### 1) Cold water bath

Simple cooling utilizes a cold-water bath. Cold-water baths are used to keep the reaction temperature from 15 to 50 Celsius. In some cases the water bath will have to be quickly drained, and then refilled with cold water in order to maintain the desired reaction temperature. In most cases cold-water baths are used for general long-term temperature control.

### 2) Ice water bath

Ice water baths are commonly used to keep reaction temperatures around 5 to 30 Celsius. Ice water baths are used in place of cold-water baths where long term cooling, but a slight colder temperature is needed.

### 3) Standard ice bath

The standard ice bath is the most common method of cooling reaction mixtures. This method of cooling can produce temperatures of 0 to 20 Celsius. Ice baths are composed of chopped up pieces of ice, and the ice should be finely crushed so that it adheres to the wall of the reaction flask as much as possible. Remember to place the reaction flask into the empty bath container before adding the ice. As the cooling proceeds the ice may melt rapidly, moderately, or slow. If the ice is melted, drain off the water and then add more finely crushed ice. Continue the process as many times as needed. Depending on the time and conditions, the ice may not have to be replaced.

### 4) Salt/ice bath

The salt/ice bath is a modified version of the ice bath. Depending on the type of salt used, salt/ice baths are very useful for producing temperatures ranging from -55 to 0 Celsius. To prepare a salt/ice bath, simply mix the finely crushed ice with 20% of its weight in salt. Salt/ice baths can maintain their temperatures for varying amounts of time depending on the heat evolved during a particular chemical reaction, time, and/or other conditions. In some procedures the salt/ice bath will have to be replaced with a fresh batch. When the salt used is potassium chloride the temperature achieved will be around -10 to 0 Celsius. When the salt used is sodium chloride the temperature achieved will be -20 to 0 Celsius. When the salt used is anhydrous magnesium chloride the temperature achieved will be -30 to 0 Celsius, and when the salt used is calcium chloride hexahydrate the temperature achieved will be -55 to 0 Celsius.

### 5) Dry ice/acetone bath

Dry ice baths are very common in the modern laboratory. Dry ice is readily available and can achieve temperatures of -70 to -30 Celsius. Dry ice is seldom used alone for cooling purposes due to its volatility. It is usually used in combination with a solvent. The solvent is normally acetone, but ethanol, ethyl acetate, or ether can be used. To use a dry ice/acetone bath, add the dry ice to its same weight in acetone (50/50) and then place this mixture into the bath container. Then place this dry ice/acetone filled bath container into a second yet larger container and then fill this second larger container with ice/salt. The second container bath acts like an insulator to the inner bath container giving longer life to the dry ice/acetone bath. The dry ice bath may rapidly deplete if you withhold the second cooling bath. For short-term cooling and use, the second cooling bath will not be needed. For long term cooling, withhold the second cooling bath and place the dry ice/acetone bath into a refrigerator freezer.

### 6) Cooling tricks of the trade

One method of cooling is to place the reaction apparatus into a refrigerator or freezer (as long as the apparatus can fit). This allows for complete cooling without refilling containers with ice or cold water. A major drawback to doing this is a lack of ventilation. In some procedures highly poisonous and corrosive gases are evolved and hence must be properly vented. If a procedure is relatively free from toxic or corrosive emissions, the apparatus can be placed into a freezer or refrigerator if it fits. Refrigerators and freezers are also very handy when having to store reaction mixtures for several hours or several days. Simply place the reaction flask into the refrigerator or freezer and then cool for the amount of time needed. This eliminates the need for ice baths and the like.

## Extraction

Extraction is a major part of many chemical procedures, and is usually conducted before the recrystallization process. Extraction is used to “separate” a product from a reaction mixture. The reaction mixture is merely shaken with a certain solvent multiple times. During this shaking, the desired product in the reaction mixture is dissolved into the solvent. The solvent is then removed from the reaction mixture, and the product recrystallized from the solvent.

The volume of solvent used is dependent on the desired products solubility in it. When the volume of the solvent has been determined, it is broken into small portions, and then each portion is shaken with the reaction mixture independently. After all the portions have been shaken with the reaction mixture, they are combined and then the product is recrystallized. For the chemical procedures in this manual, the solvent, quantity, and volume size of each portion is given in detail.

### Funnel Size

The size of the separatory funnel is of practical consideration when carrying out the extraction process. A separatory funnel is the piece of glass traditionally used in extraction. In order to leave room for shaking the solution the funnel should be 30 to 50% larger than the total combined volume of liquid. For example, use a 250-milliliter separatory funnel when extracting 100 milliliters of reaction mixture with 50 milliliters of solvent. If you are extracting large volumes of liquid, and you don't have a proper sized separatory funnel, simply divide the reaction mixture into smaller portions and do the same for the solvent portions.



**Figure 010. A standard laboratory separatory funnel.**

### Performing the Extraction

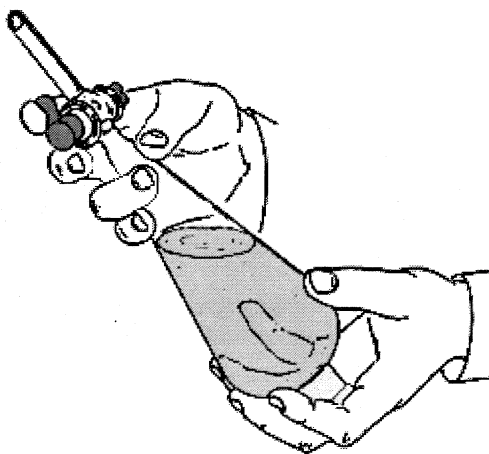
The first step in extraction is to pour the reaction mixture and the solvent into the separatory funnel. A two-layer mixture will result. Which layer is what depends on the densities of the chemicals in the reaction mixture versus the density of the solvent. If the density of the solvent is greater than the chemicals in the reaction mixture, the solvent will be the bottom layer. If the opposite is true, the solvent will be the upper layer. For example, when a water solution is to be extracted with two portions of methylene chloride, the water solution and the first portion of methylene chloride are placed into the separatory funnel (make sure the stopcock is closed). A two-layer mixture results. The methylene chloride will be the bottom layer because methylene chloride is denser than water. Then shake the mixture for several minutes. Afterwards, drain-off the bottom methylene chloride layer only, leaving the water solution in the separatory funnel. After the bottom methylene chloride layer is removed, pour the second methylene chloride portion into the separatory funnel and then begin shaking. Then once again, drain-off the bottom methylene chloride layer. At this point the water solution has been successfully extracted. Both drained-off methylene chloride portions can then be combined (if not already done so), and the product recrystallized. Note: If sulfuric acid is present in the reaction mixture, the methylene chloride will always be the upper layer. Sulfuric acid is denser than methylene chloride. Which layer is what will be described for each extraction process in this book. Certain solvent combinations (a water solution of sodium hydroxide and chloroform) lead to emulsions when shaken together.

Emulsification cannot always be anticipated, so choose the solvent wisely, or wait along time after shaking for the emulsion to dissipate.

1. Place the reaction mixture to be extracted into a separatory funnel (make sure the bottom stopcock is closed).
2. Add the solvent portion slowly to the separatory funnel.
3. Stopper the separatory funnel, and then begin shaking the funnel for a few minutes.
4. After shaking for a few minutes, allow the two layers to completely settle, and then properly vent the funnel as shown in figure 011. Then slightly open the bottom stopcock and slowly drain-off the bottom layer. If the upper layer is the solvent, the bottom reaction mixture layer will have to be drained off first, and then poured back into the same separatory funnel after the upper solvent layer has been drained off. If the bottom layer is the solvent, simply drain it off only, and leave the upper reaction mixture layer.
5. After the appropriate layer or layers have been drained off, and the reaction mixture is the only liquid in the separatory funnel, add the second portion of the solvent and repeat steps 1 through 5.
6. Repeat steps 1 through 5 as many times indicated in the procedure. For example, if an extraction calls for three portions of methylene chloride, conduct steps 1 through 5 three times.
7. After the number of extractions has been completed, combine all drained-off solvent portions (if not already done so).

**Note:** In some cases the reaction mixture will be very dark in appearance, and when extracted, forms another dark appearance with the solvent making the phase boundary between upper and bottom layers hard to see. If this happens, hold the separatory funnel up to a light, or use a flashlight.

**Note:** While shaking the funnel, vapors from the reaction mixture and/or solvent can increase pressure inside the separatory funnel. Proper venting of the separatory funnel is necessary in order to relieve this pressure. To properly vent a separatory funnel, rest the funnel in one hand while grasping the glass stopper. Then tilt the funnel so that the stopcock end is pointed up and away from anyone including yourself. After which rotate the stopcock to the open position. Be certain that the level of the liquid is below the stopcock opening so that none is forced out when the stopcock is opened.



**Figure 011. Correct way of venting a separatory funnel.**

#### Draining the funnel

After shaking the funnel, the layer or layers must be drained off. To do this, simply place the separatory funnel into a ring stand supported by a base support. The stopper must be off in order to drain the funnel, and before opening the stopcock remove the stopper. Attempting to drain the funnel before removing the stopper can result in a vacuum making it difficult to remove the stopper. When draining the bottom layer, the speed should be adequate as to not over drain. Over draining means to accidentally drain-off some the upper layer. The opening of the stopcock (either fully or partially open) is determined as the phase boundary of the upper liquid approaches the stopcock. When the phase boundary is far away, draining can be done rapidly. When the phase boundary approaches the stopcock, the drain speed should be reduced to a drip.

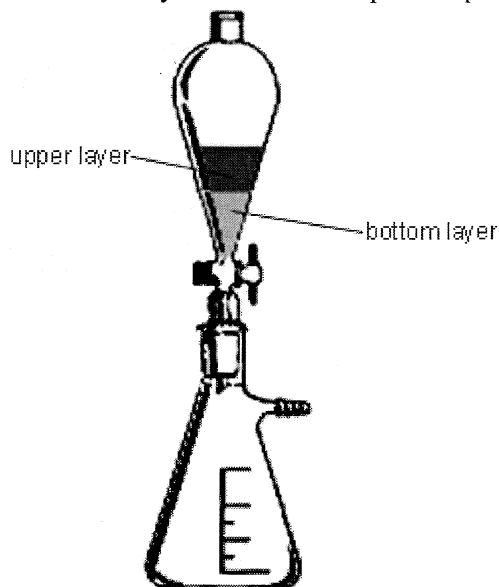


Figure 012. Separatory funnel positioned for draining.

## Salting Out

In some cases, an organic compound (usually a liquid) dissolved in water can be precipitated by the addition of sodium chloride, sodium sulfate, or magnesium sulfate. These salts have a much higher affinity for water than most organic compounds, so they tend to dissolve in the water leaving the dissolved organic compound with no room to remain dissolved. The lack of space causes the organic compound to precipitate (organic liquids form a second layer). Water solutions of isopropyl alcohol for example, can be salted out by the addition of sodium chloride to the mixture followed by rapid shaking of the mixture. The quantity of sodium chloride used is determined by the alcohol concentration. The weaker the concentration is, the more salt is needed. After shaking, a two-layer mixture results. The isopropyl alcohol will be the top layer, and the brine solution the bottom.

## Recrystallization, product recovery, and filtration

Recrystallization is a very important tool for purifying solids. In recrystallization, solubility differences allow solids to be separated from each other and recovered from the solvent. In the recrystallization process, molecules slowly deposit from solution and attach to each other to form crystals. As the aggregates of crystals grow large enough, they precipitate. After precipitation, the solids can be recovered by filtering them off.

Choosing the appropriate solvent is the most crucial aspect of the recrystallization process. The best solvent for recrystallization is one in which the material is less soluble at room temperature but more soluble when hot. At higher temperatures, solvents that form super saturated solutions with certain solids meet this requirement.

Solvent choice is also governed by another important factor, the ease of solvent removal. Solvents with low boiling points are preferred because their removal is easy. A third consideration in selecting a solvent is the temperature at which the solvent solidifies. Benzene was once widely used in recrystallization, but when placed in an ice bath, crystals of benzene would also precipitate (benzene crystallizes at 6 Celsius). A final consideration in choosing a solvent is reactivity. Obviously a solvent that reacts with a solid cannot be used for recrystallization.

Recrystallization depends on super saturation. Super saturated solutions are formed when mixtures containing the dissolved solid and the solvent (or solvent mixture) are heated, or evaporated. When the mixture is heated, the solvent begins to evaporate, as the evaporation proceeds, the concentration of the dissolved solid(s) begins to increase. During this evaporation, the solids become *over dissolved* leading to the super saturated solution. When tiny crystals start forming on the surface of the mixture during heating, super saturation has been reached. When the supersaturated solution is cooled, recrystallization begins and some of the dissolved solid precipitates as crystals. Not all the solid will precipitate out on cooling. After the supersaturated solution has cooled for some time, equilibrium sets in restoring the original solubility of the mixture. The only difference is that some of the solvent and solid have been removed. The precipitated crystals are then collected by filtering the mixture. To recover more solid, the mixture must be re-heated and allowed to evaporate to the point of super saturation again.

The recrystallization process

## Chapter 1: Laboratory tutorial on techniques and procedures

The recrystallization process is simple. Boil the mixture that contains the dissolved product and the solvent (or solvent mixture). The mixture can be placed into a distillation apparatus and distilled at the boiling point of the solvent to collect the solvent. Using a distillation apparatus is preferred rather than just boiling-off the solvent, which would be a waste of solvent. Boil off the solvent until super saturation is achieved. When tiny crystals begin to form on the surface of the mixture, super saturation has been achieved. Then remove the heat source (turn off the heat source) and allow the mixture to cool to room temperature. Afterwards, place the mixture into a cold-water bath or ice bath for thirty minutes. After which, remove the cooling bath, and then filter-off any precipitated product. Then place the filtered mixture back into the same distillation apparatus, and re-distill again until a super saturated solution is achieved. When super saturation is achieved, remove the heat source, and allow the mixture to cool to room temperature. Afterwards, place the mixture into a cold-water bath or ice bath for thirty minutes. Then remove the cooling bath, and then filter-off any precipitated product. Then place the filtered mixture back into the same distillation apparatus, and distill until a super saturated solution is achieved. When it is achieved, remove the heat source, and allow the mixture to cool to room temperature. After which, place the mixture into a cold-water bath or ice bath for thirty minutes. Then filter-off any precipitated product. At this point much of the solvent has been removed by distillation, and much of the product has been recovered. The remaining mixture is called the mother liquor, and can be recycled to a future recrystallization of the same product (using the same solvent or solvent mixture). This process of boiling, cooling, and filtering should be repeated as many times as necessary. When recrystallizing a product from a solvent or solvent mixture, continue the process until 90% of the solvent has been removed. Depending on the solubility of the product, continue the recrystallization process until 75 to 98% of the solvent has been removed. After most of the product has been collected, it can then be washed. To wash a solid product, simply leave it in the filtering funnel, and then pass an inert solvent over it many times. Choose a solvent that does not dissolve the product. Water is usually used to wash organic solids.

### Seed Crystals

In some cases recrystallization of super saturated solutions can be initiated with a seed crystal. A seed crystal is simply a small crystal of the product. It is added to the super saturated solution, and the dissolved product begins to grow on the seed crystal. The seed crystal induces recrystallization by giving the dissolved product a surface from which to grow on. The recrystallization of the product stops when equilibrium of the solution is reached.

### Recovering the product through low heat or no heat evaporation

In most modern labs, the recrystallization process is passed over by a rotary evaporator. A rotary evaporator, as pictured in figure 005, is the most common method of recovering dissolved product. To use, the reaction mixture is placed there into, and then a vacuum is applied. The flask containing the reaction mixture is partly submerged in a water bath, and the necessary amount of heat is applied. Because liquids have decreased boiling points with decreasing pressure, solvents can be removed at much lower temperatures thanks to the vacuum. This process is similar to vacuum distillation. The great thing about rotary evaporators is their ability to run for hours on end without having to interact, monitor, or take part in the process. Simply insert the reaction mixture, apply the necessary heat, attach the vacuum, and let the machine do the rest of the work. Rotary evaporators sell for about \$3,000 to \$10,000 a piece. The oldest method of product recovery is placing the reaction mixture into a crystallizing dish, or shallow pan, and then allowing the solvent(s) to air evaporate. This method is a good idea for crystallizing stable, light insensitive products, where good crystal size is desired; for example, allowing a solution containing sodium chlorate to air-evaporate, large brilliant crystals of the chlorate are obtained. If this same solution was recrystallized, or evaporated under vacuum, usually small crystals of the chlorate are obtained. The problem with air-evaporation is the amount of time required, especially if the product is hygroscopic. In some examples, air-evaporation is impossible. Examples include zinc chloride, lithium perchlorate, and calcium chloride. These substances are so hygroscopic that placing the dry crystals into a beaker will produce a self-induced aqueous solution on standing after several days or weeks due to moisture absorption from the air. In warm dry climates, such as desert climates, air-evaporation has its advantages. Good crystal size can be rapidly achieved by allowing reaction mixtures to air-evaporate in the sunlight.

## Filtration

Filtration and recrystallization run hand in hand. When a product precipitates, it must be collected. Filtration is the most common method of collecting precipitated products. The two methods of filtration include gravity, and vacuum. Vacuum filtration is the most common method of filtering in the lab, and it is also the fastest.

### 1) Gravity filtration

Gravity filtration is the oldest and slowest method of filtering. In most regards gravity filtration should be avoided due to the slow nature. In many examples gravity filtration can take hours, and even days. Even so, gravity filtration is useful for removing charcoal, which is difficult to remove from mixtures when using vacuum filtration.

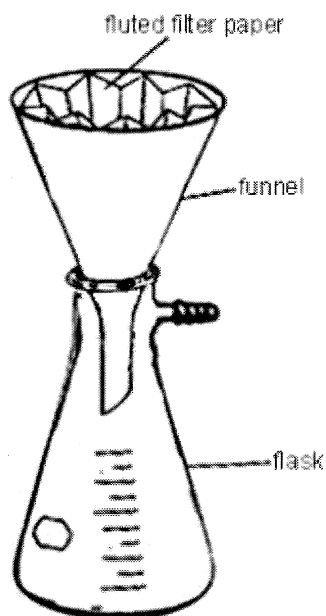


Figure 013. Apparatus for gravity filtration.

Gravity filtration is sometimes used to remove impurities rather than to collect a precipitated product. In this case the filtration takes place with the use of a filter aid. A filter aid is an insoluble substance used to absorb impurities. Some examples of filter aids include Celite, silicon dioxide, sand, zeolites, and even pebbles. Celite is a diatomaceous earth material that is most commonly used. Although filter aids can be used to speed up the filtration of finely divided precipitates, which otherwise get stuck in the tiny holes of the filter paper.

#### Fluting Filter Paper

Laboratory filter paper used in modern labs is usually circular in nature, so fluting the paper is necessary. Fluted filter paper is superior to flat filter paper because fluted filter paper allows for better airflow between the funnel wall and the fluted filter paper.

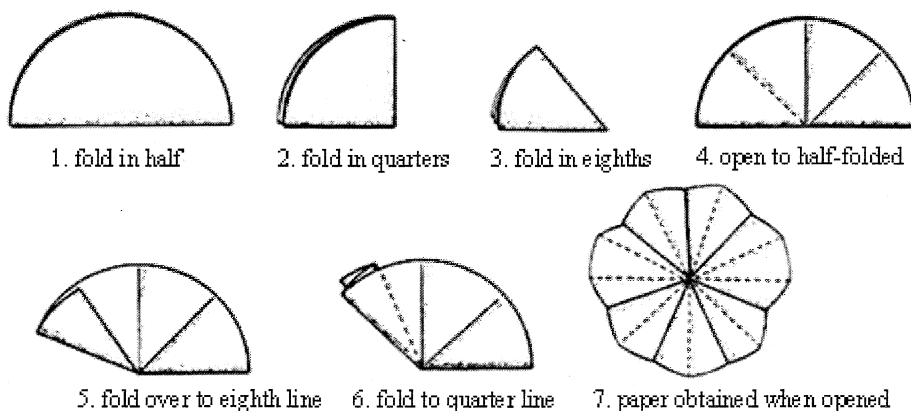


Figure 0014. Fluting filter paper.

#### 2) Vacuum Filtration

Vacuum filtration is definitely the method of choice for filtration, and it is the most common method. Vacuum filtration is superior in that suction is used to force the liquid through the filter paper allowing for rapid filtration. Precipitates can be recovered quickly and easily. After the precipitate has been recovered, it can then be vacuum dried. Vacuum drying is simply allowing suction to continue after the liquid has been removed. The suction creates an excellent airflow, which dries the collected precipitate as it flows. Ten to twenty minutes is adequate time to dry any product.



## Chapter 1: Laboratory tutorial on techniques and procedures

When first starting the filtration process, the vacuum will suck some of the product into the flask. The contents of the flask should then be re-filtered to ensure no product loss. The suction force is generated by a vacuum pump, which is commercially available in many styles and sizes; hand driven pumps can be used as well. Note: The suction force should not be too great. Placing your hand completely over the funnel until the suction grips your hand moderately indicates the proper suction. Never underestimate the power of a vacuum.

A Buchner funnel is used in vacuum filtration, and is a glass or plastic funnel. Plastic Buchner funnels are composed of two pieces. The funnel cup makes up the top piece, and the stem makes up the bottom piece. Glass Buchner funnels are composed of one or two pieces, and some come with glass joints. To use the funnel simply attach it to the filtering flask (see illustration below), and then place a piece of round filter paper into the bottom of the funnel. The filter paper is simply held in place by gravity and the suction force. Before filtration begins, lightly moisten the filter paper with water or fresh solvent (the solvent used should be the same as in the mixture being filtered, or an inert solvent that does not dissolve the precipitate). Once the precipitate has been filtered and dried, simply remove the suction source and then casually remove the filter paper from the Buchner funnel. Then gently scrape off the product from the filter paper.

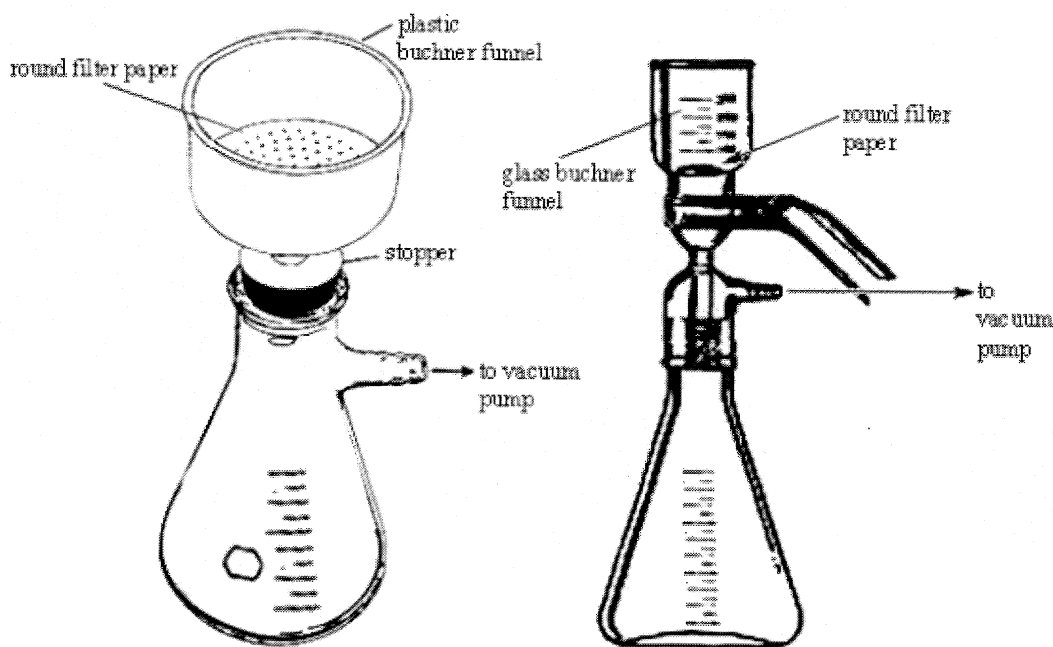
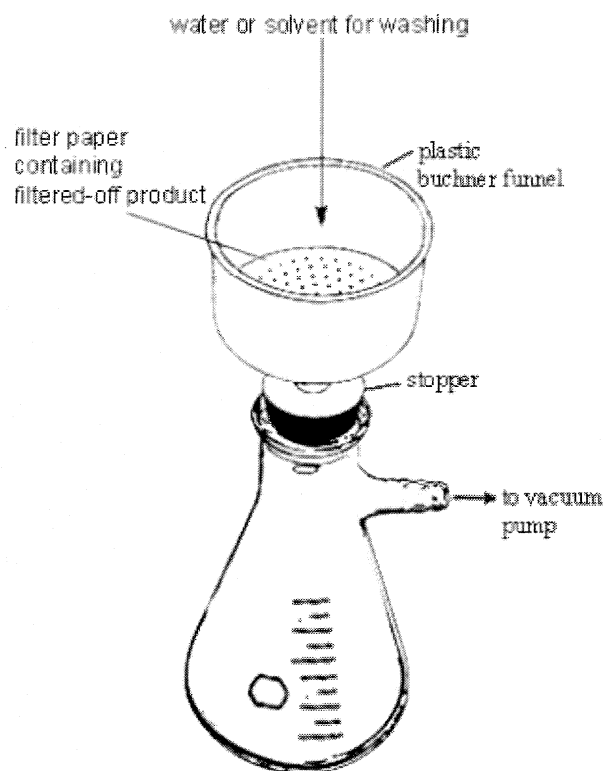


Figure 015. Left: Plastic buchner funnel. Right: All glass set-up.

### Washing liquids and solids

Solids are easily washed by passing water, or the desired solvent over the solid product, which is contained in the filter funnel. For washing solids in this way, vacuum filtration should be used. Washing solids in this way using gravity filtration is a long and time consuming process. Obviously, do not wash the filtered-off solid with any liquid that reacts with, or dissolves the solid product.



**Figure 016. Washing a solid product.**

Another method of washing a solid product is to place it into a beaker, and then add an excess of water or solvent, stirring the mixture for several minutes, and then allowing the mixture to stand long enough for the solid product to settle. After the solid product settles, much of the water above the settled solid product can be removed by carefully tilting the beaker, and pouring it off. This method of washing is useful for washing large amounts of water-insoluble product.

Washing liquids is done in a similar manner as just described. For washing a liquid, usually with water, place the liquid into a beaker, and then add the desired amount of water. Thereafter, stir the mixture for several minutes, and then allow the mixture to stand. After the two-phase mixture has settled, remove the water layer either by using a separatory funnel, or by pouring it off.

### **Drying agents and drying liquids**

Water is called the universal solvent, but in many cases its considered to be an impurity. After the extraction process, the combined solvent portions sometimes contain a small amount of water. This water is removed by treating the combined solvent portions with an inert drying agent. The drying agent simply absorbs the water. The most commonly used drying agents are listed below.

#### **1) Anhydrous sodium sulfate**

Anhydrous sodium sulfate is the most common general-purpose drying agent. It is inexpensive and has a very large capacity of absorption because it can form a decahydrate. Anhydrous sodium sulfate is relatively inert, and it does not react with most organic compounds. Anhydrous sodium sulfate can be regenerated from used sodium sulfate by heating to 200 Celsius for 1 hour.

#### **2) Anhydrous magnesium sulfate**

Anhydrous magnesium sulfate is the second most commonly used drying agent. Similar to anhydrous sodium sulfate, it to has a high capacity for absorption, and low cost. Although unlike anhydrous sodium sulfate, it has a faster drying rate, but is more reactive. It can be regenerated in the same manner as anhydrous sodium sulfate.

#### **3) Calcium chloride**

Calcium chloride is very inexpensive, and is an excellent drying agent. Its very high capacity and rapid drying ability makes it the reagent of choice for drying hydrocarbons, chlorinated solvents, halogens, and ethers. Unfortunately, calcium chloride is much more

reactive than either sodium or magnesium sulfate and thus cannot be used to dry amines, alcohols, acid gases, or ammonia. It can be regenerated in a similar manner as anhydrous sodium sulfate.

## Distillation

Distillation is a very common method for purifying liquids. Atmospheric distillation (general distillation), vacuum distillation, and steam distillation are the three common methods of distillation. Atmospheric distillation takes place at atmospheric pressure, which means the distillation apparatus is open to the air. Vacuum distillation utilizes reduced pressure to distill a liquid at lower temperature. Vacuum distillation is commonly used to distill liquids, which tend to decompose at their atmospheric boiling points. Vacuum distillation is also used to conveniently distill liquids with relatively high boiling points at a much more efficient temperature. Steam distillation is similar to atmospheric distillation, but steam is used to promote volatility. Steam distillation only works on liquids or solids which are volatile with steam.

### 1) Atmospheric Distillation (general distillation)

Atmospheric distillation is the most common of the three methods of distillation. Figure 017 illustrates a common distillation apparatus. When liquids are heated they become volatile. The degree of volatility depends on the amount of heat applied to the liquid, the pressure, and the chemicals boiling point. When enough heat is applied to the liquid, the liquid begins to boil. When a liquid boils, intermolecular forces within the liquid break, and the molecules there after convert into the gas phase. During the distillation, this gas passes over into a condenser, where it is condensed back into a liquid by applying a cooler temperature to the gas. A condenser usually filled with circulating cold water acts as the cooling force. When the gas is cooled, it reforms back into a liquid, and then gravity pulls it into a receiver flask where it collects. A typical distillation produces 1 to 50 milliliters of liquid per minute. Most distillations take hours, depending upon the volume of liquid being distilled, and the concentration. Concentrated solutions distill much faster than dilute ones.

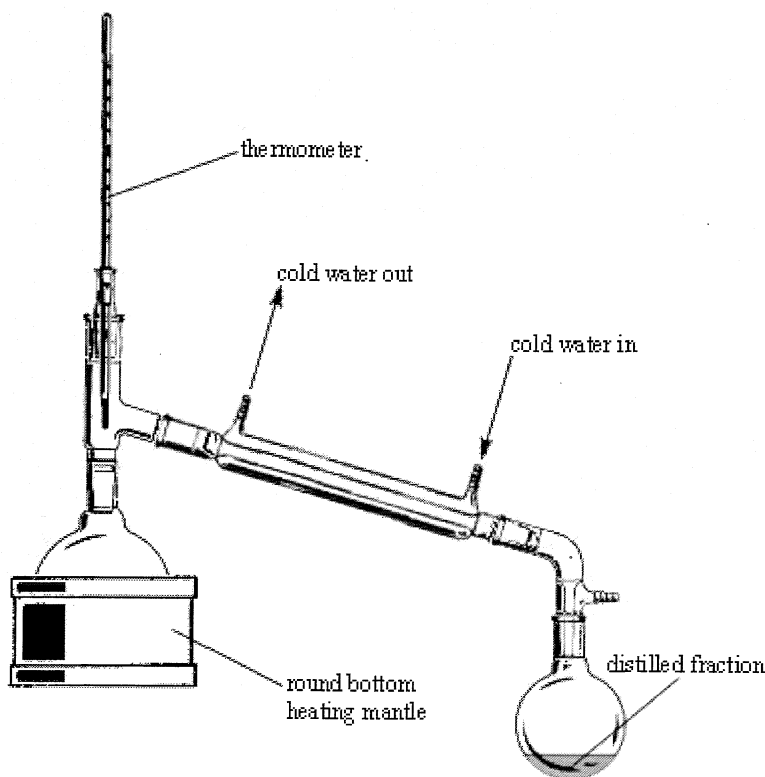


Figure 017. Atmospheric distillation apparatus.

### 2) Vacuum Distillation

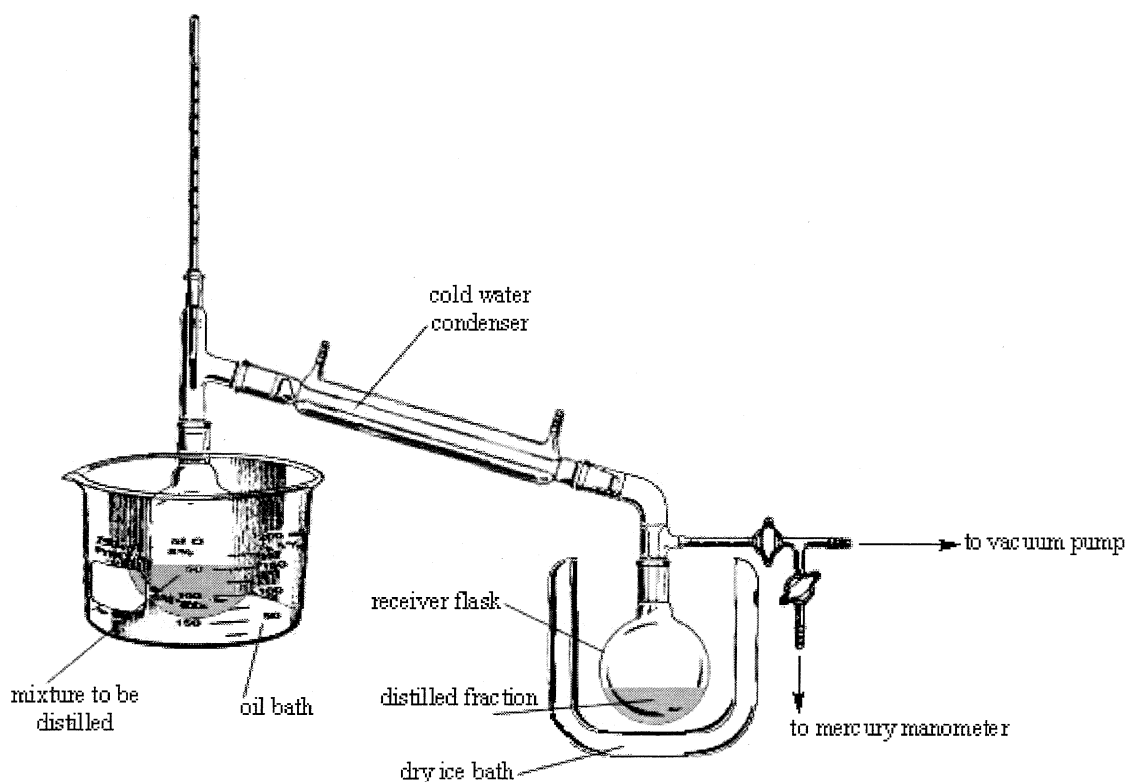
Vacuum distillation is another common method of distillation, and is very useful in the purification of chemical warfare agents. Many warfare agents have boiling points that make purification through ordinary distillation difficult. Many agents begin to decompose at their normal boiling points, so vacuums need to be applied to lower them. Vacuum distillation takes advantage of the volatility of liquids by reducing pressure. The boiling points of liquids decrease with decreasing pressure, so distillation of heat sensitive liquids

## Chapter 1: Laboratory tutorial on techniques and procedures

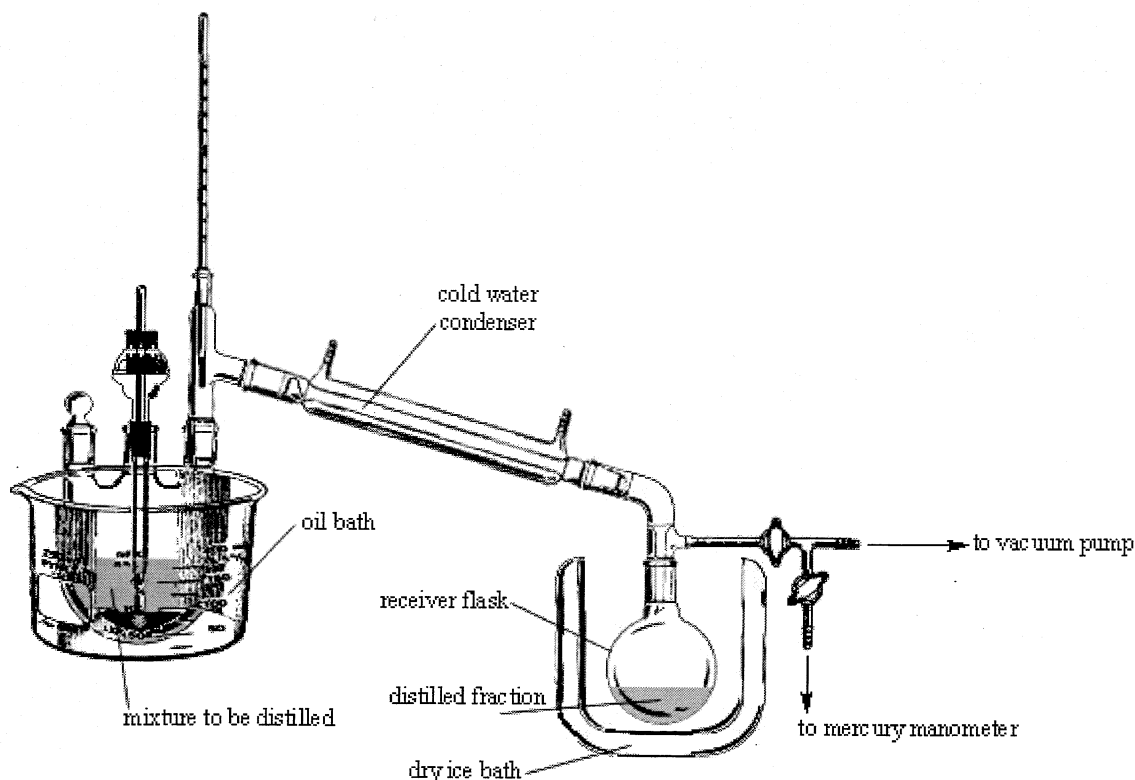
can be carried out at lower temperatures. Note: some liquids begin to decompose at their atmospheric boiling points, so purification using general distillation will not work. Vacuum distillation is also commonly used for distilling liquids at lower temperatures. When a vacuum is applied to the apparatus, reduced pressure forces the liquid or liquids to volatilize much more readily. As a result, less heat is needed to force the liquid or liquids into the gas phase. For example, at sea level (atmospheric pressure), water boils at 100 Celsius, but at 15,000 feet water boils at 92 Celsius. It is possible to reduce the pressure of a distillation apparatus to a point where water boils at 50 Celsius. Nevertheless, when using laboratory glassware, the strength of the vacuum is limited. An absolute vacuum using lab glass is impossible due to outside forces. If we applied an absolute vacuum to a glass distillation apparatus, it would implode. Vacuums as low as 0.01 millimeters of mercury are possible using thick walled stainless metal apparatus.

Vacuum distillation can be carried out using rotary evaporators or vacuum distillation apparatus. Rotary evaporators are the best at removing solvents under mild vacuums, but higher vacuum require vacuum distillation apparatus. Vacuum distillation apparatus must be connected to mercury manometers to monitor the pressure. Mercury manometers are very common, and readily available; for a price. The receiver flasks employed in vacuum distillation should be submerged in cooling baths, preferably dry ice or temperatures ranging from 0 to -30 Celsius. If cooling baths are not used, the volatilized vapor will not be condensed nor collected in the receiver flask, as the vacuum will suck this volatilized vapor into the pump. Note: The male glass joints of all the adapters should be coated with vacuum grease so as to make removal easier. Applying a vacuum to the systems without the vacuum grease can result in severe suction between male/female connections making disconnection almost impossible.

For heating mixtures to be distilled, a steam bath or oil bath is preferred for better temperature control. Hot plates and heating mantles can be used, but with less control of heating and surface areas.



**Figure 018. Common vacuum distillation apparatus. Oil immersion heater not shown. A mercury monometer is connected to the system to monitor the vacuum. A common mercury manometer can read vacuums down to 1 millimeter of mercury or less.**

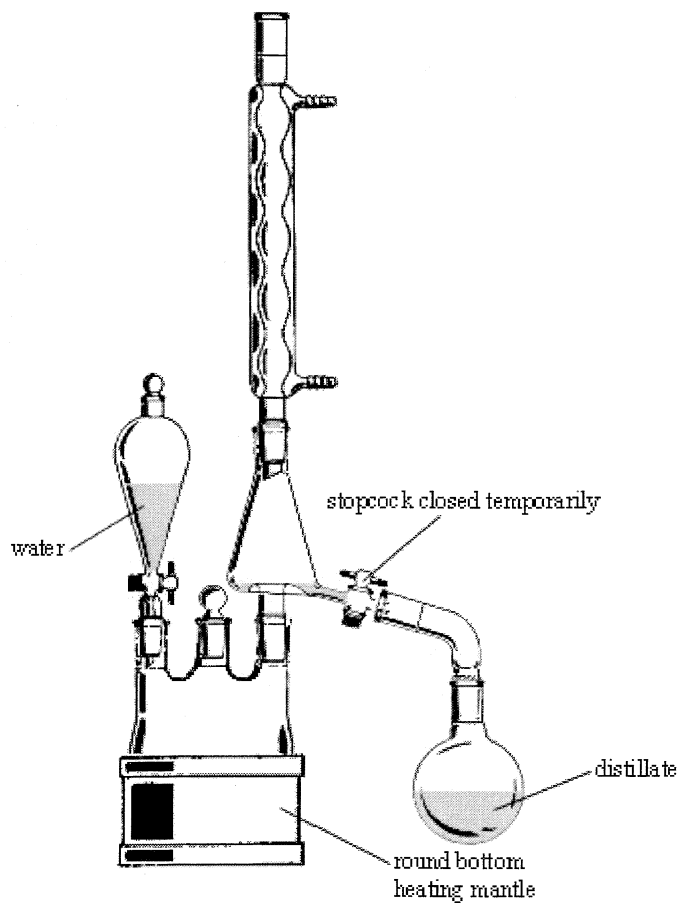


**Figure 019. Common vacuum distillation apparatus with electric stirrer. A mercury monometer is connected to the system to monitor the vacuum. A common mercury monometer can read vacuums down to 1 millimeter of mercury or less. Note: The oil bath is pictured without the immersion heater.**

### 3) Steam Distillation

Steam distillation is the third most common method of distillation. Figure 020 illustrates a common steam distillation apparatus. Steam distillation takes advantage of the volatility force of water upon certain solids or liquids. Many liquids and solids are volatile with steam, which means they partially volatilize when contacted with steam without actually converting to gas. The steam merely acts as a carrier picking up the solids or liquids, and then carrying them over in a conventional distillation manner. The products being steam distilled, whether soluble in water or not, are collected in the receiver flask.

Steam distillation works by the interference of hot gases upon solids or liquids. The solids partially volatilize forming finely divided micro particles, and liquids partially volatilize forming micro sized droplets of liquid (a mist). The gaseous water then takes-up these finely divided micro particles or small droplets of liquid, and carries them over in a conventional distillation manner. Think of smoke for example, it appears to be a smooth flowing gas when actually it's a mixture of finely divided micro particles mixed in with colorless gases. Most steam distillation apparatuses generate their steam internally, but some use steam provided from a steam line.

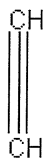


**Figure 020. Common steam distillation apparatus with steam generated internally.**

Note: All the glassware represented in the illustrations can be purchased from *Lab Glass Inc. PO Box 688, Buena, NJ 08310 USA*. Lab Glass is by far one of the best manufacturers and suppliers of laboratory glassware in North America.

## Chapter 2: Reference guide

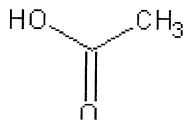
### Acetylene



Acetylene

Acetylene is a colorless gas, which has a pleasant odor when pure, but a disagreeable odor when impure. It has a melting point of  $-81$  Celsius, and liquefies at  $0$  Celsius under  $21$  atmosphere of pressure. The gas is easily liquefied under pressure. Acetylene gas is not explosive under normal pressures, but it forms explosive mixtures under pressure. It reacts with copper forming dangerous explosive compounds, and it should be stored in steel cylinders. The gas is slightly soluble in water, alcohol, and glacial acetic acid. Acetylene is soluble in ether and benzene. It is prepared by reacting water with calcium carbide, which is produced by the destructive distillation of coal with lime.

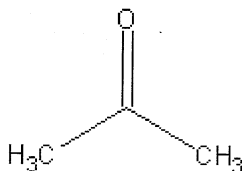
### Acetic acid, Glacial. *Pure acetic acid*



Acetic acid

Glacial acetic acid is a colorless liquid with a pungent odor. Glacial acetic acid is a corrosive liquid with a boiling point of  $118$  Celsius, and a melting point of  $17$  Celsius. Glacial acetic acid is a flammable liquid. It is an excellent solvent for many organic compounds, and is miscible with water, alcohol, glycerol, ether, and carbon tetrachloride. Glacial acetic acid weakly ionizes in water solutions. It can be made by the destructive distillation of wood, and subsequent condensation of the vapors (methanol is a by-product and hence must be separated by distillation). Glacial acetic acid is a common commercially available chemical. *Wear gloves when handling glacial acetic acid because it can cause skin irritation and possible skin burns.*

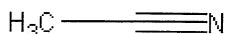
### Acetone



Acetone

Acetone is a very volatile, highly flammable liquid with a rather characteristic odor, and a pungent, sweetish taste. It has a boiling point of  $56$  Celsius and a melting point of  $-94$  Celsius. Acetone is miscible with water, alcohol, chloroform, ether, and most oils. Acetone will dissolve many plastics, and resins. Keep acetone away from plastic eyeglass frames, jewelry, pens and pencils, rayon stockings, and other rayon garments. It is mildly irritating, and fumes produce dizziness, and headaches. Use proper ventilation when handling acetone. Acetone is prepared by the oxidation of isopropyl alcohol with potassium dichromate, and on an industrial scale by the oxidation of cumene with air. Acetone is a very common and widely available solvent.

### Acetonitrile

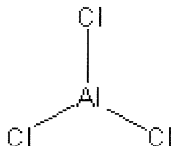


Acetonitrile

## Chapter 2: Reference guide

Acetonitrile is a colorless liquid with an ether-like odor. Acetonitrile is a toxic liquid, and can be absorbed through the skin. It is flammable and burns with a luminous flame. It has a melting point of  $-45$  Celsius, and a boiling point of  $82$  Celsius. It is miscible with water, methanol, methyl acetate, ether, chloroform, carbon tetrachloride, and many unsaturated hydrocarbons. Acetonitrile is an excellent solvent that dissolves many inorganic salts. It forms a constant boiling mixture with water (84% acetonitrile with a boiling point of  $76$  Celsius). Acetonitrile occurs in coal tar, and is a widely available commercial chemical. *Wear gloves and use proper ventilation when handling acetonitrile. Acetonitrile is toxic by inhalation or skin absorption.*

### Aluminum chloride, Anhydrous



Aluminum chloride

Anhydrous aluminum chloride is white when pure, but is ordinarily a gray or yellowish powder, which fumes in air, and has a strong hydrogen chloride odor. Anhydrous aluminum chloride volatilizes when heated in small quantities. It combines with water with explosive violence and liberation of much heat. Anhydrous aluminum chloride is very soluble in most organic solvents. Anhydrous aluminum chloride is a powerful catalyst for the halogenation of organic compounds. It is prepared by passing dry hydrogen chloride gas over finely divided aluminum.

### Ammonium fluoride



Ammonium fluoride

Ammonium fluoride forms deliquescent crystal leaflets or needles, which decompose when heated into ammonia and hydrogen fluoride gases. The commercial grade is sold as a granular powder. The dry solid should be stored in plastic containers as it corrodes glass upon prolonged storage. Ammonium fluoride is unstable, and it decomposes by hot water into ammonia and ammonium bifluoride. Water solutions are corrosive and etch glass. Ammonium fluoride is obtained by passing ammonia gas into ice cooled 40% hydrofluoric acid.

### Antimony



Antimony

Antimony is a silvery-white lustrous brittle metal, which forms hard scale-like crystals. Some forms of antimony are dark-gray in appearance. It is not tarnished by air, and is not attacked by dilute acids. The metal has a melting point of  $630$  Celsius, and a boiling point of  $1635$  Celsius. Some forms of antimony may melt at  $1440$  Celsius. Antimony is prepared on an industrial scale from reduction of flue dusts, and slag's. It can be prepared in the lab by heating antimony oxide with potassium cyanide.

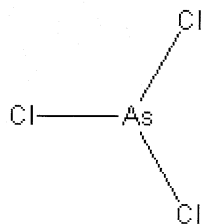
### Arsenic



Arsenic

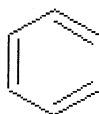
Arsenic forms three allotropic forms:  $\alpha$ -form, which forms steel-gray metallic crystals with a brilliant and shiny tint. The beta form forms a dark gray amorphous solid, and it transforms to the alpha form when heated to  $280$  Celsius. The third modification is a black solid. The alpha form is the most common, and it sublimes when heated to  $615$  Celsius. Its melting point under 36 atmospheres of pressure is  $818$  Celsius. Arsenic is a major by-product in many industrial processes including smelting ores and metal refining. Its chief natural sources are realgar, orpiment, and arsenolite. Commercial arsenic is prepared by sublimation of arsenic in a stream of nitrogen gas. Pure arsenic tarnishes on exposure to air forming a thin coating of arsenic trioxide. Arsenic is a suspected carcinogen, so avoid inhalation of dust, and skin contact.



**Arsenic trichloride**

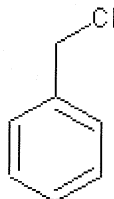
Arsenic trichloride

Arsenic trichloride is a colorless to slightly colored fuming liquid, which is very poisonous. It has a melting point of  $-16$  Celsius, and a boiling point of  $130$  Celsius. It reacts with water forming hydrogen chloride and arsenous acid. It is slowly decomposed by sunlight. Arsenic trichloride is miscible with chloroform, ether, oils, and fats. It dissolves iodine, phosphorus, and sulfur. It is prepared by passing chlorine over arsenic pieces, followed by fractional distillation. Note: The arsenic pieces can be placed into methylene chloride, or chloroform, and the chlorine gas then bubbled there into to form the arsenic trichloride, which remains dissolved in the solvent. *Note: Arsenic trichloride is very poisonous, and skin contact, ingestion, and inhalation should be avoided at all cost.*

**Benzene**

Benzene

Benzene is a clear, colorless, volatile, highly flammable liquid. Benzene is toxic, and a carcinogen. It has a boiling point of  $80$  Celsius, and is miscible with alcohol, chloroform, ether, carbon disulfide, and carbon tetrachloride. It is insoluble in water. Keep benzene in tightly sealed glass bottles, and store in a cool area. Benzene is a common well known solvent, which is readily available commercially. *Use proper ventilation when handling benzene. Inhalation of benzene vapors is hazardous.*

**Benzyl chloride**

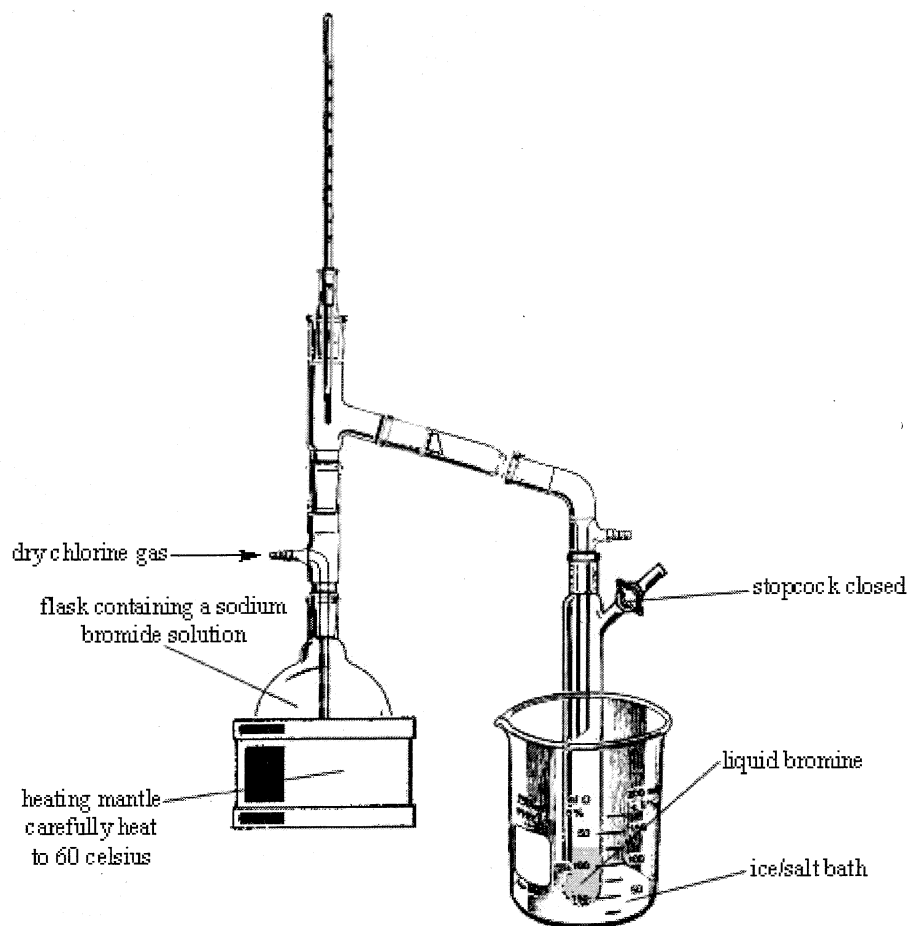
Benzyl chloride

Benzyl chloride forms a colorless liquid with an unpleasant and irritating odor. It has a melting point of  $-48$  Celsius, and a boiling point of  $179$  Celsius. It is miscible with alcohol, chloroform, and ether. Benzyl chloride rapidly decomposes when heated in the presence of iron. It can be made by the carefully controlled chlorination of toluene in the presence of sunlight.

**Bromine**

Bromine

Bromine is a dark red, highly fuming liquid, which is very volatile. Its fumes are toxic, corrosive, and strongly irritating. Bromine has a melting point of  $-7$  Celsius, and a boiling point of  $59$  Celsius. It is insoluble in water, but freely soluble in alcohol, ether, chloroform, and carbon disulfide. It is soluble in alkali bromide solutions. Bromine is less reactive than chlorine, but just as toxic. Keep bromine stored in glass stoppered bottles, and store in a cool place (refrigerator) away from sunlight. Bromine is prepared by passing chlorine gas into a solution of sodium bromide, and then simultaneously evaporating the bromine. The bromine vapors are then condensed. Bromine is commercially available but shipping regulations may restrict its sale.



**Figure 021. Apparatus for preparing bromine. The bromine should be re-distilled at 60 Celsius.**

### Calcium chloride, Anhydrous



#### Calcium chloride

Anhydrous calcium chloride forms cubic crystals, granules, or fused masses, which are very hygroscopic. Anhydrous calcium chloride has a melting point of 772 Celsius, and a boiling point of 1600 Celsius. It is freely soluble in water and alcohol with evolution of much heat. It absorbs moisture from the air, and can be used to dry gasses and liquids such as halogens, hydrogen, oxygen, nitrogen, and organic solvents (except ammonia, sulfur oxides, nitrogen oxides, hydrogen sulfide, and acids which chemically react). Anhydrous calcium chloride is obtained as a by-product in the ammonia-soda (solway) process, and is a readily available commercial chemical. The hydrates of calcium chloride are converted into anhydrous calcium chloride by heating to 200 Celsius for 1 hour. Anhydrous calcium chloride and its hydrates are sold in many stores as ice melters. This ice melting product contains a mixture of anhydrous, and dihydrate calcium chloride. Heat this product to 200 Celsius for 1 hour to obtain straight anhydrous calcium chloride.

### Carbon monoxide



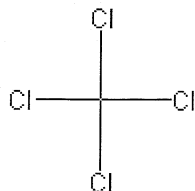
#### Carbon monoxide

Carbon monoxide is a colorless, odorless gas with a melting point of -205 Celsius, and a boiling point of -191 Celsius. It is highly poisonous and is an effective blood agent as it binds with oxygen carriers within the blood stream. The gas is flammable, and burns to carbon dioxide. Carbon monoxide is insoluble in water, but soluble in solutions of cuprous chloride in the presence of hydrochloric

## Chapter 2: Reference guide

acid, and in concentrated ammonia solutions. The gas dissolves to moderate extents in ethyl acetate, chloroform, and acetic acid. Carbon monoxide is highly toxic and inhalation should be avoided under all circumstances. Use proper ventilation when handling. Carbon monoxide is a major by-product in the production of iron from blast furnaces, as it is produced upon reduction of iron ores with coke and lime. It is also produced as a product from incomplete combustion of natural gas.

### Carbon tetrachloride



Carbon tetrachloride

Carbon tetrachloride is colorless, heavy, non-flammable liquid with a characteristic odor. It has a boiling point of 78 Celsius, and a melting point of -23 Celsius. Carbon tetrachloride is insoluble in water, but miscible with alcohol, benzene, chloroform, ether, and carbon disulfide. Carbon tetrachloride is a potential poison, and inhalation, ingestion, and skin absorption should be avoided at all cost. Carbon tetrachloride may be a carcinogen. It is prepared on an industrial scale by the chlorination of methane, but can be conveniently prepared by reacting chlorine with carbon disulfide in the presence of iron fillings; the carbon tetrachloride is recovered by distillation.

### Chlorine gas



Chlorine gas

Chlorine gas is a yellow gas with a suffocating, and strongly irritating odor. It has a melting point of -101 Celsius, and a boiling point of -34 Celsius. Chlorine is sold as a compressed gas in steel cylinders. It is insoluble in water and not very soluble in alcohol, but soluble in dry benzene, and toluene. Chlorine combines readily with all elements except the noble gases, hydrogen, oxygen, and nitrogen. Chlorine does not occur naturally, but occurs in combined form as chlorides. It occurs in nature (in the form of chlorides) as sodium chloride, potassium chloride, and magnesium chloride. Many finely divide metals will burn in a chlorine atmosphere. Chlorine is a toxic gas, which can be fatal if inhaled for prolonged periods of time. Inhalation of mild quantities of chlorine causes nose and throat irritation followed by excessive mucous congestion in the nose. Chlorine is a corrosive gas, which will react with many metals on contact. It is a strong oxidizer and is capable of oxidizing a great many inorganic compounds. Chlorine will explode in contact with hydrogen if direct sunlight is present. Chlorine should be protected from sunlight. It is the 10<sup>th</sup> largest chemical manufactured in the US. It was used as a chemical warfare agent in WWI, but due to its lack of toxicity, and poor environmental capacity (dissipates rapidly), its use has ended. Chlorine is prepared on an industrial scale from the electrolyses of sodium chloride brine in a system called the chloro-alkali process (sodium hydroxide is a useful by-product). It can be prepared in the lab by reacting hydrochloric acid with calcium hypochlorite or liquid bleach (Clorox), by the electrolysis of hydrochloric acid, or by using a diaphragm cell. Note: In the electrolysis of hydrochloric acid, hydrogen gas is also produced. Despite the presence of this hydrogen, the chlorine can be directly used in chemical reactions because the hydrogen acts more like an inert gas. The chlorine does not react with this hydrogen, even if the gas mixture is moderately hot. **Warning:** If the apparatus is exposed to direct sunlight, detonation will occur. Chlorine explodes when mixed with hydrogen and exposed to sunlight. The detonation propagates downwards, so there is no immediate danger from fragments. As a reminder, the electrolysis of hydrochloric acid is perfectly safe as long as the apparatus is protected from direct sunlight, magnesium light, halogen lamps, or UV lamps (cover all windows, ect.).

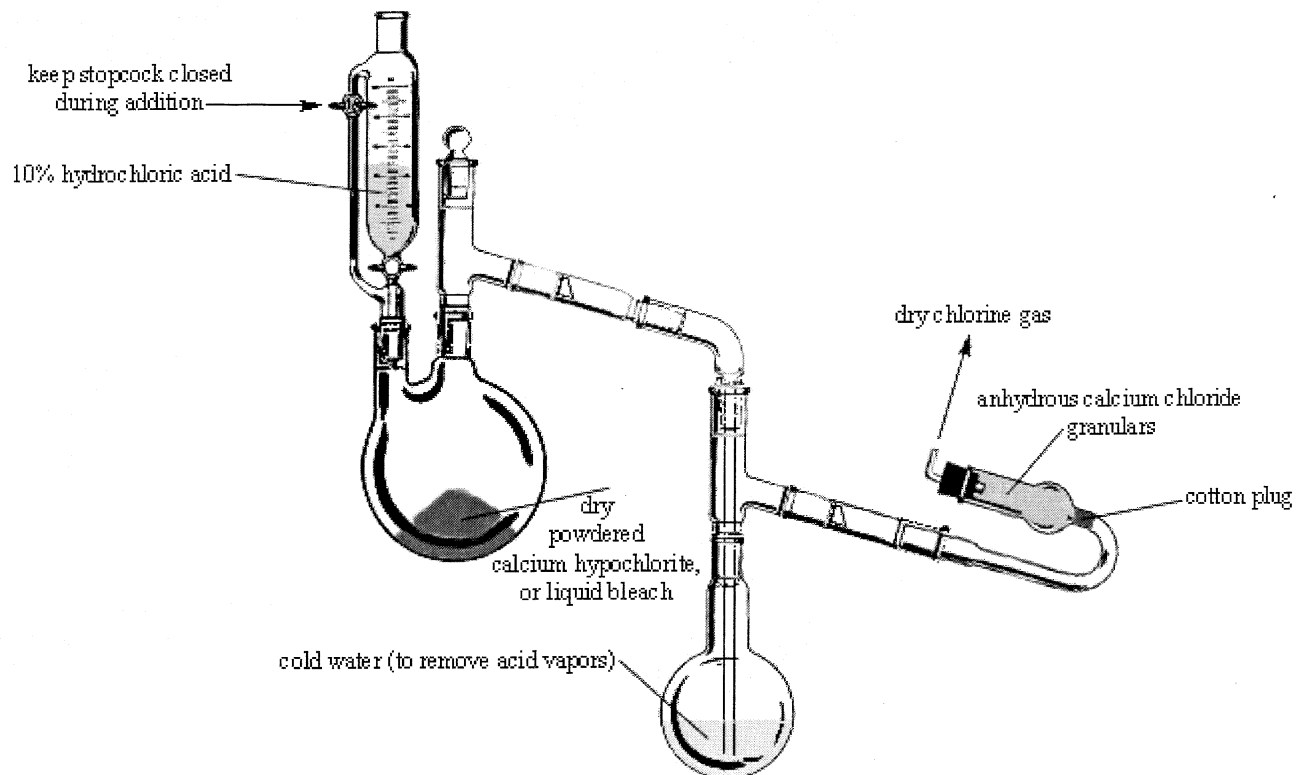


Figure 022. Apparatus for preparing chlorine gas (manganese dioxide can be used instead of calcium hypochlorite).

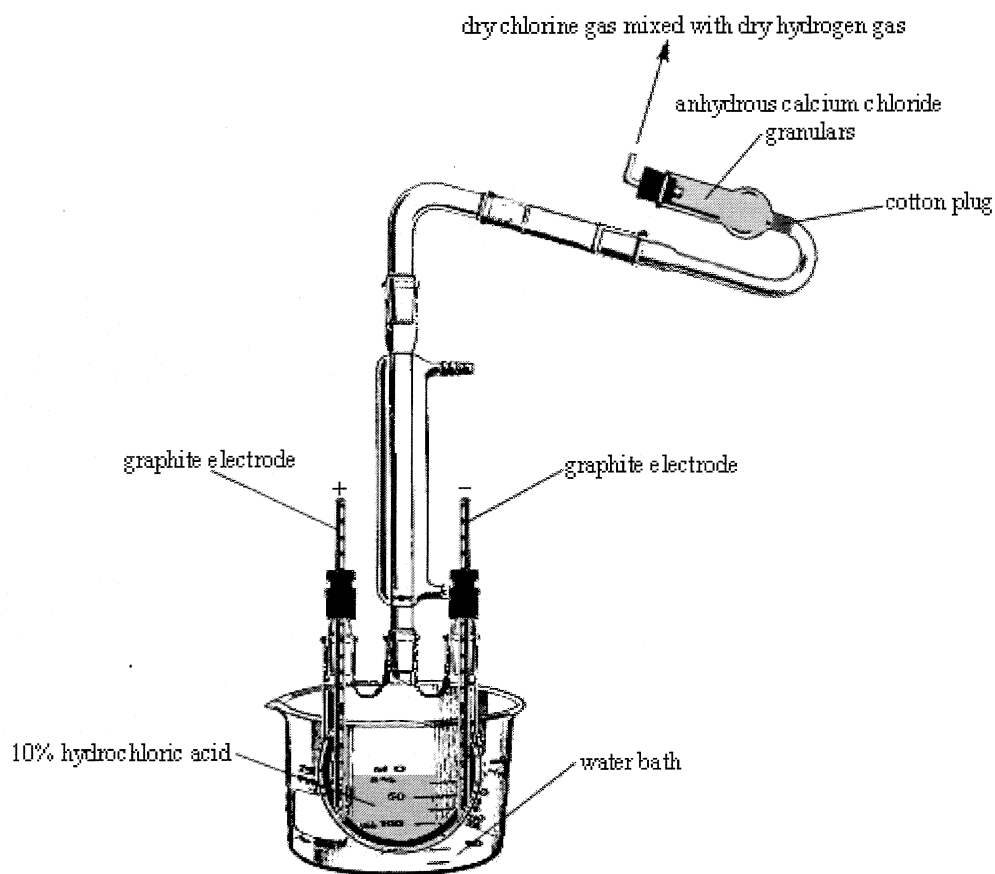
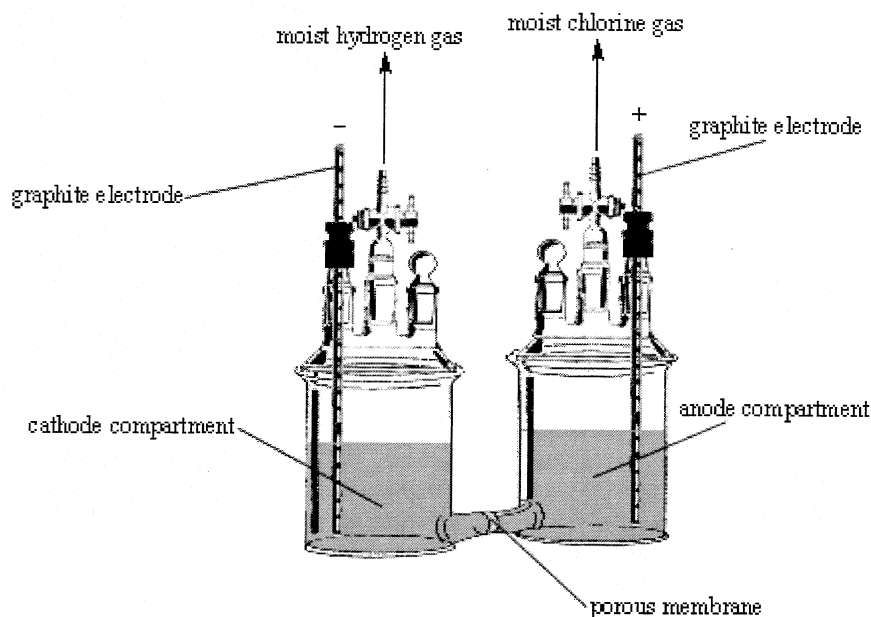
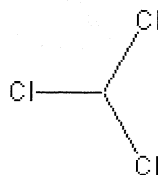


Figure 023. Apparatus for the electrolysis of hydrochloric acid.



**Figure 024. Diaphragm cell for the production of chlorine. The moist chlorine can be easily dried using a calcium chloride drying tube, and afterwards, will be in high purity.**

### **Chloroform. Trichlormethane**



**Chloroform**

Chloroform is a highly refractive, nonflammable, heavy, very volatile, and sweet-tasting liquid with a peculiar odor. It has a boiling point of 62 Celsius, and a melting point of -64 Celsius. Chloroform forms a constant boiling mixture with alcohol containing 7% alcohol, and boiling at 59 Celsius. Commercial chloroform contains a very small amount of ethanol as stabilizer. It is insoluble in water, but miscible with alcohol, benzene, ether, petroleum ether, and carbon disulfide. Pure chloroform is light sensitive, so store in amber glass bottles in cool place. Chloroform is a suspected light carcinogen, so use proper ventilation when handling. Over exposure to chloroform vapors causes dizziness, and headache. **Note:** Distilling mixtures containing chloroform mixed with one or more strong base (lithium, sodium, or potassium hydroxide) can result in explosion. Always neutralize any base, or extract the chloroform before distilling.

### **Method of preparing chloroform**

**Summary:** Chloroform is prepared by reacting acetone with calcium hypochlorite, and then extracting the mixture with toluene. After extraction, the toluene/chloroform mixture is then double distilled to collect the chloroform in the receiver flask. After collecting the chloroform, it is mixed with a small amount of 95% ethanol to act as a stabilizing agent.

**Hazards:** Extinguish all flames before using acetone, which is highly volatile and flammable. Calcium hypochlorite is a powerful oxidizer, and should never be mixed with concentrated sulfuric acid—explosions will result. Chloroform inhalation should be avoided, but is not threatening in mild condition.

**Procedure:** Place 100 grams of water and 100 grams of acetone into a beaker, and then cool to 0 Celsius while stirring. Then slowly add in small portions, 1181 grams of 65 to 70% calcium hypochlorite (commercially available; sold under a variety of brand names for use in swimming pools and hot tubs) over a period of 1 hour while stirring the acetone solution and maintaining its temperature at 0 Celsius. After the addition of the 65 to 70% calcium hypochlorite, continue to stir the reaction mixture at 0 Celsius for an additional thirty minutes. Afterwards, stop stirring and then extract the reaction mixture with four 100-milliliter portions of toluene. After

extraction, combine all four portions (if not already done so), and then place the combined portions into a distillation apparatus and then distill at 65 Celsius until no more chloroform passes into the receiver flask. When no more chloroform passes into the receiver flask, stop the distillation, and then remove the receiver flask from the distillation apparatus. Then add 20 grams of anhydrous calcium chloride to the receiver flask, and then swirl the flask for ten minutes. After which, filter-off the calcium chloride and then pour the filtered chloroform into a clean distillation apparatus and distill at 62 Celsius until no more chloroform passes into the receiver flask. When no more chloroform passes into the receiver flask, stop the distillation, and then remove the chloroform from the receiver flask and then add 1 milliliter of 95% ethanol to the chloroform. Then store the chloroform in an amber glass bottle.

### Alternative method for preparing chloroform

**Summary:** Chloroform can be made by electrolyzing a solution of sodium chloride, magnesium sulfate heptahydrate, isopropyl alcohol, and potassium dichromate for an extended period of time using graphite electrodes. After the electrolysis process, the resulting mixture is extracted with toluene and the extracted portions combined and distilled to yield chloroform.

**Procedure:** Place 297 grams of sodium chloride (table salt), 30 grams of magnesium sulfate heptahydrate (Epsom salt), and 1.5 grams of potassium dichromate into a 1500-milliliter 3-neck flask, and then add 1000 milliliters of water. After adding the water, stir the mixture to dissolve all solids. When all solids are dissolved add 100 grams of 99% isopropyl alcohol (Note: 99% isopropyl alcohol can be obtained by salting out 70% isopropyl alcohol, which is sold under the name "rubbing alcohol", with excess sodium chloride. Then decanting the upper isopropyl alcohol layer. After adding the isopropyl alcohol, rapidly stir the mixture at room temperature for five minutes. After which, insert two graphite electrodes and electrolyze the mixture at about 6 amp 12 volt for about 10 hours. During the electrolysis, keep the 3-neck flask in a water bath and continuously stir the reaction mixture. After about 10 hours, stop the electrolysis and then filter the reaction mixture. Afterwards, extract the filtered reaction mixture with four 100-milliliter portions of toluene. After extraction, combine all four portions (if not already done so), and then place the combined portions into a distillation apparatus, and then distill at 65 Celsius until no more chloroform passes into the receiver flask. When no more chloroform passes into the receiver flask, stop the distillation, and then remove the receiver flask from the distillation apparatus. Then add 20 grams of anhydrous calcium chloride to the receiver flask, and then swirl the flask for ten minutes. After which, filter-off the calcium chloride, and then pour the filtered chloroform into a clean distillation apparatus and distill at 62 Celsius until no more chloroform passes into the receiver flask. When no more chloroform passes into the receiver flask, stop the distillation, and then remove the chloroform from the receiver flask and then add 1 milliliter of 95% ethanol to the chloroform. Then store the chloroform in an amber glass bottle.

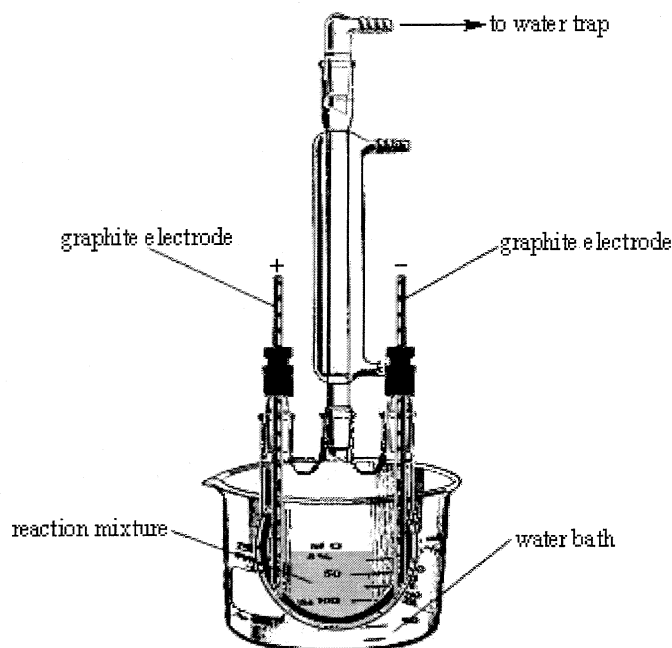
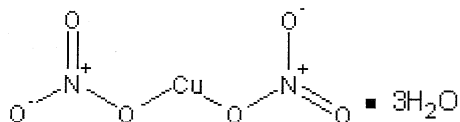


Figure 025. Apparatus for the electrolysis of salt and isopropyl alcohol in the preparation of chloroform

### Copper-II-nitrate trihydrate

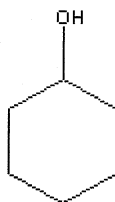
## Chapter 2: Reference guide



Copper nitrate

Copper-II-nitrate trihydrate forms bluish, deliquescent, rhombic crystal plates melting at 114 Celsius. It is freely soluble in water and alcohol. It is obtained by dissolving copper into dilute nitric acid, recrystallizing the hexahydrate from solution, followed by gently heating the hexahydrate at 30 Celsius for several hours.

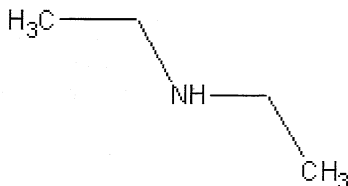
### Cyclohexanol



Cyclohexanol

Cyclohexanol forms hygroscopic crystals of camphor like odor with a melting point of 23 Celsius. It can be distilled by heating to 161 Celsius. Cyclohexanol is only slightly soluble in water, but it is miscible with ethanol, ethyl acetate, linseed oil, and aromatic solvents. Cyclohexanol is prepared by the hydrogenation of phenol with hydrogen in the presence of platinum. Cyclohexanol is highly flammable so extinguish all flames before using.

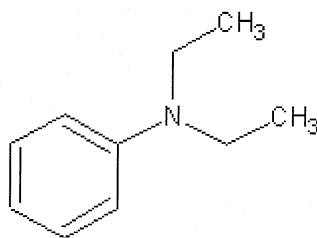
### Diethylamine



Diethylamine

Diethylamine forms a flammable highly alkaline colorless liquid with a melting point of -50 Celsius, and a boiling point of 55 Celsius. It is very soluble in water, and tends to form a hydrate. The liquid is a strong base, and it readily forms salts with strong acids. Diethylamine is usually sold as the hydrochloride, or as a concentrated water solution. It is prepared on an industrial scale by reacting ammonia with ethanol, followed by fractional distillation to separate the mono and triethylamines formed.

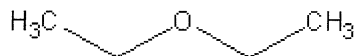
### Diethylaniline. *N,N*-diethylaniline



Diethylaniline

Diethylaniline forms a colorless to light yellow liquid with a boiling point of 215 Celsius. It has a melting point of  $-38$  Celsius, and is volatile with steam. It is slightly soluble in alcohol, chloroform, and ether. It can be prepared by reacting bromobenzene with sodium amide and diethylamine.

#### Diethyl ether. Ether



Diethyl ether

Diethyl Ether, other wise known as just ether, is a mobile, very volatile, highly flammable liquid, which produces explosive vapors. It has a sweetish, pungent odor, and a burning taste. Ether forms explosive peroxides when exposed to air—ether containing peroxides will detonate if heated, shattering the glass vessel. Before heating mixtures containing ether, the peroxide test should be conducted. To test for peroxides, add five drops of ferrous chloride solution to the ether mixture. If a red or black color appears, peroxides are present. *Note: This test will not work properly if there are oxidizing agents in the ether mixture.* Ether can be stabilized by the addition of small amounts of naphthols, but this does not protect ether 100% from peroxide formation. Ether has a melting point of  $-116$  Celsius, and a boiling point of 35 Celsius. Ether and air mixtures are explosive, so extinguish all flames and do not smoke when handling it. Protect ether from static electricity, which can also cause fire. Ether is insoluble in water, but miscible with alcohol, benzene, chloroform, and many oils. Do not mix 99% nitric acid with ether, as detonation will take place. Inhalation of ether vapors can produce intoxicating effects. These effects include feelings of euphoria, well-being, relaxation, and a general state of high. These effects can also lead to feelings of drunkenness, and hallucinations. Ether is a narcotic in high concentrations, but is not habit forming. Store ether in tightly sealed bottles in a cool place (preferably in a refrigerator). For prolonged storage, store ether over sodium sulfite and keep in a bottle filled to the top (to minimize the air space). Ether can be prepared by heating 95% ethanol and 98% sulfuric acid (1 to 1 ratio) to 100 Celsius, and simultaneously condensing the distilled-off vapors of ether. The ether is then purified by re-distillation. Ether is a widely available commercial chemical.

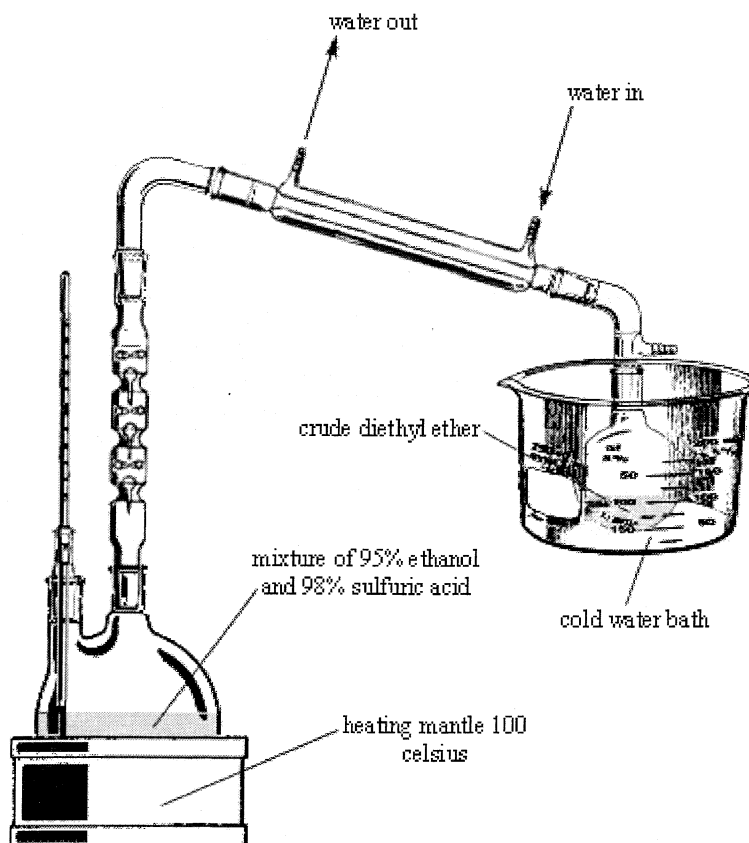
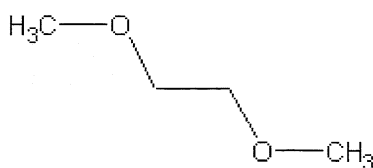


Figure 026. Apparatus for the preparation of diethyl ether. The ether should be re-distilled.

#### Dimethoxyethane. 1,2-Dimethoxyethane

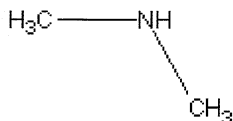




1,2-Dimethoxyethane

Dimethoxyethane forms a colorless liquid with sharp ether like odor. It has a melting point of  $-58$  Celsius, and a boiling point of  $82$  Celsius. It is miscible with water, alcohol, and is soluble in hydrocarbon solvents.

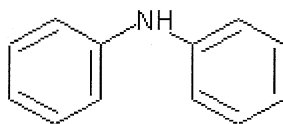
### Dimethylamine



Dimethylamine

Dimethylamine is a colorless gas with a characteristic odor. It has a melting point of  $-96$  Celsius, and a boiling point of  $7$  Celsius. The gas is very soluble in water, and its aqueous solution is very alkaline. Dimethylamine is usually sold as a gas compressed into cylinders over liquid, or as a 33% aqueous solution. The gas is very soluble in water, and it is appreciably soluble in alcohol and ether. Dimethylamine forms salts with strong acids. It is prepared by passing methanol and ammonia through a copper tube at  $200$  Celsius, followed by condensation of the resulting vapors, and fractional distillation.

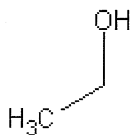
### Diphenylamine. *N*-Phenylbenzeneamine



Diphenylamine

Diphenylamine forms colorless to white crystals with a characteristic floral-like odor. It has a melting point of  $53$  Celsius, and a boiling point of  $302$  Celsius. It tends to decompose and discolors on exposure to light. Diphenylamine is insoluble in water and only slightly soluble in alcohol, but it is freely soluble in benzene, ether, glacial acetic acid, and carbon disulfide. It readily forms salts with strong acids. It is conveniently prepared in the lab by heating aniline with aniline hydrochloride in benzene, followed by evaporating-off the benzene.

### 95% Ethanol. *Ethyl alcohol*; *ABS alcohol*; *grain alcohol*



Ethanol

95% Ethanol is a clear, colorless, very mobile, flammable liquid with a pleasant odor, and a pungent, burning taste. It has a boiling point of  $78$  Celsius and a melting point of  $-114$  Celsius. 95% Ethanol slowly absorbs water from the air, and dilute ethanol solutions are slowly oxidized by air forming brown colored solutions containing mixtures of aldehydes, and carboxylic acids; mainly acetic acid. 95% Ethanol is miscible with water, and many organic solvents. 95% ethyl alcohol is called absolute ethanol because ethyl alcohol forms a binary azeotrope containing 95.57% ethyl alcohol by weight with a boiling point of  $78$  Celsius. Distillations cannot produce 99% ethanol because of this azeotrope. Ethyl alcohol is usually sold as denatured ethyl alcohol (mixed with small amounts of toxic chemicals to make non-drinkable) due to US government tax regulations. 95% Ethyl alcohol is toxic, and ingestion can cause

alcohol poisoning. Dilute mixtures of ethanol (Vodka, Gin, Rum, Jack Daniels, and wine) produce intoxicating effects when ingested (these intoxicating effects can be increased if the dilute ethanol mixture is injected). 95% ethanol can be made by fermenting starch or sugars with yeast, followed by double distillation. 95% Ethanol is manufactured on an industrial scale by the petroleum industry from ethylene gas, sulfuric acid, and water. 95% Ethanol is a widely available commercial chemical sold under a variety of names. 95% ethanol can be obtained from double distillation of alcoholic beverages such as vodka, gin, or rum.

### **Method of preparing 95% ethanol**

**Summary:** 95% ethanol can be prepared by double distilling cheap vodka. After the first distillation the distilled liquid is treated with baking soda to remove odors, filtered, and then the filtered liquid is redistilled producing 95% ethanol.

**Procedure:** Place 2 liters of cheap vodka (Popov, Kirov, Skol) into a distillation apparatus, and distill at 90 Celsius until no more liquid passes into the receiver flask. When no more liquid passes into the receiver flask, remove the heat source, and then remove the receiver flask from the distillation apparatus. Then place 100 grams of baking soda into the receiver flask, and swirl the flask for ten minutes. Afterwards, filter the liquid to remove the baking soda, and then place the filtered liquid into a clean distillation apparatus. Then distill at 80 Celsius until no more liquid passes into the receiver flask. See figure 027 for details on the appropriate distillation apparatus to be used.

### **Alternative method of preparing 95% Ethanol**

**Summary:** 95% Ethanol can also be obtained on a lower yield by hydrolyzing table sugar with dilute acid, and then fermenting the resulting mixture with yeast to form an ethanol solution. The solution will be contaminated heavily with by-products so multiple distillations and treatments with baking soda will be needed in order to fulfill proper purification. Baking soda is mixed with the distilled liquid to absorb odors and the like.

**Procedure:** Dissolve 1 kilogram of table sugar (sucrose) into 3 liters of water. Then rapidly stir this sugar mixture, and heat it to 80 Celsius. When the sugar solution reaches about 80 Celsius, continue stirring and add 5 drops of concentrated hydrochloric acid or 5 drops of concentrated sulfuric acid, and then continue heating and stirring for thirty minutes. After thirty minutes, remove the heat source, and allow the mixture to cool to room temperature. Then add 5 grams of baking soda to neutralize the acid. Afterwards, pour the sugar solution into an empty bottle (such as a clean empty plastic milk jug), and then add 5 to 10 grams of regular yeast (bakers yeast or preferably brewers yeast). Then stir the mixture for several minutes to insure good dispersion of the yeast. Then plug the bottles opening with cotton, and then place the bottle into a cool place away from light. Then allow the sugar mixture to ferment for about 4 weeks. After 4 weeks, remove the cotton from the bottles opening, and then pour the contents of the bottle into a distillation apparatus. Then distill at 100 Celsius for 4 ½ hours. After which, remove the heat source, and then remove the receiving flask from the distillation apparatus. Then add 100 grams of baking soda to the contents in the receiving flask, and then swirl the flask for ten minutes. Afterwards, filter the mixture to remove the baking soda, and then place the filtered liquid into a clean distillation apparatus and distill at 80 Celsius until no more liquid passes into the receiver flask. When no more liquid passes into the receiver flask, remove the heat source, and then remove the receiver flask from the distillation apparatus. Then add 100 grams of baking soda to the receiver flask and then swirl the flask for ten minutes. After ten minutes, filter the mixture to remove the baking soda, and then place the filtered mixture into a clean distillation apparatus and distill at 78 Celsius until no more liquid passes into the receiver flask. See figure 027 for details on the appropriate distillation apparatus to be used.

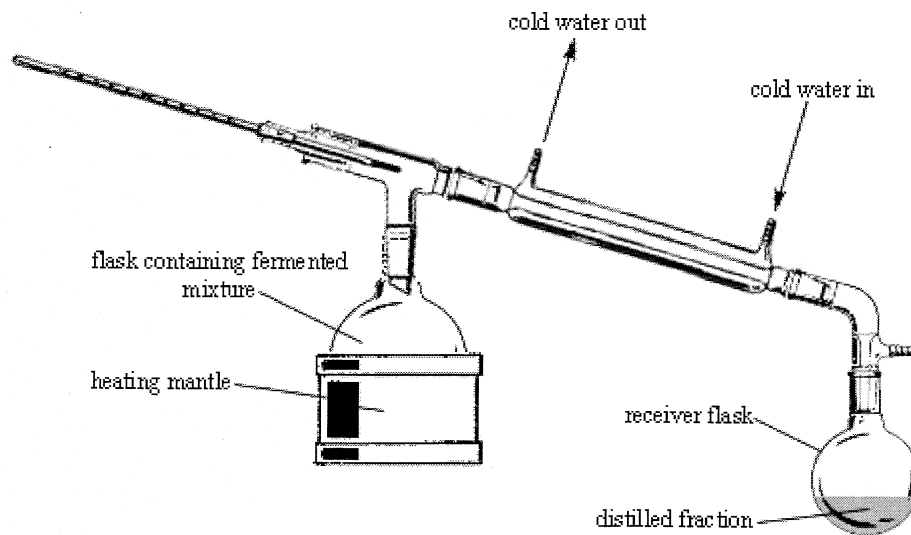
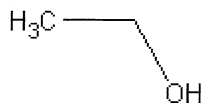


Figure 027. Apparatus for distillation of ethanol.

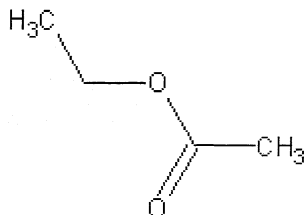
### 99% Ethanol



Ethyl alcohol

99% Ethyl alcohol is a colorless, very mobile and flammable liquid with a pleasant odor. Pure ethanol is tasteless. It rapidly absorbs water from the air, from which it forms an azeotrope of 95% ethyl alcohol. It is miscible with water, alcohol, ether, and many common organic solvents. 99% ethanol is toxic, and ingestion can cause poisoning. It is prepared by reacting ethylene gas with sulfuric acid, followed by distillation in the presence of minute amounts of water. It can also be made by double distillation of fermented cocktails, followed by treatment with metallic sodium to remove the water of azeotrope.

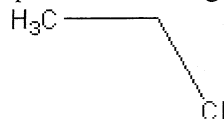
### Ethyl acetate



Ethyl acetate

Ethyl acetate is a clear, volatile, and flammable liquid with a pleasant, fruity odor. It has a pleasant taste when diluted. Ethyl acetate slowly decomposes by moisture. It has a boiling point of 77 Celsius, and a melting point of -83 Celsius. Ethyl acetate is moderately soluble in water (1 milliliter in 10 milliliters of water), but is miscible with alcohol, acetone, chloroform, and ether. It forms an azeotropic mixture with water (6% by weight with a boiling point of 70 Celsius). Ethyl acetate can be prepared by distilling a mixture of ethanol and acetic acid in the presence of a few drops of 98% sulfuric acid. Ethyl acetate is a widely available commercial chemical.

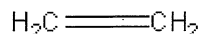
### Ethyl chloride



Ethyl chloride

Ethyl chloride is a flammable gas at room temperature, but it is easily compressed into a colorless liquid under mild pressure. It has a melting point of  $-138$  Celsius, and a boiling point of  $12$  Celsius. It has a characteristic ethereal like odor, with a burning taste. It is miscible with ether, and insoluble in water. It burns with a smoky greenish flame producing hydrogen chloride vapors. Ethyl chloride produces very cold temperatures upon evaporation, and hence, it's used in aerosol cans for treatment of sprains and bruises. It can be made in the lab by distilling a mixture of ethanol and concentrated hydrochloric acid in the presence of zinc chloride followed by condensation of the vapors with a cold trap.

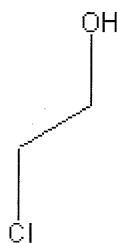
### Ethylene



Ethylene

Ethylene is a colorless flammable gas with a characteristic sweat odor. It burns with a luminous flame, and forms explosive mixtures with air. The gas solidifies at  $-181$  Celsius forming monoclinic prisms. It has a melting point of  $-169$  Celsius, and a boiling point of  $-102$  Celsius. The gas is soluble in acetone and benzene, but insoluble in water and only very slightly soluble in alcohol and ether. Ethylene gas is produced by ripening fruit, and it's produced on an industrial scale from hydrocarbons. Much of the ethylene produced by petroleum refineries is burned off, as it is a major by-product. It can be produced in the lab by slowly adding ethanol to concentrated sulfuric acid heated to  $180$  Celsius.

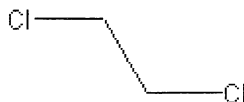
### Ethylene chlorohydrin



Ethylene chlorohydrin

Ethylene chlorohydrin forms a colorless liquid with a characteristic and irritating odor. It has a boiling point of  $130$  Celsius, but is easily distilled under vacuum. Its melting point is  $-67$  Celsius. Ethylene chlorohydrin is toxic, and ingestion, inhalation, and skin absorption should be avoided. It can be made by the action of ethylene gas with sodium hypochlorite, but can be made using a diaphragm cell with ethanol and salt in the anode compartment with a small amount of sulfuric acid using a lead or graphite electrode.

### Ethylene dichloride

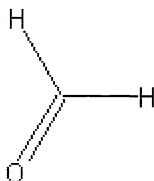


Ethylene dichloride

Ethylene dichloride is a heavy mobile liquid with a pleasant odor and sweet taste. It burns with a smoky flame and has a melting point of  $-40$  Celsius, and a boiling point of  $84$  Celsius. Ethylene dichloride is insoluble in water, but miscible with alcohol, chloroform, and ether. Ethylene dichloride is toxic so avoid skin contact and inhalation. It can be made by mixing ethylene gas with chlorine at room temperature, and then collecting the ethylene dichloride vapors by condensation. Ethylene dichloride can also be made by mixing acetylene gas with dry hydrogen chloride gas, and then collecting the vapors by condensation.

### Formaldehyde

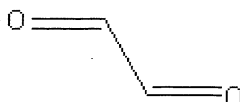
## Chapter 2: Reference guide



Formaldehyde

Pure formaldehyde is a colorless flammable gas with a pungent suffocating odor. The pure gas has a melting point of  $-92$  Celsius, and a boiling point of  $-19$  Celsius. In most cases, formaldehyde is handled as a 37% solution in water, from which methanol has been added to prevent polymerization. 37% formaldehyde solution is a colorless liquid with a pungent odor. Vapors from 37% formaldehyde can produce dizziness and headache upon inhalation, and maximum ventilation should be used when using. The colorless liquid solution may become cloudy on standing as a result of polymerization. 37% Formaldehyde slowly oxidizes to formic acid on standing. The liquid solution has a boiling point of 96 Celsius. It is miscible water, alcohol, and acetone.

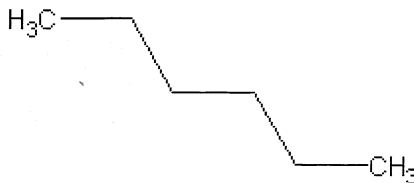
**Glyoxal.** *Ethanediol; Biformyl; Diformal*



Glyoxal

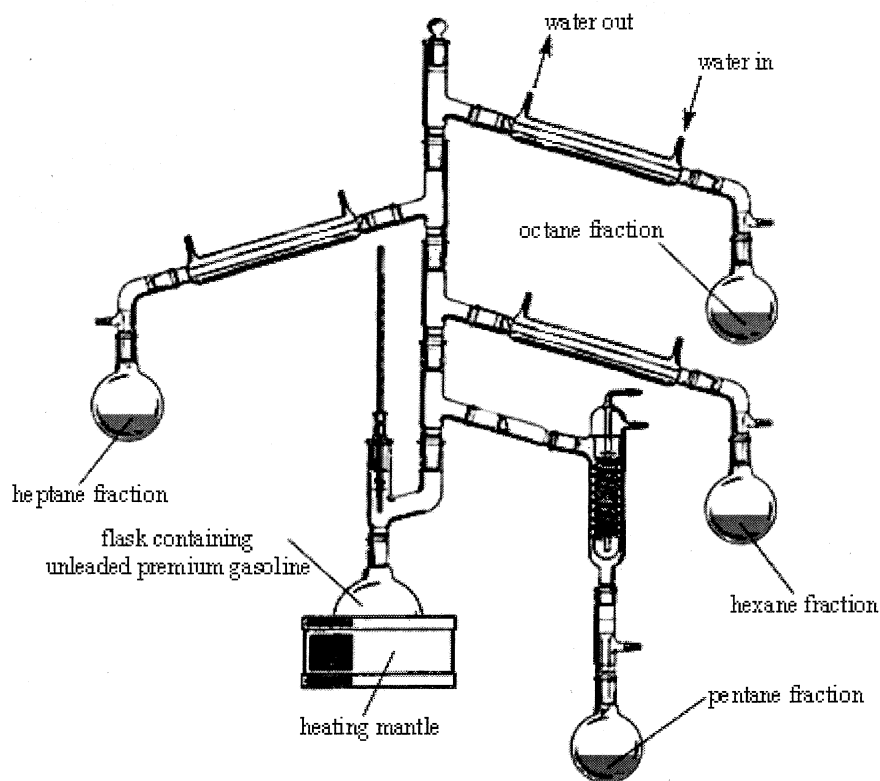
Glyoxal forms yellow prisms or irregular pieces, which turn white on cooling. Glyoxal has a melting point of 15 Celsius, and a boiling point of 51 Celsius (under pressure). It produces green vapors, which burn with a purple flame. Mixtures of glyoxal vapors with air may explode when ignited. Glyoxal is soluble in most organic solvents, and is usually sold as a 40% water solution. Pure glyoxal polymerizes rapidly and is unstable, but heating the dry polymer changes it back to glyoxal. Glyoxal is never sold as the dry solid because of decomposition problems. The 40% solution is commercially available.

**Hexanes.**



Hexane

Hexanes are a colorless, very volatile liquid with a faint, peculiar odor. It is rarely sold as n-hexane but usually admixed with hexane isomers simply called "hexanes". Hexane has a boiling point of 69 Celsius, and a melting point of  $-100$  Celsius. It is insoluble in water, but miscible with alcohol, chloroform, and ether. Hexane is a major component of gasoline, and can be distilled from the gasoline using a multiple-path distillation apparatus (see figure 028). Hexane is obtained commercially from petroleum, and is a widely available commercial chemical.



**Figure 028. Apparatus for the distillation of unleaded premium gasoline (carefully distill at 70 Celsius).**

**Hydrochloric acid.** 35 - 38% *Hydrochloric acid; Water solution of hydrogen chloride*



Hydrogen chloride

35 – 38% Hydrochloric acid is commonly referred to as concentrated hydrochloric acid. It is a highly corrosive liquid, which evolves choking and corrosive fumes. Some brands of concentrated hydrochloric acid may be colored yellow due to iron. Concentrated hydrochloric acid turns yellow when exposed to sunlight. It forms a constant boiling mixture with water containing 20% hydrogen chloride by weight, and boiling at 108 Celsius. Avoid contact with fumes, and keep in tightly sealed amber glass bottles. Concentrated hydrochloric is prepared on an industrial scale by condensing hydrogen chloride vapors, produced as a by-product in the production of chlorinated hydrocarbons. It can be prepared in the laboratory by mixing sodium chloride with 98% sulfuric acid and then passing the hydrogen chloride vapors into a quantitative amount of water. Concentrated hydrochloric acid is a widely available commercial chemical. It is available in most hardware stores sold under the name “Muriatic acid”.

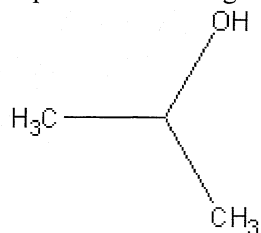
**Hydrofluoric acid**



Hydrofluoric acid

Hydrofluoric acid is a colorless highly fuming liquid, which is a 40 to 57% solution of hydrogen fluoride in water. The acid is miscible with water in all proportions. Hydrofluoric acid forms an azeotrope boiling at 112 Celsius. It is very toxic and inhalation of the fumes along with skin contact should be avoided at all cost. The acid attacks glass, porcelain, and stoneware, and should be kept in lead, or plastic containers. It is made by distilling a mixture of calcium fluoride with dilute sulfuric acid, followed by absorbing the vapors into water at low temperatures.

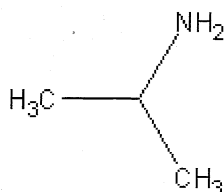
**Isopropyl alcohol**



Isopropyl alcohol

Isopropyl alcohol is a colorless flammable liquid with a characteristic acetone/ethanol odor. It has a melting point of  $-88$  Celsius, and a boiling point of  $82$  Celsius. Isopropyl alcohol is miscible in water, alcohol, ether, and chloroform. It is insoluble in salt solutions, and can be extracted from water solutions by the addition of excess salt. Isopropyl alcohol is very common, and is sold under the name "rubbing alcohol". It is manufactured on a large scale by reacting propylene gas with sulfuric acid followed by treatment with water, and subsequent distillation.

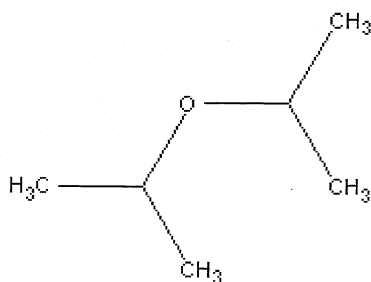
### Isopropylamine



Isopropylamine

Isopropylamine forms a colorless flammable liquid with ammonia like odor. It is a strong base, and readily forms salts with acids. It has a melting point of  $-101$  Celsius, and a boiling point  $33$  Celsius. It is miscible with water, alcohol, and ether. It is prepared in the lab by heating acetone with ammonia, followed by subsequent distillation of the vapors. The impure product, containing unreacted acetone, is then fractionally distilled to collect the pure isopropylamine.

### Isopropyl ether



Isopropyl ether

Isopropyl ether forms a colorless liquid with a characteristic ether-like odor and a boiling point of  $68$  Celsius. Isopropyl ether is highly flammable, and it forms dangerous peroxides on exposure to air. It should be stored in full containers with airtight lids, and it should be treated with ferrous sulfate or ferrous chloride prior to use to test for peroxides. Note: Treating ethers with ferrous sulfate or ferrous chloride will form the black ferric ion if peroxides are present. Isopropyl ether is insoluble in water, but miscible with most organic solvents. It can be made by distilling a mixture of isopropyl alcohol and concentrated sulfuric acid, followed by re-distillation.

### Magnesium

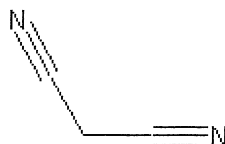
Mg

Magnesium

## Chapter 2: Reference guide

Magnesium is a silvery-white metal with a melting point of 651 Celsius, and a boiling point of 1100 Celsius. The metal is flammable, and burns with an intense light; even large bars are combustible but require much heat for ignition. Powdered magnesium burns violently and rapidly. The metal is insoluble in water, and only slowly reacts with water forming magnesium hydroxide. The metal readily reacts with dilute acids forming the corresponding salts, and it reacts with ammonium salt solutions forming double salts. The metal is capable of reducing many gases including carbon dioxide, sulfur dioxide, nitric oxide, and nitrous oxide when heated. Magnesium is readily available and can be purchased in many forms and sizes. It is prepared on an industrial scale by the electrolytic reduction of molten magnesium chloride.

### **Malononitrile.** *Propanedinitrile*



Malononitrile

Malononitrile is a colorless solid with a melting point of 32 Celsius. It can be distilled at 218 Celsius under normal pressure, or 109 Celsius at 20 millimeters of mercury. It is very soluble in alcohol, ether, and moderately soluble in water, acetone, and benzene.

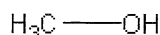
### **Mercury-II-chloride.** *Mercuric chloride*



Mercury-II-chloride

Mercury chloride forms white granules or powder with a melting point of 277 Celsius. The salt volatilizes at 300 Celsius but can volatilize at lower temperatures. Mercury chloride is a violent poison, and ingestion, inhalation, and skin absorption should be avoided at all costs. The salt is only slightly soluble in water, alcohol, acetic acid, glycerol, and ether. The salt is moderately soluble in methanol, acetone, and ethyl acetate. It can be prepared by refluxing concentrated hydrochloric acid with mercury-II-oxide.

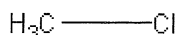
### **Methanol**



Methanol

Methanol is a flammable, poisonous, and mobile liquid. It has a slight alcoholic odor when pure, and burns with a non-luminous, bluish flame (flames from burning methanol cannot be seen on a clear sunny day). Methanol has a melting point of  $-97.8$  Celsius, and a boiling point of 65 Celsius. It is miscible with water, alcohol, ether, benzene, acetone, and most organic solvents. Methanol forms azeotropes with many solvents, and it dissolves many inorganic substances. Methanol is a toxic liquid, and ingestion leads to headache, vision problems, and death. The average fatal dose is usually 100 to 200 milliliters, but death has occurred from as little as 30 milliliters. Methanol can be prepared by destructive distillation of wood (heating wood to a high temperature in the absence of air), and then condensing the vapors. The condensed vapors are then distilled to separate the methanol from the acetic acid. Methanol is prepared industrial from carbon monoxide and carbon dioxide. Methanol is a widely available commercial chemical and is the chief ingredient in windshield wiper fluid; from which it can be separated by double distillation.

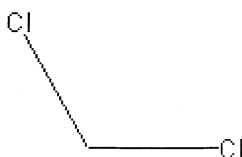
### **Methyl chloride**



Methyl chloride

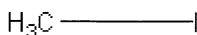
Methyl chloride is a colorless gas with an ethereal like odor and sweet taste. It has a melting point of  $-97$  Celsius, and a boiling point of  $-23$  Celsius. It is easily compressed into a liquid under pressure. Methyl chloride is flammable, and it is capable of forming explosive mixtures with air. The gas is toxic and inhalation should be avoided. It is miscible with chloroform, ether, glacial acetic acid, but it is only slightly soluble in water. Methyl chloride is produced on an industrial scale by the chlorination of methane with heat.



**Methylene chloride.** *Dichloromethane*

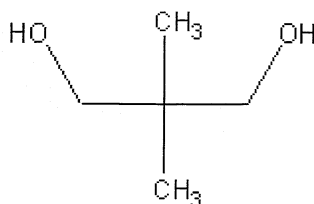
Methylene chloride

Methylene chloride is a colorless, highly volatile liquid, which is insoluble in water, but miscible with ether, and alcohol. It has a boiling point of 40 Celsius, and a melting point of -95 Celsius. Methylene chloride is a powerful, and widely used solvent that is readily available commercially. Methylene chloride is obtained by condensing the vapors obtained by the reaction of dry chlorine with dry methane. The methylene chloride is then separated from the chloroform and carbon tetrachloride by distillation.

**Methyl iodide**

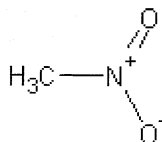
Methyl iodide

Methyl iodide forms a colorless very heavy, and highly refractive liquid, which darkens on exposure to light, air, and moisture. The liquid has a melting point of 6 Celsius, and a boiling point of 181 Celsius. Methyl iodide tends to solidify when cooled to 5 Celsius, from where it forms colorless leaflets. Methyl iodide can be prepared in the lab by heating iodoform with sodium acetate in the presence of alcohol.

**Neopentyl glycol**

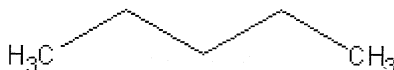
Neopentyl glycol

Neopentyl glycol forms colorless odorless needles, with a melting point of 127 Celsius, and a boiling point of 208 Celsius.

**Nitromethane**

Nitromethane

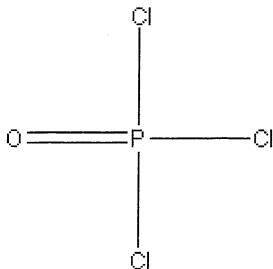
Nitromethane is an oily liquid with a strong odor. It is highly flammable, and has a melting point of -29 Celsius with a boiling point of 101 Celsius. Nitromethane is not very soluble in water, but is soluble in alcohol, ether, and DMF. It can form explosive salts with sodium, which ignite in contact with water. Nitromethane is used in liquid rocket fuels, and is produced on an industrial scale from vapor-phase oxidation of propane with nitric acid vapor. Nitromethane can be prepared on a laboratory scale by mixing sodium nitrite with sodium chloroacetate. Nitromethane is a widely available commercial chemical.

**Pentanes**

Chapter 2: Reference guide  
Pentanes

Pentanes are a highly flammable liquid with a melting point of  $-129$  Celsius, and a boiling point of  $36$  Celsius. Pentanes are insoluble in water, but soluble in many organic solvents. Pentanes can be obtained in a similar manner as for hexanes, see *vide supra*, and can be used in place of hexanes.

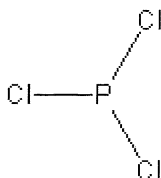
**Phosphorus oxychloride**



Phosphorus oxychloride

Phosphorus oxychloride forms a colorless to slightly colored highly fuming liquid with a boiling point of  $105$  Celsius. It has a melting point of  $1$  Celsius, and solidifies when cooled to  $0$  Celsius. The liquid has a strong and irritating odor, and inhalation and skin contact of the fumes should be avoided. It decomposes vigorously in the presence of water or alcohol. Phosphorus oxychloride is a strong chlorinating agent and is used to chlorinate organic compounds. It can be prepared by the oxidation of phosphorus trichloride.

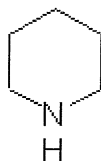
**Phosphorus trichloride**



Phosphorus trichloride

Phosphorus trichloride is a colorless highly fuming liquid with a melting point of  $-112$  Celsius, and a boiling point of  $76$  Celsius. It is rapidly decomposed by water or alcohol. Phosphorus trichloride is soluble in benzene, chloroform, ether, and carbon disulfide. Phosphorus trichloride is corrosive and irritating, and should be handled with care. It can be made by: 1) conversion of trisodium phosphate into calcium phosphate by reaction with calcium chloride in solution; 2) roasting the calcium phosphate with charcoal at  $1000$  Celsius; 3) suspending the resulting mass (containing calcium phosphide and charcoal) into methylene chloride or chloroform, and then bubbling in chlorine gas at room temperature; and 4) recovery of the phosphorus trichloride by filtration, followed by removal of the solvent.

**Piperidine. Hexahydropyridine**

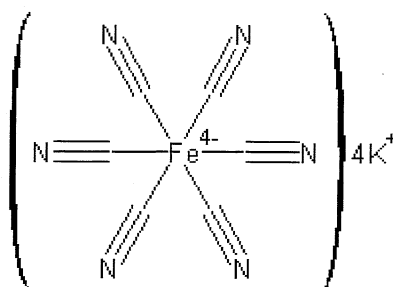


Piperidine

Piperidine forms a colorless liquid with a characteristic odor. It produces a soapy-like feel on the skin. It has a melting point of  $-7$  Celsius, and a boiling point of  $106$  Celsius. It tends to solidify at  $-13$  Celsius. Piperidine is a strong base, and it forms salts with strong acids. It is miscible with water, and moderately soluble in alcohol, benzene, and chloroform. The liquid is quite poisonous, and inhalation and skin contact of the vapors and liquid should be avoided. It can be prepared by heating piperine with alcoholic potassium hydroxide.

**Potassium cyanide****Potassium cyanide**

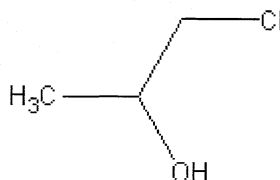
Potassium cyanide forms white deliquescent powder or granules, or fused pieces with a slight odor of hydrogen cyanide. Potassium cyanide is slowly decomposed by air and carbon dioxide on standing, and should be kept in tightly sealed bottles. Potassium cyanide is a deadly poison, and ingestion of as little as 50 milligrams may be fatal. The salt has a melting point of 634 Celsius, and it is moderately soluble in water, glycerol, and only very slightly soluble in alcohol. Aqueous solutions of potassium cyanide are strongly alkaline, and rapidly decompose on standing. Potassium cyanide should be kept away from acids, and strong oxidizers. Avoid ingestion and skin absorption.

**Potassium ferrocyanide****Potassium ferrocyanide**

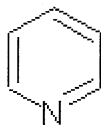
Potassium ferrocyanide exists as a trihydrate from which it forms brilliant soft crystals, which efflorescent on standing. The trihydrate begins to lose water when heated to 60 Celsius, and it becomes anhydrous at 100 Celsius. Potassium ferrocyanide is considered non-toxic, and is an excellent source of hydrogen cyanide when treated with acids. The salt is readily available from a number of sources including on-line auction sites, photography supply stores, and chemical suppliers.

**Potassium hydroxide****Potassium hydroxide**

Potassium hydroxide forms white or slightly yellow lumps, rods, or pellets, which rapidly absorb moisture and carbon dioxide from the air. It has a melting point of 360 Celsius. Pure potassium hydroxide has a melting point of 380 Celsius. It is very soluble in water, alcohol, and glycerol generating much heat when dissolved. Potassium hydroxide, and its solutions are very corrosive to the skin, and can produce burns. Keep dry potassium hydroxide or its solutions in tightly sealed bottles. Potassium hydroxide is toxic and ingestion causes tissue damage. It is prepared by the same manner as sodium hydroxide, and is a widely available commercial chemical.

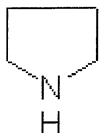
**Propylene chlorohydrin****Propylene chlorohydrin**

Propylene chlorohydrin forms a colorless liquid with a boiling point of 127 Celsius. It is very irritating to the eyes, nose and throat, and inhalation therefore should be avoided. It is soluble in water, alcohol, and other organic solvents. It can be made by reacting propylene gas with sodium hypochlorite, or it can be made in a similar manner as ethylene chlorohydrin using a diaphragm cell.

**Pyridine**

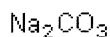
Pyridine

Pyridine is colorless, flammable liquid with a characteristic disagreeable odor. It has a melting point of  $-41$  Celsius, and a boiling point of  $115$  Celsius. Pyridine forms an azeotropic mixture with water boiling at  $92$  Celsius. It is miscible with water, alcohol, ether, oils, and many other common organic solvents. Pyridine is a weak base, but it forms salts with strong acids; it is commonly used to remove hydrogen chloride from reaction mixtures.

**Pyrrolidine**

Pyrrolidine

Pyrrolidine forms a colorless to slightly colored liquid, with an un-pleasant ammonia-like odor. It tends to fume in moist air, and has a boiling point of  $88$  Celsius. As usual, it is a strong base, and forms salts with strong acids. Pyrrolidine is miscible with water, but only moderately soluble in alcohol, ether, and chloroform. It is prepared by the reduction of pyrrole.

**Sodium carbonate**

Sodium carbonate

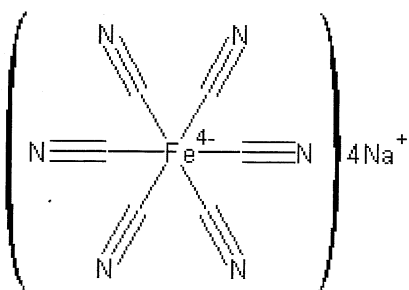
Anhydrous sodium carbonate is also called *Solway soda*, or *soda ash*. It is a odorless, hygroscopic powder with a melting point of  $851$  Celsius (begins to lose carbon dioxide when heated at  $400$  Celsius forming sodium oxide). Anhydrous sodium carbonate absorbs moisture from the air. It is soluble in glycerol and water, but insoluble in alcohol. It decomposes by acids with violent liberation of carbon dioxide. It combines with water evolving heat, and water solutions are strongly alkaline. The monohydrate forms odorless, small crystals or crystalline powder, which becomes anhydrous when heated at  $100$  Celsius. It is soluble in water and glycerol, but insoluble in alcohol. The decahydrate also called *Nevite*, or *washing soda*, forms transparent crystals, with a melting point of  $34$  Celsius. It is soluble in water and glycerol, but insoluble in alcohol. The decahydrate occurs in nature as the minerals *thermonatrite*, and *natron*. Anhydrous sodium carbonate is a widely available commercial chemical. It can be prepared by directly heating baking soda to  $400$  Celsius for one hour, or from scratch by bubbling carbon dioxide gas through a solution of sodium hydroxide, followed by filtration to remove the bicarbonate (baking soda), which is then roasted at  $400$  Celsius for one hour.

**Sodium cyanide**

Sodium cyanide

Sodium cyanide forms a colorless to white solid or fused granules. It is odorless, but develops a slight odor of hydrogen cyanide on standing. Sodium cyanide is a violent poison, and ingestion of as little as  $50$  milligrams may be fatal. Sodium cyanide has a melting point of  $563$  Celsius. It is freely soluble in water, but only slightly soluble in alcohol. The aqueous solution is strongly alkaline, and tends to decompose. Sodium cyanide solutions readily dissolve gold and silver forming complexes. Sodium cyanide is prepared on an industrial scale from the oxidation of methane with ammonia over a catalyst at  $1000$  Celsius, followed by absorption of the hydrogen cyanide into sodium hydroxide. Sodium cyanide is readily available, and can be purchased from many chemical suppliers. Avoid ingestion, and skin absorption.

**Sodium ferrocyanide**



Sodium ferrocyanide

Sodium ferrocyanide exists as the decahydrate from which it forms pale yellow crystals of monoclinic nature. The salt becomes anhydrous at 81 Celsius, and decomposes when heated to 435 Celsius forming sodium cyanide, iron, carbon, and nitrogen. It is moderately soluble in water, and solutions should not be stored for prolonged periods of time, as hydrogen cyanide develops. It is practically insoluble in most organic solvents. Sodium cyanide is a cheap substitute for potassium ferrocyanide, and can be used as a convenient source of hydrogen cyanide. Sodium ferrocyanide is considered non-toxic.

### Sodium fluoride



Sodium fluoride

Sodium fluoride forms tetragonal or cubic white or colorless crystals with a melting point of 993 Celsius. Sodium fluoride is soluble in water, but insoluble in alcohol, and many organic solvents. The aqueous solution etches glass, and hence should not be stored for prolonged periods of time in glass containers. The dry solid can be stored in glass bottles. Sodium fluoride is available in many household pesticides formulations, and can be made by neutralizing sodium hydroxide with hydrofluoric acid.

### Sodium hydroxide



Sodium hydroxide

Sodium hydroxide forms fused solid pieces, granules, rods, or powder. It rapidly absorbs moisture and carbon dioxide from the air. Solutions of sodium hydroxide are very corrosive to animal tissue, and aluminum. It has a melting point of 318 Celsius. Sodium hydroxide is very soluble in water and alcohol. It generates large amounts of heat when dissolving in water, or when mixed with acid. Sodium hydroxide is toxic. Handle sodium hydroxide with care. Sodium hydroxide is a widely available commercial chemical, which is sold under a variety of names such as "Lye". Sodium hydroxide is prepared on an industrial scale in a procedure called the "chloro-alkali" process. In the chloro-alkali process, a sodium chloride solution is electrolyzed in a special cell composed of two compartments separated by a porous membrane. Chlorine gas is produced at the positive anode, and sodium hydroxide forms at cathode.

### Process for the preparation of sodium hydroxide

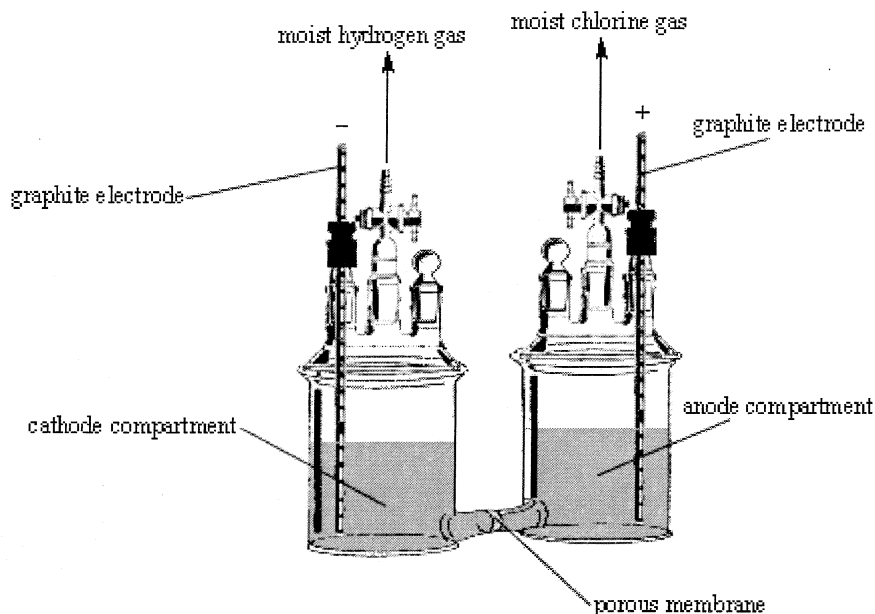
**Summary:** Sodium hydroxide can be prepared by electrolyzing a sodium chloride solution in a two-compartment cell separated by a porous membrane. Chlorine gas is liberated at the positive anode and hydrogen and sodium hydroxide are liberated at the cathode. *Use proper ventilation when running the electrolysis cell because of chlorine and hydrogen gas evolution. Run the cell in an area that is away from direct sunlight.*

**Hazards:** Chlorine gas is produced in this procedure; either properly vent the gas, or neutralize it by bubbling it through a sodium hydroxide or sodium carbonate solution. Carryout this procedure away from direct sun-light, and keep any source of ignition away—hydrogen gas is very flammable and explosive.

**Procedure:** Prepare a cell shown in figure 029, and then add 500 grams of table salt (sodium chloride preferable sold under the name "pickling salt") to a beaker and then add 1500 milliliters of water. Then stir the mixture to dissolve the table salt. After which, pour 1000 milliliters of water into the apparatus cathode compartment. Then pour about 100 milliliters of the sodium chloride solution into

## Chapter 2: Reference guide

the cathode compartment to bring its total volume to about 1100 milliliters. Afterwards, pour the rest of the sodium chloride solution into the apparatus anode compartment. Then put the graphite electrodes in place and electrolysis at 12-amp/12-volt until no more chlorine gas is evolved. When no more chlorine is evolved, stop the electrolysis. Then pour the cathode liquid into a beaker, and then filter to remove any insoluble materials. After filtering, pour the sodium hydroxide solution into a clean stainless steel beaker and then boil-off the water until dry sodium hydroxide solid remains. Do not use glass when boiling-off the water because the sodium hydroxide will corrode the glass and cause it to break.



**Figure 029. Apparatus for the production of sodium hydroxide. Chlorine gas is liberated at the positive anode electrode, and hydrogen gas is liberated at the negative cathode electrode. The sodium hydroxide is formed at the negative cathode electrode and remains dissolved in water.**

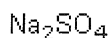
### Sodium hypochlorite solution



#### Sodium hypochlorite

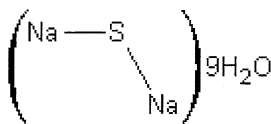
Sodium hypochlorite, commonly called bleach, is a light yellowish liquid with a characteristic chlorine-like odor. It is a powerful oxidizing agent, and is used extensively in disinfections and decontamination procedures. It is quite stable at room temperature, but decomposes when heated forming sodium chlorate and salt. It can be easily prepared using a diaphragm cell, or by passing chlorine gas into a 20% sodium hydroxide solution.

### Sodium sulfate



#### Sodium sulfate

Sodium sulfate occurs in nature as the minerals *mirabilite*, and *thenardite*. The anhydrous salt is called salt cake, and it forms a white powder or orthorhombic bipyramidal crystals. It has a melting point of 800 Celsius, and is moderately soluble in water. Sodium sulfate is insoluble in alcohol. The decahydrate is called glauber's salt, and it forms odorless, efflorescent crystals or granules, with a melting point of 32 Celsius. It becomes anhydrous when heated at 100 Celsius for 1 hour. It is soluble in water, and glycerol, but insoluble in alcohol. Sodium sulfate is a common salt of sulfuric acid, and can be made by reacting a water solution of Epsom salt with a water solution of sodium hydroxide or carbonate, and then filtering-off the precipitated by-product followed by recrystallizing the sodium sulfate from the water. The Sodium sulfate crystals are then heated to 100 Celsius for 1 to 2 hours to form the anhydrous salt. Sodium sulfate can also be made by neutralizing a dilute sulfuric acid solution with sodium hydroxide or carbonate, and then recrystallizing the sodium sulfate from the water. The sodium sulfate crystals are then heated to 100 Celsius for 1 to 2 hours to form the anhydrous salt. Sodium sulfate is a widely available commercial chemical.

**Sodium sulfide, hydrate**

Sodium sulfide nonohydrate

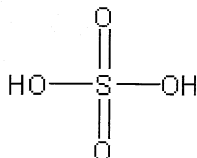
Sodium sulfide hydrate forms tetragonal deliquescent crystals with an odor of hydrogen sulfide. It discolors upon exposure to light and air, and has a melting point of  $-50$  Celsius. It becomes anhydrous when heated to  $120+$  Celsius. It is freely soluble in water, but only slightly soluble in alcohol. Sodium sulfide hydrate is insoluble in ether and other organic solvents. It decomposes by the action of acids forming the toxic gas hydrogen sulfide. Water solutions of the hydrate are slowly decomposed into sodium thiosulfate and sodium hydroxide; aqueous solutions should be kept for only short periods of time. Sodium sulfide hydrate should be kept in airtight amber glass bottles, as it slowly decomposes into hydrogen sulfide on standing. It can be prepared in the lab by roasting sodium sulfate with charcoal at  $1000$  Celsius, followed by precipitating the nonhydrate from water solution.

**Sulfur**

S

Sulfur

Sulfur forms a brilliant yellow solid with a melting point of  $94$  Celsius. It changes to the monoclinic form at  $94$  Celsius, which has a melting point of  $115$  Celsius. The monoclinic form changes back to the alpha form below  $94$  Celsius. Sulfur is insoluble in water, but soluble in carbon disulfide. It is only slightly soluble in benzene, acetone, and methylene iodide. It burns to sulfur dioxide when ignited, and combines with chlorine and bromine at room temperature. It combines with nearly all metals when both are in finely divided form, and heated. Sulfur is readily available commercially, and can be found in plant and garden stores.

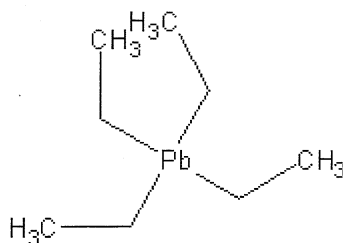
**98% Sulfuric acid**

Sulfuric acid

98% Sulfuric acid is a clear, colorless, odorless, oily liquid, which is very corrosive. 98% Sulfuric acid is referred to as concentrated sulfuric acid. Some grades of concentrated sulfuric acid may have a slight amber to brown tint due to ferrous sulfate impurity. Concentrated sulfuric acid has a great affinity for water; and hence, will char or dehydrate a great many substances. It chars wood, fabrics, resins, and also dehydrates sugar, forming carbon. Concentrated sulfuric acid has a boiling point of  $290$  Celsius. It decomposes when heated to  $340$  Celsius producing sulfur trioxide fumes and water. It has a melting point of  $10$  Celsius. Large amounts of heat are produced when concentrated sulfuric acid mixes with water or alcohol. When mixing with water, the acid should slowly be added. Never add the water to the concentrated acid. Concentrated sulfuric acid is a widely available commercial acid. It is the largest manufactured chemical in the world. Concentrated sulfuric acid is prepared on an industrial scale from sulfur dioxide by oxidation of sulfur or sulfides. Afterwards, the sulfur dioxide is converted into sulfur trioxide by oxidation with air over a platinum or vanadium pentoxide catalyst at  $500$  Celsius. The sulfur trioxide is then absorbed into 98% sulfuric acid forming 100% fuming sulfuric. This in turn is then treated with the calculated amount of water to form two parts of 98% sulfuric acid. The first part is then recycled for further absorption, and the second part is bottled and shipped. *Wear gloves when handling concentrated sulfuric acid.*

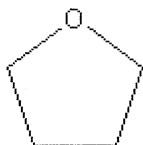
*Concentrated sulfuric acid is a very corrosive and toxic liquid. It can cause severe skin burns and irritation. Wear proper protective clothing (certified lab coat) when handling sulfuric acid because acid spills on cloths can cause a "melting" effect of the fabric. Note: In one documented case a laboratory student working in the lab, spilled concentrated sulfuric acid onto her nylons causing the nylon fibers to "melt" to her skin. She had to be rushed to the emergency room where doctors had to surgically remove each nylon fiber.*

**Note:** recovering sulfuric acid from water solutions can be accomplished by heating the sulfuric acid/water solution to  $110$  Celsius, and heating until no more water is evolved. This produces 93 to 98% sulfuric acid, which is perfectly suitable for use as 98% sulfuric acid (to determine when no more water can be evolved, place a piece of glass over the heated mixture. If the glass fogs-up, water is still being evolved from the sulfuric acid). **Hazards:** monitor the heating process very closely. Thick walled laboratory glass vessels should be avoided. Watch for white fumes, and be aware of potential irritating vapors; some decomposition of the acid may result.

**Tetraethyl lead**

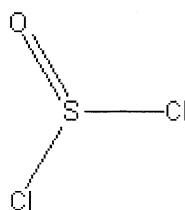
Tetraethyl lead

Tetraethyl lead forms a colorless liquid, which is flammable and burns with an orange colored flame. It has a boiling point of 200 Celsius, and decomposes when heated to 227 Celsius. The liquid is very poisonous, and ingestion may be fatal. Tetraethyl lead is insoluble in water, but soluble in benzene, petroleum ether, and gasoline. It is only slightly soluble in alcohol. It is made in the lab by refluxing a mixture of ethyl magnesium chloride in tetrahydrofuran with lead chloride. It was formerly used in gasoline as an anti-knock agent.

**Tetrahydrofuran.** *Diethylene oxide; Tetramethylene oxide*

Tetrahydrofuran

Tetrahydrofuran (THF) is a colorless liquid, with an ether-like odor. It has a melting point of  $-108$  Celsius, and a boiling point of 66 Celsius. It is miscible with water, alcohols, acetone, ethyl acetate, ether, and hydrocarbon solvents. Tetrahydrofuran slowly forms peroxides if stored in the presence of air. For storage, fill the bottle as full as possible (leaving as little air-gap as possible). Before distilling tetrahydrofuran or its mixtures, always add ferrous sulfate to check for, and destroy peroxides (a red or black color will appear). Explosions will result if peroxide contaminated tetrahydrofuran is distilled without treatment with ferrous sulfate, or other reducing agents. Tetrahydrofuran is a common solvent, and occurs in many commercial products. One source of tetrahydrofuran is PVC cement, which can be distilled to recover tetrahydrofuran. Tetrahydrofuran is a commercially available solvent.

**Thionyl chloride**

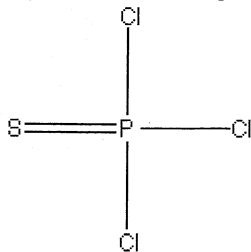
Thionyl chloride

Thionyl chloride forms a colorless to reddish fuming liquid with a melting point of  $-104$  Celsius, and a boiling point of 76 Celsius. It decomposes rapidly with water forming hydrogen chloride, and sulfur dioxide. Thionyl chloride decomposes into chlorine, sulfur dioxide, and sulfur monochloride when heated above 140 Celsius. It is miscible with benzene, chloroform, and carbon tetrachloride. Thionyl chloride is an irritating liquid, and inhalation and skin contact should be avoided. It can be made by reacting sulfur dichloride with sulfur trioxide, followed by distillation.

**Thiophosphorus trichloride**



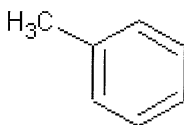
## Chapter 2: Reference guide



Thiophosphorus trichloride

Thiophosphorus trichloride forms a colorless to light yellow highly fuming liquid with a boiling point of 125 Celsius. It solidifies to the beta- form at -36 Celsius, and the alpha form at -40 Celsius. The liquid reacts with water forming hydrogen chloride and sulfuric acid. It should be stored in amber glass bottles in a cool place away from light. Thiophosphorus trichloride is soluble in benzene, chloroform, and carbon disulfide. It can be made by reacting phosphorus trichloride with phosphorus sulfide, or by interaction of phosphorus trichloride with aluminum chloride in the presence of sulfur.

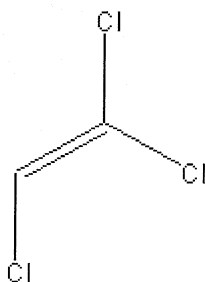
### Toluene



Toluene

Toluene is a flammable, refractive liquid with a benzene like odor. It has a melting point of -95 Celsius, and a boiling point of 110 Celsius. Toluene is insoluble in water, but miscible with alcohol, chloroform, ether, acetone, glacial acetic acid, and carbon disulfide. Toluene is toxic. It can be obtained from tar oil, and is a very common commercial solvent.

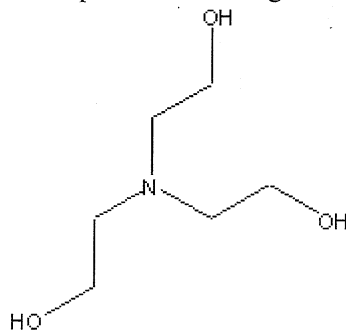
### Trichloroethylene



Trichloroethylene

Trichloroethylene is a non-flammable colorless liquid with a characteristic odor of chloroform. Its melting point is -84 Celsius, and its boiling point is 88 Celsius. It is insoluble in water, but miscible with ether, alcohol, and chloroform. Trichloroethylene should be stored in amber glass bottles in a cool place away from sunlight and moisture. It slowly deteriorates in the presence of light and moisture forming hydrogen chloride. Avoid inhalation of the vapors, and use maximum ventilation when handling. It is prepared on an industrial scale by boiling tetrachloroethane with lime.

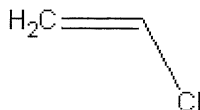
### Triethnaolamine



Triethanolamine

Triethanolamine is a viscous hygroscopic liquid with a slight odor of ammonia. It has a melting point of 21 Celsius, and a boiling point of 335 Celsius. It tends to decompose on standing on exposure to light and air forming a brownish substance. Triethanolamine is a strong base, and it readily forms salts with strong acids. It is miscible with water, methanol, and acetone. It is made by reacting ammonia gas with ethylene oxide gas at 100 Celsius, and then fractionally distilling to separate it from the mono and diethanolamines also formed.

### Vinyl chloride



Vinyl chloride

Vinyl chloride is a colorless gas with a melting point of  $-153$  Celsius, and a boiling point of  $-13$  Celsius. It can easily be liquefied using conventional cooling techniques. Vinyl chloride tends to polymerize in the presence of light or in the presence of a catalyst forming PVC. The gas is flammable, and forms explosive mixtures with air. The gas forms hydrogen chloride upon combustion. It is soluble in alcohol, ether, carbon tetrachloride, benzene, but only slightly soluble in water. It can be prepared in the lab by reacting ethylene dichloride with potassium in methanol, followed by condensation of the vapors.

### Zinc

Zn

Zinc

Zinc forms bluish-white lustrous hexagonal close-packed crystals, which are stable in air. Zinc has a melting point of 419 Celsius, and a boiling point of 908 Celsius. It becomes brittle when heated to 210 Celsius, from which it can be pulverized and ground. Finely divided zinc burns in the air forming a brilliant bluish-green flame. It is relatively stable, but reacts with acids and bases forming salts. It can be stored for years without any threat of tarnishing or discoloration, but it can be tarnished by moist air containing carbon dioxide, so it should be stored in airtight bags or containers, especially the powder or dust.

# Section II

## LACHRYMATOR, DISABLING, AND IRRITANT AGENTS

### Chapter 3: Physical Nature of Lachrymator, disabling, and irritant substances

#### Introduction

Riot control, disabling, and irritant substances are quite common in the field of law enforcement and civil authorities. They are used by the military for covert operations where disabling, confusing, and harassing the enemy is more important than killing. Common riot control agents include CS, chloroacetophenone, and bromobenzylcyanide. Common disabling agents are biphenyl arsenicals, bromoacetone, and chloropicrin, and irritant substances in general include BBC, chloroacetone, and dichloroacetone.

Most riot control agents are non-toxic, and their persistence is very low. The duration of action for most riot control agents is only 5 to 15 minutes on average, and their effects on the body are generally mild. Disabling agents such as adamsite are quite common vomiting agents, which are used by security personnel, bank vaults, and security sectors to disable intruders. Vomiting agents are virtually non-toxic, but the action upon the body can be very severe, producing nausea, vomiting, and general incapacitating results. Effects of vomiting agents upon the body can last hours, but produce no temporary illness. Irritant substances include a family of compounds called lachrymators. Lachrymators irritate the eyes, nose, throat, and skin resulting in itching, redness, rash, and general discomfort and pain. As with riot control agents, and disabling agents, lachrymators are considered non-toxic, but their effects upon the body can last for days.

Disabling and irritant substances are hardly ever used in riot control operations because of their general toxicity and severity of symptoms; although, some irritant substances are used as riot control agents, and may be classified as riot control agents rather than general irritants.

#### Physical properties of riot control, disabling, and irritant agents

Riot control agents are white to light colored solids, which have moderate to high melting points. Despite their high melting points, riot control agents are very volatile, and therefore easily disseminated through pyrotechnic munitions or other means. Most riot control agents are insoluble in water, but readily soluble in organic solvents such as alcohol, methylene chloride, ether, and benzene. Riot control agents like CS can be dissolved into water with the addition of propylene glycol for making irritant spray solutions.

Disabling agents are usually solids, with low to moderate melting points, but they may include colorless liquids, which may be volatile or non-volatile. The solids are not very soluble in water, but soluble in the usual organic solvents, but the liquids may be partially soluble in water, or only slightly soluble therein. Chloropicrin and bromoacetone are both very soluble in the usual organic solvents. Adamsite is a colorless to light colored solid, with a moderate melting point. It is not considered volatile under normal conditions, but can be generated into a smoke rather easily. Chloropicrin and bromopicrin are powerful disabling agents, which are colorless liquids. They are considered volatile under normal conditions, and can be disseminated using various techniques.

Irritating agents are colorless to light colored solids with low melting points, or colorless volatile liquids with high boiling points. Many irritating substances are either readily soluble in water, or partially soluble, and all are soluble in the usual organic solvents. Most irritating agents, which are solids, are very volatile and rapidly volatilize on standing. Liquid irritating agents tend to be quite volatile under normal conditions, and evaporate on standing under moderate rates.

#### Protection

Ordinary clothing gives adequate protection against riot control agents and disabling agents; although, some irritant agents can penetrate ordinary clothing leading to skin irritation. Some riot control agents like CS can stick to clothing, rendering a delayed irritant action. In most cases, ordinary respirators or gas masks protect against riot control, disabling, and irritant agents.

#### Decontamination

### Chapter 3: Physical Nature of Lachrymator, disabling, and irritant substances

Decontamination is not needed for riot control agents, disabling agents, or irritants under field conditions. Within enclosed environments, general decontamination of disabling or irritants may be needed, including aeration, bleach treatment, or caustic soda. Under field conditions, riot control, disabling, and irritants are readily swept away through the slightest breeze. Decontamination of exposed personal is not needed when riot control agents are used, and exposed personnel should be taken to fresh air. For disabling agents, there's little that can be done to decontaminate exposed personnel, and they should be taken to fresh air, and allowed to rest. Skin and eye exposure to irritating agents should be flushed with large amounts of warm water, with intermittent treatments with warm soapy water. In essence, there is no real method of decontaminating irritating agents under most conditions.

#### **Mechanism of body action**

Riot control and some irritating agents act upon the nerve endings, the cornea, and mucous membranes causing excessive fluid discharge, irritations, and general discomfort. The body detoxifies riot control and irritant agents quite readily, and the body recovers from any symptoms within minutes. Disabling agents act upon thio containing enzymes inhibiting them, and disrupting the pyruvate dehydrogenase system. The thio containing enzymes play a part in the energy production within the cells. Inhibition of these enzymes interferes with the respiration of the cell system, resulting in destruction of the cell structure. The result is a multitude of complex reactions that result in nausea, vomiting, muscle spasms, irritation, and a general sense of incapacitation.

#### **Signs and symptoms**

Exposure to riot control agents and irritant agents produces a multitude of symptoms including severe eye irritation, irritation to the nose and throat, skin irritation, skin redness, itching, rash, runny nose, profuse nasal discharge, soar throat, coughing, and severe bodily fluid discharge. Most symptoms are experienced within seconds of exposure, but only last for short periods of time. Ingestion, although far less common, leads to nausea and vomiting, with mild gastrointestinal disorders. Some irritants produce pronounced eye irritation followed by numbing or stinging pain, effects which can last hours or days, and some can even produce mild vestication. Inhalation of disabling agents produces severe burning and pain to the nose and throat, with excessive fluid buildup. Severe discomfort including nausea, vomiting, muscle tremors, and confusion usually follows within minutes of exposure. In some cases, symptoms may be delayed for up to 5 minutes, whereupon sneezing begins, and ends with headache and vomiting. Eye exposure to most disabling agents simply produces general irritation followed by itching, redness, and mild pain. In general, the eyes are relatively unaffected by the action of arsenical disabling agents, but bromoacetone and chloropicrin can produce severe eye irritation even under very low concentrations. Under high concentrations, arsenicals, and bromoacetone are capable of producing mild vesication, resulting in skin blisters; although, on the battlefield, high concentrations of these disabling agents is unlikely to be encountered

#### **Treatment**

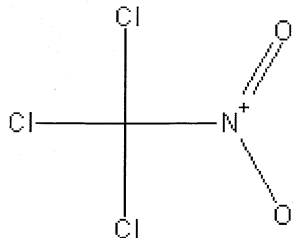
Treatment for riot control agents is limited to exposure. In most cases, exposure simply dissipates after several minutes. In most cases, exposed personnel should be taken to fresh air, and allowed to rest until the symptoms disappear. Warm water can be used to treat soar eyes, by simply flushing. The eyes should not be rubbed by fingers or coarse materials as infection may set in. For most cases, riot control agents are detoxified in the body within 30 minutes, so no real treatment is necessary.

Treatment of irritant agents is similar, but some may require general care. For exposed eyes, the eyes can be flushed with a dilute baking soda solution, followed by large amounts of warm water. The eyes should not be rubbed, so as to avoid infections. Irritated or itching skin can be treated by the effected area with warm soapy water, followed by applying a calamine lotion, phenol ointments, or aloe vera gel.

Disabling agents need not be treated under any severe medical conditions, and exposed personnel should be dealt with as severity of exposure dictates. Personnel exposed to low or mild concentrations should continue work and duties as active bodies detoxify the agents faster. Personnel exposed to high concentrations should be taken to fresh air, and allowed to rest.

# Chapter 4: Preparation of Lachrymator, disabling, and irritant substances

## 01-001. Chloropicrin. Nitrochloroform. Acquinite. Trichloronitromethane; Picfume



Chloropicrin

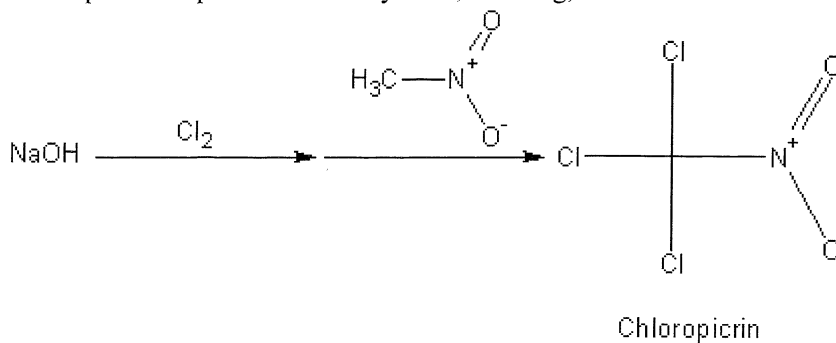
Chloropicrin forms an oily colorless liquid with an intense, stinging, and pungent odor. It has a melting point of  $-69$  Celsius, and a boiling point of  $112$  Celsius at  $757$  millimeters of mercury. Chloropicrin is insoluble in water, but readily soluble in most common organic solvents. It is very stable, and is not attacked by bleach. Solutions of strong alkalies only slowly decompose it, with increasing rates under higher temperatures. Chloropicrin can persist in the environment for long periods time ranging from weeks to months; although, due to volatility under certain conditions, it may only persist for several days. Chloropicrin can contaminate enclosed areas such bunkers, tunnel, and rooms for long periods of time. Chloropicrin is a strong irritant, and a potent riot control agent. Most agencies have banned chloropicrin for use in riot control due to its severe irritating nature. Inhalation of the vapor produces immediate and severe irritation to the nose, and throat. Chloropicrin is a potent skin irritant, and the vapor or liquid on the skin causes immediate and severe pain and irritation. It is not a vesicant, but prolonged skin exposure can lead to soars and spots, with permanent scars in some cases. Eye contact causes severe irritation as well, but irritation can be shortly delayed in some people. Eye exposure leads to severe pain and irritation; effects which can last for hours. Chloropicrin acts as an effective vomiting and choking agent. Inhalation of the vapor can cause fluid buildup, and a sense of congestion. Inhalation can also cause nausea and vomiting. Chloropicrin can be used in military operations where it is desired to confuse, irritate, and incapacitate enemy personnel, rather than kill or wound them. It can be used with outstanding results against rioters and/or protestors; dissemination would easily break up large crowds and leave the rioters and/or protestors running and screaming in pain and agony. Chloropicrin can be disseminated by aerosols, smoke generating munitions, explosives munitions, atomizers or humidifiers, or from fog making devices. The most effective method of dissemination is through aerosols. Chloropicrin can be decontaminated with a dilute solution of sodium bisulfite. **Chloropicrin is a fast acting riot control agent capable of producing irritation, confusion, and incapacitation to any exposed personnel within minutes of dissemination. Inhalation of as little as 5 milligrams can cause irritation and pain to the nose and throat. Eye contact to as little as 3 milligrams can cause irritation and pain. The lethal dose through inhalation ranges from 2000 to 2500 milligrams per person. Skin contact to as little as 10 milligrams can cause irritation and pain.**

OVERALL RATING (scale from 1 to 10)	
<i>Effectiveness (as disabling agent): 7</i>	<i>Field Stability: 9</i>
<i>Persistence (open area): 5</i>	<i>Storage stability: 10</i>
<i>Persistence (enclosed area): 9</i>	<i>Toxicity (as disabling agent): 8</i>
<b>TOTAL EFFECTIVENESS (as disabling agent): 8</b>	
<b>OVERALL TOXICITY (as warfare agent): 2</b>	

### Procedure 1-001A: Preparation of Chloropicrin

**Summary:** Chloropicrin is easily prepared by reacting a dilute solution of sodium hypochlorite (bleach) with a solution of nitromethane. In this process, the sodium hypochlorite is generated on sight by the addition of chlorine to a solution of sodium hydroxide. After the addition of the nitromethane solution, the desired chloropicrin separates as an oily liquid. This oily liquid can then be dried using anhydrous calcium chloride, and then stored until use. The chloropicrin can be distilled under very mild vacuum if desired. Note: The preparation of chloropicrin discussed in this procedure is similar or related to the process discussed in serial number 79,994, January 3<sup>rd</sup>, 1961 by John M. Wilhelm of Culver City CA. This process may be protected by industrial/commercial process applications. Consult said application number before using the mentioned process for commercial or industrial purposes.

Chapter 4: Preparation of Lachrymator, disabling, and irritant substances



Reaction Equation (by products omitted)

<b>Materials:</b>	1. 290 grams of sodium hydroxide	3. 79 grams of nitromethane
	2. 250 grams of chlorine gas	4. 20 grams of anhydrous calcium chloride

**Hazards:**



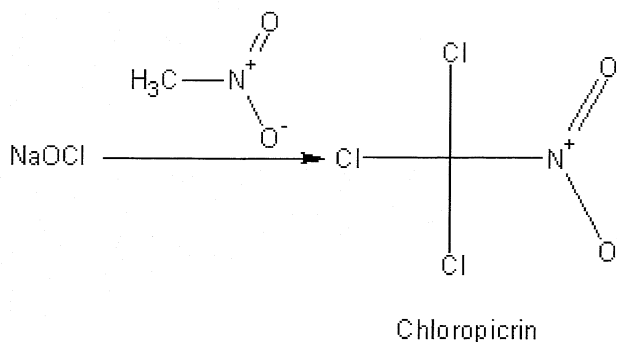
Do not attempt to prepare chloropicrin using the following procedure unless proper safety precautions are taken. 1) Perform all operations with good ventilation, maintain proper eye protection using eye wear that completely covers the eyes and forms a good seal on the face, and wear nitrile gloves. 2) After each procedure, all glassware and non-electric equipment should be soaked in a hot 5% sodium bisulfite solution before removing from the clean box, and/or before rinsing and storing. Any electrical equipment that may be contaminated (even if suspected), such as hot plates and stirring equipment should be carefully wiped down with a rag soaked in a hot 5% sodium bisulfite solution followed by wiping down with a rag soaked in hot water. 3) The desired chloropicrin product should be stored in amber bottles, preferably non-breakable containers, and stored in a cool dry place away from sunlight. The bottles should also be placed inside an airtight sealed plastic bag, such as a 'ziplock' bag. 4) Storage of any and all disabling agents should be in cabinets, drawers, or the like, and said storage spaces should be equipped with proper ventilation. Use care when handling nitromethane, which is highly flammable; extinguish all flames before using. Use care when handling chlorine gas, which is toxic, and very irritating. Sodium hydroxide can cause skin irritation, wear gloves when handling.

**Procedure:** Into a suitable flask place 1300 milliliters of water, and then add and dissolve 290 grams of sodium hydroxide. Note: much heat is evolved when sodium hydroxide is dissolved in water. After adding and dissolving the sodium hydroxide, allow the solution to cool to room temperature. Thereafter, bubble into this solution, 250 grams of chlorine gas over a period of about 4 hours while stirring the sodium hydroxide solution. After the addition of the chlorine, dilute the mixture by adding 1900 milliliters of water. Then prepare a nitromethane solution by adding 79 grams of nitromethane to 50 milliliters of water, and then add drop wise, this nitromethane solution to the sodium hydroxide/chlorine mixture. During the addition of the nitromethane solution, stir the sodium hydroxide/chlorine mixture and keep its temperature below 45 Celsius. After the addition of the nitromethane solution, stir the reaction mixture for about 1 hour, and then remove the lower chloropicrin layer using a separatory funnel. Then dry this chloropicrin layer by adding 15 grams of anhydrous calcium chloride, and then stir the mixture for several minutes. Then filter-off the calcium chloride, and place the filtered chloropicrin into a suitable glass amber bottle, and store in a cool dry place until use. Note: the chloropicrin can be distilled for quality and purity if desired, by placing it into a vacuum distillation apparatus, and vacuum distilling at 112 Celsius under a very mild vacuum of 757 millimeters of mercury. Note: Distillation of the chloropicrin is not needed for use in military operations.

**Procedure 1-001B: Preparation of Chloropicrin**

Chapter 4: Preparation of Lachrymator, disabling, and irritant substances

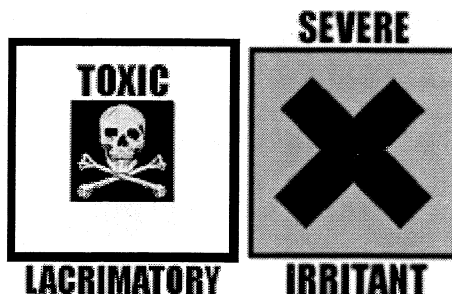
**Summary:** Chloropicrin is easily and readily prepared by reacting bleach (sodium hypochlorite) with nitromethane. After the reaction, the insoluble chloropicrin is simply removed using a separatory funnel. The chloropicrin is then dried with anhydrous calcium chloride.



*Reaction Equation (by products omitted)*

<b>Materials:</b>	1. 700 grams of 5% sodium hypochlorite (bleach)	3. 5 grams of anhydrous calcium chloride
	2. 25.7 grams of nitromethane	

**Hazards:**

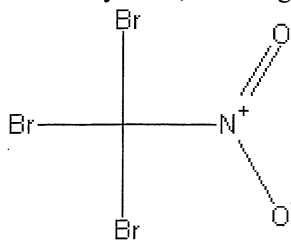


Do not attempt to prepare chloropicrin using the following procedure unless proper safety precautions are taken. 1) Perform all operations with good ventilation, maintain proper eye protection using eye wear that completely covers the eyes and forms a good seal on the face, and wear nitrile gloves. 2) After each procedure, all glassware and non-electric equipment should be soaked in a hot 5% sodium bisulfite solution before removing from the clean box, and/or before rinsing and storing. Any electrical equipment that may be contaminated (even if suspected), such as hot plates and stirring equipment should be carefully wiped down with a rag soaked in a hot 5% sodium bisulfite solution followed by wiping down with a rag soaked in hot water. 3) The desired chloropicrin product should be stored in amber bottles, preferably non-breakable containers, and stored in a cool dry place away from sunlight. The bottles should also be placed inside an airtight sealed plastic bag, such as a 'ziplock' bag. 4) Storage of any and all disabling agents should be in cabinets, drawers, or the like, and said storage spaces should be equipped with proper ventilation. Use care when handling nitromethane, which is highly flammable; extinguish all flames before using.

**Procedure:** Into a suitable flask, add 700 grams of a 5% sodium hypochlorite solution (ordinary bleach). Thereafter, prepare a nitromethane solution by adding 25.7 grams of nitromethane to 20 milliliters of water. Then gradually add the nitromethane solution to the bleach over a period of about 15 minutes while stirring the bleach. After the addition of the nitromethane solution, continue to stir the mixture for about 1 hour. Then place the reaction mixture into a separatory funnel, and remove the lower chloropicrin layer. Then dry this chloropicrin layer by adding 5 grams of anhydrous calcium chloride, and then stir the mixture for several minutes. Then filter-off the calcium chloride, and place the filtered chloropicrin into a suitable glass amber bottle, and store in a cool dry place until use. Note: the chloropicrin can be distilled for quality and purity if desired, by placing it into a vacuum distillation apparatus, and vacuum distilling at 112 Celsius under a very mild vacuum of 757 millimeters of mercury. Note: Distillation of the chloropicrin is not needed for use in military operations.

**01-002. Bromopicrin. Nitrobromoform. BromoAcquinite. Tribromonitromethane; Picfume bromide**

Chapter 4: Preparation of Lachrymator, disabling, and irritant substances



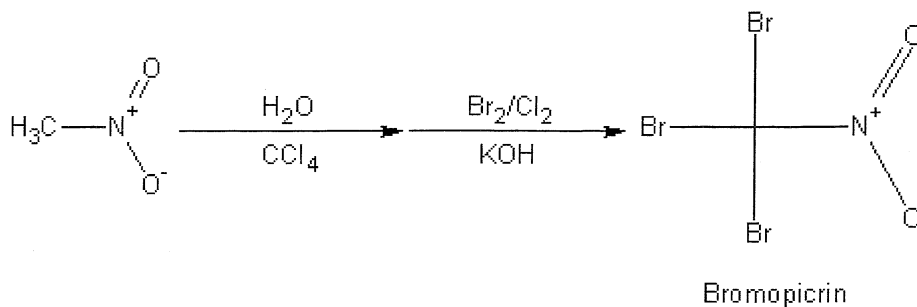
Bromopicrin

Bromopicrin forms colorless crystals, semi-liquid mass, or a colorless liquid with a strong, biting, and penetrating odor. It is very stable and is similar in nature to chloropicrin. Bromopicrin is a potent irritant, capable of causing severe eye, nose and throat irritation. Bromopicrin can be used as an effective chemical warfare agent where it is desired to irritate, confuse, and disable enemy troops. Exposure to the vapor produces immediate and severe distress and irritation. Eye contact produces severe pain, and in some cases severe fluid discharge making it almost impossible for exposed personnel to function on the battlefield. Inhalation can produce immediate and severe discomfort and pain to the nose and throat, leading to fluid buildup and a strong sense of congestion (like a severe cold or flu with added pain and irritation). Bromopicrin is a violent riot control agent, which has been banned by most agencies. It can be used as a vomiting and choking agent as well. Inhalation of the vapor can lead to nausea and vomiting. Skin contact to the vapor, liquid, or solid can result in severe skin irritation with soars or lesions forming within 8 hours of exposure. Bromopicrin can persist in the environment for prolonged periods of time, ranging from several days to several weeks due to its low volatility under normal conditions. Bromopicrin can be disseminated from aerosols, smoke generating munitions, and explosives munitions. Bromopicrin can also be dissolved into an inert solvent, and then disseminated as is. **Bromopicrin is similar to chloropicrin, and it's capable of causing casualties within minutes of dissemination. It is a violent irritant, capable of causing severe irritation of the eyes, nose, and throat. Eye contact to as little as 1 milligram can produce irritation. Inhalation of as little as 5 to 10 milligrams can cause nose and throat irritation immediately with congestion starting within minutes. The lethal dose through inhalation is as low as 1200 milligrams, but usually ranges from 1500 to 2200 milligrams per person. Skin contact to as little as 4 milligrams can produce irritation. Skin contact to as little as 10 to 25 milligrams can lead to formation of soars and or lesions.**

OVERALL RATING (scale from 1 to 10)	
<i>Effectiveness (as disabling agent): 8</i>	<i>Field Stability: 7</i>
<i>Persistence (open area): 6</i>	<i>Storage stability: 9</i>
<i>Persistence (enclosed area): 9</i>	<i>Toxicity (as disabling agent): 9</i>
<b>TOTAL EFFECTIVENESS (as disabling agent): 8</b>	
<b>OVERALL TOXICITY (as warfare agent): 2½</b>	

**Procedure 1-002A: Preparation of Bromopicrin**

**Summary:** Bromopicrin is readily prepared by reacting a mixture of nitromethane, water, and potassium hydroxide with a mixture of bromine and chlorine. The reaction takes place in a solvent of carbon tetrachloride, but this solvent can be replaced by chloroform if desired. After the reaction, the reaction mixture is evaporated to remove the solvent, and the remaining residue is then removed. This residue will contain a mixture of bromopicrin and chlorodibromopicrin. This mixture can be used directly in warfare operation if desired, or purified by fractional distillation under high vacuum. Note: The preparation of bromopicrin discussed in this procedure is similar or related to the process discussed in serial number 298,398, July 29<sup>th</sup>, 1963 by George A. Burk of Bay City Mich., and Ralph A. Davis of Midland Mich.; assigned by The Dow Chemical Company. This process may be protected by industrial/commercial process applications. Consult said application number before using the mentioned process for commercial or industrial purposes.



*Reaction Equation (by products omitted)*



<b>Materials:</b>	1. 160 grams of liquid bromine	4. 500 milliliter of carbon tetrachloride
	2. 116 grams of chlorine	5. 56 grams of potassium hydroxide
	3. 62 grams of nitromethane	

**Hazards:**

Do not attempt to prepare bromopicrin using the following procedure unless proper safety precautions are taken. 1) Perform all operations with good ventilation, maintain proper eye protection using eye wear that completely covers the eyes and forms a good seal on the face, and wear nitrile gloves. 2) After each procedure, all glassware and non-electric equipment should be soaked in a hot 5% sodium bisulfite solution before removing from the clean box, and/or before rinsing and storing. Any electrical equipment that may be contaminated (even if suspected), such as hot plates and stirring equipment should be carefully wiped down with a rag soaked in a hot 5% sodium bisulfite solution followed by wiping down with a rag soaked in hot water. 3) The desired bromopicrin product should be stored in amber bottles, preferably non-breakable containers, and stored in a cool dry place away from sunlight. The bottles should also be placed inside an airtight sealed plastic bag, such as a 'ziplock' bag. 4) Storage of any and all disabling agents should be in cabinets, drawers, or the like, and said storage spaces should be equipped with proper ventilation. Use great care when handling bromine, and chlorine, both of which are very toxic and irritating. Use care when using potassium hydroxide, which can cause skin burns. Nitromethane is highly flammable, extinguish all flames before using. Carbon tetrachloride should be handled with care, as it is cumulative in the body

**Procedure:** Into a suitable flask, place 160 grams of bromine, and then bubble 116 grams of chlorine gas into the bromine over a period of about 3 or 4 hours. Afterwards, into a clean flask (equipped with two addition funnels, and electric stirrer; see figure 30), place 500 milliliters of carbon tetrachloride, 500 milliliters of water, and then 62 grams of nitromethane. Then place this mixture into an ice bath, and chill to 0 Celsius. Thereafter prepare a solution by adding and dissolving 56 grams of potassium hydroxide into 500 milliliters of cold water. Note: The addition of the potassium hydroxide to water produces much heat; allow this solution to cool to room temperature before using. Once the potassium hydroxide solution has cooled, place it into the first addition funnel. Then place the bromine/chlorine mixture into the other addition funnel, and then add both solutions (the potassium hydroxide solution, and the bromine/chlorine mixture) over a period of about 60 minutes while stirring the reaction mixture and keeping its temperature below 10 Celsius during both simultaneous additions. Note: the rate of addition of both solutions should be slightly even, with the bromine/chlorine mixture being added just slightly faster, so it's addition to the reaction mixture will be complete before the potassium hydroxides. After the addition of both solutions, stir the reaction mixture at below 10 Celsius for about 60 minutes, and then place the entire reaction mixture into a separatory funnel, and remove the lower organic layer. Thereafter, place this lower organic layer into a rotary evaporator, and evaporate-off the carbon tetrachloride under vacuum. After the carbon tetrachloride has been removed, the remaining residue will contain about 15% chlorodibromopicrin, 75% bromopicrin, and 10% inert impurities. This mixture can be used directly in military operations, if desired, when properly disseminated. Note: This mixture can be further purified by placing the remaining residue into a clean vacuum distillation apparatus, and fractionally distilling the mixture at 130 Celsius under a high vacuum to obtain a fraction containing 80% bromopicrin, and 20% chlorodibromopicrin. This mixture need not be purified any further for use in military operations.

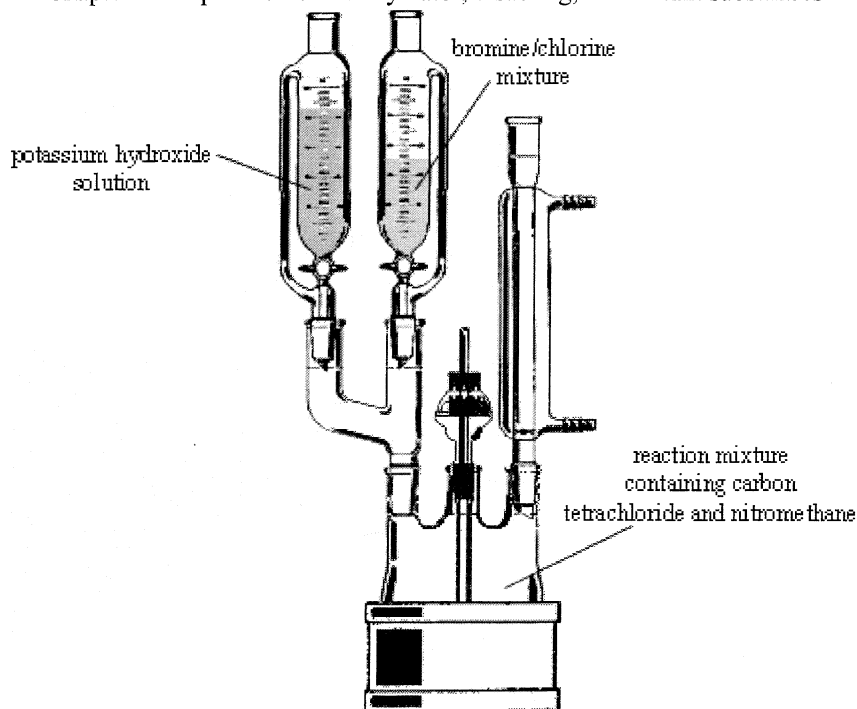
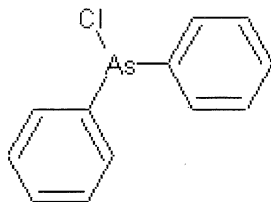


Figure 030. Setup for simultaneous addition of potassium hydroxide and bromine/chlorine mixture.

### 01-003. DA. Diphenylchloroarsine



Diphenylchloroarsine

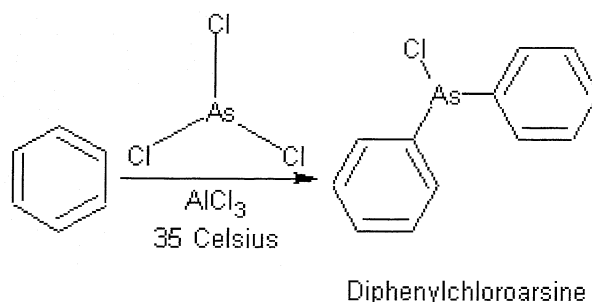
Diphenylchloroarsine forms colorless to brownish colored crystals, which are odorless. It has a melting point of 41 Celsius, and a boiling point of about 333 Celsius. When impure, it may begin to decompose when heated to 200+ Celsius. Diphenylchloroarsine is very stable, and its persistence in the environment is quite good; ranging from to 3 days to 2 weeks. Reports have stated its persistence in warm and dry climates to be as high 4 weeks under affluent conditions. Pure diphenylchloroarsine has no odor, but the impure agent may have a sharp biting or sour smell. It is an excellent vomiting agent, and it causes nausea and vomiting on inhalation or ingestion. Skin exposure to diphenylchloroarsine may cause localized irritation, followed by swelling. Diphenylchloroarsine is hardly ever fatal when inhaled. Diphenylchloroarsine produces immediate irritation upon inhalation, and hence the agent is easily detected. Inhalation of the agent also irritates the nose and throat, and produces cold like symptoms with stuffy nose, coughing, and headache. Skin absorption, inhalation, or ingestion seldom leads to systematic poisoning, even in high concentrations. Diphenylchloroarsine is an outstanding tear gas agent capable of dispersing large crowds of people immediately; however, due to certain human rights organizations, its use in riot control has been banned due to its "violent" nature as a riot control agent. Contact of the vapor with the eyes leads to immediate irritation, followed by runny eyes and redness, but the irritation is less than other arsenic agents. Its severe nature of producing nausea, vomiting, and headaches is the main reason its use has been banned as a riot control agent upon civilians; nevertheless, its use against military personnel is more than adequate to produce casualties. Personnel exposed to the agent will most likely have the urge to "flee", or run away from the contaminated area. Exposed personnel who put on their gas masks after said agent is detected or disseminated, will feel a strong urge to remove their masks due to feelings of "Confinement" and cold and flu like symptoms rendering coughing, clogged and congested nasal passages, general nose and throat irritation, headaches, and especially nausea and vomiting. As a result, diphenylchloroarsine can be used before hand, and/or along with lethal agents such as nerve agents or blood agents where it is desired to get personnel to remove their masks, thus exposing said personnel to the lethal nerve or blood agent in question. Diphenylchloroarsine should be disseminated in the form of aerosol or from pyrotechnic smoke generating munitions. **Diphenylchloroarsine is a fast acting incapacitating agent capable of producing casualties within minutes of**

dissemination. The agent is an extremely effective riot control agent, and vomiting agent. Minimum incapacitating dosage ranges from 5 to 15 milligrams through inhalation. The lethal dose through inhalation in the average man is as high as 8 grams per person; diphenylchloroarsine is regarded as non-toxic. Decontamination is not needed under most conditions.

OVERALL RATING (scale from 1 to 10)	
<i>Effectiveness (as disabling agent):</i> 9	<i>Field Stability:</i> 9
<i>Persistence (open area):</i> 8	<i>Storage stability:</i> 10
<i>Persistence (enclosed area):</i> 10	<i>Toxicity (as disabling agent):</i> 9
<b>TOTAL EFFECTIVENESS (as disabling agent):</b> 9.1	
<b>OVERALL TOXICITY (as warfare agent):</b> 1½	

### Procedure 1-003A: Preparation of Diphenylchloroarsine

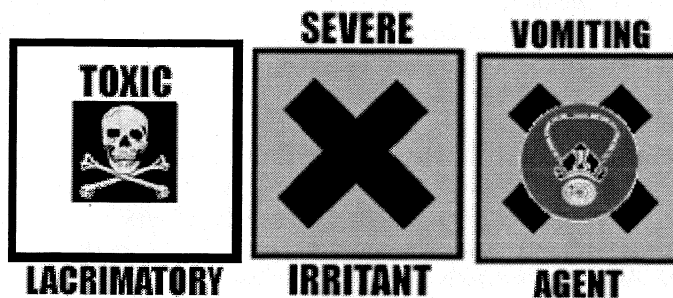
**Summary:** Diphenyldichloroarsine is readily prepared by reacting benzene with arsenic trichloride in the presence of anhydrous aluminum chloride. The anhydrous aluminum chloride catalyzes the reaction. After the reaction is over, the reaction mixture is washed with ice-cold water (to destroy the aluminum chloride, and dissolve hydrochloric acid), and the resulting mixture is then filtered to collect the solid diphenylchloroarsine. The Diphenylchloroarsine is then recrystallized from hexanes to yield highly pure diphenylchloroarsine.



*Reaction Equation (by products omitted)*

<b>Materials:</b>	1. 71 grams of dry benzene	3. 3 grams of anhydrous aluminum chloride
	2. 82 grams of anhydrous arsenic trichloride	4. 500 milliliters of dry hexanes

#### Hazards:

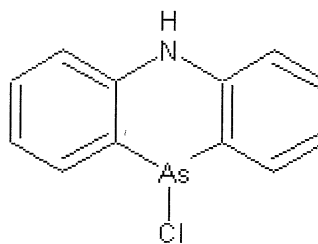


Do not attempt in anyway to prepare diphenylchloroarsine using the following procedure unless proper safety precautions are taken. 1) Perform all operations with good ventilation, maintain proper eye protection using eye wear that completely covers the eyes and forms a good seal on the face, and wear nitrile gloves. 2) After each procedure, all glassware and non-electric equipment should be soaked in bleach before removing from the clean box, and/or before rinsing and storing. Any electrical equipment that may be contaminated (even if suspected), such as hot plates and stirring equipment should be carefully wiped down with a rag soaked in bleach followed by wiping down with a rag soaked in hot water. 3) The desired diphenylchloroarsine product should be stored in amber bottles, preferably non-breakable containers, and stored in a cool dry place away from sunlight. The bottles should also be placed inside an airtight sealed plastic bag, such as a 'ziplock' bag. 4) Storage of any and all disabling agents should be in cabinets, drawers, or the like, and said storage spaces should be equipped with proper ventilation.

Use caution when handling arsenic trichloride, which is very toxic, and can be absorbed through the skin. Use care when handling anhydrous aluminum chloride, which reacts violently with water liberating much heat and toxic and corrosive gases. Benzene is a known carcinogen, wear gloves when handling, and avoid inhalation of vapors. Hexanes are highly flammable, so extinguish all flames before using to avoid possible explosions.

**Procedure:** Into a suitable flask equipped with mechanical stirrer, thermometer, and addition funnel, place 71 grams of benzene followed by 3 grams of anhydrous aluminum chloride. Then place the flask containing the benzene into a warm water bath and heat to 35 Celsius. Then place 82 grams of anhydrous arsenic trichloride into the addition funnel. Thereafter, slowly add drop wise, the arsenic trichloride to the benzene mixture over a period of several hours while keeping the temperature of the reaction mixture at 35 Celsius at all times. Note: During the addition, heat will be evolved. During the addition of the arsenic trichloride, vigorously stir the reaction mixture. After the addition of the arsenic trichloride, vigorously stir the reaction mixture for 1 hour at a temperature of about 35 Celsius, and then remove the warm water bath. Thereafter, allow the reaction mixture to cool to room temperature, and then place it into a cold-water bath and chill to 10 Celsius. Then quickly wash the reaction mixture (which will be mostly solid material) with 100 milliliters of pre chilled ice-cold water, and stir the mixture for several minutes. Afterwards, filter-off the insoluble diphenylchloroarsine solid, wash with 50 milliliters of ice-cold water (several times with the same washing portion), and then vacuum dry or air-dry the solid product under mild suction. Then recrystallize the solid product from 500 milliliters of dry hexanes, and after the recrystallization process, vacuum dry or air-dry the product under mild vacuum.

**01-004. DM. Adamsite. Phenarsazine chloride. Diphenylaminechloroarsine; 10-Chloro-5,10-dihydrophenarsazine**



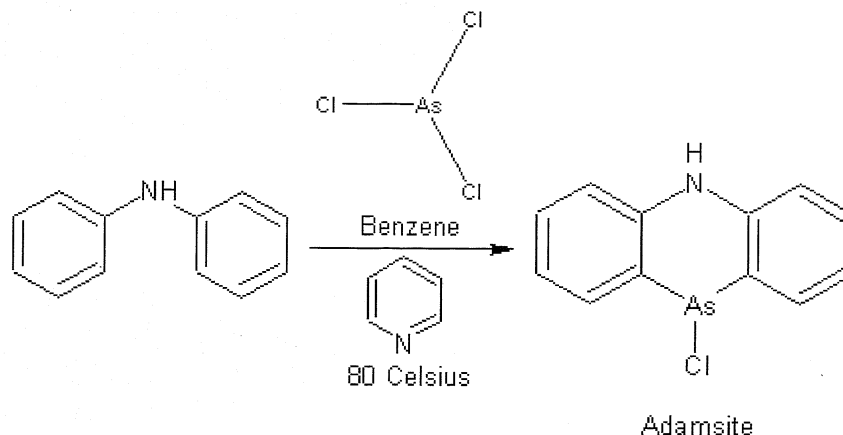
DM

Adamsite forms yellowish to canary-yellow crystals. Impure adamsite may have a greenish to yellowish green appearance. Adamsite has a melting point of 195 Celsius, and a boiling point of 410 Celsius (with decomposition starting at 400+ Celsius). Adamsite is not considered to be volatile under normal conditions, but it may demonstrate a slight degree of volatility under warm conditions. It can last in the environment for up to 2 weeks under normal environmental conditions. Adamsite can persist within enclosed areas for months, but due to the lack of volatility, this only poses a threat to skin contact. General skin contact can lead to mild irritation and itching, with larger concentrations of vapor or solid on the skin leading to severe itching; adamsite is not capable of producing soars, lesions, or blisters even under high concentrations. Adamsite is a vomiting agent similar to diphenylchloroarsine. It produces severe irritation upon inhalation leading to fluid build up and severe nasal congestion. Nausea and vomiting usually follows within minutes or hours after inhalation of the agent. Adamsite is relatively non-toxic, and its use in riot control has been approved by most agencies. A combination of adamsite and chloroacetophenone comprises common riot control mixtures used by police and law enforcement personnel. It is preferred to use adamsite alone or in combination with diphenylchloroarsine to harass, and irritate enemy personnel on the battlefield. As with other vomiting agents, any exposed personnel to the vapor will be left with severe congestion, irritation, and nausea making it very difficult for the exposed personnel to keep their gas masks on; as a result, adamsite can be used along with lethal agents to produce casualties on the battlefield. Adamsite is capable of producing eye irritation, but with a much lesser extent than other riot control agents. Adamsite primarily targets the nose and throat, and inhalation of the vapor produces immediate irritation followed by cold and flu like symptoms; effects such as headache, stuffy and congested nose, irritating soar throat, coughing, dizziness, nausea, and vomiting. Adamsite is readily destroyed by bleach, or strong alkalies. **Adamsite is a rapid fast acting vomiting and riot control agent capable of producing casualties within minutes of dissemination. The lethal dose through inhalation in the average man is about 3000 to 4000 milligrams per person, but may be as high 10,000 milligrams. Inhalation of as little as 10 milligrams can lead to irritation. Skin contact to small doses ranging from 5 to 15 milligrams may produce itching and general irritation. Eye exposure to adamsite may result in mild tearing and/or irritation. As little as 10 milligrams may produce tearing, but much higher concentrations are normally needed to effect the eyes.**

OVERALL RATING (scale from 1 to 10)	
<i>Effectiveness (as disabling agent): 7</i>	<i>Field Stability: 9</i>
<i>Persistence (open area): 9</i>	<i>Storage stability: 10</i>
<i>Persistence (enclosed area): 9</i>	<i>Toxicity (as disabling agent): 6</i>
<b>TOTAL EFFECTIVENESS (as disabling agent): 8.3</b>	
<b>OVERALL TOXICITY (as warfare agent): 1½</b>	

**Procedure 1-004A: Preparation of Adamsite**

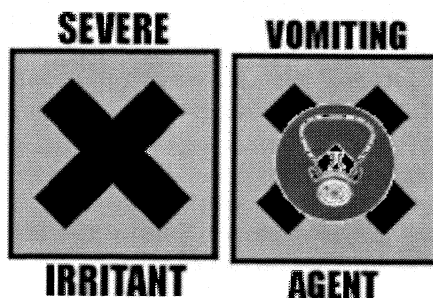
**Summary:** Adamsite can be prepared by refluxing diphenylamine with arsenic trichloride in benzene in the presence of pyridine. The pyridine acts as a hydrogen chloride scavenger, absorbing the hydrogen chloride emitted during the reaction. If the pyridine is to be omitted from the reaction, the released hydrogen chloride would react with the desired adamsite, forming the hydrochloride salt. After the reaction, the reaction mixture is filtered to remove insoluble adamsite, and pyridine hydrochloride. These resulting filtered-off solids are then treated with ice water to dissolve the pyridine hydrochloride, leaving the adamsite un-dissolved. The un-dissolved adamsite is then readily recovered by filtration. The recovered adamsite is then washed, and then dried.



*Reaction Equation (by products omitted)*

<b>Materials:</b>	1. 50 milliliters of benzene	3. 37 grams of diphenylamine
	2. 17 grams of pyridine	4. 39.6 grams of arsenic trichloride

**Hazards:**



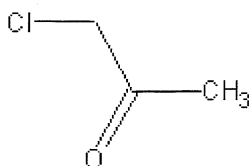
Do not attempt in anyway to prepare adamsite using the following procedure unless proper safety precautions are taken. 1) Perform all operations with good ventilation, maintain proper eye protection using eye wear that completely covers the eyes and forms a good seal on the face, and wear nitrile gloves. 2) After each procedure, all glassware and non-electric equipment should be soaked in bleach before removing from the clean box, and/or before rinsing and storing. Any electrical equipment that may be contaminated (even if suspected), such as hot plates and stirring equipment should be carefully wiped down with a rag soaked in bleach followed by wiping down with a rag soaked in hot water. 3) The desired adamsite product should be stored in amber bottles, preferably non-breakable containers, and stored in a cool dry place away from sunlight. The bottles should also be placed inside an airtight sealed plastic bag, such as a 'ziplock' bag. 4) Storage of any and all disabling agents should be in cabinets, drawers, or the like, and said storage spaces should be equipped with proper ventilation.

Use care when handling arsenic trichloride, which is very poisonous, and can be absorbed by the skin. Benzene is a known carcinogen, use care when handling, and avoid inhalation of the fumes.

**Procedure:** Into a suitable flask, add 50 milliliters of benzene, and 37 grams of diphenylamine. Then stir the mixture to dissolve the diphenylamine. When the diphenylamine dissolves, add 17 grams of pyridine, and then stir the mixture for 30 minutes at room temperature. Then bring the mixture to reflux at 80 Celsius with stirring. When the mixture reaches 80 Celsius under reflux, slowly add drop wise, 39.6 grams of arsenic trichloride over a period sufficient as to keep the reaction mixtures temperature around 80 Celsius. After the addition of the arsenic trichloride, continue to reflux the reaction mixture at 80 Celsius for 1 hour. Then remove the heat source, and allow the reaction mixture to cool to room temperature. Thereafter, place the reaction mixture into an ice bath and chill to 10 Celsius. Then filter-off all precipitated solids, and then place the filtered-off reaction mixture aside (will contain mostly benzene,

and some dissolved product). Then place the filtered-off solids into 500 milliliters of ice water, and then stir the mixture for about 1 hour. Thereafter, filter-off the un-dissolved solids, which will be the desired product, and then wash these solids with 100 milliliters of fresh ice water, and then vacuum dry or air-dry the solids. The result will be adamsite with a purity of about 98%. Note: some more adamsite can be obtained by evaporating the filtered-off reaction mixture (composed primarily of benzene), until dry solid remains. This dry remaining solid will be predominantly adamsite. Note: The aforementioned ice water previously filtered to recover the desired product will contain dissolved pyridine hydrochloride. This pyridine can be recovered by mixing with a warm solution of sodium carbonate, followed by distillation to recover the pyridine.

### 01-005. CA. Chloroacetone. 1-Chloro-2-propanone;



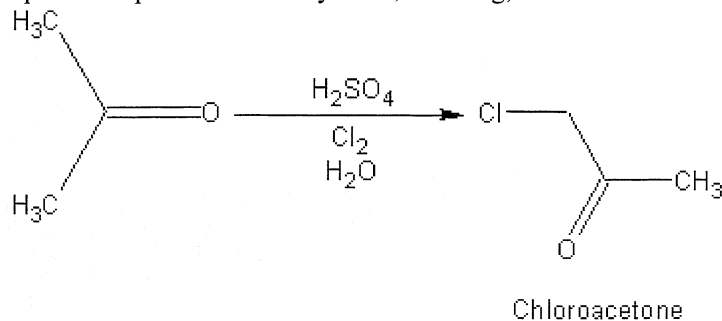
Chloroacetone

Chloroacetone forms a colorless slightly oily liquid with a pungent and irritating odor. It has a melting point of  $-45$  Celsius, and a boiling point of 120 Celsius. It is volatile with steam, and hence, can be steam distilled. Chloroacetone is soluble in water to about 10% by weight, but it is miscible with alcohol, ether, and chloroform. Pure chloroacetone tends to darken on exposure to light due to polymerization, and it can be stabilized by the addition of a small amount of water, or calcium carbonate. Chloroacetone is a potent eye irritant. Eye exposure to this agent produces severe eye pain and irritation; effects of which last for hours. Chloroacetone can be used in riot control operations, when diluted with water, or used in military operations when pure and stabilized. Chloroacetone is volatile under normal conditions, and its persistence in the environment is low; ranges from 8 hours to 2 days. Its persistence within enclosed areas can be from 12 hours to 1 week depending on ventilation, and rooms' contaminated with chloroacetone vapor can become uninhabitable for days. Inhalation of the vapor produces immediate and severe nose and throat irritation followed by congestion and soar throat; effects which are only short lived. The nasal passages are easily detoxified within minutes of exposure, and irritation and pain subside within a short time. Skin contact to the vapor or liquid can produce irritation, redness, and itching with effects lasting from a few minutes to several hours. Chloroacetone is a highly effective irritant, which can be used against rioters/protestors when diluted in water or other solvent, or on the battlefield to aggravate, harass, and confuse enemy troops when pure and stabilized. Chloroacetone is relatively nontoxic compared to other warfare agents, and it produces no permanent illness upon exposed personnel. Due to its severe irritation and acute toxicity to the eyes, chloroacetone can be used to incapacitate anyone exposed to it, whether disseminated in dilute solution or when pure. Exposed personnel to this agent through the eyes will suffer from severe eye pain, discomfort, and irritation for hours, making it almost impossible for the average person to carryout their normal duties. Chloroacetone can be disseminated from aerosols, explosives munitions, atomizers or humidifiers, and foggers. It is easily decontaminated with bleach, or strong alkali. **Chloroacetone is a fast acting irritant, capable of causing casualties within minutes of dissemination. Eye contact to as little as 1 milligram can cause pain and irritation. Skin contact to as little as 15 to 50 milligrams can lead to redness, rash, itching, and/or local discomfort. Inhalation of as little as 5 milligrams can lead to severe nose and throat irritation and discomfort. The lethal dose through inhalation can be as high 10,000 milligrams in the average person. The target organ of chloroacetone is the eyes, from which it is intensely irritating. Note: Solutions of chloroacetone in water can be used in "mace" type dispensing canisters, and it is 3 times more potent then original "mace", or "pepper" spray.**

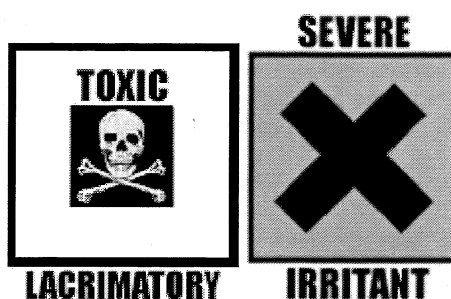
OVERALL RATING (scale from 1 to 10)	
<i>Effectiveness (as irritant agent):</i> 9	<i>Field Stability:</i> 8
<i>Persistence (open area):</i> 3	<i>Storage stability:</i> 8
<i>Persistence (enclosed area):</i> 7	<i>Toxicity (as irritant agent):</i> 9
<b>TOTAL EFFECTIVENESS (as irritant agent):</b> 7.3	
<b>OVERALL TOXICITY (as warfare agent):</b> 1¼	

### Procedure 1-005A: Preparation of Chloroacetone

**Summary:** Chloroacetone is readily prepared by reacting chlorine gas with an acetone solution in the presence of sulfuric acid. The reaction proceeds smoothly, without any excessive heat buildup. After the reaction, the resulting reaction mixture can then be used directly in riot control operations, or it can be purified by extraction with methylene chloride or chloroform. The resulting solvent extractions are then combined, and then evaporated to remove the solvent and leave behind the chloroacetone.

*Reaction Equation (by products omitted)*

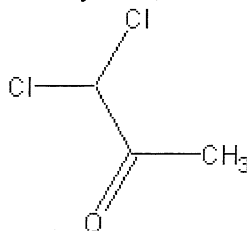
<b>Materials:</b>	1. 30 grams of acetone	4. 250 milliliters of methylene chloride or chloroform
	2. 5 small drops of 98% sulfuric acid	5. 10 grams of anhydrous calcium chloride
	3. 36.6 grams of chlorine gas	

**Hazards:**

Do not attempt in anyway to prepare chloroacetone using the following procedure unless proper safety precautions are taken. 1) Perform all operations with good ventilation, maintain proper eye protection using eye wear that completely covers the eyes and forms a good seal on the face, and wear nitrile gloves. 2) After each procedure, all glassware and non-electric equipment should be soaked in a hot sodium hydroxide solution before removing from the clean box, and/or before rinsing and storing. Any electrical equipment that may be contaminated (even if suspected), such as hot plates and stirring equipment should be carefully wiped down with a rag soaked in a hot sodium hydroxide solution followed by wiping down with a rag soaked in hot water. 3) The desired chloroacetone product should be stored in amber bottles, preferably non-breakable containers, and stored in a cool dry place away from sunlight. The bottles should also be placed inside an airtight sealed plastic bag, such as a 'ziplock' bag. 4) Storage of any and all irritant agents should be in cabinets, drawers, or the like, and said storage spaces should be equipped with proper ventilation. Acetone is highly flammable, extinguish all flames before using. Use caution when handling chlorine gas, which is very toxic and irritating.

**Procedure:** Into a suitable flask, place 30 grams of acetone, 550 milliliters of water, and then 5 small drops of 98% sulfuric acid. Thereafter, place the mixture into a cold-water bath, and chill to about 15 to 20 Celsius. Then bubble 36.6 grams of chlorine gas into the mixture over a period ranging from 2 to 6 hours. During the addition of the chlorine, continuously stir the acetone mixture. After the addition of the chlorine, stir the reaction mixture for 30 minutes, and then remove the cold-water bath. Note: The resulting reaction mixture at this point can be used directly in riot control operations. If the chloroacetone is to be used in military operations, it can be separated and purified by the following process: Extract the reaction mixture with five 50-milliliter portions of methylene chloride (or chloroform), and after each extraction, combine all extraction portions (if not already done so), and then dry the combined solvent extracts by adding 10 grams of anhydrous calcium chloride, and then stirring the mixture for several minutes; followed by filtration to remove the calcium chloride. Afterwards, place the filtered mixture into a rotary evaporator, or vacuum distillation apparatus and evaporate-off the solvent. Evaporation of the solvent will leave the chloroacetone behind, which it can then be recovered. The resulting chloroacetone should then be stabilized by the addition of 1 milliliter of regular tap water. The resulting chloroacetone should then be stored in an amber glass bottle in a refrigerator until use to prevent any possible polymerization.

**01-006. DCA. Dichloroacetone. 1,1-Dichloro-2-propanone; 1,1-dichloroacetone**



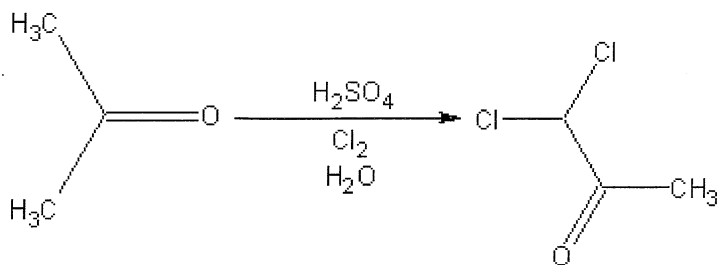
Dichloroacetone

Dichloroacetone is similar to chloroacetone in its effects and duration. It is an oily liquid with a boiling point of 120 Celsius. It is not very soluble in water, but its soluble in alcohol, and miscible with ether. Dichloroacetone is more persistent than chloroacetone, but it is still relatively volatile under normal conditions; its persistence in the environment ranges from 12 hours to 2 days. Dichloroacetone is intensely irritating to the eyes, nose, and throat. Like chloroacetone, rooms, tunnels, and the like contaminated with Dichloroacetone can become uninhabitable for days. Dichloroacetone is highly irritating to the eyes, from which it will produce severe eye pain and irritation; effects which can last for hours. Skin contact to the agent can produce irritation, itching, and redness. Reports have indicated that dichloroacetone may have vesicant properties, but this cannot be confirmed. Dichloroacetone can be used as an effective riot control agent, but its use in military operations is relatively limited. It can be disseminated from aerosols, explosives munitions, atomizers or humidifiers, and foggers. **Dichloroacetone is a fast acting irritant, capable of causing casualties within minutes of dissemination. Eye contact to as little as 3 milligrams can cause pain and irritation. Skin contact to as little as 12 to 50 milligrams can lead to redness, rash, itching, and/or local discomfort. Inhalation of as little as 5 milligrams can lead to severe nose and throat irritation and discomfort. The lethal dose through inhalation can be as high 10,000 milligrams in the average person. The target organ of dichloroacetone is the eyes, from which it is intensely irritating.**

OVERALL RATING (scale from 1 to 10)	
<i>Effectiveness (as irritant agent): 7</i>	<i>Field Stability: 8</i>
<i>Persistence (open area): 6</i>	<i>Storage stability: 8</i>
<i>Persistence (enclosed area): 9</i>	<i>Toxicity (as irritant agent): 9</i>
<b>TOTAL EFFECTIVENESS (as irritant agent): 7.8</b>	
<b>OVERALL TOXICITY (as warfare agent): 1½</b>	

### Procedure 1-006A: Preparation of Dichloroacetone

**Summary:** Dichloroacetone is readily prepared by simply bubbling chlorine gas into an acetone solution, in the presence of a small amount of concentrated sulfuric acid. The reaction is smooth, and without any excessive heat buildup. After the addition of the chlorine, the resulting two-layer mixture is then separated via a separatory funnel, and the drained-off dichloroacetone layer is then dried, and then stored until use.



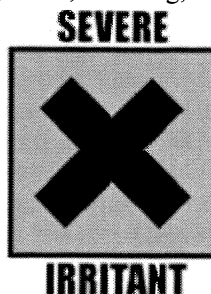
Dichloroacetone

#### Reaction Equation (by products omitted)

<b>Materials:</b>	1. 30 grams of acetone	3. 73 grams of chlorine
	2. 5 small drops of 98% sulfuric acid	4. 15 anhydrous calcium chloride

#### Hazards:



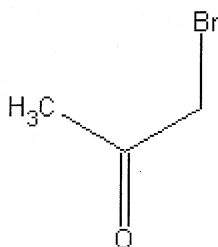


Do not attempt in anyway to prepare dichloroacetone using the following procedure unless proper safety precautions are taken. 1) Perform all operations with good ventilation, maintain proper eye protection using eye wear that completely covers the eyes and forms a good seal on the face, and wear nitrile gloves. 2) After each procedure, all glassware and non-electric equipment should be soaked in a hot sodium hydroxide solution before removing from the clean box, and/or before rinsing and storing. Any electrical equipment that may be contaminated (even if suspected), such as hot plates and stirring equipment should be carefully wiped down with a rag soaked in a hot sodium hydroxide solution followed by wiping down with a rag soaked in hot water. 3) The desired dichloroacetone product should be stored in amber bottles, preferably non-breakable containers, and stored in a cool dry place away from sunlight. The bottles should also be placed inside an airtight sealed plastic bag, such as a 'ziplock' bag. 4) Storage of any and all irritant agents should be in cabinets, drawers, or the like, and said storage spaces should be equipped with proper ventilation.

Acetone is highly flammable, extinguish all flames before using. Use caution when handling chlorine gas, which is very toxic and irritating.

**Procedure:** Into a suitable flask, place 30 grams of acetone, 75 milliliters of water, and then 5 small drops of 98% sulfuric acid. Thereafter, bubble 73 grams of chlorine gas into the mixture over a period ranging from 3 to 8 hours. During the addition of the chlorine, rapidly and continuously stir the acetone mixture. After the addition of the chlorine, place the entire reaction mixture into an ice bath, and chill to 5 Celsius. Then place the entire reaction mixture into a separatory funnel, and then drain-off the bottom oily layer, which will be predominantly dichloroacetone. Then dry this dichloroacetone layer by adding 15 grams of anhydrous calcium chloride, and then stir the mixture for several minutes; thereafter, filter-off the calcium chloride. The resulting dichloroacetone will be about 95% pure, and will contain small amounts of chloroacetone, 1,3-dichloroacetone, and hydrogen chloride. Note: This 95% pure dichloroacetone is well suitable for use in riot control operations, or military operations, and need not be purified. It should then be stored in an amber glass bottle in a refrigerator until use to prevent any possible polymerization.

### 01-007. BC. Bromoacetone. *1-Bromo-2-propanone*;



Bromoacetone

Bromoacetone forms an oily colorless liquid with a melting point of -36 Celsius, and a boiling point of 137 Celsius. It can be distilled at 64 Celsius under a vacuum of 50 milliliters of mercury. Bromoacetone tends to deteriorate on standing from which it turns violet in color, and may become turbid even in the absence of air; bromoacetone is relatively unstable and should be used within 1 month after preparation. It is insoluble in water, but soluble in alcohol, acetone and other common solvents. The persistence of bromoacetone in the environment is low, due to volatilization. Open areas contaminated with this agent will remain contaminated for several hours to several days under normal conditions. Within enclosed areas such as rooms, tunnels, bunkers, and the like, bromoacetone can persist for up to 1 week under poor ventilation conditions. Rooms contaminated with bromoacetone can become uninhabitable by persons for up to 1 week. Bromoacetone is a potent and violent lacrimator agent, and its use in riot control operations has been questioned due to its violent irritating nature. The vapor or liquid is highly irritating to the eyes, skin, nose, and throat. Eye contact will produce immediate and severe pain; effects which can last for hours. Inhalation of the vapor can lead to severe nose and throat irritation and discomfort with excessive fluid build-up and painful soar throat resulting within minutes. The vapor or liquid on the skin can produce irritation, itching, and soars within moments of contact leading to the possible formation of blisters within 8 hours. Bromoacetone is probably too violent in nature to be used as a riot control agent, but it can be highly effective on the battlefield. It can be used to

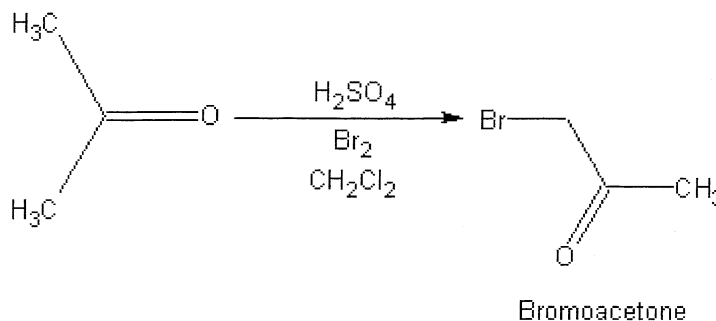
Chapter 4: Preparation of Lachrymator, disabling, and irritant substances

harass, confuse, and irritate enemy personnel. As with other irritants, bromoacetone is more effective at getting enemy personnel to de-mask shortly after being exposed to said agent. Personnel exposed to bromoacetone will quickly be overcome with severe eye irritation, nausea, itching, congestion, and soar throat that they will be unable to keep their gas masks on. Exposed personnel will have a great urge to flee the contaminated area immediately; hence bromoacetone could be used to warn-off intruders in classified or high security areas. Bromoacetone is best disseminated from aerosols, atomizers or humidifiers, or foggers. It can be easily decontaminated with bleach or strong alkali. **Bromoacetone is a rapid acting casualty producing agent capable of causing casualties within minutes of dissemination. Eye exposure to as little as 1 milligram can lead to pain and irritation. Inhalation of as little as 2 to 5 milligrams can lead to coughing, nose and throat irritation, and congestion. Inhalation of higher concentrations may lead to severe soar throat, nasal congestion, and serious discomfort. Skin contact to as little as 20 to 30 milligrams can produce irritation, itching, swelling, and general discomfort. Skin exposure to 50 to 100 milligrams may lead to blisters if untreated. The lethal dose through inhalation in the average man ranges from 2000 to 5000 milligrams per person.**

OVERALL RATING (scale from 1 to 10)	
<i>Effectiveness (as irritant agent):</i> 9	<i>Field Stability:</i> 5
<i>Persistence (open area):</i> 4	<i>Storage stability:</i> 2
<i>Persistence (enclosed area):</i> 6	<i>Toxicity (as irritant agent):</i> 10
<b>TOTAL EFFECTIVENESS (as irritant agent):</b> 6	
<b>OVERALL TOXICITY (as warfare agent):</b> 2	

**Procedure 1-007A: Preparation of Bromoacetone**

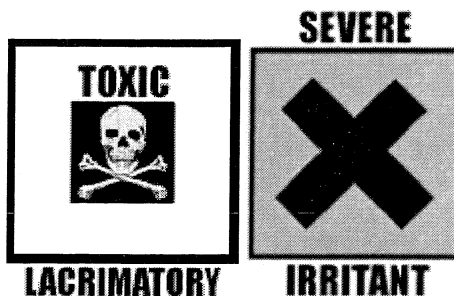
**Summary:** Bromoacetone is readily prepared by the reaction of bromine with acetone in the presence of sulfuric acid. The reaction takes place in methylene chloride solvent and at temperature just below room temperature. The reaction proceeds smoothly without any excessive heat build up. After the reaction, the reaction mixture is treated with ice water to remove the sulfuric acid, and the resulting two-layer mixture is then separated via a seperatory funnel. The lower methylene chloride layer is then evaporated to remove the solvent, and the resulting bromoacetone is simply recovered. The bromoacetone should be used within 1 month of preparation, as it will slowly decompose upon long standing. For long storage periods, the bromoacetone should be stored in a suitable solvent such as methylene chloride, chloroform, or any suitable solvent free from water.



*Reaction Equation (by products omitted)*

<b>Materials:</b>	1. 37 grams of acetone	3. 101 grams of bromine
	2. 5 small drops of 98% sulfuric acid	4. 300 milliliters of methylene chloride

**Hazards:**



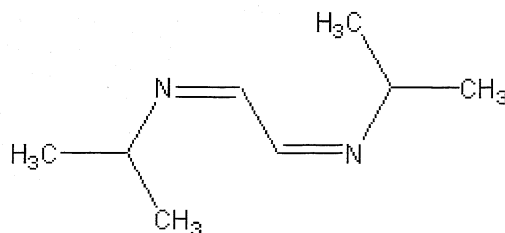
Do not attempt in anyway to prepare bromoacetone using the following procedure unless proper safety precautions are taken. 1) Perform all operations with good ventilation, maintain proper eye protection using eye wear that completely covers the eyes and forms a good seal on the face, and wear nitrile gloves. 2) After each procedure, all glassware and

Chapter 4: Preparation of Lachrymator, disabling, and irritant substances

non-electric equipment should be soaked in a hot sodium hydroxide solution before removing from the clean box, and/or before rinsing and storing. Any electrical equipment that may be contaminated (even if suspected), such as hot plates and stirring equipment should be carefully wiped down with a rag soaked in a hot sodium hydroxide solution followed by wiping down with a rag soaked in hot water. 3) The desired bromoacetone product should be stored in amber bottles, preferably non-breakable containers, and stored in a cool dry place away from sunlight. The bottles should also be placed inside an airtight sealed plastic bag, such as a 'ziplock' bag. 4) Storage of any and all irritant agents should be in cabinets, drawers, or the like, and said storage spaces should be equipped with proper ventilation. Acetone is highly flammable, extinguish all flames before using. Use caution when handling bromine, which is very toxic, irritating, and corrosive.

**Procedure:** Into a suitable flask, place 100 milliliters of methylene chloride, 37 grams of acetone, and then 5 small drops of 98% sulfuric acid. Thereafter, place this mixture into a cold-water bath, and chill to about 15 Celsius. Then prepare a bromine solution by adding and dissolving 101 grams of liquid bromine into 200 milliliters of methylene chloride, and then add drop wise, this bromine/methylene chloride solution to the acetone solution over a period of about 2 hours while vigorously stirring the acetone solution, and keeping its temperature below 20 Celsius. After the addition of bromine solution, continue to stir the reaction mixture for 1 hour at a temperature below 20 Celsius. Then add 100 milliliters of ice-cold water, and then stir the reaction mixture for 1 hour. Thereafter, place the reaction mixture into a separatory funnel, and remove the bottom methylene chloride layer. Then place this bottom methylene chloride layer into a rotary evaporator or vacuum distillation apparatus, and remove the solvent under mild vacuum, or through distillation at 40 Celsius. After the methylene chloride solvent has been removed, remove the remaining liquid (which is bromoacetone), and then store this liquid in an amber glass bottle in a refrigerator until use. The bromoacetone will have a purity of about 95%, and will contain small amounts of impurities, but this 95% pure bromoacetone is well suitable for field use. Note: If desired, this 95% bromoacetone can be distilled at 64 Celsius, and under a vacuum of 50 millimeters of mercury to obtain a purified bromoacetone product of 98% purity. Note: Purification of the bromoacetone is not required for general field use. Purification of the bromoacetone is desired only if the bromoacetone is to be combined with other agents. The 95% and 98% bromoacetone should be used within 1 month of preparation, as they will both slowly decompose upon long standing. For long storage periods, the bromoacetone should be stored in a suitable solvent such as methylene chloride, chloroform, or any suitable solvent free from water.

**01-008. DIIMINE. DIM. *N,N'*-bis-Isopropylethylenediimine**



DIIMINE

DIIMINE forms tan to lightly colored crystalline needles with a melting point of 48 Celsius. DIIMINE is soluble in the usual organic solvents. It is volatile under normal conditions, and can be readily sublimed at low temperature under vacuum. Due to DIIMINE's volatility, its persistence in the environment is very poor; it may last up to several hours under normal conditions. Its persistence within enclosed areas is improved, ranging from 2 to 12 hours under normal conditions, and rooms' contaminated with DIIMINE can be rendered uninhabitable for up to several hours. DIIMINE is an effective riot control agent, and its effects are instantaneous and severe. When disseminated under the usual techniques, it can render severe irritation to any exposed personnel. Inhalation of the agent produces the usual symptoms; irritation to the nose and throat with congestion and profuse nasal discharge. Eye exposure can lead to irritation and severe watering. The effects of exposure to DIIMINE are relatively short, lasting from 5 minutes to 1 hour, but the effects are severe. DIIMINE can be used in riot control operations for either police or other public authorities, or by military personnel for crowd control. DIIMINE is not suitable for battlefield use due to its short duration of effects. DIIMINE has little effect on the skin. It's most effectively disseminated through aerosols, smoke generating munitions, and explosives munitions. DIIMINE is readily decontaminated with bleach. **DIIMINE is a fast acting riot control agent capable of irritating exposed personnel within minutes of dissemination. Inhalation of as little 5 milligrams can lead to irritation and congestion. DIIMINE is not considered to be a skin irritant, but eye exposure to as little as 15 milligrams can lead to watering and eye irritation. The lethal dose through the average man is unknown, but is calculated to be very high; DIIMINE is regarded as non-toxic.**

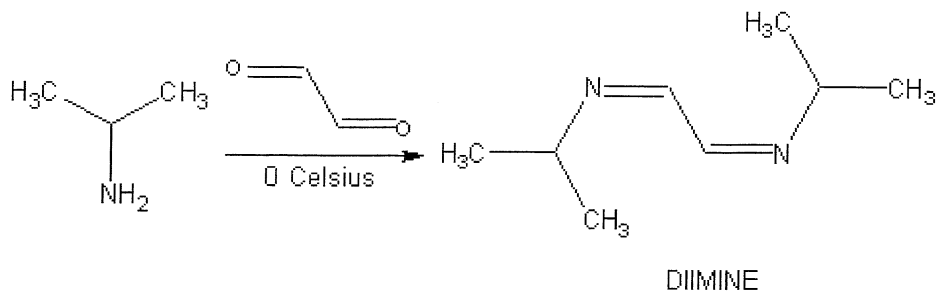
OVERALL RATING (scale from 1 to 10)	
<i>Effectiveness (as riot control agent):</i> 9	<i>Field Stability:</i> 9
<i>Persistence (open area):</i> 4	<i>Storage stability:</i> 9
<i>Persistence (enclosed area):</i> 4	<i>Toxicity (as riot control agent):</i> 8

TOTAL EFFECTIVENESS (as riot control agent): 7.1

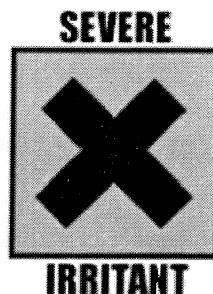
OVERALL TOXICITY (as warfare agent): 1

**Procedure 1-008A: Preparation of DIIMINE**

**Summary:** DIIMINE can be conveniently prepared by reacting a 40% glyoxal solution with isopropylamine at 0 Celsius. The reaction mixture is kept at 0 Celsius all through out the reaction, and the resulting reaction mixture is then allowed to stand. After standing the reaction mixture solidifies. The reaction mixture is then gently warmed to liquefy it, and it is then placed into a seperatory funnel while still molten to separate the two-layer mixture. The upper layer is recovered, and then dissolved into warm diethyl ether. This diethyl ether mixture is then placed into a dry ice bath, and the dissolved solid product is then allowed to self crystallize out of the diethyl ether solution. The precipitated crystals are then recovered by filtration, and then carefully dried. Note: The preparation of DIIMINE discussed in this procedure is similar or related to the process discussed in serial number 32,384, April 27<sup>th</sup>, 1970, by Jonathan M. Kliegman and Robert K. Barnes, both of Charleston, West VA; assigned to Union Carbide Corporation. This process may be protected by industrial/commercial process applications. Consult said application number before using the mentioned process for commercial or industrial purposes.

*Reaction Equation (by products omitted)*

<b>Materials:</b>	1. 118 grams of isopropylamine	3. 500 milliliters of diethyl ether
	2. 145 grams of 40% glyoxal solution	

**Hazards:**

Do not attempt in anyway to prepare DIIMINE using the following procedure unless proper safety precautions are taken. 1) Perform all operations with good ventilation, maintain proper eye protection using eye wear that completely covers the eyes and forms a good seal on the face, and wear nitrile gloves. 2) After each procedure, all glassware and non-electric equipment should be soaked in bleach before removing from the clean box, and/or before rinsing and storing. Any electrical equipment that may be contaminated (even if suspected), such as hot plates and stirring equipment should be carefully wiped down with a rag soaked in bleach followed by wiping down with a rag soaked in hot water. 3) The desired DIIMINE product should be stored in amber bottles, preferably non-breakable containers, and stored in a cool dry place away from sunlight. The bottles should also be placed inside an airtight sealed plastic bag, such as a 'ziplock' bag. 4) Storage of any and all riot control agents should be in cabinets, drawers, or the like, and said storage spaces should be equipped with proper ventilation.

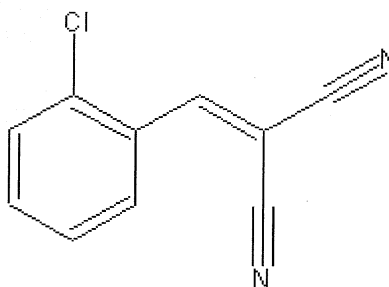
Use caution when handling isopropylamine, which is irritating and toxic. Diethyl ether is highly flammable and explosive. Extinguish all flames before using, and perform the peroxide test before using diethyl ether that has been in storage for long periods of time.

**Procedure:** Into a suitable flask, place 118 grams of isopropylamine, and then chill this flask to 0 Celsius by means of salt/ice bath. When the temperature of the isopropylamine reaches 0 Celsius, slowly add drop wise, 145 grams of a 40% glyoxal solution over a period sufficient to keep the reaction mixture at 0 Celsius at all times. During the addition of the 40% glyoxal solution, moderately stir

Chapter 4: Preparation of Lachrymator, disabling, and irritant substances

the reaction mixture. After the addition of the 40% glyoxal solution, remove the ice/salt bath, and then allow the reaction mixture to warm to room temperature. Thereafter, let the mixture stand for 2 days at room temperature. Note: After two days, the reaction mixture will be a semi-solid mass. After two days, gently warm the reaction mixture, which is a semi-solid mass until the reaction mixture becomes a liquid. At this point two layers will form. Then place this entire reaction mixture into a separatory funnel, and collect the upper liquid layer by removing the lower layer first. Note: The separatory funnel should be gently warmed as well to keep the two-layer reaction mixture liquid, so the upper layer can be efficiently separated and recovered. After the upper liquid layer has been removed, place it into a beaker, and allow it to stand until it solidifies. After it has solidified, place the solid mass into 500 milliliters of previously warmed diethyl ether, and stir it until it dissolves. Thereafter, place this diethyl ether mixture into a pure dry ice bath, and let it chill for several hours to precipitate the desired solid product. Then remove the diethyl ether mixture from the dry ice bath, and then filter-off the precipitated solid product, and then vacuum dry under a very mild vacuum, or allow it to air dry. Note: The drying process of the solid product should be handled with care, as the solid product is very volatile. The dry solid product will weight about 108 grams, and will be in the form of crystalline needles. Note: the resulting dry solid product should be stored in a desiccator in a refrigerator until use. The desiccator should be filled with anhydrous calcium chloride.

**01-009. CS. *o*-Chlorobenzal malononitrile;  $\beta,\beta$ -dicyano-*o*-chlorostyrene; *o*-Chlorobenzylidenemalononitrile**



CS

CS forms a white crystalline solid with a melting point of 95 Celsius. It has a pepper like smell in crystalline form, and an intense pungent odor when in vapor form. It can be distilled at 310 Celsius under standard atmospheric pressure. CS is only very slightly soluble in water, but soluble in acetone, dioxane, methylene chloride, and ethyl acetate. CS is a very common riot control agent used by the US military and civil police authorities. It is similar to DIIMINE in its rate of action and effects. Effects of exposure to CS are severe, but only last for periods ranging from 5 to 30 minutes. It can persist in the environment for only limited time; ranging from 1 hour two several days under normal conditions, but its regarded as non-persistent. CS in enclosed areas can persist for several hours to several days depending on ventilation conditions. Any rooms contaminated with CS will become uninhabitable for up to 12 hours or more. The vapor on inhalation cause immediate nose and throat irritation followed by profuse nasal congestion. Eye exposure also produces immediate irritation leading to severe tearing and drainage; excessive eye exposure to the vapor can lead to involuntary closing of the eye lids making exposed personnel unable to perform their regular duties. Skin exposure to the vapor can produce itching, irritation, and a sense of mild stinging or discomfort. CS can be used in military operations where it is desired to flush enemy personnel from rooms, bunkers, tunnels, or the like. CS has very little effect on the open battlefield. CS can easily be disseminated through aerosols, and smoke generating munitions. It should be decontaminated with hot soapy water, and the use of bleach should be avoided to prevent formation of cyanogen chloride. **CS is fast acting riot control agent capable of producing casualties within minutes of dissemination. Eye exposure to 15 to 20 milligrams can lead to severe tearing, and eye irritation. Inhalation of as little as 25 milligrams can lead to severe nose, and throat irritation leading to serious nasal congestion, coughing, and general discomfort. Skin contact to 100 to 500 milligrams of the vapor can lead to itching, stinging, and redness. CS is non-toxic.**

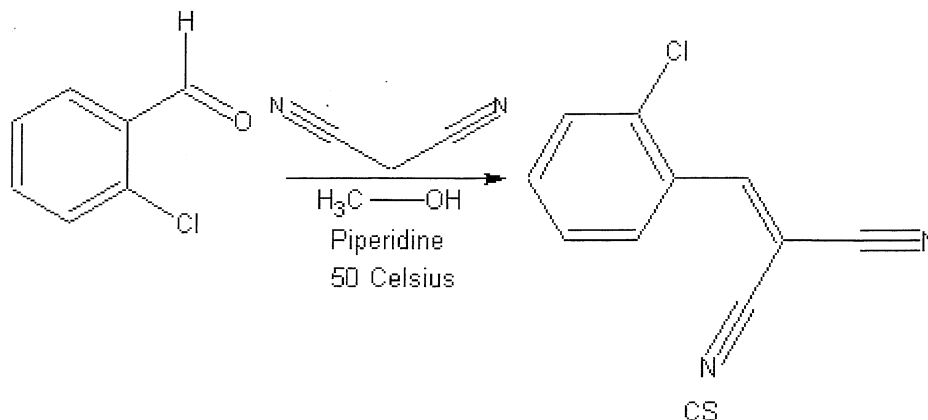
OVERALL RATING (scale from 1 to 10)	
<i>Effectiveness (as riot control agent): 8</i>	<i>Field Stability: 10</i>
<i>Persistence (open area): 5</i>	<i>Storage stability: 9</i>
<i>Persistence (enclosed area): 9</i>	<i>Toxicity (as riot control agent): 8</i>
<b>TOTAL EFFECTIVENESS (as riot control agent): 8.1</b>	
<b>OVERALL TOXICITY (as warfare agent): 1</b>	

**Procedure 1-009A: Preparation of CS**

**Summary:** CS is easily prepared by reacting chlorobenzaldehyde with malononitrile in the presence of a very small amount of piperidine catalyst. The reaction takes place in methanol, under mild conditions. The reaction is quick, and the resulting CS is

Chapter 4: Preparation of Lachrymator, disabling, and irritant substances

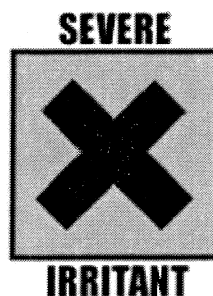
precipitated immediately after formation, from which it can be recovered by filtration. The resulting CS is then washed with a small amount of fresh methanol, followed by drying. Note: The preparation of CS discussed in this procedure is similar or related to the process discussed in application number 496,571, August 12<sup>th</sup>, 1974 by John S. Knapp, of Pittsburgh, PA, assigned by Federal Laboratories, Inc. This process may be protected by industrial/commercial process applications. Consult said application number before using the mentioned process for commercial or industrial purposes.



*Reaction Equation (by products omitted)*

<b>Materials:</b>	1. 2070 grams of methanol	3. 500 grams of o-chlorobenzaldehyde
	2. 230 grams of malononitrile	4. 800 milligrams of piperidine

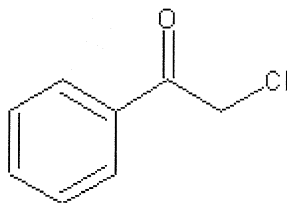
**Hazards:**



Do not attempt in anyway to prepare CS using the following procedure unless proper safety precautions are taken. 1) Perform all operations with good ventilation, maintain proper eye protection using eye wear that completely covers the eyes and forms a good seal on the face, and wear nitrile gloves. 2) After each procedure, all glassware and non-electric equipment should be soaked in hot soapy water before removing from the clean box (do not use bleach), and/or before rinsing and storing. Any electrical equipment that may be contaminated (even if suspected), such as hot plates and stirring equipment should be carefully wiped down with a rag soaked in a hot soapy solution (do not use bleach) followed by wiping down with a rag soaked in hot water. 3) The desired CS product should be stored in amber bottles, preferably non-breakable containers, and stored in a cool dry place away from sunlight. The bottles should also be placed inside an airtight sealed plastic bag, such as a 'ziplock' bag. 4) Storage of any and all riot control agents should be in cabinets, drawers, or the like, and said storage spaces should be equipped with proper ventilation. Use care when handling malononitrile and chlorobenzaldehyde, both of which are irritating and can be absorbed through the skin. Methanol is flammable, and poisonous; extinguish all flames before using, and avoid inhalation of the vapors.

**Procedure:** Into a suitable flask, place 1870 grams of methanol, followed by 230 grams of malononitrile, and then 500 grams of o-chlorobenzaldehyde. Thereafter, gently heat the mixture to 40 Celsius, while moderately stirring. When the temperature of the reaction mixture reaches 40 Celsius, carefully add 800 milligrams of piperidine, and then raise the temperature to 50 Celsius. Thereafter, heat the mixture at 50 Celsius with stirring for about 1 hour. After 1 hour, remove the heat source and allow the reaction mixture to cool to room temperature. Then filter the reaction mixture to recover the precipitated CS crystals, and then wash these recovered crystals with two 100-gram portions of fresh methanol. Then vacuum dry or air-dry the CS crystals. Note: these methanol washing portions can be added to the filtered reaction mixture, and this resulting filtered reaction mixture can be used in a second formation of CS, when using the same ingredients as just described (230 grams of malonitrile/500 grams of o-chlorobenzaldehyde; followed by 800 milligrams of piperidine catalyst; under the same conditions). The resulting dried CS crystals should then be stored in a cool dry place until use.

**01-010. CN. Chloroacetophenone. MACE. 2-Chloro-1-phenylethanone; 2-Chloroacetophenone**



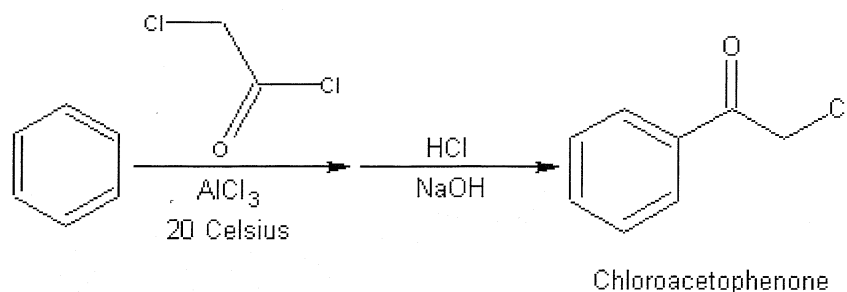
CN

CN forms colorless to white crystals with a melting point of 58 Celsius, and a boiling point 244 Celsius. The crystals have a slight apple odor, or odor of apple blossoms. The vapor has a characteristic pungent and irritating odor. CN is insoluble in water, but readily soluble in alcohol, chloroform, benzene, and hexanes. CN is a commonly used riot control agent used by police and civil authorities. CN is sometimes used by the military for riot control, especially when dissolved in chloroform, or benzene, but its overall use by the military is limited. CN causes general irritation to the nose, throat, and eyes. Eye exposure to the vapor causes moderate irritation with tearing and fluid drainage. Inhalation produces immediate irritation to the nose and throat leading to coughing, and congestion. Skin contact to CN can lead to mild irritation, and a sense of mild stinging under higher concentrations. The persistence of CN in the environment is very low; ranges from 30 minutes to several hours under normal conditions. CN can persist within enclosed areas for up to 2 days. CN is most commonly disseminated from smoke generating munitions, but numerous reports have noted that rioters and/or protestors can simply pick up the devices, and throw them back at the police. As a result, CN should be disseminated from aerosols for effective dissemination. CN can be decontaminated by washing with large amounts of hot soapy water. **CN is a fast acting riot control agent capable of dispersing personnel within minutes of dissemination. Eye exposure to 25 to 50 milligrams can produce irritation, and tearing. Inhalation of 50 to 80 milligrams can produce sneezing, coughing, irritation to nose and throat, and congestion. CN is regarded as non-toxic, but reports have shown chronic exposure may lead to slow systematic poisoning.**

OVERALL RATING (scale from 1 to 10)	
<i>Effectiveness (as riot control agent): 6</i>	<i>Field Stability: 9</i>
<i>Persistence (open area): 4</i>	<i>Storage stability: 9</i>
<i>Persistence (enclosed area): 5</i>	<i>Toxicity (as riot control agent): 7</i>
<b>TOTAL EFFECTIVENESS (as riot control agent): 6.6</b>	
<b>OVERALL TOXICITY (as warfare agent): 1</b>	

**Procedure 1-010A: Preparation of CN**

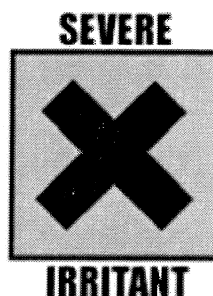
**Summary:** CN is readily prepared by reacting benzene with 2-chloroacetyl chloride in the presence of anhydrous aluminum chloride. The reaction is quite smooth, without much heat buildup. After the reaction, the reaction mixture is washed with acidic ice water, then with a sodium hydroxide solution, and then the resulting reaction mixture is treated with methylene chloride. The reaction mixture is then separated into two individual layers by the use of a separatory funnel. The removed methylene chloride layer is then evaporated to remove excess benzene, and to remove the methylene chloride solvent. The dry solid product is then recrystallized from hexanes. The collected crystals can be then dried via vacuum or air-dried.



*Reaction Equation (by products omitted)*

## Chapter 4: Preparation of Lachrymator, disabling, and irritant substances

<b>Materials:</b>	1. 100 grams of dry benzene	5. 35.7 grams of sodium hydroxide
	2. 3 grams of anhydrous aluminum chloride	6. 100 milliliters of methylene chloride
	3. 43 grams of 2-chloroacetyl chloride	7. 10 grams of anhydrous calcium chloride
	4. 7.5 milliliters of 35 to 38% hydrochloric acid	8. 300 milliliters of dry hexanes

**Hazards:**

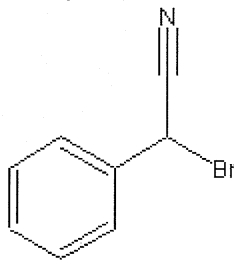
Do not attempt in anyway to prepare CN using the following procedure unless proper safety precautions are taken. 1) Perform all operations with good ventilation, maintain proper eye protection using eye wear that completely covers the eyes and forms a good seal on the face, and wear nitrile gloves. 2) After each procedure, all glassware and non-electric equipment should be soaked in hot soapy water before removing from the clean box (do not use bleach), and/or before rinsing and storing. Any electrical equipment that may be contaminated (even if suspected), such as hot plates and stirring equipment should be carefully wiped down with a rag soaked in a hot soapy solution (do not use bleach) followed by wiping down with a rag soaked in hot water. 3) The desired CN product should be stored in amber bottles, preferably non-breakable containers, and stored in a cool dry place away from sunlight. The bottles should also be placed inside an airtight sealed plastic bag, such as a 'ziplock' bag. 4) Storage of any and all riot control agents should be in cabinets, drawers, or the like, and said storage spaces should be equipped with proper ventilation.

Use caution when handling anhydrous aluminum chloride, which reacts with water producing toxic and corrosive fumes. Concentrated hydrochloric acid, and sodium hydroxide are corrosive to tissue, handle with care. Benzene is a known carcinogen, avoid inhalation of the vapors, and extinguish all flames before using; benzene is highly flammable. Use care when handling 2-chloroacetyl chloride, which is corrosive.

**Procedure:** Into a suitable flask, add 100 grams of dry benzene, and then add and dissolve 3 grams of anhydrous aluminum chloride. Thereafter, place this mixture into a cold-water bath, and chill to about 20 Celsius. Then slowly add drop wise, 43 grams of 2-chloroacetyl chloride over a period sufficient to keep the benzene mixture below 30 Celsius at all times. During the addition, rapidly stir the benzene mixture. After the addition of the 2-chloroacetyl chloride, continue to stir the reaction mixture for 1 hour at a temperature below 30 Celsius. Then add a solution prepared by adding 7.5 milliliters of 35 to 38% hydrochloric acid to 150 milliliters of ice water, and then add this acidic ice water solution to the reaction mixture at all once. Then stir the whole reaction mixture for about 20 minutes. Thereafter, carefully add a sodium hydroxide solution prepared by adding and dissolving 35.7 grams of sodium hydroxide into 564 milliliters of water, and then add this sodium hydroxide solution to the reaction mixture all at once. Note: Sodium hydroxide develops much heat when dissolved in water. Allow the sodium hydroxide solution to cool to room temperature, and then chill this sodium hydroxide solution to 5 Celsius by placing it into a freezer before adding it to the reaction mixture. After the addition of the sodium hydroxide solution, rapidly stir the whole reaction mixture for about 10 minutes. Thereafter, add 100 milliliters of methylene chloride to the reaction mixture, and then stir the reaction mixture for 30 minutes. Then place the reaction mixture into a separatory funnel, and drain-off the lower organic layer. Thereafter, quickly dry this lower organic layer by adding 10 grams of anhydrous calcium chloride, and then stir the mixture for 10 minutes; then filter-off the calcium chloride. Then place this filtered lower organic layer into a rotary evaporator, or vacuum distillation apparatus, and remove the methylene chloride, and excess benzene under vacuum until dry solid remains. When both solvents have been removed, and dry solid remains, remove this dry remaining solid, and then dissolve it into 300 milliliters of dry hexanes. Note: A small amount of the dry solid may not dissolve, if this is the case, filter-off these insoluble impurities. Thereafter, recrystallize the desired product from the hexanes, and afterwards, vacuum dry or air-dry the collected crystals. The result will be about 60+ grams of dry CN crystals. Note: The dry CN crystals should be stored in amber glass bottles in a cool dry place until use.

**01-011. BBC. Bromobenzylcyanide. Camite.  $\alpha$ -Bromobenzeneacetonitrile;  $\alpha$ -Bromo- $\alpha$ -tolunitrile**





BBC

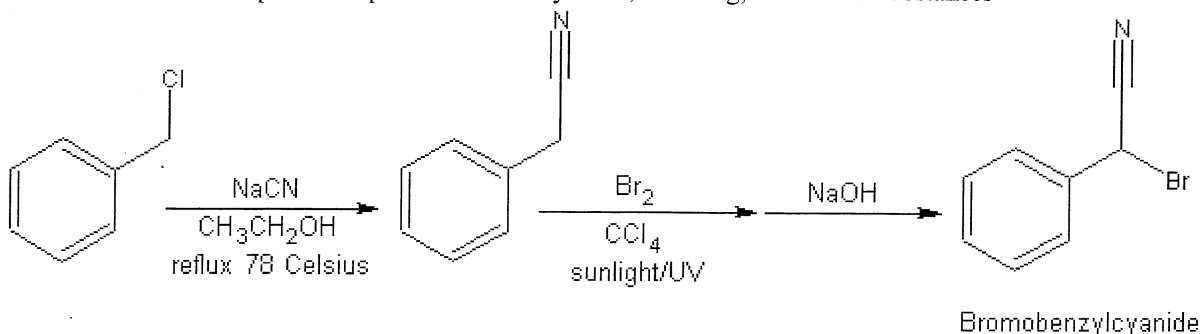
BBC forms a colorless to white crystalline mass with a melting point of 29 Celsius. The colorless to white crystalline mass may be a semi-solid mass. It has a boiling point of 242 Celsius (with decomposition beginning at 200+ Celsius), but it can be easily distilled at 132 Celsius under a vacuum of 12 millimeters of mercury. BBC has a peculiar and pungent odor of sour fruit, and the vapor has an irritating and biting odor, with a sweet after taste. BBC is freely soluble in alcohol, ether, chloroform, acetone, and other common organic solvents. It was once used in riot control and in military operations to train troops, but the toxicity of BBC has reduced its use. Inhalation of the agent in high, or even low concentrations can be fatal within 30 to 50 minutes. Despite the toxicity of BBC, it is still an excellent riot control agent, and incapacitating agent. It can be used on the battlefield to harass, confuse, and disorient enemy troops. Inhalation of BBC produces immediate irritation leading to congestion, and fluid discharge. Eye exposure produces immediate irritation followed by tearing. Skin contact to the agent can lead to mild irritation, but BBC is generally regarded as non-toxic to skin contact. One interesting fact about BBC is that it is most effective when used in dilute concentrations. Dilute concentrations of the agent actually produces more irritation to the eyes, nose, and throat than high concentrations. As a result, BBC can be spread over a wide area using smaller quantities, with greater success rates of personnel exposure. The persistence of BBC is very low, due to its volatility, and it lingers in the environment for only 30 minutes to 1 hour under normal conditions. As with most other riot control agents, its persistence within enclosed areas is greatly improved. BBC can be disseminated from aerosols, smoke generating munitions, and explosives munitions. BBC should be decontaminated with a solution of sodium hydroxide in ethyl alcohol; bleach should be avoided to prevent formation of cyanogen bromide. **BBC is a fast-acting casualty producing agent capable of producing casualties within minutes of dissemination. Eye contact to as little as 20 milligrams can produce irritation, redness, and watering. Inhalation of as little as 15 to 30 milligrams can lead to severe irritation, coughing, soar throat, congestion, and nasal discharges within minutes. The lethal dose through inhalation ranges from 2000 to 6000 milligrams per person. Note: Reports have shown that inhalation to as little as 900 milligrams per liter of air over a period of 30 minutes can be fatal. BBC tends to be more toxic when in smaller concentrations.**

OVERALL RATING (scale from 1 to 10)	
<i>Effectiveness (as riot control agent): 9</i>	<i>Field Stability: 8</i>
<i>Persistence (open area): 4</i>	<i>Storage stability: 8</i>
<i>Persistence (enclosed area): 8</i>	<i>Toxicity (as riot control agent): 10</i>
<b>TOTAL EFFECTIVENESS (as riot control agent): 7.8</b>	
<b>OVERALL TOXICITY (as warfare agent): 3½</b>	

### Procedure 1-011A: Preparation of BBC

**Summary:** BBC can be prepared in a two-step process, starting with the formation of benzyl cyanide. Benzyl cyanide is readily prepared by refluxing a mixture of benzyl chloride and sodium cyanide in ethanol. After the reaction, the reaction mixture is filtered to remove the insoluble sodium chloride, and then evaporated to remove the ethanol solvent. Thereafter, the remaining benzyl cyanide residue is then reacted with bromine in carbon tetrachloride solvent in presence of direct sunlight or UV light. During the reaction, hydrogen bromide gas is steadily evolved, so ventilation should be used just for precautions. After the reaction, the reaction mixture is washed with a dilute sodium hydroxide solution (to neutralize any hydrogen bromide), and the resulting two-layer mixture is then separated by draining-off the bottom organic layer. This bottom organic layer is then evaporated to remove the solvent, and the remaining product residue is then recrystallized from chloroform. The collected dried crystals should then be stored in a refrigerator until use.

Chapter 4: Preparation of Lachrymator, disabling, and irritant substances



*Reaction Equation (by products omitted)*

<b>Materials:</b>	1. 67 grams of benzyl chloride	5. 450 grams of carbon tetrachloride
	2. 26 grams of sodium cyanide	6. 21 grams of sodium hydroxide
	3. 474 grams of 95% ethyl alcohol	7.25 grams of anhydrous sodium sulfate
	4. 85 grams of liquid bromine	8. 150 grams of chloroform

**Hazards:**



Do not attempt in anyway to prepare BBC using the following procedure unless proper safety precautions are taken. 1) Perform all operations with good ventilation, maintain proper eye protection using eye wear that completely covers the eyes and forms a good seal on the face, and wear nitrile gloves. 2) After each procedure, all glassware and non-electric equipment should be soaked in hot basic solution made by dissolving sodium hydroxide into ethyl alcohol (20% solution by weight) before removing from the clean box, and/or before rinsing and storing. Note: Do not use bleach. Any electrical equipment that may be contaminated (even if suspected), such as hot plates and stirring equipment should be carefully wiped down with a rag soaked in a hot basic solution made by dissolving sodium hydroxide into ethyl alcohol (20% solution by weight) followed by wiping down with a rag soaked in hot water. Note: Do not use bleach. 3) The desired BBC product should be stored in amber bottles, preferably non-breakable containers, and stored in a cool dry place away from sunlight. The bottles should also be placed inside an airtight sealed plastic bag, such as a 'ziplock' bag. 4) Storage of any and all riot control agents should be in cabinets, drawers, or the like, and said storage spaces should be equipped with proper ventilation.

Use care when handling benzyl chloride, which is irritating and can be absorbed by the skin. Extinguish all flames before using 95% ethyl alcohol, which is very flammable. Handle sodium cyanide with care; skin absorption is rapid and highly toxic. Use great care when working with bromine, which is very toxic, corrosive, and irritating. Use proper ventilation when handling carbon tetrachloride, and avoid inhalation of the vapors at all cost. Use care when handling sodium hydroxide, which is capable of producing burns on the skin.

**Procedure:** Into a suitable flask, place 67 grams of benzyl chloride. Thereafter, prepare a solution by adding and dissolving 26 grams of dry sodium cyanide into 474 grams of 95% ethyl alcohol. Thereafter, carefully add this sodium cyanide/ethyl alcohol solution to the benzyl chloride over a period of about 30 minutes while stirring the benzyl chloride. After the addition of the sodium cyanide/ethyl alcohol solution, reflux the entire reaction mixture at 78 Celsius for 2 hours while stirring the reaction mixture. After refluxing the reaction mixture for 2 hours, remove the heat source, and allow the reaction mixture to cool to room temperature. Then filter the reaction mixture to remove insoluble impurities, and then place the filtered reaction mixture into a rotary evaporator or vacuum distillation apparatus, and remove the ethyl alcohol under vacuum. After the ethanol has been removed, remove the remaining residue (which will consist of benzyl cyanide), and place it into a clean flask. Thereafter, prepare a second solution by adding and dissolving 85 grams of liquid bromine into 450 grams of carbon tetrachloride. Then carefully add this bromine/carbon tetrachloride solution to the flask containing the residue of benzyl cyanide, and then stir the entire mixture to dissolve all products. Now, you can do either of the following: 1) place this flask containing the bromine/carbon tetrachloride/benzyl cyanide mixture onto a window ledge (with the window open), and allow the reaction mixture to be directly exposed to sunlight for 16 hours. 2) Instead of placing the bromine/carbon

#### Chapter 4: Preparation of Lachrymator, disabling, and irritant substances

tetrachloride/benzyl cyanide mixture onto a window ledge, place under a laboratory UV lamp of high power, and photolyze it for 12 hours. Note: During the exposure to the sunlight or UV light, the bromine in the mixture will react with the benzyl cyanide producing the desired product, and hydrogen bromide gas as a by-product; use proper ventilation. After the appropriate amount of time (direct sunlight: 16 hours, or UV lamp: 12 hours), remove the entire reaction mixture from the flask, and place it into a clean beaker. Then wash this reaction mixture with a basic solution prepared by adding and dissolving 21 grams of sodium hydroxide into 329 milliliters of water; add this sodium hydroxide solution to the reaction mixture all at once. Note: Sodium hydroxide generates much heat when dissolved in water. Allow this sodium hydroxide solution to cool to room temperature before adding it. After the addition of the sodium hydroxide solution, vigorously stir the entire reaction mixture for 30 minutes. Then place the entire reaction mixture into a separatory funnel, and remove the lower organic layer. Then dry this lower organic layer by adding 25 grams of anhydrous sodium sulfate, and then stir the mixture for several minutes; followed by filtration to remove the sodium sulfate. Then place the filtered organic layer into a rotary evaporator or vacuum distillation apparatus, and carefully remove the carbon tetrachloride under vacuum. When all the carbon tetrachloride has been removed, remove the remaining residue (which will contain the desired product as a semi-solid mass), and then dissolve it into 150 grams of chloroform. Then quickly filter the mixture to remove any insoluble materials. Thereafter, recrystallize the desired product (Note: During the recrystallization process, the concentrated chloroform solution should be chilled in an ice bath to precipitate the desired crystals) from this chloroform solution, and then carefully dry the collected crystals in a desiccator filled with anhydrous sodium sulfate in a refrigerator until dry. Thereafter, store the crystals in an amber glass bottle in a refrigerator until use.

# Section III

## BLOOD AGENTS

### Chapter 5: Physical Nature of Blood Agents

#### I. Cyanides

##### Introduction

Cyanide blood agents are a class of compounds that act upon the body in a similar manner as carbon monoxide. They poison the blood stream by reacting with the oxygen carries of the hemoglobin system. Blood agents also poison the organs by interfering with oxygen utilization within the cells. The cyanide blood agents are less likely to be encountered in warfare, but their use should not be underestimated. A common blood agent known as hydrogen cyanide was once used in gas chambers with excellent results, and the Nazi's used it to exterminate Jews during World War II. Most blood agents are very volatile, and their use in large open areas is limited. The term "blood agent" refers to cyanides, cyanogens, and phosgene class of compounds. Other classifications of blood agents exist, but will not be included in this book due to their non-military importance.

##### Physical properties (hydrogen cyanide)

The cyanides in this case refers to hydrogen cyanide, which is a colorless highly volatile liquid. It easily evaporates under normal conditions forming a colorless gas. The vapor is less dense than air, so it tends not to linger in low lining areas. The vapor in low concentrations has a faint odor of almonds, but in high concentrations, the vapor may go un-noticeable from odor alone. Hydrogen cyanide is very soluble in water, and it only hydrolyzes very slow in it. Hydrogen cyanide along with other cyanide agents are easily oxidized with nitric acid, potassium permanganate, or chromium trioxide in sulfuric acid.

Hydrogen cyanide is very flammable, and hence it cannot be disseminated fully from explosives munitions. It is easily neutralized in the body by the addition of sodium thiosulfate, and it readily forms complexes with alkali metals, i.e., potassium ferrocyanide. Hydrogen cyanide is not absorbed by charcoal very well, so certain gas masks may not provide adequate protection against this agent. Hydrogen cyanide effective gas masks contain metal salts impregnated in the filter to absorb hydrogen cyanide, but because exposure to hydrogen cyanide will most likely take place within confined areas, large amounts of the gas may be inhaled into the filter; as a result, the filter will soon become depleted, exposing the wearer to the lethal gas.

##### Detection

Automatic detectors are readily available for the detection of hydrogen cyanide in the field, or within enclosed areas. A number of laboratory monitors are also available. For soldiers in the field, Draeger tubes filled with a simple chemical gives rise to the presence of hydrogen cyanide, even in small concentrations. These Draeger tubes can be attached directly to the soldier, and give color indications in the presence of the agent. Test strips, and water testing kits are also available.

##### Protection

Ordinary clothing gives some protection against hydrogen cyanide; although it is recommended that certified chemical protective clothing or suits be worn, along with approved gas masks. As previously noted, hydrogen cyanide is not effectively removed with some gas masks, and gas masks that are effective at removing the agent should be changed immediately after use. Exposure for prolonged periods of time within contaminated environments may deplete the filter, thus exposing the agent to the wearer.

##### Decontamination

Due to the high degree of volatilization, no current method is necessary for the decontamination of hydrogen cyanide, or other cyanides. Within enclosed areas, the hydrogen cyanide can be neutralized by spraying fire extinguishers containing sodium carbonate; although, metal salts formed by neutralization of hydrogen cyanide can cling to walls, and contaminate equipment. Although not a threat to

inhalation, skin exposure to metal cyanides can still pose a threat, as they are easily absorbed through the skin. Liquid hydrogen cyanide on the skin is easily decontaminated by exposure to air (so the agent evaporates), or the skin can be flushed with water.

### **Mechanism of action within the body**

The cyanide ion forms a complex with the cytochrome oxidase enzyme within the respiratory system. This enzyme system is essential for the oxidative processes within cells. This complex formation interferes, and impairs the cellular oxygen system within the body, thus disrupting the oxygen utilization of the cells. The central nervous system is also affected by hydrogen cyanide, and death usually results from respiratory failure caused by an oxygen imbalance. The oxygen imbalance is the result of cyanides bonding to the hemoglobin oxygen carrier within the blood stream; in essence, the respiratory system becomes devoid of oxygen.

### **Signs and symptom of exposure**

The more rapid the body absorbs cyanide, the more acute are the signs and symptoms of poisoning. In high concentrations there is an increase in heart rate, and breathing becomes deeper within moments of exposure. Inhalation of the agents may produce stimulation of the breathing cycle so severe, that exposed personnel cannot even hold their breath. Violent convulsion usually follows within 30 seconds with cessation of respiration starting after 1 minute of exposure. Death usually occurs within 5 minutes of inhalation of lethal or high concentrations.

Exposure to low concentrations induces weakness in the legs, arms, and hands, and a general sense of depression or "heavy" feeling to the body. Nausea and headache usually follow exposure to low concentrations, and convulsions followed by coma is quite common. The onset of coma may last from only several hours, to several days. Long coma periods are a result of chronic exposure to low concentrations, and recovery may disclose damage to the central nervous system producing effects of irrationality, altered reflexes, unsteady attitude, depression, chronic headaches, and gait. In most cases, short-term exposure to low concentrations results in nausea, headache, and vertigo, effects which only last for several hours.

### **Treatment**

Treatment of cyanide poisoning depends upon the rapidness of treatment. In some cases, treatment of poisoning depends on the rate of cyanide fixation within the body. Some people are more cyanide "sensitive" than others, and these people are more difficult to treat especially after certain periods of time. Inhalation of lethal concentrations usually spells death for most exposed personnel within 10 minutes. Casualties exposed to low concentrations for short periods of time usually require no treatment, as symptoms dissipate after several hours. Personnel exposed to any level of hydrogen cyanide can be administered sodium thiosulfate solutions intravenously. The sodium thiosulfate interferes with the cyanide poisoning, and causes the body to detoxify it. As with most antidotes, the sodium thiosulfate has to be administered immediately after exposure.

Hydrogen cyanide poisoning can also be treated by the administration of dicobalt adetate, or by hydroxocobalamin. These two compounds provide secondary binding sites within the blood, thereby causing the cyanide to bond to them instead of the hemoglobin oxygen carriers. It has been reported that the two aforementioned compounds can be preadministered to prevent cyanide poisoning. This method of antidote should be administered immediately after exposure, and should be followed by treatment with sodium thiosulfate to prevent formation of cyanide complexes which may persist in the body and/or cause further intoxication; the sodium thiosulfate converts the cyanide to the water soluble thiocyanate, which is then easily flushed out through the urine.

Another less common form of treatment involves the production of methaemoglobin within the blood stream. This compound is made on site by administration of sodium nitrite, amyl nitrite, or dimethylaminophenol hydrochloride. Methaemoglobin binds rapidly and efficiently with cyanide ions and radicals, and hence can be used as an antidote to cyanide poisoning. This method of antidote should be administered immediately after exposure, and should be followed by treatment with sodium thiosulfate to prevent formation of cyanide complexes which may persist in the body and/or cause further intoxication; the sodium thiosulfate converts the cyanide to the water soluble thiocyanate, which is then easily flushed out through the urine.

### **Administration of cyanide antidotes**

Compounds that produce methaemoglobin include amyl nitrite, sodium nitrite, and dimethylaminophenol. For administration of amyl nitrite, a positive pressure respiratory system should be used. Simply put, the amyl nitrite should be administered through a facemask (similar to the doctor applying anesthetic). The amyl nitrite should be administered either pure or diluted with nitrogen. Note: amyl nitrite should not be administered with oxygen. After treatment with amyl nitrite, the patient should be administered sodium thiosulfate.

For treatment with sodium nitrite, a aqueous solution should be administered intravenously. This aqueous solution is prepared by dissolving 300 milligrams of sodium nitrite into 10 milliliters of water, and then intravenously administered over a period of 3 minutes. This intravenous dose should not be administered to children. After administration, the patient should be treated with sodium thiosulfate. Note: The sodium nitrite produces methaemoglobin, thus sequestering cyanide ion on the methaemoglobin. The cyanide is then removed by addition of sodium thiosulfate where it is converted into thiocyanate. The patient should be lying down when given

## Chapter 5: Physical Nature of Blood Agents

the injection of sodium nitrite. In some cases a decrease in blood pressure will occur, and slight development of cyanosis will occur as well. If this is the case, pure oxygen should be administered to the patient.

Treatment with dimethylaminophenol hydrochloride has proved very satisfactory in many cases. Dimethylaminophenol hydrochloride is very effective at producing methaemoglobin in the body, and can save the lives of those exposed to cyanide, but it is not a cure. Dimethylaminophenol should be administered intravenously at doses ranging from 150 to 250 milligrams per person. Muscular necrosis may follow intramuscularly injections, so direct injection into large muscle areas of the body should be avoided. The dosage of dimethylaminophenol should be carefully monitored, as too much can lead to an excess of methaemoglobin formation. If an overdose of dimethylaminophenol has been administered, oral doses of methylene blue can be administered to counteract this overdose.

Other cyanide antidotes include hydroxocobalamin (vitamin B12a), dicobalt edetate, and sodium thiosulfate. Hydroxocobalamin binds with cyanide ions to form cyanocobalamin (vitamin B12). This antidote should be administered intravenously, and in large doses.

Dicobalt edetate is given intravenously to treat persons exposed to cyanide. The dose usually ranges from 500 to 600 milligrams of dicobalt edetate. The dicobalt edetate is administered in the form a sugar solution. For administration, 40 milliliters of a solution prepared by dissolving 500 to 600 milligrams of dicobalt edetate into 40 milliliters of 30% glucose solution should be given. The injection should be followed by the usual injection of sodium thiosulfate. Note: Dicobalt edetate is poisonous to the kidneys, so administration should be monitored by medical personnel.

Sodium thiosulfate is the most common antidote administered to treat cyanide intoxication. Sodium thiosulfate combines with cyanide ions forming thiocyanate, which is easily removed from the body by urine. The sodium thiosulfate should be administered intravenously over a period of 10 minutes; 12.5 grams sodium thiosulfate dissolved in 25 milliliters of water.

After administration of any and all antidotes, a steady stream of pure oxygen should be administered.

## II. Cyanogens

### Introduction

Cyanogens are rapidly absorbed by the body either by inhalation, ingestion, or skin absorption, and they produce hydrogen cyanide within the body. They can penetrate into the body's blood stream, and be carried all throughout the body, where upon they release hydrogen cyanide in packets. The hydrogen cyanide is what directly poisons the body. Cyanogens are also irritants, and can produce skin burns and general irritation.

### Physical properties

The cyanogens are usually colorless to highly volatile liquids, or solids. Most of them are only slightly soluble in water, but readily soluble in most organic solvents. Cyanogens produce very irritating vapors, which are denser than air. Because of their densities, they tend to linger in low lying areas. Most cyanogens are very lachrymatory, and they are highly irritating to the eyes, nose, and throat. The cyanogens are very volatile, and their use on the battlefield is limited; they quickly volatilize, and are swept away by the slightest breeze. Cyanogens are very effective when used within enclosed areas.

Cyanogens are poorly absorbed by charcoal, aluminum oxide, or silica, so they may not be removed from certain gas masks. Gas mask canisters designed specifically for hydrogen cyanide, may not work very well with cyanogens. The cyanogen compounds do not readily react with the salts used in certain gas masks to absorb hydrogen cyanide, so the cyanogens are likely to be encountered in chemical warfare operations where cyanide is utilized. For most operations involving cyanogens, special gas masks are needed, along with special chemical suits. Cyanogens can penetrate certain clothing, fabrics, resins, and even some plastics. **Note: Most militaries are not equipped to adequately protect their troops against cyanogen attacks.**

### Detection

Even though cyanogens are difficult to protect against, their presence in the field is easily detected. Their highly irritating and biting nature suggests their presence, and automatic detector systems are readily available. Individual soldiers may also be easily equipped with test strips, which change to specific colors when traces of cyanogens are present. Because of the volatility of cyanogens, most contaminated environments will not remain contaminated for very long, so troops can adequately escape the contaminated areas; the exception being enclosed areas such as bunkers, tunnels, holes, etc.,

### Decontamination

See cyanides

### Mechanism of action within the body

The cyanogens act in a similar manner as cyanides, except with delayed action. The delayed action is the result of absorption into the blood stream, followed by breakdown into cyanide. Because direct inhalation, ingestion, or absorption does not lead to cyanide poisoning, cyanogens can migrate throughout the body covering large areas, where upon they are decomposed into cyanide and chloride ion. The cyanide ions then react with the oxygen carriers within the blood and cells. The direct systematic intoxication effects are identical to cyanide, see *vide supra*.

Another effect of cyanogens is their lachrymatory effects upon the body. Cyanogens injure the respiratory tract, and cause severe inflammatory changes in the bronchioles and causes congestion and oedema within the lungs. Low concentrations cause irritation to the eyes, and higher concentrations on the skin can cause burns, redness, and irritation.

### Signs and symptoms of exposure

In general, symptoms of exposure mimic that of hydrogen cyanide yet combined with an irritant. Cyanogens stimulate the respiratory center and rapidly cause paralysis. In high concentrations, its irritant action is so intense that dyspnoea may be produced. Exposure to low or high concentrations is followed by irritation to the nose, throat, and eyes. Coughing, tightness in chest, and lachrymation are also produced from inhalation or skin contact. After direct exposure to low or high concentrations, the exposed person may become dizzy and dyspnoeic. Unconsciousness usually follows the dizziness, and death follows respiratory arrest, which can occur within minutes of unconsciousness.

Other symptoms of exposure to cyanogens include convulsions, retching, and involuntary defecation of bodily waste products. In mild exposures, which are not commonly fatal, signs and symptoms of pulmonary oedema may develop. Other cases of mild exposure may develop coughing with much frothy sputum, rales in the chest, severe dyspnoea with cyanosis.

### Treatment

Treatment of cyanogen poisoning is the same as for cyanides, see *vide supra*. Treatment of cyanogen lachrymations should be the same for phosgene, see *vide supra*.

In most cases, recovery from cyanogen poisoning is similar to the affects of hydrogen cyanide, but residual damage to the central nervous system results in most cyanogen cases as opposed to cyanide cases. Different concentrations of cyanogen poisoning differ in the amount of residual damage to the body, but in most cases pulmonary effects may develop immediately, or may be delayed until after the systematic effects have dissipated; meaning recovering patients may develop symptoms after they have been cleared.

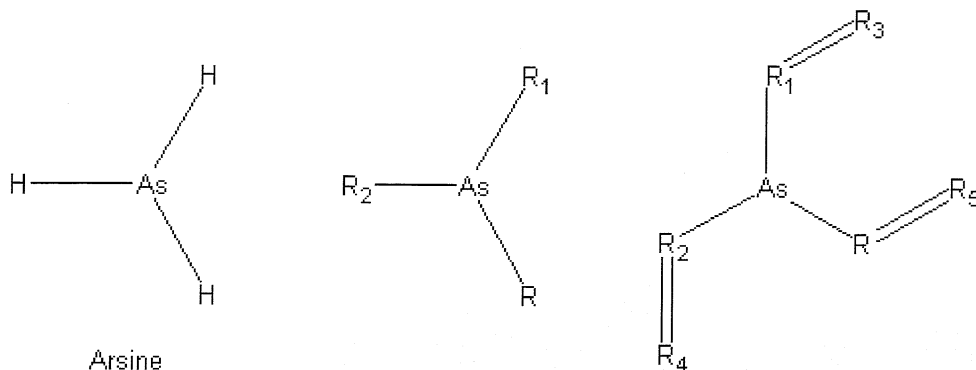
## III. Arsines

### Introduction

Arsines are colorless gases with disagreeable odors, or colorless liquids with varying odors. The most common arsine is "Arsine", which is used with limited effect in chemical warfare. Most arsines are considered not toxic enough in nature to act as warfare agents, but a few have very poisonous effects upon the body. The arsines are insoluble in water, but soluble in the usual organic solvents. They can be easily oxidized with the usual oxidizers including bleach, chromium trioxide, hydrogen peroxide, nitric acid, and even hot concentrated sulfuric acid.

### Physical properties

Arsines are composed of a central arsenic atom, which is bonded to either hydrogen and/or carbon. Arsines do not contain halogen atoms. The following illustration represents the backbone structures of arsines. All the R groups of the central illustration represent either hydrogen and/or carbon, with the R, R<sub>1</sub>, R<sub>2</sub>, R<sub>3</sub>, R<sub>4</sub>, and R<sub>5</sub> groups on the far right structure of the illustration representing carbon.



The most important arsine, Arsine is a colorless gas with a melting point of  $-117$  Celsius, and a boiling point of  $-63$  Celsius. It can be condensed into a liquid under pressure and cooling. Arsine has a distinct metallic garlic odor, and can be detected by smell from reacting hydrochloric acid with cast iron; where it is liberated in very small quantities. Other arsines are colorless liquids, which are volatile under normal conditions.

### **Mechanism of action within the body**

Arsines are not blood agents in the usual sense, and they do not bond with oxygen carriers in the blood stream. Arsines poison the kidneys, and liver resulting in permanent damage. They also combine with various compounds in the brain producing peripheral neuropathy. The direct mechanism of action is relatively unknown, and reports have indicated that arsines can react with the DNA and RNA of persons resulting in long term illness. Chronic exposure is the leading result of long-term illness, and has been experienced by occupational workers. Some reports have indicated that arsines are carcinogenic, but other reports show that they are not.

### **Signs and symptoms of exposure**

Exposure to arsines can produce a varying degree of symptoms, but usually includes headache, dizziness, weakness, followed by dyspnea and abdominal back pain. Exposure to arsine produces no effects upon the eyes, and inhalation yields no irritation to the nose and throat. Inhalation produces a headache within moments of exposure, and it's usually the first symptom along with weakness and dizziness. Symptoms such as nausea, vomiting, hematuria, and jaundice usually follow within 30 minutes to an hour. Inhalation of high concentrations is easily fatal within 4 hours. Chronic exposure, or exposure to low concentrations usually results with hematuria, peripheral neuropathy, and development of a syndrome known as bronze skin.

Other symptoms, yet low key symptoms from exposure include metallic taste in mouth, dry lips, difficulty in breathing or tightness of chest, and tingly sensations in different parts of the body.

### **Treatment**

There is no effective treatment for arsine poisoning, but patients should be taken to fresh air, and given lots of water to drink. Saline solutions can be administered intravenously along with several known anti-arsenic antidotes. These antidotes may not directly treat the arsine contamination, but may help convert them into water soluble arsenic compounds. It is known that arsine is converted into water soluble compounds within the lungs, but that the rates of detoxification may vary; as a result, patients should be ordered to run around so as to speed up the bodies respiration to allow the lungs to cleanse themselves more thoroughly. Even though the lungs can detoxify arsines, there is little that can be done to prevent arsines from entering the blood stream.

## **IV. Phosgene**

### **Introduction**

Phosgene belongs to a family of compounds known as "choking agents". Choking agents produce severe irritation to the nose, throat, and respiratory tract, resulting in excessive fluid discharge. This fluid discharge can be so severe, that a suffocating effect is produced within in the lungs, causing the person to die from lack of oxygen. Although phosgene is not a blood agent in the usual sense, it is classified however in the blood agent family because of its oxygen suppressing nature. Similar agents to phosgene include: chlorine, bromine, nitrogen dioxide, nitric oxide, and diphosgene; although these agents will not be discussed. In general, phosgene is considered a lung-damaging agent, and it is highly effective in this regard. Phosgene was used by the Germans during World War I, where it accounted for 80% of all chemical warfare casualties.

### **Physical properties of phosgene**

Normally, phosgene is a colorless gas, which liquefies at 5 Celsius forming a colorless to light yellow liquid. Its density is much higher than air, so it tends to linger around low lying areas; although, its volatility is so great that its persistence in the environment is very poor. Even though its persistence in the environment is poor, it may linger in trenches, bunkers, tunnels, and holes for prolonged periods of time; especially in warm and calm weather.

In low concentrations, it has the odor of freshly cut hay. It is very soluble in most common organic solvents, and very soluble in fats and oils. Phosgene is insoluble in water, and it is only slowly hydrolyzed by it; alkali solutions and strong oxidizers accelerate this decomposition.

### **Detection**



Phosgene in the field is almost impossible to detect by smell. Low concentrations may have odors of freshly cut hay, but these odors may blend in to the surrounding environment. There are no electronic devices to detect phosgene, although some vehicles can detect it through gas chromatography. There are no test strips available for its detection either, and no evidence of its presence may exist until personnel develop symptoms from exposure.

## Protection

Ordinary clothing is satisfactory for protection against this agent, and ordinary gas mask provides adequate protection.

## Decontamination

Under most conditions, decontamination is not needed due to its volatility; it will simply blow away under the slightest wind. Within tunnels, bunkers, and trenches, decontamination is swift and rapid with mild ventilation. During very cold weather, decontamination is accomplished by treatment with bleach, or caustic soda.

## Mechanism of action within the body

When phosgene is inhaled, it reacts directly with the alveoli and capillary wall, which permits plasma to flood the alveoli. This effect is usually reached within 12 to 24 hours of exposure. Phosgene increases the permeability of the alveolar capillaries, which produces severe pulmonary oedema. This acute action interferes with the pulmonary gaseous exchange within the lungs, leading to hypoxia. The loss of fluid into the alveoli also produces a syndrome called haemoconcentration, which along with hypoxia, causes cardiac distress and in which may lead to cardiac failure. Other methods of action include inhibition of enzymes, and the production of hydrogen chloride within the lungs and blood stream, especially within the alveoli.

Phosgene is a severe poison, which produces massive pulmonary oedema. This effect is preceded by reputable damage to the bronchiolar epitheliums. Devolvement of patches on the emphyema, acute atelectasis, and oedema of the perivascular connective tissue also result from the severity of the pulmonary oedema. During the intoxicification of the lungs with phosgene, oedema produces fluid, which is usually frothy and pours from the bronchi and can be seen escaping from the mouth and nose.

With exposure to high concentrations, death usually occurs within several hours. In most fatal cases, pulmonary oedema reaches its maximum effect within 12 hours, followed by death within 24 to 48 hours due to suffocation and cardiac distress.

## Signs and symptoms

Skin or eye contact to the gas produces virtually no symptoms, but exposure to the liquid may produce skin and eye irritation. In most cases, eye and skin contact is not regarded as a threat in field operations. When the gas is inhaled, coughing, choking, feelings of tightness in the chest, nausea, and mild vomiting immediately occur. This effect is true for both low concentrations, and high concentrations. In some cases headache and lachrymation occur after inhalation of low or mild concentrations. Some cases will show remarkable lung resistance, but with severe cough, headache, and congestion. In most cases, inhalation of the gas leads to respiratory tract irritations, followed by pulmonary oedema. There may exist an initial slowing of the pulse rate, followed by an increase. Abnormal chest pains may follow, and may lead to severe cardiac distress. Some cases of exposure will show delayed action, meaning after the initial exposure, victims may show no appreciable signs or symptoms for several hours; whereupon the aforementioned symptoms will develop.

Exposure to mild or high concentrations starts with coughing, dyspnoea, rapid and shallow breathing, followed by cyanoses. Nausea and vomiting may occur within hours of exposure, and is usually followed by oedema progression leading to respiratory discomfort and frothy sputum. The latter develops when the dyspnoea increases. Rales and rhonchi develop throughout the chest, and breathing sounds may be reduced to a wheezing, or diminished breathing sound. Later, the exposed person may develop shock-like symptoms, resulting in pale skin, clammy hands, and low blood pressure.

## Treatment

There are no real methods of treatment, but one common method of preventing exposed personnel from dying as a result of exposure is rest and warmth. Casualties caused by phosgene inhalation should be kept at a state of rest and calm. In most cases the pulmonary oedema will pass if the exposed person remains calm and restful. Active troops exposed to phosgene will soon be overcome with congestion, and a sense of suffocation; actively working troops tend to accelerate the suffocating effects.

In some cases it will be necessary to drug exposed personnel in order to keep them calm. In this case, sedatives are administered to the patient. Codeine can be administered orally at 30 to 60 milligram doses to suppress cough. Sedation can result in restlessness causing hypoxia; as a result, the use of sedatives should be given only for severe cases, and after administration of oxygen.

Administration of oxygen can be very effective at treating mild to moderate cases of exposure. Hypoxaemia can be reduced by the administration of oxygen, and administration of oxygen can also reduce or delay the effects of pulmonary oedema.

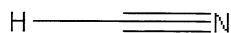
### Chapter 5: Physical Nature of Blood Agents

In some cases, bacterial bronchitis/pneumonitis may result from exposure to phosgene. In this case, antibiotics can be administered; although, antibacterials should not be administered in all exposure cases, as they will not be needed.

One method of dealing with phosgene exposure is the administration of steroids. Administrations of corticosteroids may lessen the severity of pulmonary oedema. In any case, steroids should be administered within 15 minutes of exposure. The doses of steroid administered should be greater than that for the treatment of asthma, and they should be intravenously administered.

# Chapter 6: The Preparation of blood agents

## 02-001. AC. Hydrogen cyanide. *Hydrocyanic acid; Prussic acid; Blausaure*



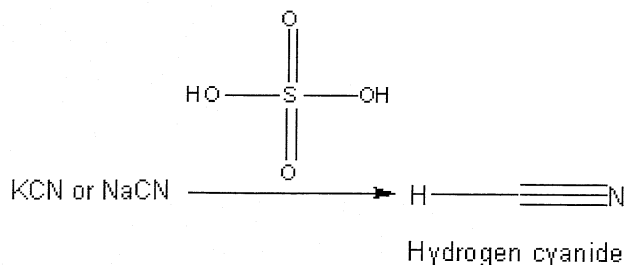
AC

Hydrogen cyanide forms a colorless gas or liquid, with a characteristic odor. The pure liquid has a mild biting or acrid smell, but dilute vapor or liquid has an odor of almonds. In some cases the vapor or liquid may have a bitter or burnt odor of almond. The liquid and gas is flammable, burning with a bluish flame. It has melting point of  $-13$  Celsius, and a boiling point of  $26$  Celsius. Hydrogen cyanide is easily condensed into a liquid, but it is highly volatile under normal conditions. Because of hydrogen cyanides high rate of volatilization, it is not well suitable for field operations; although, its use in cold climates can be effective. Environments exposed to hydrogen cyanide are easily self-decontaminated within minutes due to wind, water, and other environmental conditions. Hydrogen cyanide has relatively no environmental persistence, although persistence in cold climates may range for up to 12 hours. It is miscible with water and alcohol, and it is slightly soluble in ether. Within enclosed environments, hydrogen cyanide is highly effective, being one of the most effective lethal agents when used in enclosed areas such as bunkers, rooms, buildings, tunnels, and the like. Inhalation of as little as 900 parts per million over a time period of 15 minutes can cause death. Hydrogen cyanide is very stable, and can persist in enclosed areas for months. It is rendered volatilization inactive when treated with alkalis, but formation of cyanide salts still presents a danger through skin contact. Bleaching powder decomposes hydrogen cyanide with some evolution of the highly toxic cyanogen chloride. Hydrogen cyanide is an effective blood agent, which was formerly used in gas chambers. It is highly toxic, and the lethal dose for the average man through inhalation may be as low as 60 milligrams. Exposure to low concentrations of hydrogen cyanide over time can lead to paralysis, unconsciousness, and respiratory arrest. Hydrogen cyanide is a very common poison, being used in capital punishment, and in rodent extermination. Chemical munitions should utilize aerosol techniques for dissemination in military operations. **Hydrogen cyanide is deadly poison capable of producing casualties within minutes of dissemination. Exposure to small amounts of vapor can lead to nausea, and repository illness. Lethal dose for the average man through inhalation is as low as 60 milligrams, but may range from 100 to 150 milligrams on average. Hydrogen cyanide is a fast acting blood agent capable of killing exposed troops within minutes of dissemination. Personnel who inhale lethal concentrations over short periods of time will die within minutes. Slow exposure to lethal concentrations over long periods of time leads to paralysis, respiratory distress, nausea, and other incapacitating effects leading to death within 4 to 32 hours. Personnel slowly exposed to hydrogen cyanide over long periods of time should be treated with an anti cyanide antidote made by dissolving 1 gram of sodium nitrite, and 1 gram of sodium thiosulfate into 50 milliliters of water, and administering this antidote intravenously or through ingestion. Some people may be cyanide sensitive, meaning inhalation of as little as 300 parts per million over several minutes can lead to death. Skin absorption and ingestion of hydrogen cyanide is highly toxic, but few casualties result in this manner due to its volatility.**

OVERALL RATING (scale from 1 to 10)	
<i>Effectiveness (as blood agent):</i> 10	<i>Field Stability:</i> 10
<i>Persistence (open area):</i> 2	<i>Storage stability:</i> 8
<i>Persistence (enclosed area):</i> 9	<i>Toxicity (as blood agent):</i> 10
<b>TOTAL EFFECTIVENESS (as blood agent): 8.1</b>	
<b>OVERALL TOXICITY (as warfare agent): 7½</b>	

### Procedure 2-001A: Preparation of Hydrogen cyanide (cyanide process)

**Summary:** Hydrogen cyanide is readily prepared by reacting sodium or potassium cyanide with diluted sulfuric acid. The reaction takes place at a heated temperature to provoke volatilization of the hydrogen cyanide, which then distills over. The desired product is then redistilled to obtain high purity hydrogen cyanide.



Chapter 6: The Preparation of blood agents  
*Reaction Equation (by products omitted)*

<b>Materials:</b>	1. 79 grams of sodium cyanide	3. 158 grams of 98% sulfuric acid
	2. 104 grams of potassium cyanide	

**Hazards:**



Do not attempt in anyway to prepare hydrogen cyanide using the following procedure unless proper safety precautions are taken. 1) Perform all operations in a clean box, in which is completely sealed from the air. Note: A clean box in this case is not needed. Hydrogen cyanide can be safely prepared as long as the maker wears proper gas mask, and nitrile gloves. 2) After each procedure, all glassware and non-electric equipment should be soaked in an alkali lye solution before removing from the clean box, and/or before rinsing and storing. Any electrical equipment that may be contaminated (even if suspected), such as hot plates and stirring equipment should be carefully wiped down with a rag soaked in alkali lye solution, followed by wiping down with hot water. Spills can be neutralized by the addition of baking soda. 3) The desired hydrogen cyanide product should be stored in amber bottles, preferably non-breakable containers, and stored in a refrigerator away from sunlight. The bottles should also be placed inside an airtight sealed plastic bag, such as a 'ziplock' bag. 4) Storage of this blood agent should be in airtight refrigerators, and said storage spaces should be equipped with chemical agent detection monitors to alert of any potential leakage.

Use care when handling sodium or potassium cyanide, which is highly poisonous, and can be absorbed through the skin. Use caution when handling concentrated sulfuric acid.

**Procedure:** Assemble the apparatus in figure 031, and then place 79 grams of sodium cyanide or 104 grams of potassium cyanide into the reaction flask, and then add 100 milliliters of water. Thereafter, prepare a sulfuric acid solution by carefully adding 185 grams of 98% sulfuric acid into 200 milliliters of cold water, and then allow the acid solution to cool to room temperature. Then place the acid solution into the addition funnel. Then heat the reaction flask to 60 Celsius, and when the temperature reaches 60 Celsius, add drop wise the sulfuric acid solution to the cyanide solution while stirring the cyanide solution. During the addition, keep the addition of the sulfuric acid at a sufficient rate as to not exceed a temperature of 60 Celsius. During the addition, hydrogen cyanide will be steadily evolved, and will slowly distill over. After the addition of the sulfuric acid, continue to heat and distill the reaction mixture for 4 hours. After 4 hours, remove the heat source and allow the reaction mixture to cool to room temperature. Note: The reaction mixture should be disposed of properly as it will contain small amounts of hydrogen cyanide and metal cyanide; see local E.P.A restrictions regarding proper disposal of hydrogen cyanide-containing water solutions; under most conditions, hydrogen cyanide water solutions should be treated with baking soda to neutralize the cyanide acid, followed by disposing through a drain or sink, followed by flushing with large amounts of cold water. The distilled hydrogen cyanide should be redistilled for quality and purity.

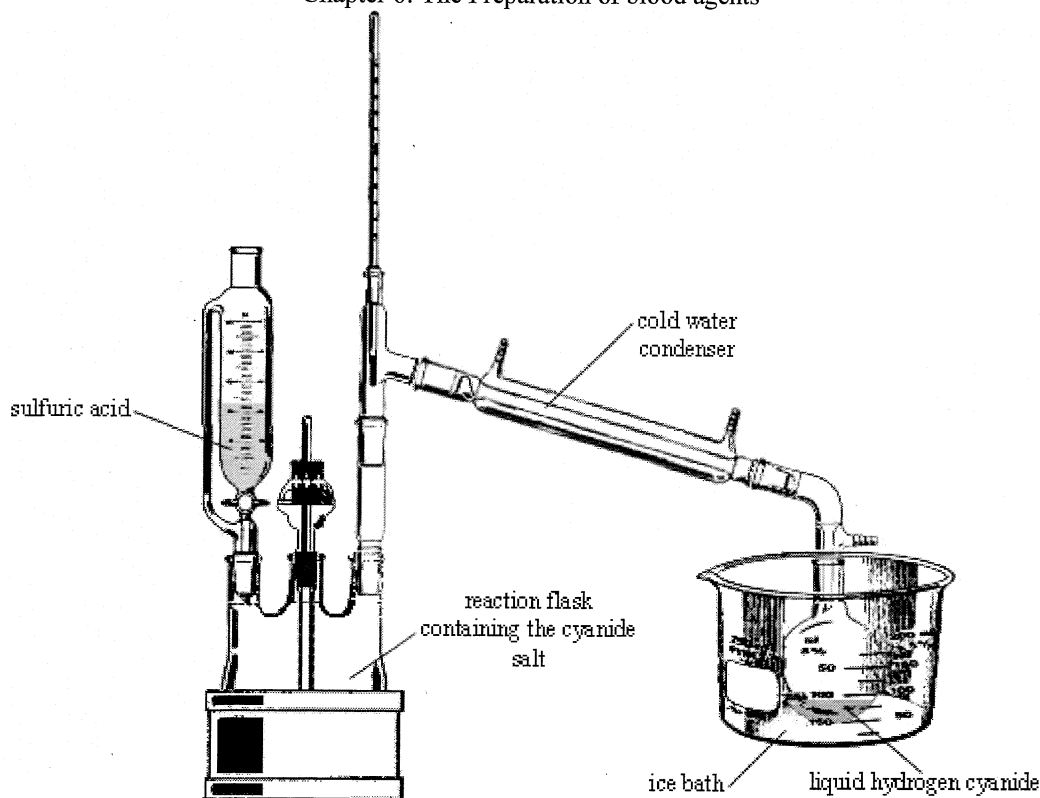
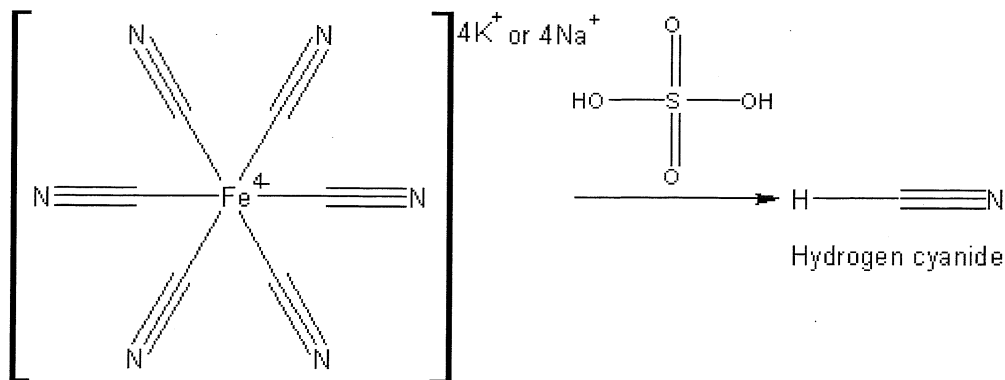


Figure 031. Apparatus for the preparation of hydrogen cyanide. The hydrogen cyanide should be redistilled using a similar apparatus minus the addition funnel and electric stirrer.

**Procedure 2-001B: Preparation of Hydrogen cyanide (ferrocyanide process)**

**Summary:** Hydrogen cyanide is readily prepared by reacting sodium or potassium ferrocyanide with diluted sulfuric acid. The reaction takes place at a heated temperature to provoke volatilization of the hydrogen cyanide, which then distills over. The desired product is then redistilled to obtain high purity hydrogen cyanide.



*Reaction Equation (by products omitted)*

<b>Materials:</b>	1. 47 grams of potassium ferrocyanide	3. 75 grams of 98% sulfuric acid
	2. 38 grams of sodium ferrocyanide	

**Hazards:**

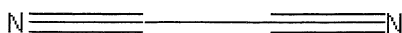


Do not attempt in anyway to prepare hydrogen cyanide using the following procedure unless proper safety precautions are taken. 1) Perform all operations in a clean box, in which is completely sealed from the air. Note: A clean box in this case is not needed. Hydrogen cyanide can be safely prepared as long as the maker wears proper gas mask, and nitrile gloves. 2) After each procedure, all glassware and non-electric equipment should be soaked in a alkali lye solution before removing from the clean box, and/or before rinsing and storing. Any electrical equipment that may be contaminated (even if suspected), such as hot plates and stirring equipment should be carefully wiped down with a rag soaked in alkali lye solution, followed by wiping down with hot water. 3) The desired hydrogen cyanide product should be stored in amber bottles, preferably non-breakable containers, and stored in a refrigerator away from sunlight. The bottles should also be placed inside an airtight sealed plastic bag, such as a 'ziplock' bag. 4) Storage of this blood agent should be in airtight refrigerators, and said storage spaces should be equipped with chemical agent detection monitors to alert of any potential leakage.

Use caution when handling concentrated sulfuric acid.

**Procedure:** Assemble the apparatus in figure 031 (see 2-001A), and then place 47 grams of potassium ferrocyanide or 38 grams of sodium ferrocyanide into the reaction flask, and then add 50 milliliters of water. Thereafter, prepare a sulfuric acid solution by carefully adding 75 grams of 98% sulfuric acid into 100 milliliters of cold water, and then allow the acid solution to cool to room temperature. Then place the acid solution into the addition funnel. Then heat the reaction flask to 60 Celsius, and when the temperature reaches 60 Celsius, add drop wise the sulfuric acid solution to the ferrocyanide solution while stirring the ferrocyanide solution. During the addition, keep the addition of the sulfuric acid at a sufficient rate as to not exceed a temperature of 60 Celsius. During the addition, hydrogen cyanide will be steadily evolved, and slowly distilled over. After the addition of the sulfuric acid continue to heat and distill the reaction mixture for 4 hours. After 4 hours, remove the heat source and allow the reaction mixture to cool to room temperature. Note: The reaction mixture should be disposed of properly as it will contain small amounts of hydrogen cyanide; see local E.P.A restrictions regarding proper disposal of hydrogen cyanide-containing water solutions; under most conditions, hydrogen cyanide water solutions can be neutralized with baking soda, and then disposed of through a drain or sink, followed by flushing with large amounts of cold water. The distilled hydrogen cyanide should be redistilled for quality and purity.

## 02-002. CA. Cyanogen. *Ethanedinitrile; dicyan; oxalic acid dinitrile; Dicyanide*



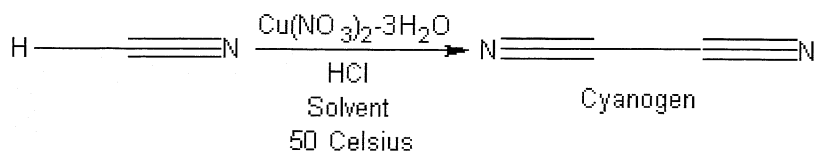
CA

Cyanogen forms a colorless gas with a melting point of  $-28$  Celsius, and a boiling point of  $-21$  Celsius. The gas is flammable, burning with a pinkish flame having a blue border. It has a rather biting and irritating odor with a hint of almonds, but in some cases the gas may be odorless. Low concentrations of the gas have an almond like odor. The gas in lethal concentrations has an acrid and pungent odor. The gas polymerizes when heated to 500 Celsius forming paracyanogen. Cyanogen is modernly soluble in water, from where it is slowly hydrolyzed to ammonia and oxalic acid. The gas is soluble in alcohol and ether. The toxic effects of cyanogen are similar to hydrogen cyanide, and it can be used admixed with hydrogen cyanide, or alone in military operations where a strong blood agent is desired. Like hydrogen cyanide, cyanogen is most effective when used in enclosed areas, and it has little or no persistence in the environment. Cyanogen is extremely effective when used in enclosed environments, and it can persist for weeks; buildings and rooms with ventilation are prone to rapid decontamination due to air sweeping the cyanogen gas away. Cyanogen is most effective when used in bunkers, tunnels, and rooms where there is poor ventilation. Cyanogen should be disseminated using aerosols. **Cyanogen chloride is a deadly blood agent capable of producing casualties within minutes of dissemination. Lethal dose through inhalation may range from 100 to 150 milligrams; although, as low as 60 milligrams may lead to death in certain people due to allergic like reactions. Inhalation of 900 parts per million over a period of ten minutes may lead to death in some cases. Chronic exposure to low concentrations of the agent may lead to respiratory illness, and systematic poisoning leading to death after prolonged periods of time. Exposure to lethal concentrations is easily fatal within minutes. Symptoms of cyanogen poisoning are similar to hydrogen cyanide. Skin exposure to vapor or liquid may cause systematic poisoning, but rather high levels are ordinarily required.**

OVERALL RATING (scale from 1 to 10)	
<i>Effectiveness (as blood agent):</i> 9	<i>Field Stability:</i> 8
<i>Persistence (open area):</i> 2	<i>Storage stability:</i> 7
<i>Persistence (enclosed area):</i> 9	<i>Toxicity (as blood agent):</i> 9
TOTAL EFFECTIVENESS (as blood agent): 7.3	
OVERALL TOXICITY (as warfare agent): 7	

### Procedure 2-002A: Preparation of Cyanogen (hydrogen cyanide process)

**Summary:** Cyanogen is conveniently prepared by simply adding liquid hydrogen cyanide to a solution of cupric nitrate and hydrochloric acid. In this case, dimethoxy ethane is used as the solvent, and the cupric nitrate is the catalyst. Hydrochloric acid is added to maintain a proper pH level. During the reaction, the cyanogen is continuously formed, and removed by an oxygen gas stream. The cyanogen is separated from unreacted hydrogen cyanide, and then condensed using appropriate cooling. Note: The preparation of cyanogen discussed in this procedure is similar or related to the process discussed in application number 583,516 June 4<sup>th</sup>, 1975 by Wilhelm Riemenschneider, Frankfurt Germany, and Peter Wegener, Schneidhain Germany; assigned to Hoechst Aktiengesellschaft. This process may be protected by industrial/commercial process applications. Consult said application number before using the mentioned process for commercial or industrial purposes.



*Reaction Equation (by products omitted)*

Materials:	1. 400 milliliters of dimethoxy ethane	3. 68 grams of liquid hydrogen cyanide
	2. 10 grams of cupric nitrate trihydrate	

#### Hazards:



Do not attempt in anyway to prepare cyanogen using the following procedure unless proper safety precautions are taken. 1) Perform all operations in a clean box, in which is completely sealed from the air. Note: A clean box in this case is not needed. Cyanogen can be safely prepared as long as the maker wears proper gas mask, and nitrile gloves. 2) After each procedure, all glassware and non-electric equipment should be soaked in a hot alkali lye solution before removing from the clean box, and/or before rinsing and storing. Any electrical equipment that may be contaminated (even if suspected), such as hot plates and stirring equipment should be carefully wiped down with a rag soaked in a hot alkali lye solution, followed by wiping down with hot water. 3) The desired cyanogen product should be stored in amber bottles, preferably non-breakable containers, and stored in a freezer away from sunlight. The bottle should also be placed inside an airtight sealed plastic bag, such as a 'ziplock' bag. 4) Storage of this blood agent should be in airtight freezers, and said storage spaces should be equipped with chemical agent detection monitors to alert of any potential leakage.

Use extreme care when handling liquid hydrogen cyanide (see vide supra). Extinguish all flames before using dimethoxy ethane, which is highly flammable. Cupric nitrate is a strong oxidizing agent; keep out of contact with combustible materials. Hydrochloric acid is very corrosive, use care when handing.

**Procedure:** Assemble the apparatus in figure 032, and then place 400 milliliters of dimethoxy ethane, 10 grams of cupric nitrate trihydrate, and 8 milliliters of 35 to 38% hydrochloric acid into the reaction flask. Thereafter, place 68 grams of liquid hydrogen cyanide into the addition funnel. Then begin an oxygen purge by bubbling oxygen gas into the dimethoxy ethane contained in the reaction flask. Note: an oil bubbler is not needed to exclude air. Then heat the reaction flask to 50 Celsius, and when its temperature reaches 50 Celsius, add drop wise the liquid hydrogen cyanide over a period of 90 minutes while stirring the reaction mixture and maintaining its temperature at 50 Celsius. During the addition of the hydrogen cyanide, cyanogen and unreacted hydrogen cyanide

will be carried over to the first ice trap. The unreacted hydrogen cyanide will be condensed into liquid hydrogen cyanide using the ice bath, and the cyanogen will carry over to the second trap cooled with a dry ice/acetone bath, where upon the cyanogen will condense into a semi-solid liquid mass or slush. After the addition of the liquid hydrogen cyanide, remove the heat source, and allow the reaction mixture to cool to room temperature; after which, it can be discarded. The cyanogen collected will be about 60 grams with a purity of 98%+. Purification of this Cyanogen slush is not needed, and it should be immediately removed, and stored in a freezer until use. Note: the cyanogen can be stored in individual self purchased lecture bottles for long periods of storage.

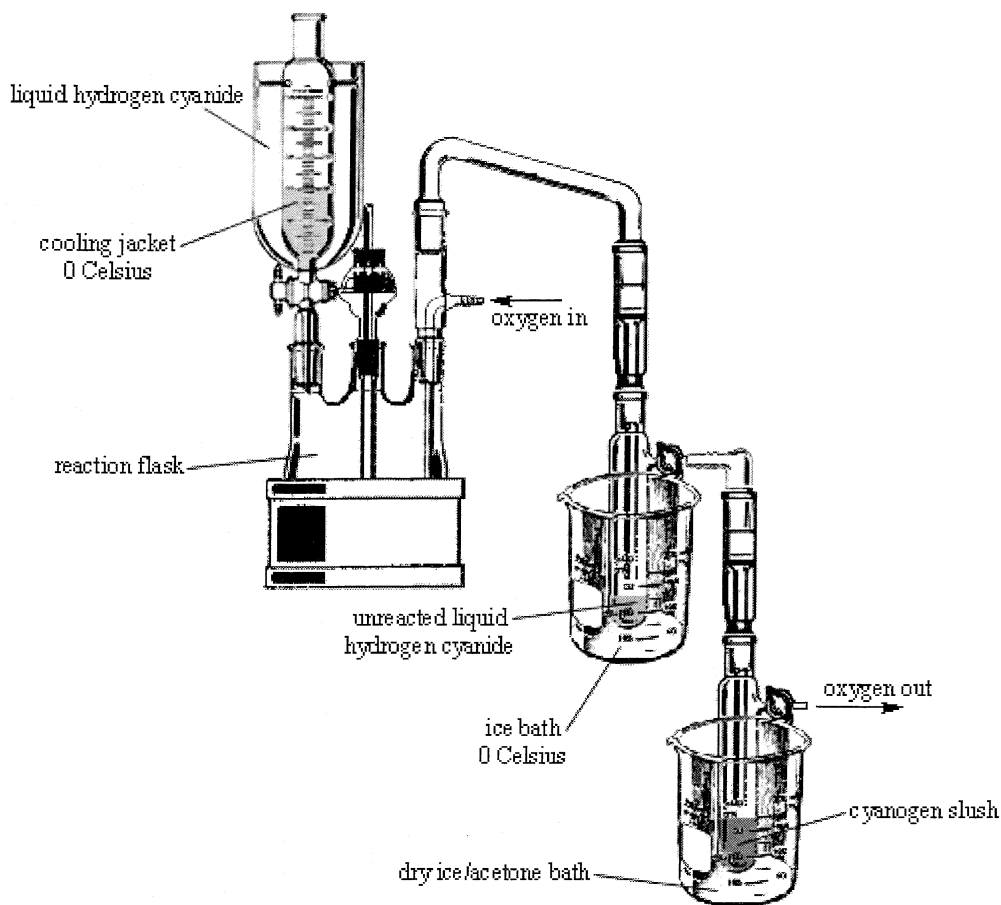
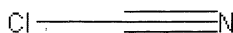


Figure 032. Apparatus for cyanogen preparation.

### 02-003. CK. Cyanogen chloride. *Chlorine cyanide*



CK

Cyanogen chloride forms a colorless gas, which condenses to a colorless liquid. It has a melting point of  $-6$  Celsius, and a boiling point of  $14$  Celsius. The gas has a pungent and biting odor, but it may go unnoticed in field concentrations. Cyanogen chloride is soluble in water, alcohol, ether, and chlorinated hydrocarbons. Cyanogen chloride is a deadly poison, which is very irritating to the nose, throat, and eyes. High concentrations easily give rise to its presence, and irritation to eyes, nose, and throat is almost immediate upon exposure to the gas. Inhalation of high concentrations is easily fatal within 15 minutes of exposure. Exposure to low concentrations over long periods of time may lead to systematic poisoning resulting in permanent illness such as respiratory illness, kidney and liver damage. As with hydrogen cyanide, or cyanogen, cyanogen chloride is highly volatile, and its persistence in the environment is very poor. It is easily swept away with the slightest breeze, and should only be used within enclosed areas such as bunkers, tunnels, and/or rooms with poor ventilation. Cyanogen chloride should be disseminated from aerosols for maximum dissemination effect. Cyanogen chloride can be effectively used not only as a deadly blood agent, but it may be used as a violent riot control or violent irritant gas. Cyanogen chloride is a violent and deadly blood agent capable of producing casualties within minutes of dissemination. The lethal dose through inhalation in the average man ranges from 80 to 150 milligrams, but may be as high as 500 milligrams. The lethal dose for a select few may be as high as 600 to 800 milligrams through inhalation due to higher levels of resistance to the deadly gas. Lethal dose through contact in rabbits: 20 milligrams per kilogram of body weight. Inhalation

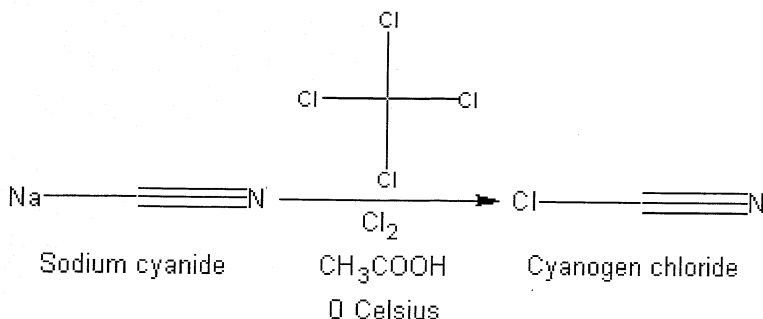


of as little as 5 milligrams may result in respiratory illness, and severe irritation to the nose and throat. Eye exposure to as little as 5 to 10 milligrams may produce irritation. Skin contact to the vapor or liquid may lead to irritation. Inhalation of 900 to 1200 parts per million of cyanogen chloride over a period of 5 to 10 minutes may be fatal.

OVERALL RATING (scale from 1 to 10)	
<i>Effectiveness (as blood agent):</i> 8	<i>Field Stability:</i> 9
<i>Persistence (open area):</i> 3	<i>Storage stability:</i> 9
<i>Persistence (enclosed area):</i> 9	<i>Toxicity (as blood agent):</i> 8
<b>TOTAL EFFECTIVENESS (as blood agent):</b> 7.6	
<b>OVERALL TOXICITY (as warfare agent):</b> 6½	

### Procedure 2-003A: Preparation of Cyanogen Chloride (chlorine process)

**Summary:** Cyanogen chloride is readily prepared by reacting chlorine gas with a solution of sodium cyanide, in the presence of glacial acetic acid. Carbon tetrachloride comprises the solvent, and the glacial acetic acid is added as a promoter. The reaction is kept at 0 Celsius at all times to avoid the possibility of side reactions, and/or violent reactions. After the addition of the chlorine gas, the reaction mixture is filtered to remove the precipitated sodium chloride, and the resulting reaction mixture is then carefully distilled to remove the volatile cyanogen chloride, which is collected in an ice/salt trap. Note: The preparation of cyanogen chloride discussed in this procedure is similar or related to the process discussed in serial number 175,419, March 14<sup>th</sup>, 1927 by Paul Dieterle of Buffalo, NY; assigned by National Aniline & Chemical Company, Inc. This process may be protected by industrial/commercial process applications. Consult said application number before using the mentioned process for commercial or industrial purposes.



*Reaction Equation (by products omitted)*

<b>Materials:</b>	1. 100 grams of pulverized sodium cyanide	3. 140 grams of dry chlorine gas
	2. 4 grams of glacial acetic acid	4. 600 grams of carbon tetrachloride

**Hazards:**



Do not attempt in anyway to prepare cyanogen chloride using the following procedure unless proper safety precautions are taken. 1) Perform all operations in a clean box, in which is completely sealed from the air. Note: A clean box in this case is not needed. Cyanogen chloride can be safely prepared as long as the maker wears proper gas mask, and nitrile gloves. 2) After each procedure, all glassware and non-electric equipment should be soaked in a hot alkali lye solution before removing from the clean box, and/or before rinsing and storing. Any electrical equipment that may be contaminated (even if suspected), such as hot plates and stirring equipment should be carefully wiped down with a rag soaked in a hot alkali lye solution, followed by wiping down with hot water. 3) The desired cyanogen chloride product should be stored in amber bottles, preferably non-breakable containers, and stored in a very cold refrigerator away from sunlight. The bottles should also be placed inside an airtight sealed plastic bag, such as a 'ziplock' bag. 4) Storage of this blood agent should be in airtight very cold refrigerators, and said storage spaces

## Chapter 6: The Preparation of blood agents

should be equipped with chemical agent detection monitors to alert of any potential leakage.

Use caution when handling sodium cyanide, which can be absorbed through the skin leading to systematic poisoning.

Use care when handling chlorine gas, which is toxic, and causes choking. Use care when handling carbon tetrachloride, which is toxic, and may accumulate in the body leading to systematic poisoning effects.

**Procedure:** Into a suitable flask equipped with a thermometer, electric stirrer, and gas inlet tube, place 600 grams of carbon tetrachloride, 4 grams of glacial acetic acid, and then 100 grams of dry pulverized sodium cyanide. Thereafter, place the flask into a suitable ice bath, and chill to 0 Celsius. When the contents in the flask reach about 0 Celsius, bubble into the carbon tetrachloride, 140 grams of dry chlorine gas over a period of time sufficient as to keep the reaction mixtures temperature at 0 Celsius at all times. Note: do not allow the temperature of the reaction mixture to exceed 0 Celsius. During the addition of the chlorine gas, vigorously stir the reaction mixture. After the addition of the chlorine gas, continue to vigorously stir the reaction mixture at 0 Celsius for about 1 hour. Note: Excess chlorine addition beyond 140 grams should be avoided. After stirring for an additional 60 minutes, remove the ice bath, and then filter the reaction mixture to remove any insoluble materials. Thereafter, place the filtered reaction mixture into a distillation apparatus as illustrated in figure 033, and then carefully distill-out the cyanogen chloride. After the distillation process, the cyanogen chloride should be re-distilled for purity. Note: the cyanogen chloride obtained after the first distillation can be used directly in chemical warfare operations. Note: After the reaction mixture is filtered to remove the insoluble materials, the carbon tetrachloride/cyanogen chloride mixture can be used directly in chemical warfare operations if desired. Note: The cyanogen chloride should be stored in amber glass bottles and in a very cold refrigerator until use.

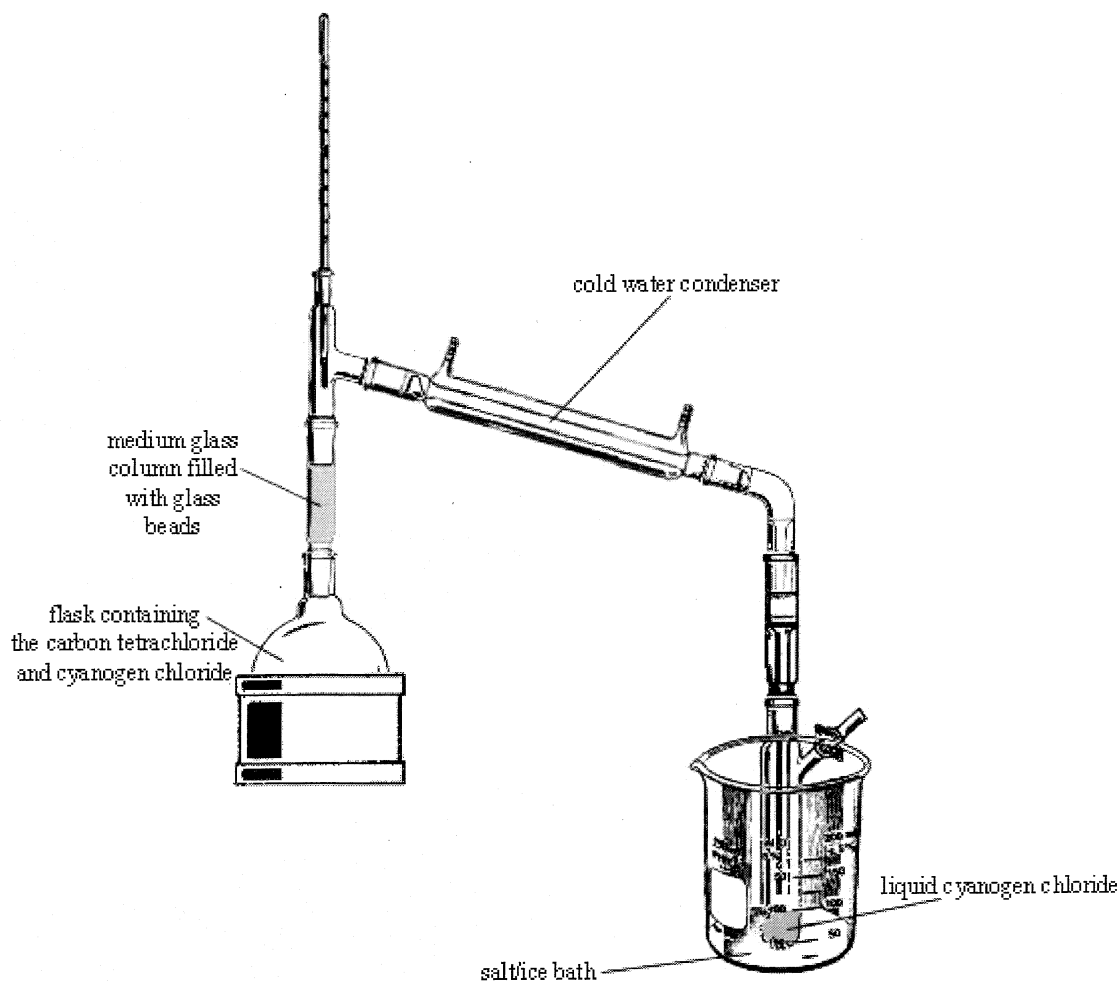


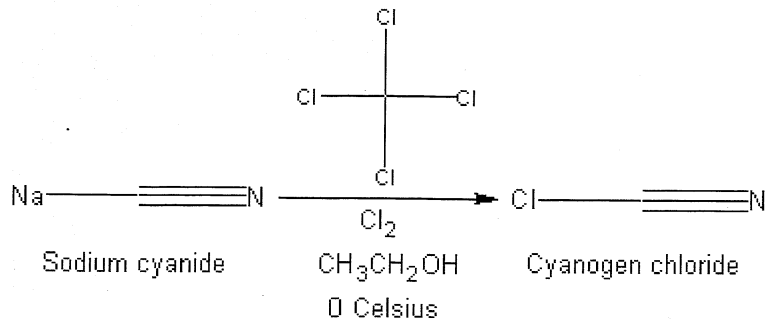
Figure 033. Distillation apparatus for the distillation of cyanogen chloride. The mixture should be carefully distilled at 40 to 60 Celsius.

### Procedure 2-003B: Preparation of Cyanogen Chloride (modified chlorine process)

**Summary:** Cyanogen chloride is readily prepared by reacting chlorine gas with a solution of sodium cyanide, in the presence of 95% ethyl alcohol. Carbon tetrachloride comprises the solvent, and the 95% ethyl alcohol is added as a promoter. The reaction is kept at 0 Celsius at all times to avoid the possibility of side reactions, and/or violent reactions. After the addition of the chlorine gas, the

Chapter 6: The Preparation of blood agents

reaction mixture is filtered to remove the precipitated sodium chloride, and the resulting reaction mixture is then carefully distilled to remove the volatile cyanogen chloride, which is collected in an ice/salt trap. Note: The preparation of cyanogen chloride discussed in this procedure is similar or related to the process discussed in serial number 163,565, January 25<sup>th</sup>, 1927, by Johann Paul Schmittngel, of Basel Switzerland; assigned to National Aniline & Chemical Company, Inc. This process may be protected by industrial/commercial process applications. Consult said application number before using the mentioned process for commercial or industrial purposes.



*Reaction Equation (by products omitted)*

<b>Materials:</b>	1. 100 grams of pulverized sodium cyanide	3. 1 grams of 95% ethyl alcohol
	2. 600 grams of carbon tetrachloride	4. 140 grams of dry chlorine gas

**Hazards:**



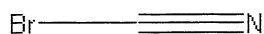
Do not attempt in anyway to prepare cyanogen chloride using the following procedure unless proper safety precautions are taken. 1) Perform all operations in a clean box, in which is completely sealed from the air. Note: A clean box in this case is not needed. Cyanogen chloride can be safely prepared as long as the maker wears proper gas mask, and nitrile gloves. 2) After each procedure, all glassware and non-electric equipment should be soaked in a hot alkali lye solution before removing from the clean box, and/or before rinsing and storing. Any electrical equipment that may be contaminated (even if suspected), such as hot plates and stirring equipment should be carefully wiped down with a rag soaked in a hot alkali lye solution, followed by wiping down with hot water. 3) The desired cyanogen chloride product should be stored in amber bottles, preferably non-breakable containers, and stored in a very cold refrigerator away from sunlight. The bottles should also be placed inside an airtight sealed plastic bag, such as a 'ziplock' bag. 4) Storage of this blood agent should be in airtight very cold refrigerators, and said storage spaces should be equipped with chemical agent detection monitors to alert of any potential leakage.

Use caution when handling sodium cyanide, which can be absorbed through the skin leading to systematic poisoning. Use care when handling chlorine gas, which is toxic, and causes choking. Use care when handling carbon tetrachloride, which is toxic, and may accumulate in the body leading to systematic poisoning effects.

**Procedure:** Into a suitable flask equipped with a thermometer, electric stirrer, and gas inlet tube, place 600 grams of carbon tetrachloride, 1 gram of 95% ethanol, and then 100 grams of dry pulverized sodium cyanide. Thereafter, place the flask into a suitable ice bath, and chill to 0 Celsius. When the contents in the flask reach about 0 Celsius, bubble into the carbon tetrachloride, 140 grams of dry chlorine gas over a period of time sufficient as to keep the reaction mixtures temperature at 0 Celsius at all times. Note: do not allow the temperature of the reaction mixture to exceed 0 Celsius. During the addition of the chlorine gas, vigorously stir the reaction mixture. After the addition of the chlorine gas, continue to vigorously stir the reaction mixture at 0 Celsius for about 1 hour. Note: Excess chlorine addition beyond 140 grams should be avoided. After stiring for an additional 60 minutes, remove the ice bath, and then filter the reaction mixture to removes any insoluble materials. Thereafter, place the filtered reaction mixture into a distillation apparatus as illustrated in figure 033 (see 2-003A), and then carefully distill-out the cyanogen chloride. After the distillation process, the cyanogen chloride should be re-distilled for purity. Note: the cyanogen chloride obtained after the first distillation can be used directly in chemical warfare operations. Note: After the reaction mixture is filtered to remove the insoluble materials, the carbon

tetrachloride/cyanogen chloride mixture can be used directly in chemical warfare operations if desired. Note: The cyanogen chloride should be stored in amber glass bottles and in a very cold refrigerator until use.

## 02-004. BC. Cyanogen bromide. *Bromine cyanide*



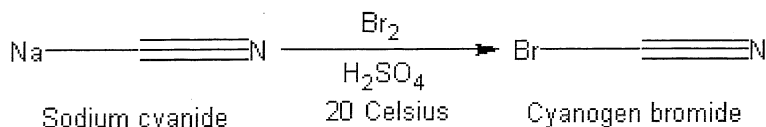
BC

Cyanogen bromide forms colorless crystals with a melting point of 52 Celsius, and a boiling point of 62 Celsius. The crystals are often needle or cubed shaped. Cyanogen bromide is freely soluble in water, alcohol, and ether. Pure cyanogen bromide is stable for periods of up to 2 months, but impure cyanogen bromide tends to decompose on standing, and in some cases it decomposes explosively. It should be stored in a desiccator in a refrigerator. At room temperature, solutions of cyanogen bromide in alcohol or ether may last for up to 3 months in storage. Cyanogen bromide is volatile under normal conditions, and the dry crystals tend to volatilize on standing. It is a highly irritating and toxic substance, capable of producing severe irritation of the nose, throat, and eyes upon contact. Because of cyanogen bromides rate of volatilization, and its rather rapid rate of decomposition, its use in military operations is very limited. It can be used in tactical operations when disseminated properly, and the most preferred methods of dissemination are from aerosols. As with other blood agents, it's persistence in the environment is very poor, but it does show some persistence compared to hydrogen cyanide. Crystals of cyanogen bromide may persist for up to 2 weeks, or even as high as 1 month in dry and cold environments. Skin contact or eye contact with the vapor or liquid may cause immediate irritation and a prickling like effect. Inhalation of the vapor is easily fatal within 5 to 10 minutes when in lethal concentrations. Skin or eye exposure can lead to systematic poisoning in large concentrations, but even small concentrations may give rise to significant skin and eye absorption leading to systematic poisoning. Cyanogen bromide is highly effective when used in enclosed environments. **Cyanogen bromide is a highly effective blood agent, and is capable of producing casualties within minutes of dissemination. The lethal dose through inhalation in the average man ranges from 60 to 200 milligrams. Some people may show increased levels of resistance making the lethal dose though inhalation rise to as high as 500 milligrams. Skin contact or eye contact with as little as 5 to 15 milligrams of the vapor may produce immediate, and severe irritation. Skin or eye absorption of as little as 5 to 10 milligrams can lead to systematic poisoning resulting in repository illness, kidney, or liver damage.**

OVERALL RATING (scale from 1 to 10)	
<i>Effectiveness (as blood agent):</i> 9	<i>Field Stability:</i> 5
<i>Persistence (open area):</i> 5	<i>Storage stability:</i> 6
<i>Persistence (enclosed area):</i> 8	<i>Toxicity (as blood agent):</i> 8
<b>TOTAL EFFECTIVENESS (as blood agent): 6.8</b>	
<b>OVERALL TOXICITY (as warfare agent): 7</b>	

### Procedure 2-004A: Preparation of Cyanogen Bromide

**Summary:** Cyanogen bromide is easily prepared by reacting bromine with sodium cyanide in the presence of sulfuric acid. The sulfuric acid prevents unwanted side reactions, and decomposition of the cyanogen bromide. After the reaction, some of the cyanogen bromide can be collected by filtration, followed by drying in a desiccator for 24 hours or until dry. The reaction mixture will contain the remaining cyanogen chloride, from which it can be recovered by distillation. During the distillation, the cyanogen bromide condenses on the inner walls of the cold-water condenser. From there it can be recovered by gently heating the condenser to melt it, and then collecting the liquid into a beaker or flask. The cyanogen bromide should be used within 2 months of preparation. Note: The preparation of cyanogen bromide discussed in this procedure is similar or related to the process discussed in serial number 697,956, September 19<sup>th</sup>, 1946, by Raymond H. Hartigan of Pittsburgh, PA; assigned to Koppers Company, Inc. This process may be protected by industrial/commercial process applications. Consult said application number before using the mentioned process for commercial or industrial purposes.



*Reaction Equation (by products omitted)*

<b>Materials:</b>	1. 75 milliliters of 50% of sulfuric acid	3. 26 grams of sodium cyanide
	2. 80 grams of bromine	

**Hazards:**

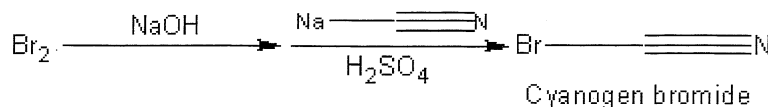
Do not attempt in anyway to prepare cyanogen bromide using the following procedure unless proper safety precautions are taken. 1) Perform all operations in a clean box, in which is completely sealed from the air. Note: A clean box in this case is not needed. Cyanogen bromide can be safely prepared as long as the maker wears proper gas mask, and nitrile gloves. 2) After each procedure, all glassware and non-electric equipment should be soaked in a hot alkali lye solution before removing from the clean box, and/or before rinsing and storing. Any electrical equipment that may be contaminated (even if suspected), such as hot plates and stirring equipment should be carefully wiped down with a rag soaked in a hot alkali lye solution, followed by wiping down with hot water. 3) The desired cyanogen bromide product should be stored in amber bottles, preferably non-breakable containers, and stored in a refrigerator away from sunlight. The bottles should also be placed inside an airtight sealed plastic bag, such as a 'ziplock' bag. 4) Storage of this blood agent should be in airtight refrigerators, and said storage spaces should be equipped with chemical agent detection monitors to alert of any potential leakage.

Use caution when handling sodium cyanide, which can be absorbed through the skin leading to systematic poisoning. Use care when handling bromine, which is toxic, and causes severe irritation.

**Procedure:** Into a suitable flask, place 75 milliliters of 50% sulfuric acid, and then cool this acid solution to 20 Celsius by means of a cold water bath. Thereafter, pour in 80 grams of bromine to the sulfuric acid solution, while keeping the temperature of the sulfuric acid at 20 Celsius. Then carefully and slowly add a cyanide solution prepared by adding and dissolving 26 grams of sodium cyanide into 50 milliliters of cold water. The rate of addition of the sodium cyanide solution should be adequate as not to exceed a temperature of 20 Celsius of the sulfuric acid/bromine solution. During the addition of the sodium cyanide solution, vigorously stir the sulfuric acid/bromine mixture. After the addition of the sodium cyanide solution, place the reaction mixture into an ice bath and chill to 0 Celsius. Then stir the reaction mixture at 0 Celsius for about 1 hour. Thereafter, filter-off any precipitated cyanogen bromide crystals, and then carefully dry them in a desiccator filled with anhydrous calcium chloride for 24 hours, or until dry. Note: The filtered reaction mixture will contain some more of the cyanogen bromide, which will be dissolved there into. To collect this cyanogen bromide from the filtered reaction mixture, carefully distill the filtered reaction mixture at 62 Celsius. Use a glass column filled with anhydrous calcium chloride to remove any water vapor that may carry over with cyanogen bromide. The collected cyanogen bromide should then be added to the other cyanogen bromide stored in a desiccator. The cyanogen bromide should be stored in a desiccator filled with anhydrous calcium chloride, and stored in a refrigerator until use. This cyanogen bromide should be used within 2 months of preparation.

### Procedure 2-004B: Preparation of Cyanogen Bromide

**Summary:** Cyanogen bromide is easily prepared by reacting sodium bromate, and sodium bromide with sodium cyanide in the presence of dilute sulfuric acid. The sodium bromate and bromide are prepared on site by the addition of bromine to a solution of sodium hydroxide. The sulfuric acid helps promote the reaction. After the reaction, the cyanogen bromide is easily collected by distillation, from where it condenses onto the walls of the cold-water condenser during the distillation; where it is recovered by gently heating the cold-water condenser, and collecting the molten solid into a beaker. The resulting cyanogen bromide is then dried in a desiccator for 24 hours or until dry. Note: The preparation of cyanogen bromide discussed in this procedure is similar or related to the process discussed in serial number 30,138 September 15<sup>th</sup>, 1900, by Carl Goepner and Wilhelm Witter, both of Hamburg, Germany; assigned to (unofficially) The Empire of Germany (1901). This process may be protected by industrial/commercial process applications. Consult said application number before using the mentioned process for commercial or industrial purposes.



*Reaction Equation (by products omitted)*

<b>Materials:</b>	1. 120 grams of sodium hydroxide	3. 73.5 grams of pulverized sodium cyanide
-------------------	----------------------------------	--

2. 240 grams of bromine

4. 147 grams of 98% sulfuric acid

**Hazards:**

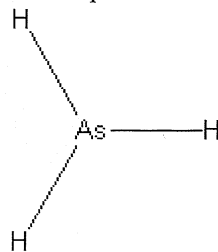
Do not attempt in anyway to prepare cyanogen bromide using the following procedure unless proper safety precautions are taken. 1) Perform all operations in a clean box, in which is completely sealed from the air. Note: A clean box in this case is not needed. Cyanogen bromide can be safely prepared as long as the maker wears proper gas mask, and nitrile gloves. 2) After each procedure, all glassware and non-electric equipment should be soaked in a hot alkali lye solution before removing from the clean box, and/or before rinsing and storing. Any electrical equipment that may be contaminated (even if suspected), such as hot plates and stirring equipment should be carefully wiped down with a rag soaked in a hot alkali lye solution, followed by wiping down with hot water. 3) The desired cyanogen bromide product should be stored in amber bottles, preferably non-breakable containers, and stored in a refrigerator away from sunlight. The bottles should also be placed inside an airtight sealed plastic bag, such as a 'ziplock' bag. 4) Storage of this blood agent should be in airtight refrigerators, and said storage spaces should be equipped with chemical agent detection monitors to alert of any potential leakage.

Use caution when handling sodium cyanide, which can be absorbed through the skin leading to systematic poisoning. Use care when handling bromine, which is toxic, and causes sever irritation. Use care when handling sodium hydroxide, which is capable of producing burns on the skin. Concentrated sulfuric acid is highly corrosive, use care when handling, and do not spill.

**Procedure:** Into a suitable flask, place 120 grams of sodium hydroxide, followed by 480 milliliters of water. Note: during the addition of the water, excessive heat will be generated. Then allow the sodium hydroxide solution to cool to room temperature. Then slowly and carefully add 240 grams of bromine to the sodium hydroxide solution. Note: During the addition, sodium bromide and sodium bromate will form; if any solids precipitate from the reaction mixture after the addition of the bromine, add enough water, with stirring, to dissolve them. After the bromine has been added, and the reaction mixture is a colorless solution with no precipitated solids, carefully add 73.5 grams of pulverized sodium cyanide over a sufficient time as to keep the reaction mixtures temperature at room temperature. During the addition, vigorously stir the reaction mixture. Immediately after the addition of the sodium cyanide, gently add a dilute sulfuric acid solution prepared by adding 147 grams of 98% sulfuric acid into 355 milliliters of water. Note: The addition of sulfuric acid to water results in the generation of much heat, allow this sulfuric acid solution to cool to room temperature before using; prepare this solution before starting the whole of this procedure. During the addition of the dilute sulfuric acid solution, vigorously stir the reaction mixture, and keep its temperature at room temperature. After the addition of the dilute sulfuric acid solution, stir the reaction mixture at room temperature for 30 minutes. Then place the entire reaction mixture into a common distillation apparatus, and carefully distill the reaction mixture at 62 Celsius to obtain cyanogen bromide crystals, which will be collected in the condenser of the distillation apparatus. Note: During the distillation of the reaction mixture, the cyanogen bromide will condense onto the surface of the inner tube of the cold-water condenser, where it will stick forming a pasty mass. After the distillation of the reaction mixture, the condenser should be removed, and then gently and quickly heated using a low flame from a Bunsen burner or the like, so the cyanogen bromide melts and it can then be collected into a beaker or flask. Note: in some cases, a small amount of the cyanogen bromide may distill all the way over into the receiver flask. After the cyanogen bromide has been recovered, place it into a desiccator filled with anhydrous calcium chloride, and allow it to dry for 24 hours, or until dry. The cyanogen bromide should be stored in a desiccator filled with anhydrous calcium chloride, and stored in a refrigerator until use. This cyanogen bromide should be used within 2 months of preparation.

### 02-005. *Arsine. Arsenic hydride; Hydrogen arsenide*

Chapter 6: The Preparation of blood agents



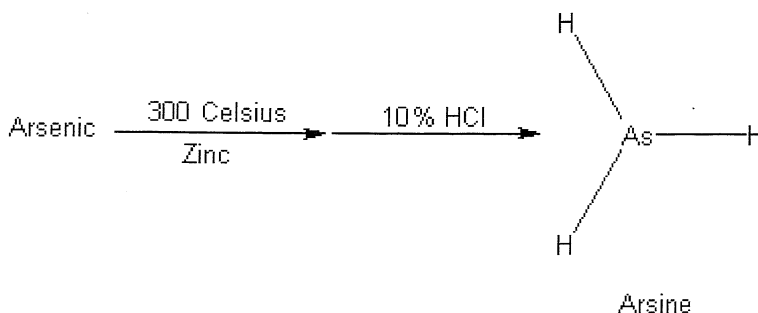
Arsine

Arsine is a colorless gas with a disagreeable garlic like odor. The gas is neither acidic nor basic, but it can form arsenides with various reactive metals. The gas has a melting point of  $-117$  Celsius, and a boiling point of  $-62$  Celsius. It is relatively stable under normal conditions, but it begins to decompose when heated to 300 Celsius. Moist arsine tends to decompose rather quickly when exposed to sunlight. Arsine is slightly soluble in water. It is a highly toxic gas, capable of causing death if inhaled. Chronic exposure to non-lethal amounts can lead to headaches, dyspnea, abdominal and back pain, nausea, and vomiting. Inhalation of lethal concentrations is easily fatal within minutes. Because of its tendency to decompose in moist environments within direct sunlight, and with its extremely low persistence in the environment, its use in military operations is limited. It has very poor persistence in the environment, even under extremely cold conditions. Arsine can be used effectively within enclosed environments such as bunkers, tunnels, rooms, buildings, and the like with lethal results. In open-air environments, the gas is easily swept away with the slightest breeze. Within enclosed environments such as rooms and tunnels with poor ventilation, the gas can persist for several days, to several weeks under dry and cool conditions. The persistence of arsine within enclosed areas is less than hydrogen cyanide. Although arsine shows less persistence and stability than most chemical warfare agents, it should not be underestimated or forgotten. Arsine is easily decomposed by strong oxidizers such as chlorine water, bleach, potassium permanganate solution, or bleaching powder. Skin exposure and eye exposure to the gas may cause delayed irritation. Arsine should be disseminated using aerosols. **Arsine is a fast acting blood agent capable of causing casualties within minutes of dissemination. The lethal dose through inhalation ranges from 40 to 120 milligrams per person. Lethal doses through inhalation may be as low 20 milligrams in certain people due to arsine generated allergic like reactions. Even though arsine has a disagreeable garlic odor, it may go unnoticed. Skin and eye exposure to as little as 5 milligrams may produce delayed irritation. Exposure to 500 to 1500 parts per minute over a period of 5 to 10 minutes may be fatal. Reports have shown that exposure to as little as 100 parts per minute over short periods of time can be fatal.**

OVERALL RATING (scale from 1 to 10)	
<i>Effectiveness (as blood agent): 9</i>	<i>Field Stability: 5</i>
<i>Persistence (open area): 3</i>	<i>Storage stability: 9</i>
<i>Persistence (enclosed area): 8</i>	<i>Toxicity (as blood agent): 9</i>
<b>TOTAL EFFECTIVENESS (as blood agent): 7.1</b>	
<b>OVERALL TOXICITY (as warfare agent): 7½</b>	

**Procedure 2-005A: Preparation of Arsine**

**Summary:** Arsine is readily prepared by reacting a zinc/arsenic alloy with dilute hydrochloric acid. During the reaction, arsine gas is steadily evolved, and is condensed into a liquid using a dry ice condenser or trap. The liquid arsine should then be immediately packaged into suitable pressure containers for use in aerosols munitions.



*Reaction Equation (by products omitted)*

<b>Materials:</b>	1. 31 grams of finely divided arsenic	3. 310 grams of 35 to 38% hydrochloric acid
	2. 40.5 grams of finely divided zinc	

**Hazards:**

Do not attempt in anyway to prepare arsine using the following procedure unless proper safety precautions are taken. 1) Perform all operations in a clean box, in which is completely sealed from the air. Note: A clean box in this case is not needed. Arsine can be safely prepared as long as the maker wears proper gas mask, and nitrile gloves. 2) After each procedure, all glassware and non-electric equipment should be soaked in bleach before removing from the clean box, and/or before rinsing and storing. Any electrical equipment that may be contaminated (even if suspected), such as hot plates and stirring equipment should be carefully wiped down with a rag soaked in bleach, followed by wiping down with hot water. 3) The desired arsine product should be immediately packaged into pressure vessels, such as lecture bottles or pressure containers for aerosol munitions. 4) The lecture bottles or pressure containers should be stored in airtight cabinets equipped with chemical agent detection monitors to alert of any potential leaks. Use caution when handling arsenic, which is a known carcinogen. Avoid skin contact or ingestion of arsenic, and avoid inhalation of dust. Finely divided zinc is flammable, so extinguish all flames before using. Concentrated hydrochloric acid is highly corrosive, and causes skin irritation.

**Procedure:** Into a quartz, nickel, or steel crucible, place 31 grams of finely divided arsenic, followed by 40.5 grams of finely divided zinc. Thereafter, carefully heat this mixture at 300 Celsius using a standard laboratory Bunsen burner, or oven for about 2 hours. Note: During the heating, the heat should not go above 300 Celsius. In some cases, some sublimation might take place. If during the heating process some sublimation takes place, reduce the heat immediately. After heating the mixture for about 2 hours at 300 Celsius, remove the heat source, and allow the contents in the crucible to cool to room temperature. Thereafter, place the contents of the crucible into a suitable flask, and assemble the apparatus illustrated in figure 034. Then gradually add, drop wise, 1100 grams of a dilute hydrochloric acid solution prepared by adding 310 grams of 35 to 38% hydrochloric acid into 790 grams of water. The addition of the dilute hydrochloric acid solution should not take very long, but should be added at such a rate as not to produce a violent gas evolution upon contact with the arsenic/zinc mixture contained in the flask. After the addition of the dilute hydrochloric acid solution, gently heat the reaction mixture at 40 to 60 Celsius with moderate stirring. Note: during the addition, and during the heating process, arsine gas will be steadily evolved. During the heating process, monitor the gas evolution from the reaction mixture carefully, so as to prevent a possible violent and rapid formation of arsine gas. If during the heating process, a rapid evolution of gas is evolved, physically remove the heat source from contact with the flask immediately. Heat and stir the reaction mixture at 40 to 60 Celsius for about 2 hours, or until no more gas is seen evolving from the reaction mixture (bubbling up). When no more gas is seen evolving from the reaction mixture, remove the heat source, and then discard the reaction mixture once its contents have cooled to room temperature. The liquid slushy arsine product obtained in the dry ice condenser should then be stored in self-purchased lecture bottles, or immediately placed into pressure containers for aerosol munitions.



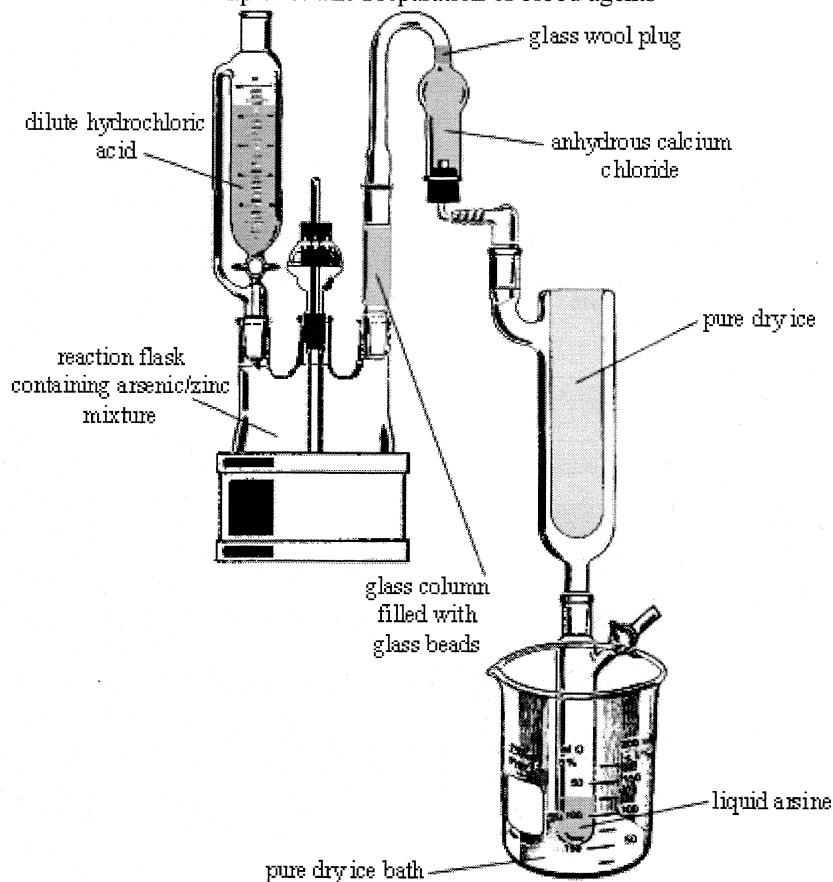
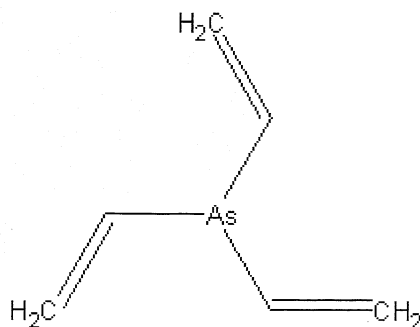


Figure 034. Apparatus for the preparation of arsine.

### 02-006. VS. Vinylarsine. *Trivinylarsenic; Tris(vinyl)arsine*



VS

Vinylarsine forms a colorless liquid, with a boiling point of 124 Celsius. The liquid and vapor have an irritating and biting odor, but in some cases the vapor may go unnoticed. Vinylarsine is stable, and can persist for a long time with proper storage. Impure vinylarsine may slowly polymerize on long standing. It is soluble in the usual organic solvents, and only slightly soluble in water. Water tends to slowly decompose vinylarsine, but only at very slow rates; alkalis speed up the process, and bleach completely destroys vinylarsine within minutes. Vinylarsine can act not only as a blood agent, but as a blister agent as well. Skin contact with the agent can produce irritation leading to blisters within 4 to 12 hours. Blister formation may be prevented although, due to its irritating nature upon skin contact, hence alerting the victim to its presence. Eye contact of the vapor can lead to severe irritation, with temporary eye illness. Inhalation of the agent can be fatal in high concentrations, and chronic exposure to low concentrations may lead to systematic poisoning resulting in permanent illness. Vinylarsine has demonstrated potential military use, and its greatest aspect is that it's a liquid. Unlike most blood agents, which are gases, vinylarsine can be used in field operations to contaminate environments. It is volatile under normal conditions, but its volatility is far less than that of the other blood agents. Vinylarsine can persist in the environment for up to 7 days under affluent conditions; cool and dry. Warm and moist environments are less suitable for vinylarsine

## Chapter 6: The Preparation of blood agents

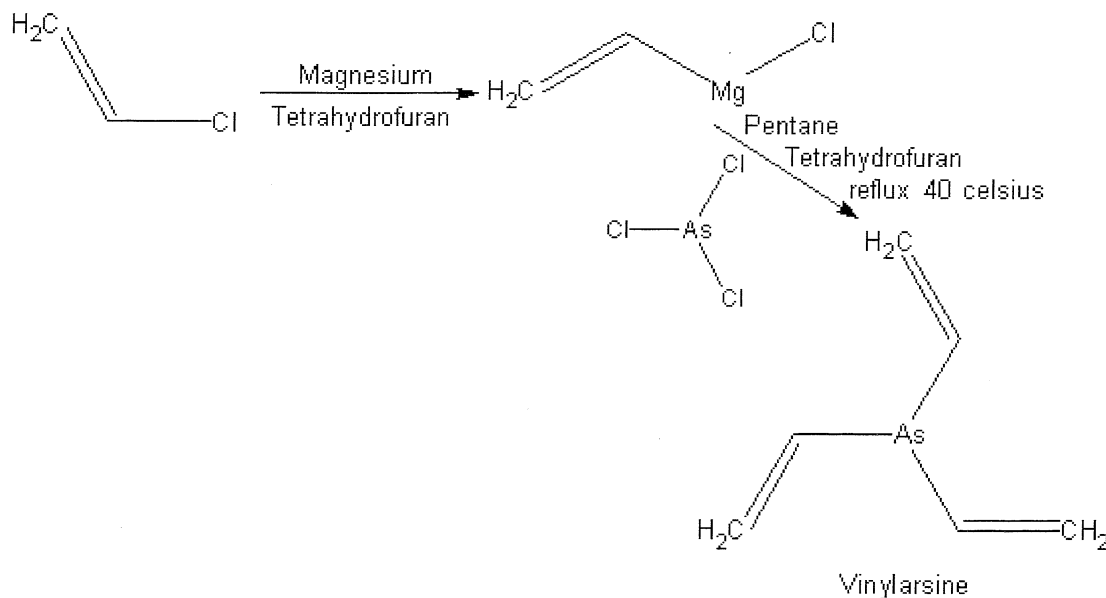
due to volatility and decomposition. Within enclosed areas such as bunkers, tunnels, and rooms, vinylarsine can demonstrate excellent persistence; being able to last for up to 2 weeks or longer. Vinylarsine is best disseminated from aerosols, but it can be effectively disseminated using explosives munitions, atomizers or humidifiers, or foggers. Vinylarsine can penetrate through certain rubbers. Some military gas masks may be susceptible to absorption by vinylarsine, rendering them ineffective at removing said agent.

**Vinylarsine is a moderate fast acting blood agent capable of causing casualties with minutes of dissemination. Vinylarsine can also be used as blister agent; causing blisters within 32 hours of exposure to liquid or vapor. Inhalation of vinylarsine can produce immediate irritation and pain, but in some cases these effects can be delayed by up to 8 hours. Skin contact to as little as 15 milligrams may produce significant irritation. The lethal dose through inhalation in the average man ranges from 250 milligrams to 1500 milligrams. Inhalation of as little as 1500 to 2500 parts per million over period of 15 to 30 minutes can lead to death some cases. As little as 15 to 20 milligrams of the vapor or liquid on the skin can result in blisters up to 32 hours of exposure if not immediately treated.**

OVERALL RATING (scale from 1 to 10)	
<i>Effectiveness (as blood agent): 7</i>	<i>Field Stability: 8</i>
<i>Persistence (open area): 7</i>	<i>Storage stability: 9</i>
<i>Persistence (enclosed area): 9</i>	<i>Toxicity (as blood agent): 6</i>
<b>TOTAL EFFECTIVENESS (as blood agent): 7.6</b>	
<b>OVERALL TOXICITY (as warfare agent): 6</b>	

### Procedure 2-006A: Preparation of Vinylarsine

**Summary:** Vinylarsine is prepared in a two-step process starting with the formation of vinylmagnesium chloride. This vinyl magnesium chloride intermediate is prepared using the Grignard reaction where by vinyl chloride dissolved in tetrahydrofuran is reacted with magnesium turnings. The resulting vinylmagnesium chloride is then treated with arsenic trichloride in pentane, refluxed, and then stood overnight to form the desired vinylarsine. The vinylarsine is then recovered by first, adding water, removing the pentane layer containing the dissolved product, and then distilling this layer at ordinary pressure to obtain the purified vinylarsine. Note: The preparation of vinylarsine discussed in this procedure is similar or related to the process discussed in serial number 671,372, July 12<sup>th</sup>, 1957, by Hugh E. Ramsden, of Scotch Plains, NJ; assigned to Metal & Thermit Corporation. This process may be protected by industrial/commercial process applications. Consult said application number before using the mentioned process for commercial or industrial purposes.



#### Reaction Equation (by products omitted)

<b>Materials:</b>	1. 31 vinyl chloride gas (lecture bottle)	4. 500 milliliters of tetrahydrofuran
	2. 12 grams magnesium turnings	5. 500 milliliters of pentane
	3. 30 grams of arsenic trichloride	6. 5 grams of anhydrous sodium sulfate

#### Hazards:

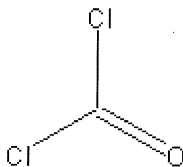


Do not attempt in anyway to prepare vinylarsine using the following procedure unless proper safety precautions are taken. 1) Perform all operations in a clean box, in which is completely sealed from the air. Note: A clean box in this case is not needed. Vinylarsine can be safely prepared as long as the maker wears proper gas mask, and nitrile gloves. 2) After each procedure, all glassware and non-electric equipment should be soaked in bleach before removing from the clean box, and/or before rinsing and storing. Any electrical equipment that may be contaminated (even if suspected), such as hot plates and stirring equipment should be carefully wiped down with a rag soaked in bleach, followed by wiping down with hot water. 3) The desired vinylarsine product should be stored in amber bottles, preferably non-breakable containers, and stored in a refrigerator away from sunlight. The bottles should also be placed inside an airtight sealed plastic bag, such as a 'ziplock' bag. 4) Storage of this blood agent should be in airtight refrigerators, and said storage spaces should be equipped with chemical agent detection monitors to alert of any potential leakage.

Use great care when handling arsenic trichloride, which is very poisonous and can be absorbed through the skin leading to systematic poisoning. Use caution when handling tetrahydrofuran, which is highly flammable and explosive. Perform the peroxide test before using tetrahydrofuran, which has been stored for some time. Use care when handling vinyl chloride, which is a suspected carcinogen, and an irritant.

**Procedure:** Into a suitable flask, place 500 milliliters of tetrahydrofuran, and then bubble into the tetrahydrofuran, 31 grams of vinyl chloride. Once all the vinyl chloride gas been added, place the mixture into an ice bath, and chill to 0 Celsius. When the temperature of the mixture reaches 0 Celsius, carefully add, in small portions, 12 grams of magnesium turnings. During the addition of the magnesium, vigorously stir the tetrahydrofuran mixture, and maintain its temperature below 50 Celsius. After the addition of the magnesium, continue to stir the reaction mixture below 50 Celsius for about 1 hour. After 1 hour, place 250 milliliters of pentane into a clean flask, and then add and dissolve 30 grams of arsenic trichloride into the pentane. Then gently heat this arsenic trichloride/pentane mixture to reflux at about 40 Celsius. Then slowly add, over a period of about 2 hours, the tetrahydrofuran/vinyl chloride/magnesium mixture drop wise, while vigorously stirring the arsenic trichloride/pentane mixture and refluxing it at a temperature of around 40 Celsius. After the addition, continue to stir the reaction mixture for about 1 hour, and then remove the heat source, and allow the reaction mixture to cool to room temperature. After the reaction mixture has cooled to room temperature, allow it to stand overnight for 12 hours at room temperature. Then add in 500 milliliters of cold water, and then stir the whole reaction mixture for 30 minutes. Note: A two-layer mixture will result. Thereafter, remove the upper organic layer using a separatory funnel, and then extract the lower water layer with 250 milliliters of pentane, and then remove the upper pentane layer using a separatory funnel. Note: In some cases the pentane layer might be the bottom layer. Then combine both pentane layers, and then add 5 grams of anhydrous sodium sulfate (to absorb water), and stir the mixture for several minutes. Then filter-off the sodium sulfate, and then place the filtered pentane mixture into a distillation apparatus, and distill at 124 Celsius at atmospheric pressure to obtain a purified vinylarsine product. Redistillation of the vinylarsine is not needed for use in military operations.

## 02-007. Phosgene. Carbonyl chloride. *Carbonic dichloride; chloroformyl chloride*



Phosgene

Phosgene forms a colorless gas, which condenses to a colorless to slightly yellow liquid. It has melting point of -118 Celsius, and a boiling point of 8 Celsius. It is readily condensed into a colorless fuming liquid at 0 Celsius. Phosgene is only slightly soluble in water, but it is soluble in benzene, toluene, glacial acetic acid, and most hydrocarbon solvents. Phosgene has a suffocating odor, which smells of moldy hay when in dilute concentrations. The gas can be detected by its odor, as well as suffocating nature when in high concentrations, but it can go unnoticed, even in high concentrations. Phosgene is a highly poisonous gas, and it is regarded as a very

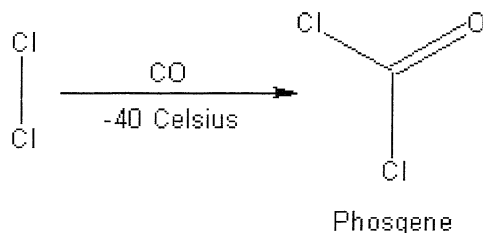
## Chapter 6: The Preparation of blood agents

insidious poison, meaning it tends to linger. Phosgene is not immediately irritating upon skin, and eye contact, and inhalation of the gas is not immediately irritating either, even when in high concentrations. It is a powerful choking agent, as well as blood agent, and it is capable of producing a symptom, which is called "dry land drowning". This symptom refers to the physiological and agonizing effects an exposed person suffers after inhalation of high concentrations of phosgene. In essence, the gas causes severe fluid buildup in the lungs, resulting in a sense of "drowning". Even inhalation of low concentrations of the gas can lead to severe fluid buildup in the lungs. Inhalation of lethal concentrations of the gas may lead to death within minutes. Chronic exposure to non-lethal concentrations of the gas can lead to pulmonary edema, pneumonia, choking, coughing, and painful breathing. The persistence of phosgene is relatively low in the environment due to its volatility, but when used within enclosed areas, it can be highly persistent; lasting for days to weeks under normal conditions. Even though its persistence in the environment is rather poor, its use in field operations is still regarded as "effective" due to its choking nature. Personnel exposed to high, moderate, and even low concentrations of the gas will experience excessive fluid build up in the lungs, resulting in respiratory difficulties. Personnel who inhale the gas, and then mask themselves (as trained to do when under chemical attack), may feel a strong urge to de-mask due to respiratory distress effects including coughing, vomiting, severe runny nose, and congestion. When the agent is disseminated within enclosed areas, exposed personnel will most likely die from inhalation. Phosgene is highly effective when disseminated along with the nerve agents; the phosgene causes severe coughing, runny nose, and respiratory illness, which makes it highly difficult for personnel to keep their gas masks on. Phosgene is best disseminated from aerosols. Inhalation of phosgene produces incapacitation to any exposed personnel due to excessive fluid buildup in the lungs, and severe runny nose and congestion. These effects make it extremely hard for personnel to carryout their normal duties. Phosgene is easily decontaminated with bleach, or strong alkali. **Phosgene is fast acting blood and choking agent capable of producing casualties within minutes of dissemination. Eye and skin contact to the gas or liquid is relatively non-irritating, and irritation usually only develops after 1 to 4 hours. Inhalation of the gas is non-irritating as well, but irritation usually follows within 1 hour of exposure. The direct lethal dose through inhalation is as high as 3200 milligrams per person, but may be as low as 1200 milligrams. Inhalation of as little as 1500 to 3500 parts per million over prolonged periods of time ranging from 30 to 60 minutes can lead to death. Phosgene through skin and eye absorption is relatively non toxic, but eye and skin absorption of as little as 150 milligrams can lead to systematic toxic effects in some people.**

OVERALL RATING (scale from 1 to 10)	
<i>Effectiveness (as blood agent): 10</i>	<i>Field Stability: 5</i>
<i>Persistence (open area): 6</i>	<i>Storage stability: 8</i>
<i>Persistence (enclosed area): 9</i>	<i>Toxicity (as blood agent): 6</i>
<b>TOTAL EFFECTIVENESS (as blood agent): 7.3</b>	
<b>OVERALL TOXICITY (as warfare agent): 5½</b>	

### Procedure 2-007A: Preparation of Phosgene (liquid chlorine process)

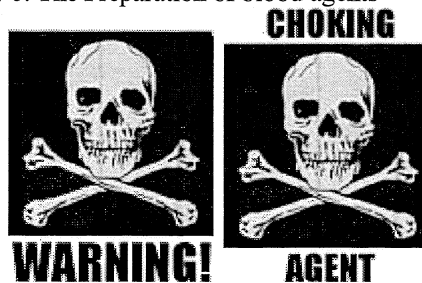
**Summary:** Phosgene is prepared by reacting carbon monoxide with excess chlorine. The excess chlorine acts as a solvent. There are numerous modifications to the process, but the general process includes absorbing carbon monoxide into liquid chlorine, and then allowing the reaction mixture to self distill. This self-distilling process is carried out by placing the reaction mixture into an ice bath, and then allowing the unreacted liquid chlorine to first evaporate, followed by the phosgene. Note: The carbon monoxide used in the reaction can be obtained from a commercial source, such as a gas cylinder, or it can be obtained by heating a mixture of finely divided calcium carbonate with zinc dust at 100 celsius, followed by cooling the carbon monoxide gas with a cold water condenser before its addition to the liquid chlorine.



*Reaction Equation (by products omitted)*

<b>Materials:</b> 1. 90 grams of dry chlorine gas	2. 28 grams of dry carbon monoxide
---	------------------------------------

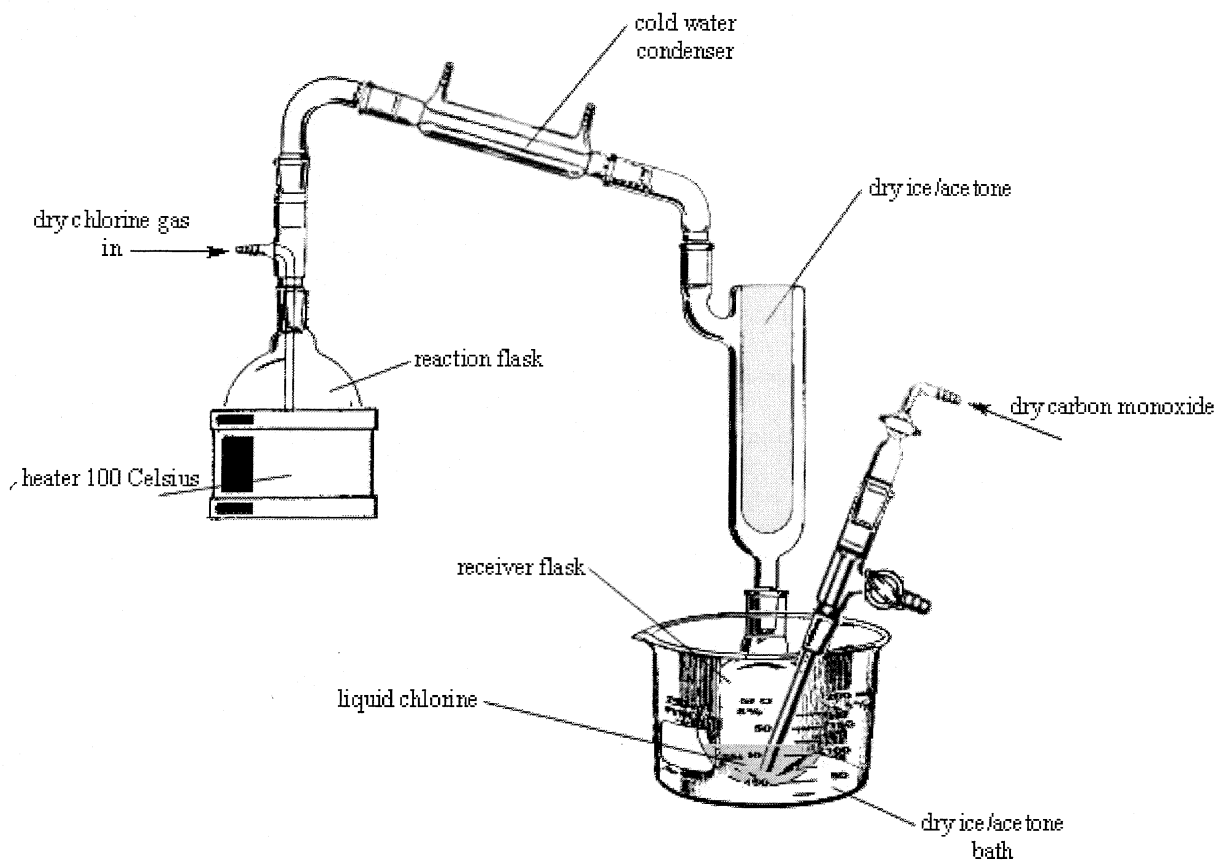
**Hazards:**



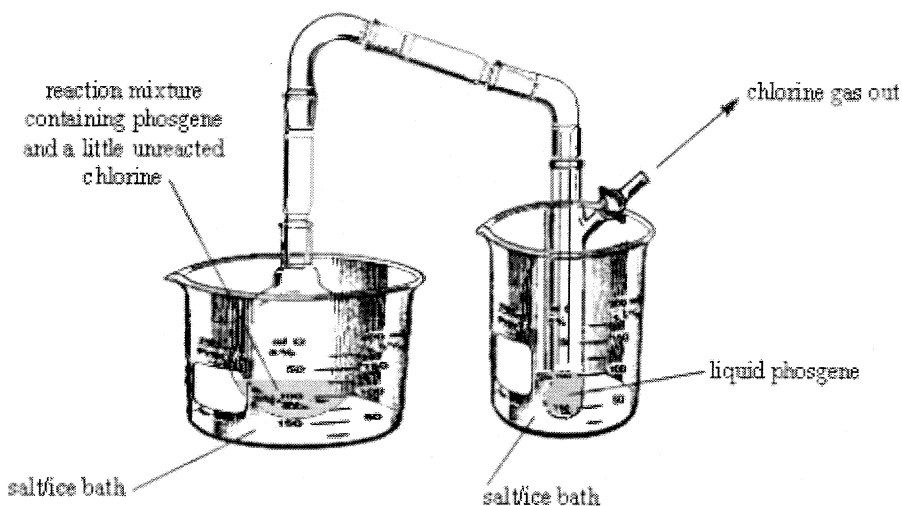
Do not attempt in anyway to prepare phosgene using the following procedure unless proper safety precautions are taken. 1) Perform all operations in a clean box, in which is completely sealed from the air. Note: A clean box in this case is not needed. Phosgene can be safely prepared as long as the maker wears proper gas mask, and nitrile gloves. 2) After each procedure, all glassware and non-electric equipment should be soaked in bleach, or strong alkali solution before removing from the clean box, and/or before rinsing and storing. Any electrical equipment that may be contaminated (even if suspected), such as hot plates and stirring equipment should be carefully wiped down with a rag soaked in bleach, or strong alkali solution followed by wiping down with hot water. 3) The desired phosgene product should be immediately packaged into lecture bottles or pressure containers, or stored in amber glass bottles in a cold freezer until use. 4) Storage of this agent should be with lecture bottles or pressure containers, and said containers should be stored in cabinets equipped with chemical agent detection monitors to alert of any potential leakage. Freezers for the storage of phosgene in amber glass bottles should also be equipped with chemical agent detector monitors.

Use caution when handling chlorine gas, which is toxic and very irritating. Use care when handling carbon monoxide, which a deadly blood agent.

**Procedure:** Assemble the apparatus in illustration 035, followed by the apparatus in figure 036. In apparatus 035, pass 90 grams of dry chlorine gas into the reaction flask, which is heated to 100 Celsius. The heated chlorine gas then passes over to the cold-water condenser, where it is cooled, and the chlorine gas then proceeds into the dry ice/acetone trap. The dry ice/acetone trap condenses the chlorine into a liquid, which then drips into the receiver flask. Note: The dry ice/acetone trap, and condenser should be at  $-50$  to  $-40$  Celsius at all times. Once all the chlorine gas has been passed through the reaction flask, and exists as a liquid in the receiver flask, bubble 28 grams of dry carbon monoxide into the receiver flask. The receiver flask is kept in a dry ice/acetone bath to keep the chlorine liquid during the addition of the carbon monoxide. After all the carbon monoxide has been added, assemble the apparatus illustrated in figure 036; simply remove the necessary glass components, and replace them with the appropriate ones. Thereafter, place the flask containing the reaction mixture into an ice bath, and slowly allow the ice bath to melt, and warm to a temperature of room temperature. During the warming process, the excess liquid chlorine will first volatilize, forming gaseous chlorine, which will be vented off, and the phosgene gas will volatilize into a gas, and will be carried over to the salt/ice bath, where it will condense into a liquid. Note: The salt/ice bath should be at  $-10$  Celsius at all times. The collected liquid phosgene should be immediately stored into lecture bottles, pressure containers, or stored in amber glass bottles in a freezer. Note: Freezers are not recommend because power failures can result in warming that would cause the agent to volatilize.



**Figure 035.** Apparatus used for the reaction of carbon monoxide with liquid chlorine. After the addition of the carbon monoxide, the phosgene product will be in the receiver flask. Note: The reaction flask only contains chlorine gas, and the heat applied to the reaction flask promotes condensation of the chlorine. When chlorine gas is heated, and subjected to a very cold surface, it condenses into a liquid simultaneously.



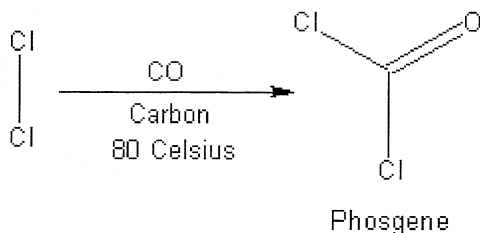
**Figure 036.** Apparatus for the self-distillation of phosgene. A mild vacuum can be applied to help speed up the process.

**Procedure 2-007B: Preparation of Phosgene (carbon process)**

**Summary:** Phosgene can be prepared in a modified manner by mixing chlorine and carbon monoxide in the presence of activated charcoal. The chlorine and carbon monoxide gases are passed through two connecting tubes, both of which contain a fine bed of

## Chapter 6: The Preparation of blood agents

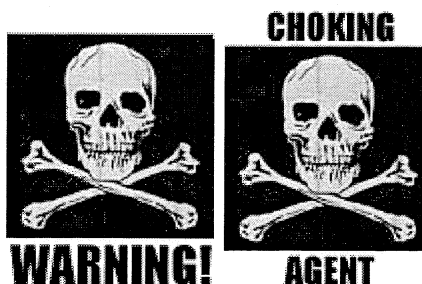
activated charcoal (about 25 grams each tube). The resulting gas stream exiting the apparatus is cooled, and the desired phosgene product collected by condensation. Note: The preparation of phosgene discussed in this procedure is similar or related to the process discussed in application number 645,938, December 31<sup>st</sup>, 1975, by Serge Doubovetzky, and Peter Forschner, both of Toulouse France; assigned to Societe Toulousaine de Produits Chimiques. This process may be protected by industrial/commercial process applications. Consult said application number before using the mentioned process for commercial or industrial purposes.



*Reaction Equation (by products omitted)*

<b>Materials:</b>	1. 90 grams of dry chlorine gas	2. 40 grams of dry carbon monoxide
	2. 50 grams of activated charcoal	

### Hazards:



Do not attempt in anyway to prepare phosgene using the following procedure unless proper safety precautions are taken. 1) Perform all operations in a clean box, in which is completely sealed from the air. Note: A clean box in this case is not needed. Phosgene can be safely prepared as long as the maker wears proper gas mask, and nitrile gloves. 2) After each procedure, all glassware and non-electric equipment should be soaked in bleach, or strong alkali solution before removing from the clean box, and/or before rinsing and storing. Any electrical equipment that may be contaminated (even if suspected), such as hot plates and stirring equipment should be carefully wiped down with a rag soaked in bleach, or strong alkali solution followed by wiping down with hot water. 3) The desired phosgene product should be immediately packaged into lecture bottles or pressure containers, or stored in amber glass bottles in a cold freezer until use. 4) Storage of this agent should be with lecture bottles or pressure containers, and said containers should be stored in cabinets equipped with chemical agent detection monitors to alert of any potential leakage. Freezers for the storage of phosgene in amber glass bottles should also be equipped with chemical agent detector monitors.

Use caution when handling chlorine gas, which is toxic and very irritating. Use care when handling carbon monoxide, which a deadly blood agent. Activated charcoal is flammable.

**Procedure:** Set-up the apparatus illustrated in figure 037 (make sure to fill each tube with a fine layer of activated charcoal, 25 grams each tube), and then pass 90 grams of dry chlorine gas, and 40 grams of dry carbon monoxide through the apparatus; both gases should be added simultaneously and evenly. The electric heating coils should be at 80 Celsius all throughout the gas flow. Phosgene gas will be steadily evolved, and it will carry over with unreacted chlorine, and carbon monoxide. The phosgene is then condensed into liquid phosgene by means of a salt/ice bath. The salt/ice bath should be at -10 Celsius at all times. If a steady flow of chlorine and carbon monoxide is available, this process can be used to continuously prepare phosgene. The collected liquid phosgene should be immediately stored into lecture bottles, pressure containers, or stored in amber glass bottles in a freezer. Note: Freezers are not recommend because power failures can result in warming that would cause the agent to volatilize.

Chapter 6: The Preparation of blood agents

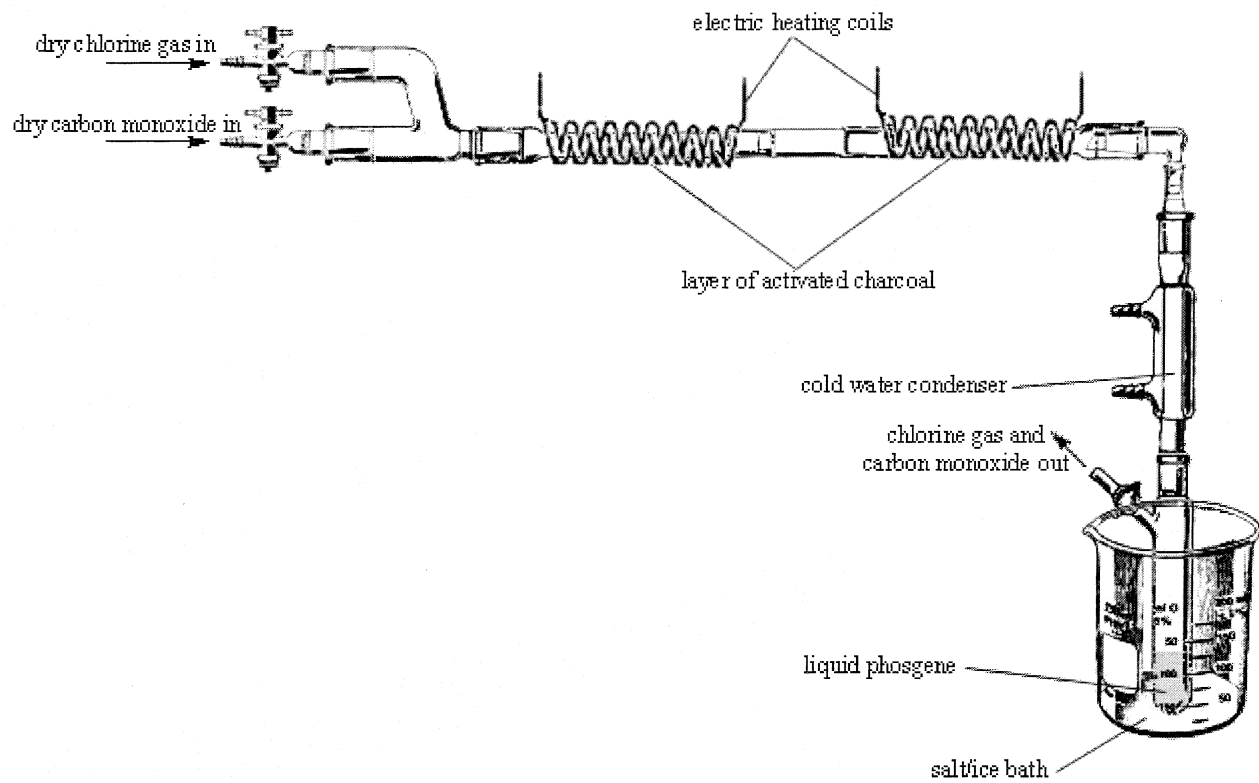


Figure 037. Apparatus for the preparation of phosgene.



# Section IV

## BLISTER AGENTS (POTENT VESICANTS: TISSUE DAMAGING AGENTS)

### Chapter 7: Physical Nature of Blister agents

#### Introduction

The blister agents, or vesicants are a class of chemical compounds that react with tissue producing series damaging effects. Blister agents are capable of producing burn like damage to the skin, eyes, respiratory tract, and gastrointestinal tract. Many of these burns resemble fire burns. Exposure to blister agents leads to horrific blisters, soars, welts, and burns within 24 hours of exposure and these effects can be very painful in nature. The blisters themselves usually contain secondary toxic compounds as the fluid, which can cause the blisters, soars, or burns to spread over wider areas of the body.

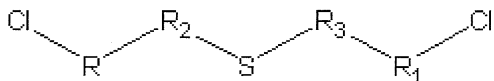
There are four major classes of blister agents: 1) Sulfur mustards, 2) Nitrogen mustards, 3) Arsenicals, and 4) Halogenated oximes. Sulfur mustards are the most well known, and were first prepared in the early 1800's by German and French chemists. Their damaging nature upon the skin was not realized until the late 1800's when they were then mass produced by the Germans for use in warfare; large amounts of mustard gas were used by the Germans during World war I, resulting in the deaths of over 120,000 French, and British troops. Note: American casualties from mustard gas and other chemical attacks by the Germans were virtually non-existent due to the fact the America did not get involved in the war until it was practically over with.

Mustard gas was the first chemical warfare agent used on a massive scale in war, and it paved the way for the future of chemical warfare. Nitrogen mustards were developed some decades later, and are more potent then the sulfur mustards. Arsenicals were adopted around the time period, and they have similar effects. Arsenicals can double not only as blister agents, but blood agents as well.

Blister agents are designed to contaminate areas to halt enemy troop movements, divert movements, force enemy troops to remain in full protective gear for long periods of time thereby degrading motivation and moral, and to harass, and confuse enemy personnel. Blister agents are used to produce injuries rather than to kill, although exposure to them can be fatal under appropriate conditions. Blister agents are very persistent in the environment, especially during dry and cold periods. They are capable of penetrating rubber, wood, clothing, vegetation, and some plastics. Areas contaminated with blister agents can give rise to casualties' weeks after dissemination. Simply sitting down on a patch of grass contaminated can lead to poisoning. Example, during World War I, a British soldier sat down on a patch of grass, which was unknowingly contaminated with mustard gas (in the form of small droplets). Several hours after the exposure, he developed severe blisters and burns on his butt and backside. This contaminated area was thought to have been cleared after its contamination three weeks earlier.

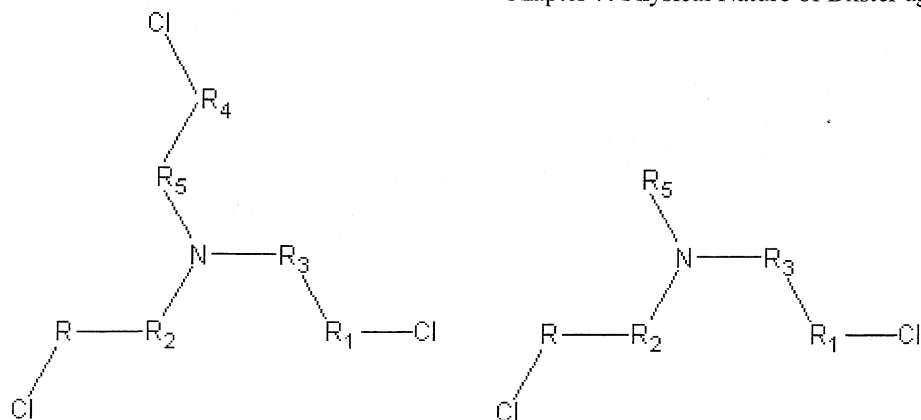
#### I. Mustard agents

Mustard agents are derived into two groups: 1) Sulfur mustards and 2) Nitrogen mustards. The sulfur mustards are classified by the following group.



R, R1, R2, and R3 can be methyl, ethyl, or isopropyl groups, but are usually methyl groups. The chlorines on the R and R1 groups can be replaced by bromine, but this is not usual. The chlorine atoms are usually on the beta position, meaning off the R and R1 groups. If the chlorines were off the R2, or R3 groups, vesicant properties would still exist, but would be less severe. All sulfur mustards are classified by their central sulfur atom, which is clearly visible at this point.

Nitrogen mustards are similar to sulfur mustards, but the central sulfur atom is replaced by nitrogen. The chlorines of nitrogen mustards are in the usual places.



In the above figures, all the R groups can be methyl, ethyl, propyl, isopropyl, or tert-butyl. The chlorines can be replaced with bromine, but this is not usual.

### Physical and Chemical properties

The mustards are all colorless to brownish liquids with characteristic odors. They are very soluble in most common organic solvents, and they are capable of penetrating (though absorption) cell membranes in tissues, as well as a great number of materials including wood, leather, rubber, plants, fibers, and some plastics. The penetrating nature of mustards makes it very difficult to adequately protect personnel, as many types of clothing can be penetrated by the mustards. Mustards are very persistent in the environment especially in cold and temperate climates. The persistence of the mustards can be greatly increased by dissolving them in chlorinated rubber. This action produces what is known as “thickened” mustards. Thickened mustards can persist up to five times longer than ordinary mustards. Thickened mustards can be disseminated and sprayed from hand held systems similar to flame throwers to stick to, and contaminate environments such as caves, bunkers, tunnels, ships, buildings, and more.

In warmer climates the persistence of the mustards is decreased due to hydrolysis, but higher rates of vapor occur in these climates making the mustard agents more hazardous through inhalation.

The persistence of the mustards within water is dependent on several factors. Mustards as drops on the surface of water can persist for several days, or up to a week. Since mustards are insoluble in water, they form a two-phase mixture; the mustards being the bottom layer. Even though the mustards are denser than water, droplets tend to linger on the surface of water. Persistence of mustards with running or mobile water is much lower due to higher surface areas. In some cases, droplets of mustards on the surface of water can last up to 3 months. As expected, alkaline solutions greatly increase the rate of hydrolysis.

Sulfur mustards are easily destroyed with strong oxidizing agents, such as bleach, bleaching powder, potassium permanganate, nitric acid, and potassium dichromate. Nitrogen mustards however, are much less reactive than the sulfur mustards, and destruction via oxidation is very difficult. In most cases, nitrogen mustards must be neutralized with chemicals such as sodium hydroxide, metallic sodium, and chlorinated phenols. In most of these cases, decontamination of nitrogen mustards is very difficult, especially under field conditions where they can linger in many locations.

### Detection

The mustards can be detected using indicator paper composed of para-nitrobenzpyridine. This indicator paper can detect traces of mustard in the air. Upon exposure to trace amounts of mustards, the indicator paper changes from colorless to deep blue or red; although, the color may vary from pink to yellow to green depending on the traces of mustard agent present, and the exact mustard agent present. These indicator papers are widely available, and are issued to military personnel. The indicator paper can be used by simply attaching a strip onto the soldiers' helmet, LBE, or rucksack. Most militaries have electronic monitors that can detect mustards over a wide range of concentrations.

### Protection

Ordinary clothing gives little protection to the mustards. Most clothing can be penetrated by mustards, and only specialty clothing such as NBC suits, and appropriate chemical suits provide any protection. Even the US militaries NBC clothing can absorb appreciable amounts of the mustard agents giving rise to blisters and/or systematic poisoning. Most so-called military protective clothing must be changed regularly regardless of effectiveness because mustard agents slowly absorb through most known clothing. Some full body suits made of special polymers can provide full protection, but would lead to body suffocation resulting in dizziness, and collapse due to poor ventilation; think of wearing a full body wet suit for prolonged periods of time without going into the water. In this case, these types of suits would be impractical for soldiers working and living under field conditions.

Currently, there are no antidotes or cures against blister agent exposure or contamination. It is possible to protect the skin from low vapor and droplet concentrations by applying to the skin an ointment made of choroamine (or a chlorinated phenol) and petroleum jelly, but this treatment appears to be far to impractical for massive field operations. The only practical method of skin protection is the use of standard military protective clothing, which must be changed periodically.

### Decontamination

The problems with decontamination is the fact that exposure to mustard agents is delayed. Skin and eye contact can be delayed for up to 12 hours. Exposure of mustard agents through inhalation can be delayed up to 8 hours. In many cases, immediate exposure through inhalation produces no irritation or pain. In some cases, skin exposure can lead to mild irritation due to partial hydrolysis of the mustard agent producing hydrochloric acid. In this case, the skin must be moist in order for the slight irritation to occur.

Decontamination of the eyes and nose is difficult, and almost impossible. The only relevant thing to do is flush the eyes with excessive amounts of warm soapy water, followed by a dilute solution of sodium bicarbonate. The eyes should then be flushed with large amounts of warm water. A dilute paste of phenol can be applied to the eyelids and the skin around the eyes, to provide relief and some healing effects. This phenol paste can be replaced by common Chap Stick containing phenol.

Decontamination of the skin is relatively easy, but as previously mentioned, symptoms are delayed. Avoiding burns and blisters can be tricky, but as soon as symptoms appear, the skin should be immediately scrubbed with a sponge or brillo pad along with hot soapy water. Thereafter, the effected areas should be washed with gasoline or other hydrocarbon solvents. A dilute phenol mixture made of wax or jelly can be applied to the skin to relieve pain and help healing. Do not flush the wounds directly with water, unless over a sink. Scrubbing the wounds with excessive amounts of water can actually spread the agent over more skin areas, especially if splashing occurs.

Overall, decontamination of mustard agents is difficult primarily due to their delayed action. A simple drop of HN3 on the skin for example, produces no immediate irritation, and the agent is absorbed within minutes. Within 12 hours, wounds will begin appearing. As soon as wounds begin forming, decontamination should begin immediately. If untreated, within 24 hours the blisters will begin to spread, contaminating more areas of flesh. In essence, exposure to mustard agents is like the flesh-eating virus; it destroys tissue producing ugly and grotesque injuries. The degree to which the agent spreads is predominantly based on the amount of mustard agent absorbed. Usually, small drops or vapor will only contaminates small areas of the skin, but in some cases, larger areas can be effective. If there is any doubt to whether you might be exposed to mustard agents, you should always immediately decontaminate yourself using standard issue kits.

Decontamination of the penis, vagina, or the rectum should be carefully carried out by medical staff. The effected areas in this case should be treated with a dilute chlorine water solution, followed by irrigation with saline solution. As you might imagine, contamination of the penis, vagina, or rectum area with mustard agents would be a nightmare on its own level. Documented cases of persons exposed in this manner have occurred, but all persons made full recoveries (some after skin graphs, and other surgeries). The rectum can absorb mustard agents three times faster then normal skin. Absorption of mustards agents through the rectum can lead to series injury, but nothing life threatening (all though you might wish it had).

### Mechanism of action

Sulfur and nitrogen mustards are bifunctional alkylating agents capable of reacting with the backbone elements of tissue. They also chemically react with DNA and RNA. The mustards chemically react with cellular components within the skin to produce alkylsulfonium ions (for sulfur mustards), or alkylethylenimonium ions (with nitrogen mustards). Reactions with DNA produce monofunctional adducts forming alkyl hydroxyalkyls, with bifunctional binding leading to formation of cross-links between the mono and bifunctional adducts. Alkylation with RNA, proteins, cellular membrane components, and cross-linked molecules between DNA and proteins is the main result of cellular damage causing blisters. In essence, the mustard agents react with elements within the tissue including DNA, RNA, proteins, and cellular membrane components resulting in extreme tissue damage. Because mustards react with DNA, it's possible that exposed personnel who make full recoveries might actually be able to pass the damaged genes over to their kids resulting in potential birth defects, or mental illness.

For DNA, the relative instability of the reaction products as a result of mustard contamination affects the guanine N7-alkylation, which is released from the DNA segment. Upon DNA replication, the remaining apurinic sites do not provide proper replicates or proper templates of information to the surrounding media; as a result, severe erroneous is incorporated into the nucleotides. This activity leads to mutations and synthesis of non-functional proteins resulting in tissue damage, and systematic poisoning; effects which may be permanent in nature.

In general, the presence of damage to the DNA can include cellular repair mechanisms, which may contain problems including error encoding and replication errors; as a result, these processes may give rise to erroneous DNA replications. In other words, the processes lead to mutations of the gene sequence leading to a variety of illnesses. The cross-links including interstrand cross-links, for example, between two guanines may play a crucial role in the cytotoxicity of the mustards. In essence, they inhibit the DNA replication process when they are not properly repaired through normal sequence processes.

### Toxicity of the mustards

The mustards are highly feared chemical warfare agents because of their chemical stability and persistence, their insidious nature for attacking the skin, eyes, and respiratory tract, and because there is no effective treatment for countering their effects. The mustards continue to worry military personnel due to the many problems they pose in the field of protection, decontamination, and treatment. There are two major biological actions that are produced upon the body after exposure to the mustards: 1) cytostatic, and 2) mutagenic. Secondary biological actions after exposure include an array of symptoms by reactions with cellular membranes or critical enzymes. The actions of the mustards upon the skin resemble ionizing radiation, and in some cases, the mustards are called radiomimetic compounds. The predominate order of toxication includes a) proliferating cells, b) basal epidermal cells, c) haemopoietic system, and d) the mucosal lining of the intestine.

The eyes are very sensitive to the mustards, and are more susceptible to contamination than either the respiratory tract or the skin. Levels of mustard agent low to seriously affect the respiratory tract can lead to conjunctivitis after exposure to the eyes within 1 hour. General exposure of the vapor to the eyes produces lachrymation and a sensation of grit in the eyes within 4 to 12 hours. Within 4 to 12 hours as well, the eyelids become red and oedematous. Heavy exposure of the vapor irritates the eyes within 1 to 3 hours and produces severe lesions. Mustard burns of the eyes can be divided into several levels: 1) Mild conjunctivitis (75% of most exposure cases); recovery takes 1 to 2 weeks. 2) Severe conjunctivitis with minimal corneal involvement (15% of most exposure cases); blepharospasm, oedema of the lids and conjunctival occurs within 4 hours, as may an orange-peel like roughness may form on the cornea. Recovery in this case usually takes 2 to 5 weeks. 3) Mild corneal intrusion (9% of exposure cases). Includes areas of the cornea undergoing different degrees of scarring and vascularisation along with iritis. During short periods of time, temporary relapses occur and convalescence may take 2 to 3 weeks under normal conditions. This level of exposure should seek hospitalization immediately. 4) Severe corneal involvement (only about 1% of all eye exposure cases); this level includes ischaemic necrosis of the conjunctival, with dense corneal opacification with deep ulceration and vascularisation. Healing is generally slow, and convalescence may take several months. Patients may suffer from predisposed relapses, although, temporary blindness may occur. Permanent blindness is rare, but possible.

Skin exposure to the mustards is the focal point of mustard agents. In 90% of all casualties as a result of exposure to mustards, skin intoxication is the predominate means for poisoning. Skin exposure to mustard agent is delayed by 4 to 8 hours, 99% of the time. In 1% of cases, skin exposure may develop irritation within 1 hour due to partial hydrolysis forming corrosive hydrochloric acid. The exact severity of skin damage as a result of skin contact depends on concentration, environmental conditions, and time of exposure. In cold climates, skin exposure to blister agents produces less severe effects after 4 to 8 hours due to cold temperatures resulting in low volatility and absorption rates. Warm climates and moist skin are associated with more severe cases of skin toxicity as a result of higher degrees of volatilization. Some people are more sensitive to mustard agents either by vapor or liquid contact. For example, blacks, and tan skinned people are more sensitive to mustard agents.

The sequence of skin damage takes on the following stages: 1) Erythema (develops 2 to 48 hours after exposure). These symptoms of skin exposure resemble that of scarlet fever. There is slight oedema of the skin, itching is very common and may become intense, and erythema fades areas of skin pigment. Other symptoms of this level resemble that of skin burns. 2) Blistering: blister formation is the forefront of mustard agent exposure. They develop within 4 to 8 hours of exposure, and can be massive in size. On average, blisters can be anywhere from 1 to 3 inches in diameter, but larger blisters can form more common than one might suspect. In some cases, blisters will range from 5 to 20 millimeters in diameter. The blisters themselves often contain poisonous fluids, which can lead to additional poisoning; although, with the sulfur mustards, the fluid is usually not poisonous. In essence, most blisters are relatively painless, but they are capable of being very painful and irritating. Most blisters are physiologically painful, and produce emotional distress and discomfort. Blisters located near joints or flexible regions of the body can seriously impede movements resulting in a sense of physical incapacitation. A second crop of blisters may form within 1 week of the original mustard exposure. Casualties should have their blisters and effected areas tightly wrapped in medical bandages to protect further contamination of fresh skin. 3) Severe blisters: Severe blisters are very common in mustard agent exposures, and can lead to painful wounds resembling fire burns with complete loss of skin and tissue in the effected area. Areas contaminated become markedly erythematous, which darkens and may become very hyperpigmented. Brownish to purple to black discoloration of some effected areas may result. These discolorations tend to disappear over a period of several weeks.

Different areas of the skin can give different results. The areas of the face and the mucous membranes are the most sensitive areas, and very little mustard agent is required to produce symptoms. The palms, the soles of the feet, and the skin of the scalp are very resistant to mustards, and only varying concentrations of vapor or liquid will produce discoloration and erythema. Blister formation results with higher concentrations in about 4 to 12 hours.

Most blisters are 1 to 2 centimeters in diameter, but can be much larger. They tend to form domes, which are thin and yellowish, and contain a clear to yellowish liquid. The blisters are very fragile, and usually rupture with ease giving way to suppurating and necrotic wounds. The necrosis of the epidermal cell tends to get extended to the underlying tissues, especially to the dermis. Damaged tissue becomes covered in layers of slough, and become susceptible to infection. The regeneration of this damaged tissue is very slow, and may take between 2 to 3 weeks or even several months to restore the damaged skin areas. In some cases, permanent tissue and skin damage results.

The respiratory tract is very susceptible to attack by mustard agents, as well as all mucous membranes of the respiratory tract. After 4 to 6 hours of exposure, mustards begin to irritate and congest the mucous membranes of the nasal cavity and the throat, as well as the epitheliums of the trachea and large bronchi. Symptoms start with rhinorrhoea, followed by burning pain in the throat and hoarseness of the voice. Dry coughs tend to give way to copious expectoration, and the vocal cords often become damaged resulting in aphonia.

## Chapter 7: Physical Nature of Blister agents

Exposure to the lungs leads to airway secretions and fragments resulting in necrotic epitheliums, which may restrict the lungs. Damaged lower airways become infected easily, with the formation of bronchopneumonia resulting after 48 hours. Inhalation of high concentrations can be fatal within a few days—the cause of death is either from pulmonary oedema or mechanical asphyxia due to fragments of necrotic tissue obstructing the trachea or bronchi, or from superimposed bacterial infection, which results from impaired immune responses.

A less recognized area of the body damaged by mustard agents includes the bone marrow. Mustards can cause general depletion of all elements of the bone marrow. The cells of the granulocyte and megacaryocytes are more susceptible to damage than those of the erythropoietic system. A common mode of damage results by a reactive leukocytosis, which occurs during the first 3 days of mustard agent exposure, followed by a decrease in the peripheral white cell count. Development of severe leucopenia or aplastic anaemia may result.

The gastrointestinal tract is much less common to exposure to the mustards, but it is susceptible to intoxication. Contamination in this regard occurs from ingestion of contaminated food or water. Symptoms include nausea, vomiting, pain, diarrhea, and prostration. Systematic absorption of any mustard under any condition can lead to general systematic poisoning. Effects include headache, nausea, vomiting, skin burns, blisters, respiratory distress, severe tissue damage, gastrointestinal illnesses, CNS depression, cardiac irregularities, radiation like tissue damage, and cardiac arrest.

### **Treatment of mustard lesions**

There is no drug or medical treatment to cure the effects of mustard agents, and there is no specific treatment available for mustard lesions. The direct aim of treatment is to a) relieve pain of symptoms, b) prevent bacterial infections, and c) promote healing of effected areas.

Eye lesions can be very painful, so direct treatment is to relieve the pain and decrease potential for infection. Use of local analgesics (pain killers) may increase corneal damage, and their use to relieve pain is not recommended. Injectable analgesics (narcotics) such as morphine can be administered to relieve general pain, but should not be administered for long periods of time. To prevent bacterial infections, the patients should be given oral doses of antibacterials. The eyes can be flushed with a dilute saline solution, and a dilute phenol gel can be applied to the eyelids, and the surrounding skin.

Skin lesions should be washed with hot soapy water, followed by a dilute chlorine water solution. Care should be taken not to contaminate any other skin during the washing process. For mild skin exposures including general redness and itching, calamine lotion, dilute phenol jelly, water solutions of corticosteroids, or aloe Vera gels can be used to relieve pain after decontamination. Antibacterial ointments and creams should then be applied to decrease chances of infection rather than oral antibacterial doses. Severe skin burns, blisters, wounds, and the like should be decontaminated by scrubbing the wounds, followed by washing with saline and chlorine solutions. Morphine or codeine can be administered through injection prior to the sometimes painful process of scrubbing. Antibacterials should be administered orally to decrease chances of infections. Decontaminated areas can be coated with ointments or creams of aloe Vera gel, or other similar lotions. Treated areas of the skin should be monitored from time to time to check for signs of infection. In essence, the rate and degree at which wounds heal is dependent on the severity of contamination to begin with.

Respiratory tract lesions can be very difficult to treat, and no real medical treatment is available. Mild exposure resulting in cough, soar throat, and hoarseness can be relieved with oral codeine administrations. Severe exposure is easily fatal within days, and the only thing that can be done is to administer antibacterial agents in order to decrease infections; nevertheless, serious injury or death can result from severe lung tissue damage.

Systematic effects, as previously discussed, can be treated using different techniques. The first step is to eliminate the potential for infection. This can be done by administration of antibacterials when it seems fit. One method to decrease systematic effects can be the oral administration of sodium thiosulfate solution, but this must be administered within 20 to 60 minutes of exposure to mustards. Other methods of treatment include administration of morphine, or codeine to relieve pain, and administration of steroids; although, as with other symptoms, there is no real medical treatment, and patients should be monitored around the clock to keep a look at for potential arising symptoms.

### **Secondary infections as a result of mustard agent exposure**

Secondary bacterial infections are a very common complication of mustard burns. Secondary infections may occur several days, to several weeks after exposure. Secondary bacterial infections usually occur with casualties suffering from moderate to severe exposure. Even after decontamination, and superficial treatment of wounds, secondary bacterial infections can occur, but is less of a concern in most patients. Secondary bacterial infections are more common in the respiratory areas, where treatment is best carried out by administration of antibacterial agents. Mild conjunctival burns are associated with pharyngitis, laryngitis, and tracheitis, which tends to increase over several days. Secondary infections usually occur in areas of irritation as a result of the body's attempts to heal the effected areas.

### **Long term effects of mustard exposure**

## Chapter 7: Physical Nature of Blister agents

The long-term effects of exposure to mustard agents are divided into basically three categories: a) Personnel exposed to mustard agents may experience prolonged psychological effects including chronic depression, loss of libido, and anxiety. Many of these effects may be a result of blister agent injuries, which tend to persist for weeks even months resulting in periods of discomfort and irritation. b) Long term physical effects may include visual impairment, scarring of the skin, chronic bronchitis, bronchial stenosis, and increased sensitivity to other wise non-irritating substances. c) Many of the mustards are known carcinogens, and exposure can lead to skin cancer, or other cancers within 5 years of exposure; although, most cases of exposure will not develop cancer. Lung cancer is the greatest cancer risk for exposure to mustard agents, and may affect only 1 to 4% of people exposed to mustard agents through respiratory areas. Exposure of mustard agents to the genital areas may result in genital cancer of various types. In essence, areas of the body more sensitive to mustards are more likely to develop cancer.

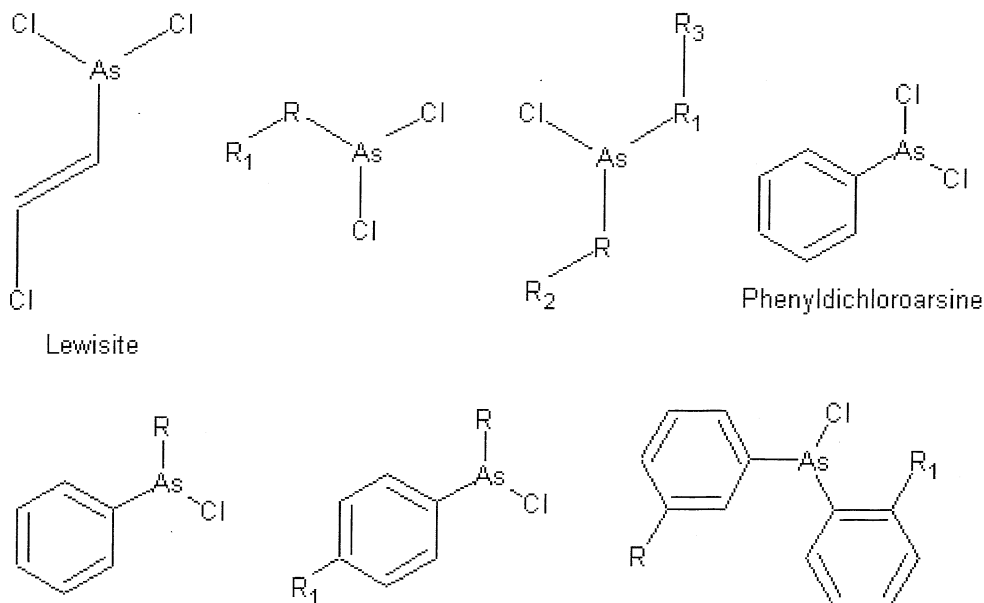
## II. Arsenicals

### Introduction

Arsenicals are another set of vesicants, or skin damaging agents that are capable of producing series burns, welts, blisters, soars, and scarring. The arsenicals contain a central arsenic atom, which is attached either to 1 or 2 chlorine atoms. The bonds between the chlorine and the arsenic are what give the arsenicals their vesicant power. The most common arsenical is lewisite, which was also created and manufactured by the Germans during World War I; although, its use was less than that of the sulfur mustard, mustard gas. The arsenicals are capable of blistering the skin in similar manners as the mustards, and their rates of action can be faster, or slower depending on climates and concentrations—the arsenicals tend to be less stable and persistent then the mustards.

### Physical and chemical characteristics

Most arsenicals are colorless to odorless liquids under purified conditions, but most military grade arsenicals tend to have amber to brownish appearances due to impurities. Many of the arsenicals have germanium like odors also caused by impurities. Pure arsenical compounds are odorless, and give no hint of their presence. Many of the arsenicals are insoluble in water, but readily soluble in most organic solvents. Most arsenicals are hydrolyzed by water at much faster rates then the mustards. The following gives the backbone of the arsenicals:



There are two types of arsenicals: alkyl, and aryl. The alkyl arsenicals include lewisite, methyl dichloroarsine, and diethyl chloroarsine. The R group can be hydrogen, methyl, ethyl, propyl, isopropyl, or tert-butyl. The R1 groups can be methyl, ethyl, propyl, isopropyl, or butyl. The aryl arsenicals include phenyldichloroarsine, and diphenylchloroarsine. For the single aryl arsenicals, the R group can be methyl, ethyl, propyl, isopropyl, or tert-butyl, and the R1 group can be hydrogen, methyl, ethyl, propyl, isopropyl, or tert-butyl. For the diphenylarsenicals, the R and R1 groups can be hydrogen, methyl, ethyl, propyl, isopropyl, or tert-butyl.

### Detection

The detection of arsenicals can be tricky, but a number of detection papers are available. The most common test kit is sold under the name Draeger™, and is composed of tubes containing a reactive substance that changes color when trace amounts of arsenicals are present. No automatic detector systems are available for the detection of arsenicals in the field, and the Draeger tubes must be carried by individual soldiers.

## Protection

As with the mustards, ordinary clothing gives no protection against arsenicals. Arsenicals can penetrate many types of cloth, fibers, rubber, wood, and several plastics; as a result, special chemical suits and protective masks are required for adequate protection.

## Decontamination

Decontamination is the same as for the mustards, see *vide supra*

## Mechanism of action in the body

The vesicant mechanism of action is similar to the mustards. The arsenicals easily penetrate the skin, from which the vesicant symptoms begin. They can spread to certain parts of the body, and they can even spread through out the body acting as a systematic poison. Along with the vesicant properties, arsenicals can act as blood agents by interfering with the hemoglobin group of enzymes. Arsenicals inhibit the pyruvate dehydrogenase within the system, which leads to hemoglobin disorders.

The arsenicals react with lipoic acid, which is an essential part of the pyruvate dehydrogenase system. This action disrupts the pyruvate dehydrogenase action of coenzyme in the formation of acetyl-coenzyme-A from pyruvate. The action of arsenicals upon lipoic acid forms cyclic compounds, which interfere with energy production within the cells.

## Body effects

Contact of liquid or vapor upon the eyes can produce series damage. On contact, pain and blepharospasm occur almost immediately. Oedema of the conjunctival causes the eyes to swell and close within hours. Inflation of the iris occurs readily and rapidly after contact. Several hours after exposure, oedema of the eyelids begins to subside, but haziness of the cronea develops and iritis increases. Concentrations of arsenical exposure to the eyes dictates severity of injury and long term illness. In some cases the eyes may heal without residual effects, but sometimes pannus formation may result, with progression of massive necrosis developing later. The iritis will subside without series or permanent impairment of vision, if exposure to the arsenicals is mild. Exposure to high concentrations of vapor or liquid may cause severe hypopyon, terminating in necrosis, and resulting in permanent impairment of vision. Eye exposure to droplets of arsenicals produce immediate scarring on the contacted surfaces, producing a gray scarring of the cornea. Exposure of the eyes to arsenicals either mild or heavy can lead to secondary infections. In essence, exposure to arsenicals can lead to permanent blindness under many conditions.

Liquid arsenicals on the skin produce more severe lesions than the mustards; although, mustard vapor is more harmful than arsenical vapor. Contamination of the skin leads to erythema, followed by vestication to the entire area. The blisters formed by arsenical exposure are slightly thicker than those of the mustards, and they consist of almost the complete thickness of the epidermis exposed. Arsenical blisters contain a yellowish fluid, which is considered non-toxic, but it does contain arsenic and may be poisonous under certain conditions. In essence, arsenicals produce deeper injuries to the connective tissue and muscle, and greater damage to the vascular area than with mustards. They also produce significant and more severe inflammatory reactions than the mustards. As with the mustards, infection is also a potential illness as a result of exposure. Arsenicals may also produce severe necrosis of the tissue, resulting in gangrene and slough like symptoms.

Unlike the mustards, skin exposure to arsenicals produces irritation within minutes. Irritation and exposure effects may be delayed. Irritation from exposure may increase in severity with penetration with the formation of deep aching pains. Pain and irritation from exposure to arsenicals can help give rise to its presence, allowing for decontamination to immediately begin. After 5 minutes of exposure to the arsenicals, there appears a gray area of dead epitheliums. The erythema is similar to that caused by mustards, but with more pain. Itching and irritation will persist for about 24 hours or longer, regardless of blister formation. Blisters caused by arsenicals are more painful than those produced by the mustards. Pain usually subsides after 48 to 52 hours.

Arsenical vapor is extremely irritating to the respiratory tract. Personnel will immediately be alerted to the presence of arsenicals, as they severely irritate the nose and throat. As with skin contact, inhalation of the arsenicals may be passive rather than irritating. During field operations, few injuries will result from respiratory exposure due to the alerting nature of the irritant substances. Soldiers will immediately put on masks after dissemination. Wounded soldiers who cannot put on their masks due to fighting injuries may suffer from inhalation exposure. In any light, inhalation of the arsenicals produces severe pulmonary oedema, which may be accompanied by pleural effusion.

Systematic poisoning is the most common form of poisoning as a result of arsenical exposure. Liquid and vapor is easily absorbed into the blood stream causing systematic poisoning. One systematic effect arises from capillary permeability, which allows loss of sufficient fluid from the bloodstream leading to haemoconcentration. Later effects of this symptom lead to shock, and then death.



Excretion of oxidized products into the bile by the liver produces necrosis of the organs, necrosis of the mucosa of the biliary passages with peribiliary hemorrhages and some injury. Systematic poisoning from large skin burns causes pulmonary oedema, diarrhea, restlessness, weakness, lower body temperature, and low blood pressure.

### **General treatment**

Although treatment of arsenicals can be difficult, there is medical treatment in the form of an antidote. The antidote is a compound called dimercaprol (2,3-dimercapto-propanol), and it is a colorless liquid, which is only slightly soluble in water. It is administered in very dilute aqueous solution either intravenously, or orally, and it converts the arsenic into water-soluble complexes. The water-soluble complexes are easily removed from the body through excretion. Dimercaprol also reactivates certain enzymes within the hemoglobin system, thus providing a cure for cases of systematic poisoning. Dimercaprol is toxic, and administration should be carried out by medical personnel only. In general, dimercaprol can be used for general skin poisoning, and systematic poisoning, but it has no effect against already formed blisters and wounds.

The eyes can be treated by a dimercaprol eye ointment, which may diminish the effects of arsenical exposure if applied within 5 minutes of exposure. Delayed application will decrease effectiveness in treatment. In severe cases, morphine is administered to relieve pain. Atropine sulfate ointments can be applied to severe eye injuries with some rates of recovery. Along with the ointments, antibacterial agents should be administered to decrease potential of infections. For general treatment, medical grade saline solutions can be used to flush the eyes.

Dimercaprol can be applied to the skin to treat exposure, but the dimercaprol must be applied within 15 minutes of skin exposure to arsenicals. The dimercaprol can be used to treat skin wounds, but only before blister formation. Other wise treatment of blisters caused by exposure to arsenicals is similar to that of the mustards. Severe burns caused by arsenicals resemble those of fire burns, and should be medically treated in the same manner as actual thermal burns. Morphine is usually administered to relieve pain, and antibiotics are administered to suppress infections.

## **III. Phosgene oxime**

### **Introduction**

Phosgene oxime is the most common oxime from a small group of compounds called halogenated oximes. The halogenated oximes were discovered in the late 1800's, and their use in warfare was considered almost immediately. The chlorinated oximes, are notoriously known as some of the most irritating substances known to man. Phosgene oxime was nicknamed nettle gas, or hornet gas because of its stinging sensation upon skin contact. Phosgene oxime is a powerful irritant, and its use in warfare is most practical.

### **Physical properties of phosgene oxime**

Phosgene oxime is a white crystalline compound, but it may be colored in variation due to impurities. It has a melting point of 40 Celsius, and a boiling point of 129 Celsius. The compound is fairly soluble in water, and most common organic solvents. Water solutions decompose phosgene oxime at an appreciable rate, and it should be stored dissolved in inert solvents in a refrigerator. Alkaline solutions increase the rates of decomposition. Phosgene oxime may begin to decompose at room temperature.

### **Detection**

Phosgene oxime is so irritating its presence is clearly evident. Other than general contact with the agent, there is no direct methods of detection.

### **Protection and decontamination**

Like most vesicants, ordinary protective clothing gives no protection to phosgene oxime. Phosgene oxime can be absorbed through most clothing where it then can act upon the skin. It is capable of penetrating some polymers, and rubbers, as well as wood. Special protective suits, as well as special gas masks are required to provide adequate protection.

Phosgene oxime can be easily decontaminated with bleach, or caustic soda. The eyes can be decontaminated by treatment with excessive amounts of water, and saline solution. The skin can be decontaminated using bleach, alkali solutions, or the application of fuller's earth absorbent.

### **Mechanism of action**

In essence, the exact mechanisms of action upon the body are unknown. It is presumed that phosgene oxime reacts with the skin in a similar manner as stinging nettle or poison ivy, with irritation and pain being many times more severe. Tests have shown phosgene



## Chapter 7: Physical Nature of Blister agents

oxime reacts with proteins within the skin, and resulting irritation is the result of multiple reactions. In low concentrations, phosgene oxime stings the flesh like a bee sting, and in higher concentrations, it blisters the skin or causes welts. Phosgene oxime is very destructive to tissue because of its highly reactive chemical nature. Note: Very few compounds are as painful or irritating then phosgene oxime, and it is known as the most violent chemical warfare agent known.

### **Physical effects**

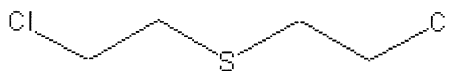
The eyes are affected by phosgene oxime resulting in corneal lesions and blindness. Exposure through inhalation can lead to pulmonary oedema of the respiratory tract. The skin is affected instantaneously upon contact producing an intense pain that radiates from the point of exposure, and within minutes the exposed area turns white and is surrounded by a zone of erythema. The overall area of exposure resembles a wagon wheel in appearance. Within 1 hour, the area becomes swollen and 24 hours the lesion turns yellow and blisters develop. Several days later, the same area shows desquamation with necrosis of the skin, which is followed by a crust and a purulent discharge.

### **Treatment**

The treatment of phosgene oxime burns is similar to fire burns, or wounds caused by mustards. Inhalation of the vapor should be treated by hospitalization so trained medical personnel can use appropriate action; as illnesses may vary. Treatment of inhalation exposures is similar to the arsenicals in nature. Pulmonary oedema should be treated accordingly. Infections are less common for phosgene oxime exposure, but antibacterials may be administered just for precautions. Morphine can be administered for relief of pain, and ointments of calamine, aloe Vera, or phenol can be directly applied to skin lesions for treatment.

# Chapter 8: Preparation of Blister Agents

## 03-001. Sulfur Mustard. Mustard gas. Kampfstoff. Yperite; 2,2'-Dichlorodiethyl sulfide; bis(beta-chloroethyl)sulfide



Mustard Gas

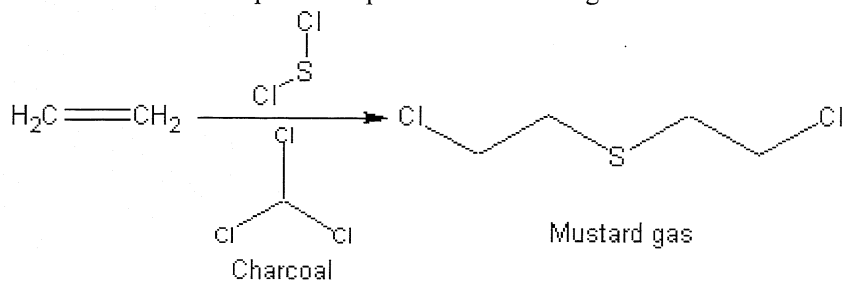
Mustard gas forms a colorless to yellowish to brown, oily liquid, which produces a colorless vapor. The vapor has a tendency to linger in low lining areas such as ditches, holes, trenches, and the like. The impure liquid has an odor of freshly cut mustards, hence the name. Pure mustard gas has a relatively mild sweet, agreeable odor, or no odor at all. Dangerous levels of mustard gas cannot be detected by the average soldier, even when the mustard gas is impure. It has a melting point of 14 Celsius, and a boiling point of 217 Celsius (begins to decompose from 150 to 170 Celsius); it can be distilled at 98 Celsius under a vacuum of 10 millimeters of mercury. Mustard gas is insoluble in water, but soluble in most organic solvents, and in lipids. It is volatile with steam, and can be steam distilled under normal conditions. Mustard gas is a suspected carcinogen, but this is of no importance due to its vesicant properties. Mustard gas is easily decomposed by alkalis, or by bleaching powder, and bleaching powder is the most effective material for its decomposition; ordinary bleach can be used as well. Because mustard gas has a high melting point, its use in cold climates has its disadvantages. Although, in dry cool climates, mustard gas can remain somewhat "dormant", until the temperature rises, whereupon the crystals of mustard gas change to liquid. This effect can be used to contaminate areas with mustard gas for up to 3 months under affluent conditions. During wet and warm conditions, mustard gas has very poor persistence, and may only last for up to 7 days under normal conditions; although, reports have indicated that dangerous levels of mustard gas can remain in said environments for up to 30 days. Mustard gas can be mixed with HN1, HN2, or HN3 for use in military operations. It may also be thickened by admixture with oils. Mustard gas is capable of producing violent burns and blisters to any exposed skin upon contact. The actual onset of burns and blisters can be delayed by up to 36 hours. Exposed personnel will be unaware of skin contact with said agent until it's too late. Blisters should be broken, and scrubbed immediately with bleaching powder, or bleach. All wounds should be treated immediately to prevent potential bacterial infections. Eye exposure to agent can lead to delayed illness including blindness. Mustard gas is less toxic, and less efficient than HN1, HN2, or HN3, and is no longer used by most modern militaries. Mustard gas can be disseminated using aerosols, explosives munitions, atomizers or humidifiers, or foggers. **Mustard gas is a moderate delayed action casualty producing agent capable of causing casualties within 4 to 24 hours after exposure. The lethal dose for 50% of population in rats through inhalation is 1500 to 3000 milligrams per kilogram. The lethal dose through inhalation by the average man may be as little as 1200 milligrams, but may be as high as 2 grams due to slow onset of symptoms. Mustard gas may cause severe illness if inhaled or ingested including violent coughing, choking, stomach disorders, digestive disorders, bleeding, and severe discomfort. Mustard gas on the skin can go unnoticed until symptoms are observed (4 to 24 hours). Skin exposure to as little as 100 milligrams can produce blisters within 32 hours exposure. Eye exposure to as little 100 to 200 milligrams may cause severe eye damage resulting in potential blindness.**

OVERALL RATING (scale from 1 to 10)	
<i>Effectiveness (as blister agent):</i> 8	<i>Field Stability:</i> 8
<i>Persistence (open area):</i> 8	<i>Storage stability:</i> 9
<i>Persistence (enclosed area):</i> 9	<i>Toxicity (as blister agent):</i> 7
<b>TOTAL EFFECTIVENESS (as blister agent): 8.1</b>	
<b>OVERALL TOXICITY (as warfare agent): 3½</b>	

### Procedure 3-001A: Preparation of Mustard gas (levinstein process)

**Summary:** Mustard gas is easily obtained by heating ethylene gas and sulfur dichloride under pressure. A small amount of activated charcoal is added to act as an inert carrier. After the reaction, the mixture is simply filtered, evaporated to remove the solvent, and then fractionally distilled to obtain a refined mustard gas product of purity averaging 90%.

Chapter 8: Preparation of Blister Agents



*Reaction Equation (by products omitted)*

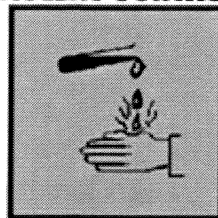
<b>Materials:</b>	1. 50 grams of dry ethylene gas	3. 200 milliliters of methylene chloride
	2. 72 grams of sulfur dichloride	4. 5 grams of activated charcoal

**Hazards:**



**WARNING!**

**VIOLENT CONTACT**



**HAZARD**

Do not attempt in anyway to prepare mustard gas using the following procedure unless proper safety precautions are taken. 1) Perform all operations in a clean box, in which is completely sealed from the air. Note: A clean box in this case is not needed. Mustard gas can be safely prepared as long as the maker wears proper gas mask, and nitrile gloves. 2) After each procedure, all glassware and non-electric equipment should be soaked in a bleach solution before removing from the clean box, and/or before rinsing and storing. Any electrical equipment that may be contaminated (even if suspected), such as hot plates and stirring equipment should be carefully wiped down with a rag soaked in bleach, followed by wiping down with hot water. 3) The desired mustard gas product should be stored in amber bottles, preferably non-breakable containers, and stored in a cool dry place away from sunlight. The bottles should also be placed inside an airtight sealed plastic bag, such as a 'ziplock' bag. 4) Storage of any blister agent should be in airtight cabinets, drawers, or the like, and said storage spaces should be equipped with chemical agent detection monitors to alert of any potential leakage.

Use caution when handling sulfur dichloride, which reacts with water yielding toxic and corrosive vapors. Extinguish all flames before using ethylene gas, which is highly flammable.

**Procedure:** Assemble the apparatus illustrated in 038, and then fill the reaction flask with 200 milliliters of methylene chloride, 5 grams of activated charcoal, followed by 72 grams of sulfur dichloride. Then begin the nitrogen purge, and thereafter, bring the mixture to a reflux at about 60 Celsius, and when the temperature reaches 60 Celsius, begin rapidly bubbling a total of 50 grams of ethylene gas into the reaction mixture while stirring the reaction mixture, and maintaining its temperature at 60 Celsius. The ethylene gas addition should take no more then 3 hours. After the addition, continue to reflux the reaction mixture at 60 Celsius while vigorously stirring for an additional 30 minutes. After 30 minutes, remove the heat source and allow the reaction mixture to cool to room temperature. Thereafter, filter-the reaction mixture to remove any insoluble materials, and then place the filtered reaction mixture into a rotary evaporator or vacuum distillation apparatus, and remove the methylene chloride under vacuum. When all the methylene chloride has been removed, remove the remaining residue, and then place it into a clean vacuum distillation apparatus, and fractionally distil the mustard gas at 98 Celsius under a vacuum of 10 millimeters of mercury to obtain a refined mustard gas product of purity from 85% to 98%. Further purification is technically not needed for use in military operations, but can be achieved through a second vacuum distillation.

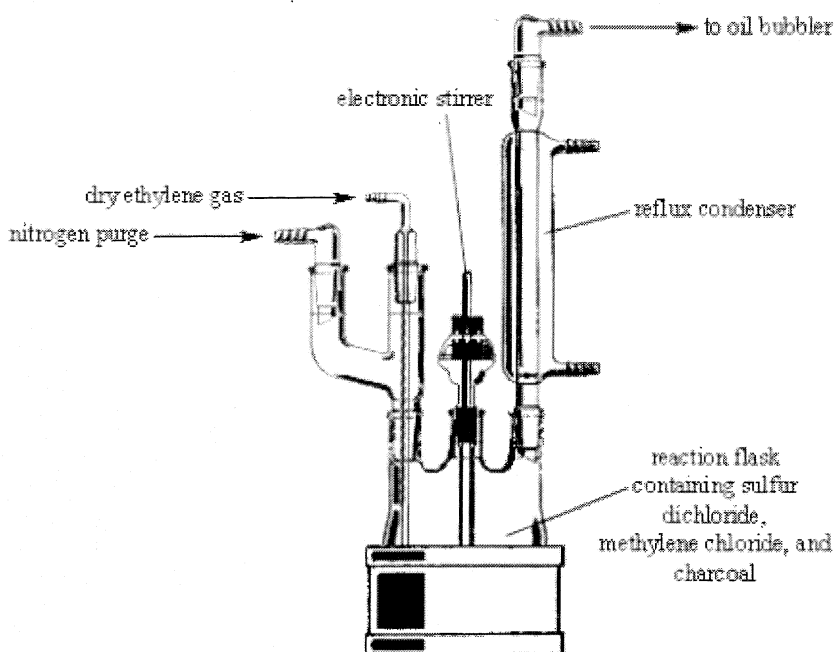
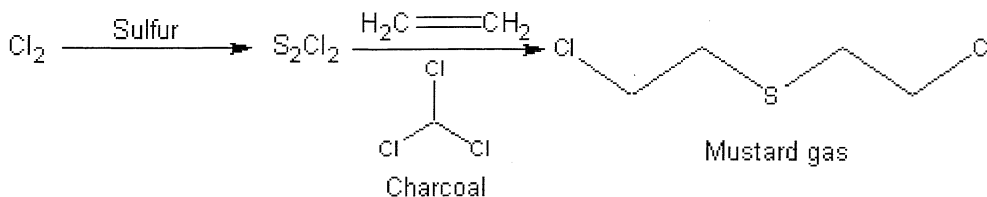


Figure 038. Setup for ethylene gas addition.

**Procedure 3-001B: Preparation of Mustard gas (modified levinstein process)**

**Summary:** Mustard gas is easily prepared by using a modified levinstein process. In this process, sulfur and chlorine are reacted to produce sulfur monochloride, which is then reacted with dry ethylene gas in the presence of activated charcoal. All reactions take place in methylene chloride, and under reflux conditions at 60 Celsius. After the ethylene gas addition, the reaction mixture is filtered, evaporated to drive off the solvent, and then fractionally distilled to give a refined mustard gas product of an average purity of 90%, well suitable for use in chemical warfare munitions.



*Reaction Equation (by products omitted)*

<b>Materials:</b>	1. 49 grams of dry ethylene gas	4. 5 grams of activated charcoal
	2. 45 grams of powdered sulfur	5. 50 grams of dry chlorine gas
	3. 250 milliliters of methylene chloride	

**Hazards:**



Do not attempt in anyway to prepare mustard gas using the following procedure unless proper safety precautions are taken. 1) Perform all operations in a clean box, in which is completely sealed from the air. Note: A clean box in this case is not needed. Mustard gas can be safely prepared as long as the maker wears proper gas mask, and nitrile gloves.

## Chapter 8: Preparation of Blister Agents

2) After each procedure, all glassware and non-electric equipment should be soaked in a bleach solution before removing from the clean box, and/or before rinsing and storing. Any electrical equipment that may be contaminated (even if suspected), such as hot plates and stirring equipment should be carefully wiped down with a rag soaked in bleach, followed by wiping down with hot water. 3) The desired mustard gas product should be stored in amber bottles, preferably non-breakable containers, and stored in a cool dry place away from sunlight. The bottles should also be placed inside an airtight sealed plastic bag, such as a 'ziplock' bag. 4) Storage of any blister agent should be in airtight cabinets, drawers, or the like, and said storage spaces should be equipped with chemical agent detection monitors to alert of any potential leakage.

Use caution when handling chlorine gas, which is toxic, and very irritating. Ethylene gas is highly flammable, so extinguish all flames before using.

**Procedure:** Into a suitable flask, place 250 milliliters of methylene chloride, followed by 45 grams of powdered sulfur. Then assemble the left apparatus in figure 039. Thereafter, rapidly bubble 50 grams of dry chlorine gas into the methylene chloride/sulfur mixture while stirring the methylene chloride/sulfur mixture, and maintaining its temperature at room temperature. The addition of the chlorine should not take longer than 6 hours. After the addition of the chlorine, reflux the reaction mixture at 60 Celsius for 30 minutes. Thereafter, quickly allow the reaction mixture to cool to room temperature, and then quickly add in 5 grams of charcoal. Then, assemble the apparatus in the right illustration of figure 039, and then start the nitrogen purge. Then bring the reaction mixture back to reflux at 60 Celsius. Thereafter, rapidly bubble 49 grams of dry ethylene gas into the reaction mixture while rapidly stirring the reaction mixture and maintaining its temperature at 60 Celsius. The addition of the ethylene gas should take no longer than 3 hours. After the addition of the ethylene gas, continue to reflux the reaction mixture at 60 Celsius for 30 minutes. Thereafter, remove the heat source, and allow the reaction mixture to cool to room temperature. Then filter the reaction mixture to remove any insoluble materials, and then place the filtered reaction mixture into a rotary evaporator or vacuum distillation apparatus, and remove the methylene chloride under vacuum. When all the methylene chloride has been removed, remove the remaining residue, and place into clean vacuum distillation apparatus, and fractionally distill the mustard gas at 98 Celsius under a vacuum of 10 millimeters of mercury to obtain a refined mustard gas product of 85 to 98% purity. Further purification is technically not needed for use in military operations, but can be achieved through a second vacuum distillation.

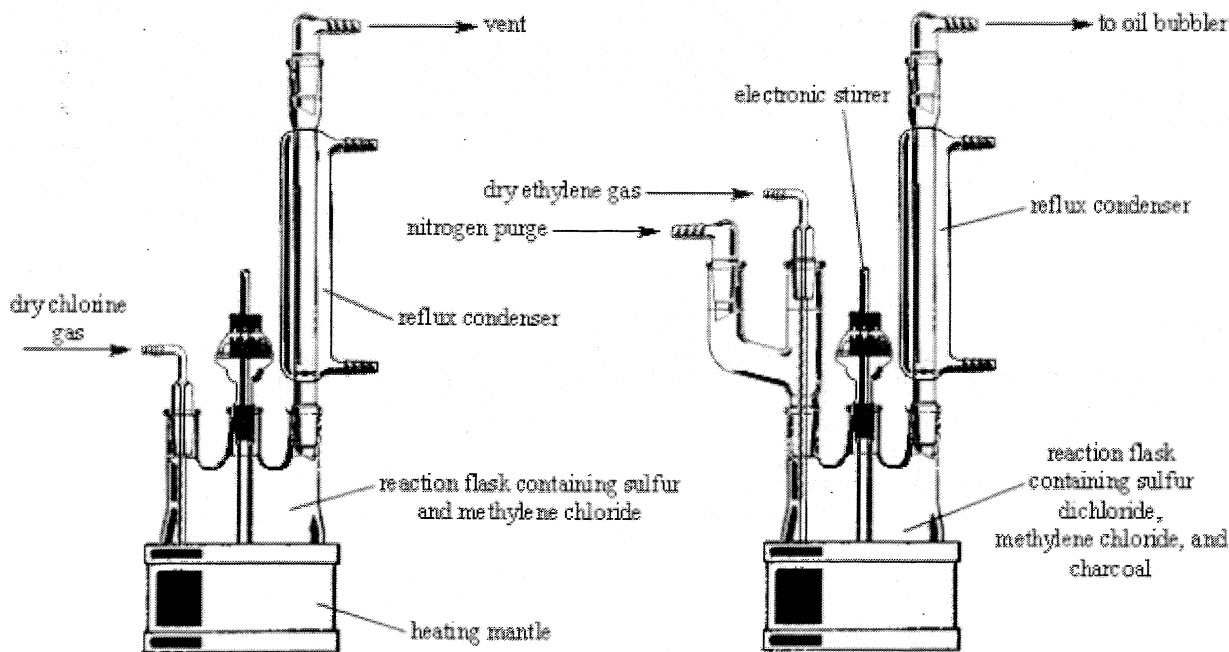
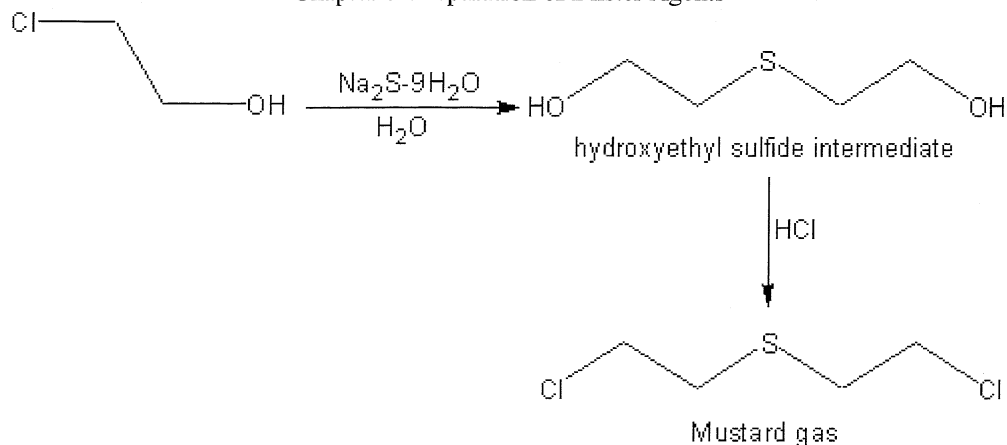


Figure 039. Left illustration: reaction of sulfur with chlorine. Right illustration: ethylene gas addition.

### Procedure 3-001C: Preparation of Mustard gas (sodium sulfide process)

**Summary:** Mustard gas can be prepared in a two step process starting with the formation of bis(hydroxyethyl)sulfide. This hydroxyethyl sulfide intermediate is easily prepared by reacting water solutions of sodium sulfide and ethylene chlorohydrin. The resulting hydroxyethyl sulfide intermediate is then converted into mustard gas by the addition of concentrated hydrochloric acid. Upon the addition of the hydrochloric acid, the mustard gas will separate as a viscous oil. The mustard gas is then removed using a separatory funnel, and then fractionally distilled under vacuum to obtain a refined mustard gas product with an average purity of 95%.

Chapter 8: Preparation of Blister Agents



*Reaction Equation (by products omitted)*

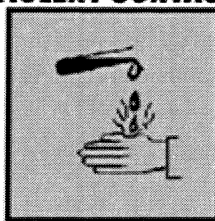
<b>Materials:</b>	1. 60 grams of ethylene chlorohydrin	3. 75 grams of 35 to 38% hydrochloric acid
	2. 89 grams of sodium sulfide nonahydrate	

**Hazards:**



**WARNING!**

**VIOLENT CONTACT**



**HAZARD**

Do not attempt in anyway to prepare mustard gas using the following procedure unless proper safety precautions are taken. 1) Perform all operations in a clean box, in which is completely sealed from the air. Note: A clean box in this case is not needed. Mustard gas can be safely prepared as long as the maker wears proper gas mask, and nitrile gloves. 2) After each procedure, all glassware and non-electric equipment should be soaked in a bleach solution before removing from the clean box, and/or before rinsing and storing. Any electrical equipment that may be contaminated (even if suspected), such as hot plates and stirring equipment should be carefully wiped down with a rag soaked in bleach, followed by wiping down with hot water. 3) The desired mustard gas product should be stored in amber bottles, preferably non-breakable containers, and stored in a cool dry place away from sunlight. The bottles should also be placed inside an airtight sealed plastic bag, such as a 'ziplock' bag. 4) Storage of any blister agent should be in airtight cabinets, drawers, or the like, and said storage spaces should be equipped with chemical agent detection monitors to alert of any potential leakage.

Use caution when handling ethylene chlorohydrin, and sodium sulfide nonahydrate, both of which are irritating and corrosive. Sodium sulfide is flammable, so extinguish all flames before using. Hydrochloric acid is very corrosive, use caution when handling.

**Procedure:** Into a suitable reaction flask, add 89 grams of sodium sulfide nonahydrate, and then add 100 milliliters of water. Then stir the mixture to dissolve all solids. Then prepare a second solution by adding and dissolving 60 grams of ethylene chlorohydrin into 60 milliliters of water. Then place this ethylene chlorohydrin solution into an addition funnel, and attach this addition funnel to the reaction flask containing the sodium sulfide. Thereafter, add drop wise, the ethylene chlorohydrin solution to the sodium sulfide solution while vigorously stirring the sodium sulfide solution, and maintaining its temperature at room temperature. Note: a cold-water bath may or may not be needed to keep the sodium sulfide solution properly cooled. After the addition of the ethylene chlorohydrin solution, heat the reaction mixture for 1 hour at 50 to 60 Celsius with vigorous stirring. After heating for 1 hour, remove the heat source, and allow the reaction mixture to cool to room temperature. Then filter the reaction mixture to remove any solid impurities, and then place the filtered reaction mixture back into the reaction flask, and place it into a cold-water bath. Then replace the addition funnel used for the ethylene chlorohydrin addition with a clean addition funnel. Then place 75 grams of a 35 to 38% hydrochloric acid solution into this addition funnel. Then gradually add the hydrochloric acid solution over a period sufficient to keep the reaction mixture below 30 Celsius. After the addition, heat the mixture to 50 to 60 Celsius for 1 hour with vigorous stirring. Then allow the reaction mixture to cool to room temperature, and then remove the lower mustard gas layer using a separatory funnel, or by

decantation. Thereafter, quickly filter the mustard gas layer, and then place it into a vacuum distillation apparatus, and fractionally distill the mustard gas at 98 Celsius, and under a vacuum of 10 millimeters of mercury to obtain a refined mustard gas product of 90 to 98% purity. Further purification is technically not needed for use in military operations, but can be achieved through a second vacuum distillation.

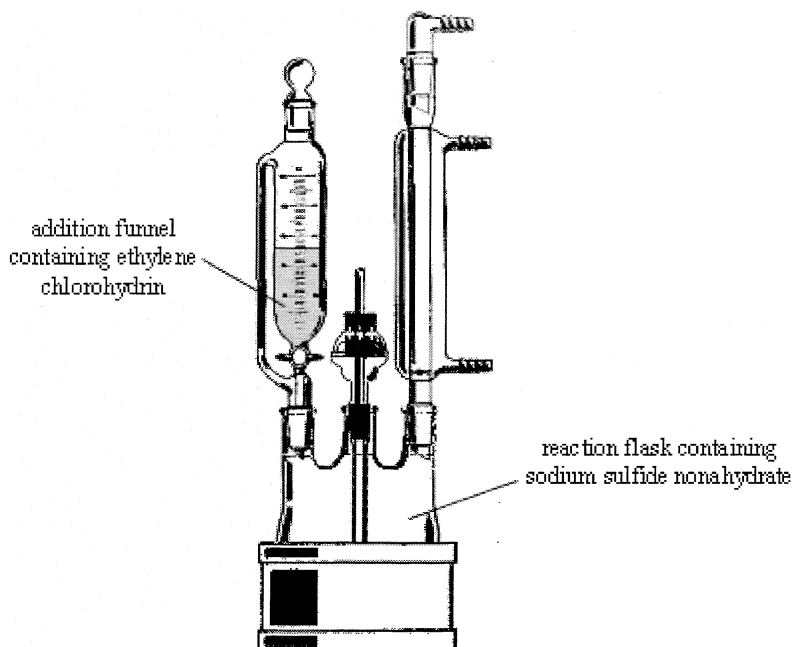
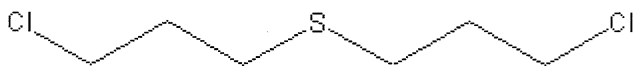


Figure 040. Apparatus for the preparation of mustard gas.

### 03-002. Sulfur Mustard-II. Mustard gas II. *2,2'-Dichlorodipropyl sulfide; bis(beta-chloropropyl)sulfide*



Mustard gas II

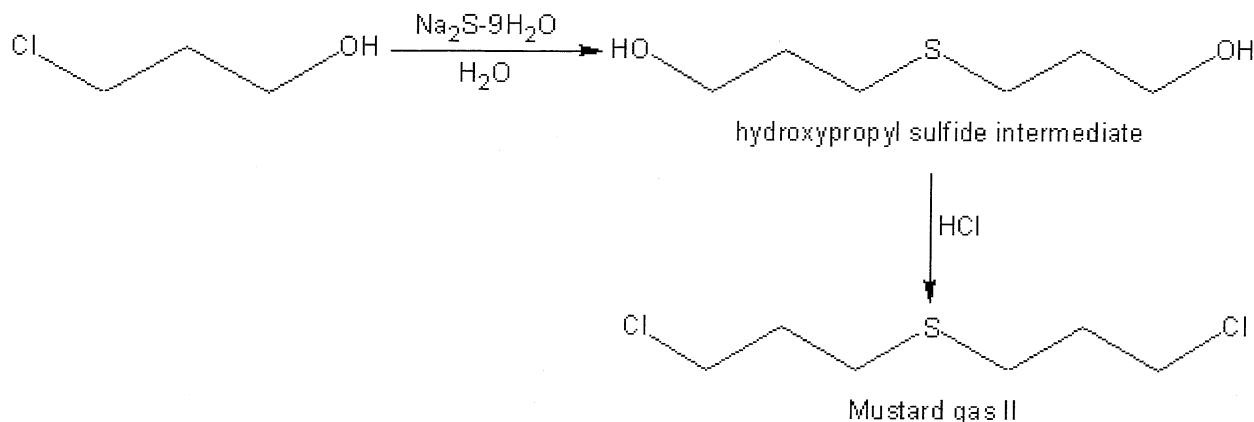
Mustard gas II has similar properties as the original mustard gas. Little data is known on this substance but it appears to be a colorless to brownish solid, or colorless to brownish semi viscous liquid. In most cases, the pure compound is probably a solid with a melting point ranging from 20 to 40 Celsius. The impure compound is most likely a semi liquid, viscous oil. The odor of mustard gas II would be anywhere from a faint spicy odor, to a weak or mild, pleasant odor. Mustard gas II is probably slightly more stable than mustard gas, but its environmental persistence would not be much greater. It could be disseminated using aerosols, explosives munitions, atomizers or humidifiers, or foggers. Mustard gas II could be used in combination with mustard gas, or admixed with HN1, HN2, or HN3 for use in military operations with satisfactory results. Straight mustard gas II could be used to contaminate areas for up to 2 weeks, depending on environmental conditions. As with mustard gas, it would show little effect in cold and wet climates, but in warm and dry climates, it would have excellent results. Mustard gas II would linger for longer periods of time in low lying areas such as bunkers, tunnels, holes, and ditches than the original mustard would. As with original mustard, it would be easily decontaminated with bleaching powder, or with ordinary liquid bleach. Large areas contaminated with mustard gas II would be difficult to decontaminate, and hence, mustard gas II could be used as a "road block", or other form of "deterrent" to halt enemy advancements. Mustard gas II would have a slight longer delay action than original mustard, and would show signs of its presence 6 to 36 hours after exposure to such agent. Areas of skin that are contacted will develop blisters and burns similar in nature as to original mustard. Exposure of the agent to the eyes, nose, and throat, would most likely produce delayed effects as well. Inhalation or ingestion of the agent may lead to series coughing, choking, lung distress, bleeding, and other severe illnesses within 36 hours of exposure. Inhalation of mustard gas II may go unnoticed for up to 32 hours, where after serious lung illness would begin, leading to fluid buildup in the lungs, violent coughing, and potential bleeding. As with original mustard gas, the liquid within the blisters would be poisonous as well, and all blisters should be decontaminated immediately to prevent the potential formation of bacterial infections after onset. **Lethal dose for 50% of population in mice (inhalation): 1300 to 3500 milligrams per kilogram of body weight. The lethal dose through inhalation in the average man may be as high as 2 grams due to slow rates of onset. Mustard gas II is a mild, delayed action casualty producing agent capable of producing casualties with 36 hours of exposure. Skin exposure to as little as 100**

milligrams can produce blisters within 32 hours of exposure. Eye exposure to as little 100 to 200 milligrams may cause severe eye damage resulting in potential blindness.

OVERALL RATING (scale from 1 to 10)	
Effectiveness (as blister agent): 7	Field Stability: 9
Persistence (open area): 9	Storage stability: 9
Persistence (enclosed area): 10	Toxicity (as blister agent): 7½
TOTAL EFFECTIVENESS (as blister agent): 8.5	
OVERALL TOXICITY (as warfare agent): 3½	

### Procedure 3-002A: Preparation of Mustard gas II (sodium sulfide process)

**Summary:** Mustard gas II can be prepared in a two step process starting with the formation of bis(hydroxypropyl)sulfide. This hydroxypropyl sulfide intermediate is easily prepared by reacting water solutions of sodium sulfide and propylene chlorohydrin. The resulting hydroxypropyl sulfide intermediate is then converted into mustard gas II by the addition of concentrated hydrochloric acid. Upon the addition of the hydrochloric acid, the mustard gas II will separate as semi solid, viscous oil, or crystalline solid. The mustard gas II is then removed either by using a separatory funnel, or by filtration, and the collected mustard gas II is then fractionally distilled under high vacuum to obtain a refined mustard gas II product with an average purity of 90 to 95%.



#### Reaction Equation (by products omitted)

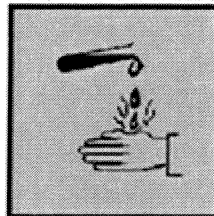
<b>Materials:</b>	1. 77 grams of propylene chlorohydrin	3. 82 grams of 35 to 38% hydrochloric acid
	2. 97 grams of sodium sulfide nonahydrate	

#### Hazards:



**WARNING!**

#### VIOLENT CONTACT



**HAZARD**

Do not attempt in anyway to prepare mustard gas II using the following procedure unless proper safety precautions are taken. 1) Perform all operations in a clean box, in which is completely sealed from the air. Note: A clean box in this case is not needed. Mustard gas II can be safely prepared as long as the maker wears proper gas mask, and nitrile gloves. 2) After each procedure, all glassware and non-electric equipment should be soaked in a bleach solution before removing from the clean box, and/or before rinsing and storing. Any electrical equipment that may be contaminated (even if suspected), such as hot plates and stirring equipment should be carefully wiped down with a rag soaked in bleach, followed by wiping down with hot water. 3) The desired mustard gas II product should be stored in amber bottles, preferably non-breakable containers, and stored in a cool dry place away from sunlight. The bottles should also be placed inside an airtight sealed plastic bag, such as a 'ziplock' bag. 4) Storage of any blister agent should be in airtight cabinets, drawers, or the like, and said storage spaces should be equipped with chemical agent detection



monitors to alert of any potential leakage.

Use caution when handling propylene chlorohydrin, and sodium sulfide nonahydrate, both of which are irritating and corrosive. Sodium sulfide is flammable, so extinguish all flames before using. Hydrochloric acid is very corrosive, use caution when handling.

**Procedure:** Into a suitable reaction flask, add 97 grams of sodium sulfide nonahydrate, and then add 120 milliliters of water. Then stir the mixture to dissolve all solids. Then prepare a second solution by adding and dissolving 77 grams of propylene chlorohydrin into 80 milliliters of water. Then place this propylene chlorohydrin solution into an addition funnel, and attach this addition funnel to the reaction flask containing the sodium sulfide. Thereafter, add drop wise, the propylene chlorohydrin solution to the sodium sulfide solution while vigorously stirring the sodium sulfide solution, and maintaining its temperature at room temperature. Note: a cold-water bath may or may not be needed to keep the sodium sulfide solution properly cooled. After the addition of the propylene chlorohydrin solution, heat the reaction mixture for 1 hour at 60 to 70 Celsius with vigorous stirring. After heating for 1 hour, remove the heat source, and then filter the reaction mixture hot (to remove any solid impurities). Then allow the filtered reaction mixture to cool to room temperature, and then place the filtered reaction mixture back into the reaction flask, and place it into a cold-water bath. Then replace the addition funnel used for the propylene chlorohydrin addition with a clean addition funnel. Then place 82 grams of a 35 to 38% hydrochloric acid solution into this addition funnel. Then gradually add the hydrochloric acid solution over a period sufficient to keep the reaction mixture below 30 Celsius. After the addition, heat the reaction mixture to 60 to 70 Celsius for 1 hour with vigorous stirring. Then allow the reaction mixture to cool to room temperature, and then place the reaction mixture into an ice bath, and chill to 5 Celsius. Thereafter, filter-off the crystalline mustard gas II, and then vacuum dry or air-dry the solid. Note: in some cases the mustard gas II may be a viscous liquid. If this is the case, use a separatory funnel to remove the mustard gas II layer; the mustard gas II will be the bottom layer. Thereafter, if the mustard gas II was removed as a viscous liquid, quickly filter the mustard gas layer. Thereafter, place the mustard gas II, either crystalline or liquid, into a vacuum distillation apparatus, and fractionally distill the mustard gas II under high vacuum, and under a temperature of 150 Celsius to obtain a refined mustard gas II product of 90 to 98% purity.

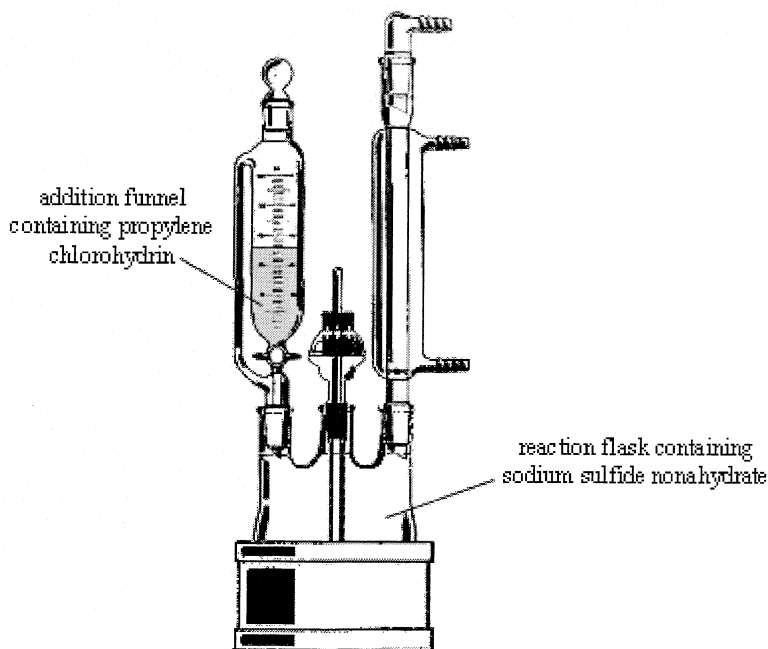
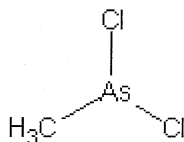


Figure 041. Setup for preparation of mustard gas II.

### 03-003. MD. Methyldichloroarsine



MD

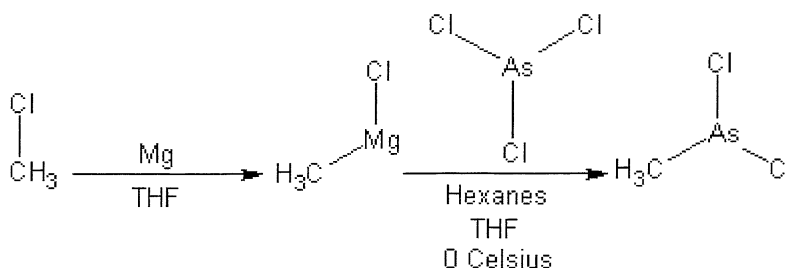
### Chapter 8: Preparation of Blister Agents

Methyldichloroarsine forms a colorless, odorless liquid. It has a melting point of -55 Celsius, and a boiling point of 133 Celsius. It begins to decompose around 130 Celsius, but can be easily distilled below 100 Celsius under vacuum. Methyldichloroarsine is very similar to ethyldichloroarsine, and it can be admixed with ethyldichloroarsine for use in military operations where irritating and biting effects are desired. As with ethyldichloroarsine, it produces almost immediate irritation upon skin contact and inhalation. Its persistence in the environment may only be up to 3 days under normal conditions, but reports have stated its persistence to be up to 12 days under normal environmental conditions (warm and dry environments). Skin exposure to liquid or vapor may develop blisters within 32 hours of exposure, but blister formation is rare due its immediate irritation upon skin contact (easily alerts exposed personnel to its presence). Note: Methyldichloroarsine is capable of penetrating rubber, rendering some gas masks ineffective. It can be disseminated through aerosols, explosives munitions, atomizers or humidifiers, or foggers. **Methyldichloroarsine is a moderate fast acting blister agent capable of producing casualties within minutes of dissemination. Blister formation is delayed by up to 32 hours. The lethal dose in the average man through inhalation may be as high 1000 to 4000 milligrams. As little as 50 milligrams on the skin may produce irritation. Inhalation of the agent may cause lung illnesses, and systematic poisoning. Skin absorption of as little as 500 micromilliliters may lead to bodily organ damage and systematic poisoning. Methyldichloroarsine is easily decontaminated with bleaching powder or bleach.**

OVERALL RATING (scale from 1 to 10)	
<i>Effectiveness (as blister agent):</i> 6	<i>Field Stability:</i> 7
<i>Persistence (open area):</i> 7	<i>Storage stability:</i> 8
<i>Persistence (enclosed area):</i> 8	<i>Toxicity (as blister agent):</i> 6½
<b>TOTAL EFFECTIVENESS (as blister agent):</b> 7	
<b>OVERALL TOXICITY (as warfare agent):</b> 3½	

### Procedure 3-003A: Preparation of Methyldichloroarsine

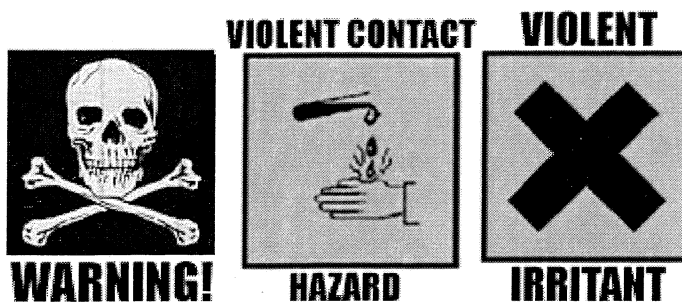
**Summary:** Methyldichloroarsine is prepared in a two-stop process starting with the formation of methylmagnesium chloride. Methylmagnesium chloride is prepared by the reaction between methyl chloride and magnesium turnings in tetrahydrofuran. The resulting tetrahydrofuran solution containing the methylmagnesium chloride is then treated with a solution of arsenic trichloride in hexanes. The resulting reaction mixture is then evaporated to remove the solvents, and the methyldichloroarsine is then recovered by fractional distillation.



*Reaction Equation (by products omitted)*

<b>Materials:</b>	1. 37 grams of methyl chloride (lecture bottle or liquid)	4. 132 grams of anhydrous arsenic trichloride
	2. 17.8 grams magnesium turnings	5. 500 milliliters of hexanes
	3. 200 milliliters of tetrahydrofuran	

#### Hazards:



Do not attempt in anyway to prepare methyldichloroarsine using the following procedure unless proper safety precautions are taken. 1) Perform all operations in a clean box, in which is completely sealed from the air. Note: A clean box in this case is not needed. Methyldichloroarsine can be safely prepared as long as the maker wears proper

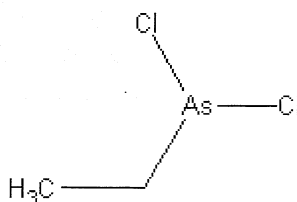
## Chapter 8: Preparation of Blister Agents

gas mask, and nitrile gloves. 2) After each procedure, all glassware and non-electric equipment should be soaked in bleach before removing from the clean box, and/or before rinsing and storing. Any electrical equipment that may be contaminated (even if suspected), such as hot plates and stirring equipment should be carefully wiped down with a rag soaked in bleach followed by wiping down with hot water. 3) The desired methylchloroarsine product should be stored in amber bottles, preferably non-breakable containers, and stored in a cool dry place away from sunlight. The bottles should also be placed inside an airtight sealed plastic bag, such as a 'ziplock' bag. 4) Storage of any and all blister agents should be in airtight cabinets, drawers, or the like, and said storage spaces should be equipped with chemical agent detection monitors to alert of any potential leakage.

Use caution when handling arsenic trichloride, which is very toxic, and can be absorbed through the skin. Extinguish all flames before using methyl chloride and tetrahydrofuran, both of which are highly flammable. Make sure to perform the peroxide test before using tetrahydrofuran (which has been in storage for sometime). Use caution when handling methylmagnesium chloride, which may ignite spontaneously if exposed to air over a wide surface area (i.e., a rag soaked in a solution of methylmagnesium chloride and tetrahydrofuran will begin to smoke, and then catch fire when exposed to air).

**Procedure:** Into a suitable flask, place 200 milliliters of anhydrous tetrahydrofuran, and then add 37 grams of methyl chloride. Note: you can either bubble the methyl chloride gas into the tetrahydrofuran, or add in 37 grams of liquid methyl chloride. Thereafter, slowly add 17.8 grams of magnesium turnings to the tetrahydrofuran/methyl chloride mixture while stirring the tetrahydrofuran/methyl chloride mixture and maintaining its temperature below 60 Celsius. Note: During the magnesium addition, the temperature will rise to about 60 Celsius. Don't let the temperature rise above 60 Celsius. After the addition of the magnesium, briefly stir the reaction mixture for about 5 minutes, and then place the reaction mixture into an ice bath and chill to 0 Celsius. Immediately when the temperature of the reaction mixture reaches 0 Celsius, carefully add drop wise, a solution prepared by adding 132 grams of arsenic trichloride into 500 milliliters of hexanes. During the arsenic trichloride/hexanes addition, vigorously stir the reaction mixture while keeping its temperature at 0 Celsius at all times. After the addition of the arsenic trichloride/hexanes mixture, vigorously stir the reaction mixture at 0 Celsius for 2 hours. After 2 hours, carefully add in 100 milliliters of cold water (to dissolve the magnesium chloride), and then briefly stir the reaction mixture for about 10 minutes. Immediately thereafter, place the entire mixture into a separatory funnel, and remove the lower organic layer. Then quickly filter this lower organic layer to remove any insoluble impurities, and then place this organic layer into a rotary evaporator, or vacuum distillation apparatus, and remove the hexanes and any tetrahydrofuran solvent under vacuum. When the solvents have been removed, place the remaining liquid into a clean vacuum distillation apparatus, and fractionally distill the methylchloroarsine under vacuum and under a temperature of 100 Celsius to obtain a purified methylchloroarsine product. Note: Dimethylchloroarsine and trimethylarsine will be obtained in small quantities as by-products.

### 03-004. ED. Ethylchloroarsine



ED

Ethylchloroarsine is similar to methylchloroarsine and lewisite. It's a highly irritating colorless to dark brown liquid with a boiling point of 156 Celsius (with decomposition starting at said temperature). It can easily be distilled at 83 Celsius under a vacuum of 75 millimeters of mercury, where it distills over as a water-white liquid. It has a rather fruity yet biting and penetrating odor. Pure ethylchloroarsine may have a slight odor of apples/bananas/pears, but the military grade ethylchloroarsine has a rather irritating and penetrating odor. The melting point of ethylchloroarsine is -65 Celsius, making it well suitable for use in cold weather climates. Ethylchloroarsine can be used as a military war gas due to its highly irritating nature. Like lewisite, it is capable of forming blisters on the skin within 32 hours of exposure. Inhalation of the vapor produces severe irritation of the nose, and throat leading to severe coughing, and lung distress. Inhalation of the vapor may cause death. Ethylchloroarsine produces immediate pain upon inhalation, and hence, gives rise to its presence. In some cases, its presence may not be easily detected by mere inhalation along. The liquid on the skin produces immediate irritation, but blister formation is delayed by up to 32 hours. Due to immediate irritation upon contact, blisters can be easily avoided due to immediate decontamination. Ethylchloroarsine can be used in military operations where it is desired to incapacitate personnel. It is seldom fatal, and only exposed personnel to the agent in closed environments without proper protection are likely to be killed. Ethylchloroarsine is readily volatile, and it yields a colorless vapor upon volatilization. The agent will linger in low lining areas during the nighttime, and will volatilize into a vapor, which lingers in higher lining areas during the day. The persistence of ethylchloroarsine may be up to 7 days under warm and dry conditions. Note: Ethylchloroarsine is capable of

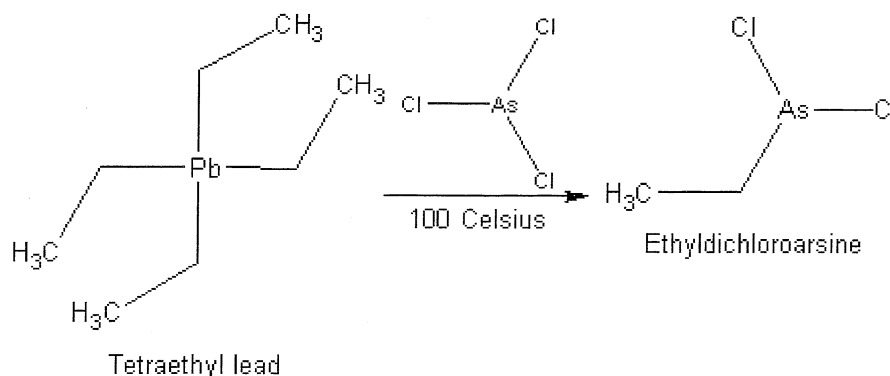
Chapter 8: Preparation of Blister Agents

penetrating rubber, rendering some gas masks ineffective. It can be disseminated through aerosols, explosives munitions, atomizers or humidifiers, or foggers. **ED is a moderately fast acting blister agent capable of producing casualties within minutes of exposure. The agent produces immediate irritation when inhaled, ingested, or upon skin contact or eye contact. Blisters will form within 32 hours of skin exposure. Inhalation and skin absorption can lead to systematic poisoning within 4 hours of exposure. Exposure of the vapor to the eyes causes immediate irritation and pain. Over exposure of the vapor to the eyes can lead to blindness. Chronic exposure to low concentrations can lead to lung illnesses, and damage to bodily organs. Lethal dose through inhalation in the average man ranges from 900 to 4000 milligrams. Concentration of vapor or liquid as low as 5 milligrams may cause irritation upon eye exposure, and 50 milligrams upon the skin may cause skin irritation. As little as 500 micromilliliters may suffice to produce blisters within 32 hours of exposure. Ethyldichloroarsine is readily decontaminated with bleaching powder or bleach.**

OVERALL RATING (scale from 1 to 10)	
<i>Effectiveness (as blister agent): 8</i>	<i>Field Stability: 8</i>
<i>Persistence (open area): 7</i>	<i>Storage stability: 8</i>
<i>Persistence (enclosed area): 8</i>	<i>Toxicity (as blister agent): 7</i>
<b>TOTAL EFFECTIVENESS (as blister agent): 7.6</b>	
<b>OVERALL TOXICITY (as warfare agent): 3½</b>	

**Procedure 3-004A: Preparation of Ethyldichloroarsine**

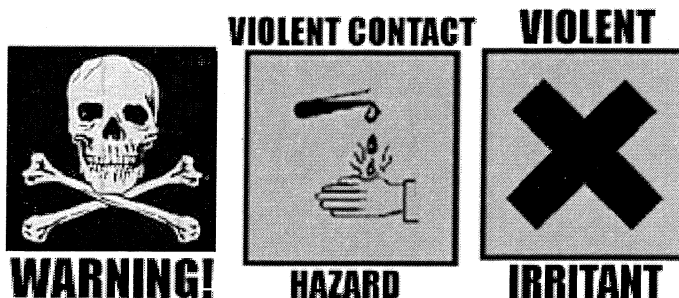
**Summary:** Ethyldichloroarsine is readily prepared by refluxing tetraethyl lead with arsenic trichloride. The reaction must be maintained at about 100 Celsius to keep the formation of diethylchloroarsine from forming. After the reaction, the reaction mixture is distilled under vacuum to obtain a ethyldichloroarsine product of about 95% purity. The 95% pure ethyldichloroarsine can then be purified by fractional distillation if desired. Note: The preparation of ethyldichloroarsine discussed in this procedure is similar or related to the process discussed in serial number 291,054 May 15<sup>th</sup>, 1952 by Morris S. Kharasch, Chicago, ILL; and Sidney Weinhouse, Chester, Pa; assigned by The United States Army. This process may be protected by industrial/commercial process applications. Consult said application number before using the mentioned process for commercial or industrial purposes.



*Reaction Equation (by products omitted)*

<b>Materials:</b> 1. 81 grams of tetraethyl lead	2. 136.5 grams of anhydrous arsenic trichloride
--	---

**Hazards:**



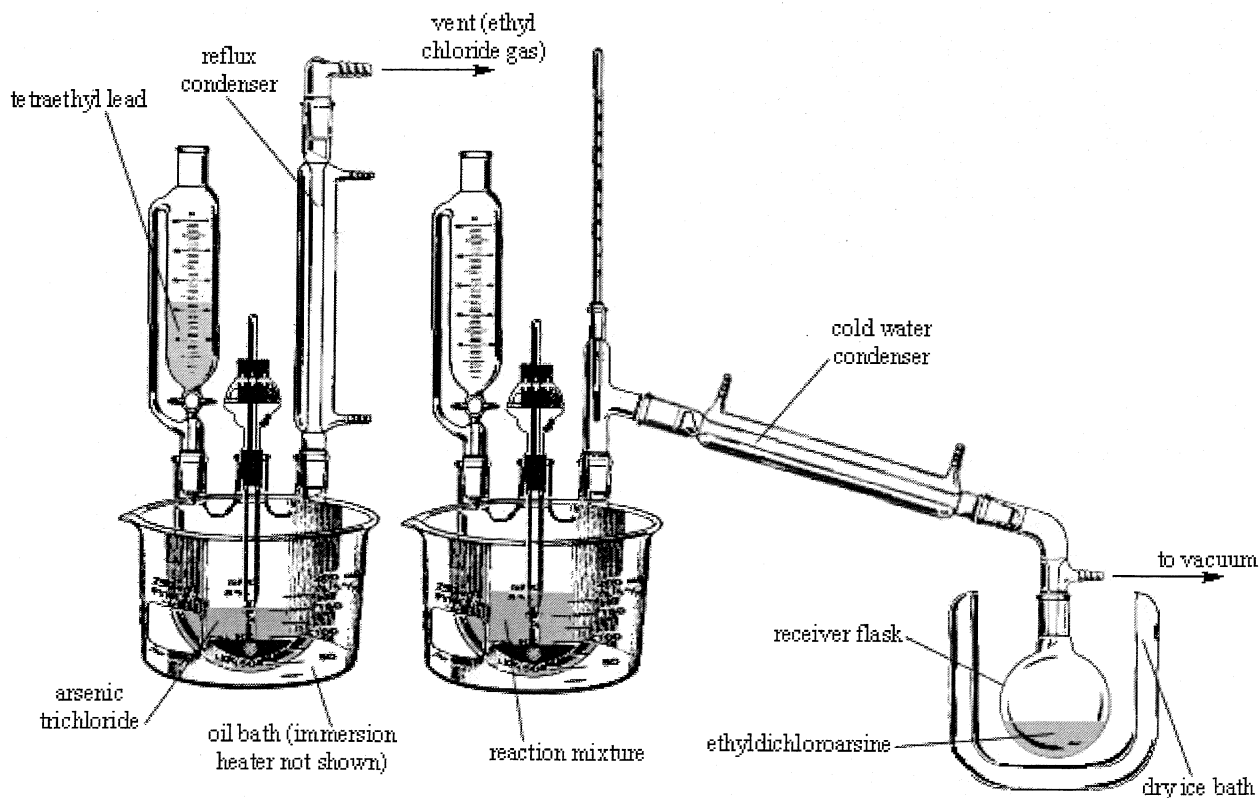
Do not attempt in anyway to prepare ethyldichloroarsine using the following procedure unless proper safety precautions are taken. 1) Perform all operations in a clean box, in which is completely sealed from the air. Note: A

## Chapter 8: Preparation of Blister Agents

clean box in this case is not needed. Ethyldichloroarsine can be safely prepared as long as the maker wears proper gas mask, and nitrile gloves. 2) After each procedure, all glassware and non-electric equipment should be soaked in bleach before removing from the clean box, and/or before rinsing and storing. Any electrical equipment that may be contaminated (even if suspected), such as hot plates and stirring equipment should be carefully wiped down with a rag soaked in bleach followed by wiping down with hot water. 3) The desired ethyldichloroarsine product should be stored in amber bottles, preferably non-breakable containers, and stored in a cool dry place away from sunlight. The bottles should also be placed inside an airtight sealed plastic bag, such as a 'ziplock' bag. 4) Storage of any and all blister agents should be in airtight cabinets, drawers, or the like, and said storage spaces should be equipped with chemical agent detection monitors to alert of any potential leakage.

Use caution when handling arsenic trichloride, which is very toxic, and can be absorbed through the skin. Note: During the reaction, flammable ethyl chloride gas is evolved, extinguish all flames before carrying out the reaction.

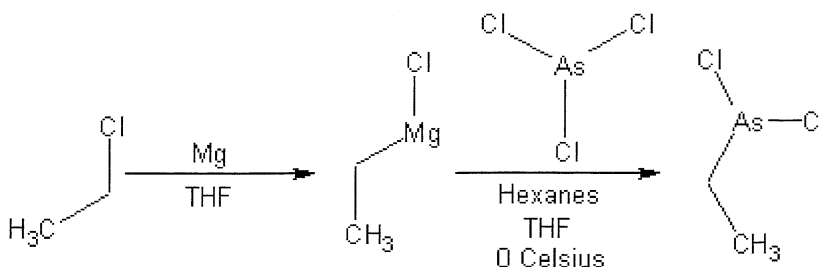
**Procedure:** Into a suitable flask equipped with an electric stirrer, reflux condenser, and gas inlet tube, place 136.5 grams of arsenic trichloride. Thereafter, begin a nitrogen purge to sweep the air out of the apparatus, and continue the nitrogen purge for about 4 minutes to flush all the air out of the apparatus. Then remove the nitrogen purge and the gas inlet tube, and replace with an addition funnel. Then place the reaction flask into an oil bath, and heat to 100 Celsius. When the temperature of the arsenic trichloride reaches 100 Celsius, place 81 grams of tetraethyl lead into the addition funnel, and then add a few milliliters of this tetraethyl lead to the arsenic trichloride. During the addition, rapidly stir the arsenic trichloride. Shortly after the addition of the few milliliters of tetraethyl lead, a white cloudy appearance will form in the arsenic trichloride. After the addition, wait a few minutes, and then gradually add the rest of the tetraethyl lead over a period of time as to maintain the reaction mixtures temperature at 100 Celsius (do not exceed 100 Celsius). During the addition, rapidly stir the arsenic trichloride. After the addition of the tetraethyl lead, continue to heat the reaction mixture at 100 Celsius for 1 hour with rapid stirring. Afterwards, remove the heat source, and then allow the reaction mixture to cool to room temperature. Thereafter, replace the reflux condenser with a regular condenser (with receiver flask), and then vacuum distill the reaction mixture at 75 millimeters of mercury to obtain a water white ethyldichloroarsine product with a purity of 95%. Note: use the oil bath as the heat source, and heat the oil to about 120 Celsius for the distillation process. After the distillation (which might take up to 5 hours or more), the ethyldichloroarsine will be obtained as a water white liquid with a purity of about 95%. If desired, place this water white ethyldichloroarsine into a fractional distillation apparatus, and fractionally distill at 83 Celsius and under a vacuum of 75 millimeters of mercury to obtain a purified ethyldichloroarsine product of about 98% purity. Note: The 95% pure ethyldichloroarsine need not be purified for use in chemical warfare operations.



**Figure 042.** Left illustration: reaction apparatus during addition of the tetraethyl lead (the gas inlet tube has been replaced by the addition funnel as this point). Right illustration: Vacuum setup for distillation to recover ethyldichloroarsine of 95% purity.

### Procedure 3-004B: Preparation of Ethyldichloroarsine

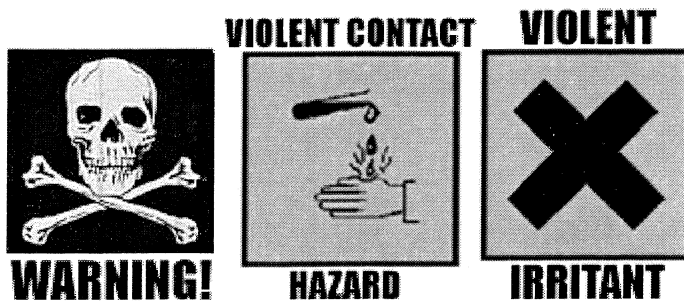
**Summary:** Ethyldichloroarsine is prepared in a two-stop process starting with the formation of ethylmagnesium chloride. Ethylmagnesium chloride is prepared by the reaction between ethyl chloride and magnesium turnings in tetrahydrofuran. The resulting tetrahydrofuran solution containing the ethylmagnesium chloride is then treated with a solution of arsenic trichloride in hexanes. The resulting reaction mixture is then evaporated to remove the solvents, and the ethyldichloroarsine is then recovered by fractional distillation.



*Reaction Equation (by products omitted)*

<b>Materials:</b>	1. 41 grams of ethyl chloride (lecture bottle or liquid)	4. 114 grams of anhydrous arsenic trichloride
	2. 15.4 grams magnesium turnings	5. 500 milliliters of hexanes
	3. 200 milliliters of tetrahydrofuran	

#### Hazards:



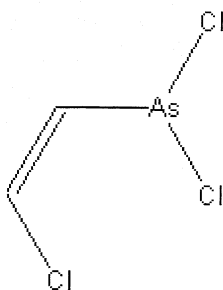
Do not attempt in anyway to prepare ethyldichloroarsine using the following procedure unless proper safety precautions are taken. 1) Perform all operations in a clean box, in which is completely sealed from the air. Note: A clean box in this case is not needed. Ethyldichloroarsine can be safely prepared as long as the maker wears proper gas mask, and nitrile gloves. 2) After each procedure, all glassware and non-electric equipment should be soaked in bleach before removing from the clean box, and/or before rinsing and storing. Any electrical equipment that may be contaminated (even if suspected), such as hot plates and stirring equipment should be carefully wiped down with a rag soaked in bleach followed by wiping down with hot water. 3) The desired ethyldichloroarsine product should be stored in amber bottles, preferably non-breakable containers, and stored in a cool dry place away from sunlight. The bottles should also be placed inside an airtight sealed plastic bag, such as a 'ziplock' bag. 4) Storage of any and all blister agents should be in airtight cabinets, drawers, or the like, and said storage spaces should be equipped with chemical agent detection monitors to alert of any potential leakage.

Use caution when handling arsenic trichloride, which is very toxic, and can be absorbed through the skin. Extinguish all flames before using ethyl chloride and tetrahydrofuran, both of which are highly flammable. Make sure to perform the peroxide test before using tetrahydrofuran (which has been in storage for sometime). Use caution when handling ethylmagnesium chloride, which may ignite spontaneously if exposed to air over a wide surface area (i.e., a rag soaked in a solution of ethylmagnesium chloride and tetrahydrofuran will begin to smoke, and then catch fire when exposed to air).

**Procedure:** Into a suitable flask, place 200 milliliters of anhydrous tetrahydrofuran, and then add 41 grams of ethyl chloride. Note: you can either bubble the ethyl chloride gas into the tetrahydrofuran, or add in 41 grams of liquid ethyl chloride. Thereafter, slowly add 15.4 grams of magnesium turnings to the tetrahydrofuran/ethyl chloride mixture while stirring the tetrahydrofuran/ethyl chloride

mixture and maintaining its temperature below 60 Celsius. Note: During the magnesium addition, the temperature will rise to about 60 Celsius. Don't let the temperature rise above 60 Celsius. After the addition of the magnesium, briefly stir the reaction mixture for about 5 minutes, and then place the reaction mixture into an ice bath and chill to 0 Celsius. Immediately when the temperature of the reaction mixture reaches 0 Celsius, carefully add drop wise, a solution prepared by adding 114 grams of arsenic trichloride into 500 milliliters of hexanes. During the arsenic trichloride/hexanes addition, vigorously stir the reaction mixture while keeping its temperature at 0 Celsius at all times. After the addition of the arsenic trichloride/hexanes mixture, vigorously stir the reaction mixture at 0 Celsius for 2 hours. After 2 hours, carefully add in 100 milliliters of cold water (to dissolve the magnesium chloride), and then briefly stir the reaction mixture for about 10 minutes. Immediately thereafter, place the entire mixture into a separatory funnel, and remove the lower organic layer. Then quickly filter this lower organic layer to remove any insoluble impurities, and then place this organic layer into a rotary evaporator, or vacuum distillation apparatus, and remove the tetrahydrofuran and hexanes solvents under vacuum. When both solvents have been removed, place the remaining liquid into a clean vacuum distillation apparatus, and fractionally distill the ethyldichloroarsine at 83 Celsius and under a vacuum of 75 millimeters of mercury to obtain a purified ethyldichloroarsine product of about 98% purity. Note: Diethyldichloroarsine and triethylarsine will be obtained in small quantities as by-products.

### 03-005. Lewisite. 2-Chlorovinylchloroarsine. (*2-Chloroethenyl*)arsenous dichloride; *Chlorovinylarsine dichloride*



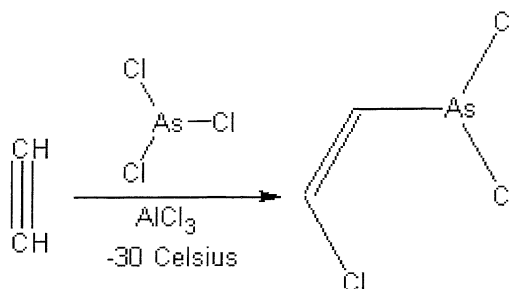
Lewisite

Lewisite is a potent arsenical vesicant. Lewisite forms a colorless to dark brownish to blackish or amber colored liquid. Military grade lewisite will most likely be a dark colored liquid. Lewisite gives off a colorless vapor, with a slight odor of germaniums. Lewisite has a melting point of 0 Celsius, and a boiling point of 190 Celsius (with decomposition). It can be easily distilled at 77 Celsius, and under a vacuum of 12 millimeters of mercury. It tends to solidify at -13 Celsius. Lewisite is soluble in most common organic solvents, but it is insoluble in water, and dilute mineral acids. It can be easily decontaminated by bleaching powder, or ordinary bleach, and it is also destroyed by alkalis such as sodium hydroxide solutions. Lewisite can persist in the environment for up to 1 month under warm and dry conditions, but its persistence in warm and moist conditions may only be up to 7 days. Reports have shown that lewisite may persist for longer periods of time. Most modern militaries don't regard lewisite as a potential threat in chemical warfare, but nevertheless, the power and violence of lewisite should not be underestimated nor brushed aside. It is potent blister agent, but along with its vesicant properties, it shows significant respiratory and systematic poisoning effects. Small amounts of vapor in the eyes can render blindness to any exposed personnel. Small concentrations of vapor or liquid inhaled or ingested can lead to respiratory distress, coughing, choking, bleeding, or cardiac arrest. Ingestion can lead to violent gastrointestinal disorders. The primary use of lewisite is to injure personnel, rather than kill them. The major uses of lewisite in warfare are to blind enemy troops, and also to incapacitate them via its vesicant properties, and respiratory effects. Lewisite is an effective war gas, and it can be used in all sorts of military operations. It tends to linger in low lining areas during nighttime, and its vapor may rise to higher lining areas during the day. Holes, ditches, trenches, and bunkers contaminated with lewisite can help disseminate the agent to areas above ground, as its vapor volatilizes with changing weather conditions. In cold conditions, such as nighttime, the agent will linger in low lining areas, but after sun rise, the agent shows appreciable volatility leading to vapor rising to above ground areas; upon night fall, the agent will once again linger in the low lining areas. Lewisite can be mixed with nerve agents, or with the nitrogen mustards for increased effect. Note: Lewisite is capable of penetrating rubber, rendering some gas masks ineffective. It can be disseminated using aerosols, explosives munitions, atomizers or humidifiers, or foggers. **Lewisite is a potent and fast acting blister agent capable of causing irritation and itching within minutes of skin exposure. Skin exposure to mild concentrations of vapor or liquid will cause sunburn like effects, with pain subsiding after 48 hours. Skin exposure to larger concentrations of vapor or liquid leads to immediate stinging and pain, with blisters developing within 30 to 80 minutes. As little as 500 micromilliliters of agent on the skin can lead to blisters, or severe skin irritation. The liquid inside the blisters is non-toxic. Skin absorption of as little as 2 milliliters can lead to internal organ damage, and systematic poisoning leading to death. Eye exposure to liquid or vapor causes blindness, and eye exposure to as little as 1000 to 5500 micrograms is sufficient to cause blindness in 50% of cases. Concentrations of 10 to 15 milligrams will cause blindness to any exposed personnel. The lethal dose through inhalation in the average man is 35 to 40 milligrams per kilogram of body weight (a total of 2 milliliters or 3.2 grams).**

OVERALL RATING (scale from 1 to 10)	
<i>Effectiveness (as blister agent):</i> 8	<i>Field Stability:</i> 9
<i>Persistence (open area):</i> 9	<i>Storage stability:</i> 8
<i>Persistence (enclosed area):</i> 9	<i>Toxicity (as blister agent):</i> 8
TOTAL EFFECTIVENESS (as blister agent): 8.5	
OVERALL TOXICITY (as warfare agent): 3 <sup>3</sup> / <sub>4</sub>	

### Procedure 3-005A: Preparation of Lewisite

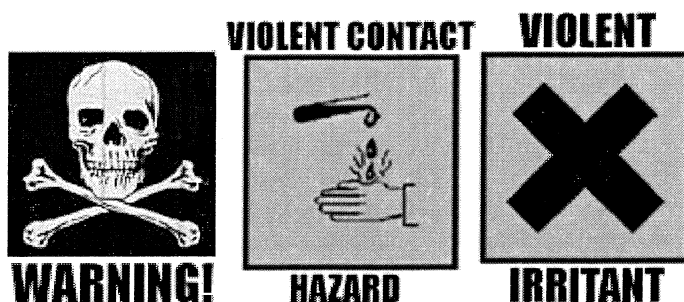
**Summary:** Lewisite is readily prepared by the addition of acetylene gas to a mixture of arsenic trichloride and aluminum chloride. Because aluminum chloride is a very powerful catalyst, the temperature of the reaction mixture must be strictly maintained. Too much heat can lead to explosions, or the formation of unwanted products such as tar, and polymerization products. After the reaction, the mixture is then filtered, and then fractionally distilled under vacuum to separate the lewisite.



*Reaction Equation (by products omitted)*

<b>Materials:</b>	1. 5 grams of dry acetylene (lecture bottle)	3. 30 grams of anhydrous aluminum chloride
	2. 34 grams of anhydrous arsenic trichloride	

#### Hazards:



Do not attempt in anyway to prepare lewisite using the following procedure unless proper safety precautions are taken. 1) Perform all operations in a clean box, in which is completely sealed from the air. Note: A clean box in this case is not needed. Lewisite can be safely prepared as long as the maker wears proper gas mask, and nitrile gloves. 2) After each procedure, all glassware and non-electric equipment should be soaked in bleach before removing from the clean box, and/or before rinsing and storing. Any electrical equipment that may be contaminated (even if suspected), such as hot plates and stirring equipment should be carefully wiped down with a rag soaked in bleach followed by wiping down with hot water. 3) The desired lewisite product should be stored in amber bottles, preferably non-breakable containers, and stored in a cool dry place away from sunlight. The bottles should also be placed inside an airtight sealed plastic bag, such as a 'ziplock' bag. 4) Storage of any and all blister agents should be in airtight cabinets, drawers, or the like, and said storage spaces should be equipped with chemical agent detection monitors to alert of any potential leakage.

Use caution when handling arsenic trichloride, which is very toxic, and can be absorbed through the skin. Use caution when handling anhydrous aluminum chloride, which is corrosive and reacts violently with water yielding corrosive and toxic gases. Extinguish all flames before using acetylene. Acetylene is highly flammable, and explosive.

**Procedure:** Into a suitable flask, place 34 grams of arsenic trichloride, followed by 30 grams of anhydrous aluminum chloride. Thereafter, place the flask into a dry ice acetone bath, and chill to  $-30$  Celsius. Thereafter, bubble into the mixture, 5 grams of acetylene gas over a period of 60 minutes while carefully controlling the reaction mixtures temperature. Note: The temperature must



## Chapter 8: Preparation of Blister Agents

be strictly controlled to avoid possible explosions, and formation of undesired side products. During the addition of the acetylene gas, vigorously stir the reaction mixture. After the addition of the acetylene gas, vigorously stir the reaction at  $-30$  Celsius for 1 hour. Thereafter, remove the dry ice/acetone bath, and then allow the reaction mixture to warm to room temperature. Then quickly filter the reaction mixture to remove any insoluble impurities, and then place the reaction mixture into the vacuum distillation apparatus illustrated in figure 043, and then fractionally distill the mixture at  $77$  Celsius under a vacuum of 12 millimeters of mercury. Note: dichlorovinylchloroarsine (secondary lewisite), and trichlorovinylarsine (tertiary lewisite) will be obtained as by-products. These by-products can be used as warfare agents as well. Note: Instead of fractionally distilling the reaction mixture, the filtered reaction mixture can be used directly in chemical warfare operations.

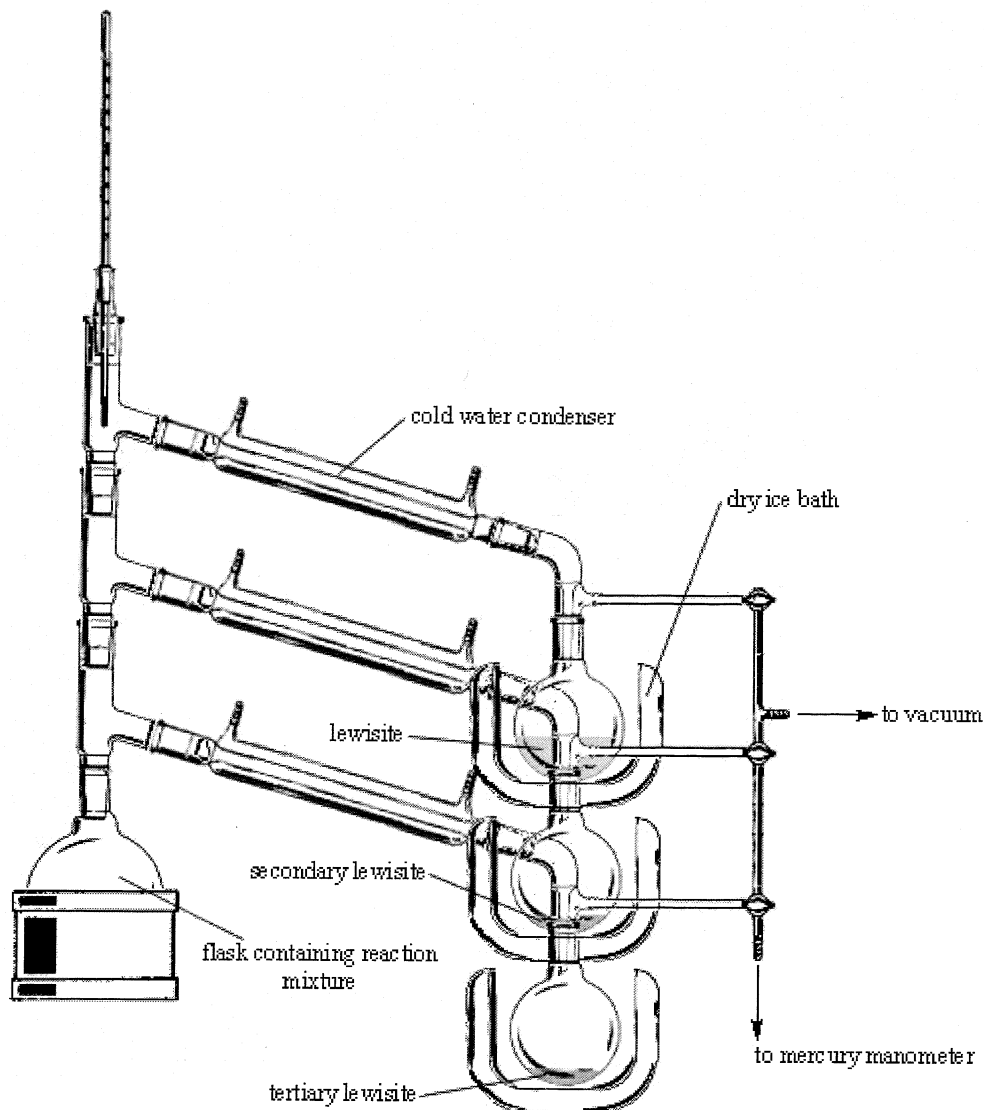
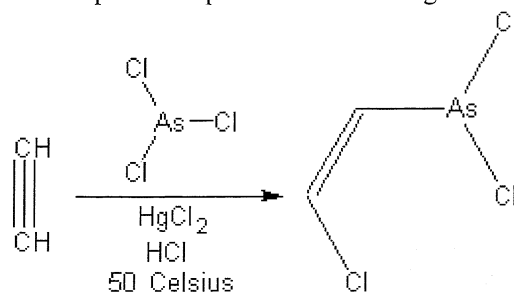


Figure 043. Vacuum distillation apparatus for separating lewisite from the reaction mixture.

### Procedure 3-005B: Preparation of Lewisite (modified process)

**Summary:** Lewisite is readily prepared in a modified process by the addition of acetylene gas to a mixture of arsenic trichloride and hydrochloric acid containing a certain amount of mercuric chloride catalyst. During the reaction, the acetylene gas is bubbled into the mixture at  $50$  Celsius. After the acetylene gas addition, the reaction mixture is stirred and refluxed for 30 minutes. The resulting lewisite layer is then removed via a separatory funnel, and the lewisite layer then filtered. The filtered lewisite layer is then fractionally distilled to obtain a purified lewisite product.

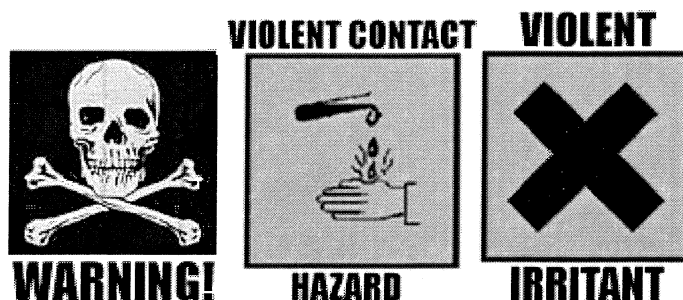
## Chapter 8: Preparation of Blister Agents



*Reaction Equation (by products omitted)*

<b>Materials:</b>	1. 5 grams of dry acetylene (lecture bottle)	3. 32 grams of mercuric chloride
	2. 34 grams of anhydrous arsenic trichloride	4. 50 milliliters of 35 to 38% hydrochloric acid

### Hazards:



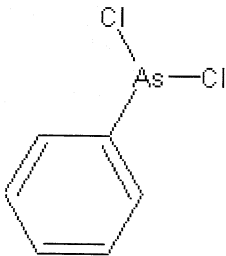
Do not attempt in anyway to prepare lewisite using the following procedure unless proper safety precautions are taken. 1) Perform all operations in a clean box, in which is completely sealed from the air. Note: A clean box in this case is not needed. Lewisite can be safely prepared as long as the maker wears proper gas mask, and nitrile gloves. 2) After each procedure, all glassware and non-electric equipment should be soaked in bleach before removing from the clean box, and/or before rinsing and storing. Any electrical equipment that may be contaminated (even if suspected), such as hot plates and stirring equipment should be carefully wiped down with a rag soaked in bleach followed by wiping down with a rag soaked in hot water. 3) The desired lewisite product should be stored in amber bottles, preferably non-breakable containers, and stored in a cool dry place away from sunlight. The bottles should also be placed inside an airtight sealed plastic bag, such as a 'ziplock' bag. 4) Storage of any and all blister agents should be in airtight cabinets, drawers, or the like, and said storage spaces should be equipped with chemical agent detection monitors to alert of any potential leakage.

Use caution when handling arsenic trichloride, which is very toxic, and can be absorbed through the skin. Use caution when handling mercuric chloride, which is highly toxic, and may be fetal if swallowed. Wear gloves when handling highly corrosive hydrochloric acid. Extinguish all flames before handling acetylene gas, which is highly flammable and explosive.

**Procedure:** Into a suitable flask, place 34 grams of arsenic trichloride, followed by an acid solution made by adding and dissolving 32 grams of mercuric chloride, and 50 milliliters of cold water into 50 milliliters of 35 to 38% hydrochloric acid. Note: If the mercuric chloride fails to dissolve, add additional 35 to 38% hydrochloric acid until the mercuric chloride dissolves. Thereafter, gently heat the mixture to 50 Celsius (using a reflux apparatus) with vigorous stirring. When the temperature of the mixture reaches 50 celsius, rapidly add 5 grams of acetylene gas over a period of about 15 to 30 minutes while vigorously stirring the reaction mixture, and keeping its temperature around 50 celsius (under reflux conditions). After the addition of the acetylene gas, continue to heat the reaction mixture at 50 Celsius with vigorous stirring for 30 minutes. Thereafter, remove the heat source, and allow the reaction mixture to cool to room temperature. Then remove the lower lewisite layer using a seperatory funnel, or by decantation, and then quickly filter the lewisite layer to remove any insoluble impurities. Then place the filtered lewisite layer into a vacuum distillation apparatus similar to the one illustrated in figure 043 (see prep 3-005A), and then fractionally distill the mixture at 77 Celsius under a vacuum of 12 millimeters of mercury. Note: dichlorovinyldichloroarsine (secondary lewisite), and trichlorovinylarsine (tertiary lewisite) will be obtained as by-products. These by-products can be used as warfare agents as well. Note: Instead of fractionally distilling the reaction mixture, the filtered reaction mixture can be used directly in chemical warfare operations.

### 03-006. PD. Phenyldichloroarsine

Chapter 8: Preparation of Blister Agents



Phenyldichloroarsine

Phenyldichloroarsine forms a colorless liquid, which may be slightly colored brown if impure. The impure compound may also have a tar like appearance to it. The pure liquid (military grade) is a colorless odorless oily liquid. The liquid has a melting point of -20 Celsius, making it well suitable for cold weather climates. It has a boiling point of 252 Celsius (the impure liquid may begin to decompose when heated to 180 Celsius. Phenyldichloroarsine should never be distilled at its boiling point, and it should be distilled under high vacuum and under a temperature of 150 Celsius. The pure liquid can be heated to its boiling point without any decomposition resulting. Phenyldichloroarsine is a powerful vomiting agent capable of also forming blisters. Its blister power is similar to lewisite and ethyldichloroarsine, but with less severity. When as little as 5 to 50 milligrams is inhaled, it produces severe nausea and vomiting resulting in acute incapacitation (higher concentrations may be needed in order to produce vomiting effects). Skin exposure to the agent can produce irritation, with delayed blister formation up to 32 hours. Due to its nauseating effect upon inhalation, the agent is easily detected in field concentrations. Blister formation is rare due its ease of recognition in the field, and fast rate of decontamination. Skin toxicity of this agent is less severe then other blisters agents. Blister formation is accelerated by larger doses; skin contact to 500 to 1500 milligrams may lead to blisters within 4 to 8 hours. Skin contact is seldom fatal. Inhalation, ingestion, or skin absorption can lead to systematic poisoning resulting within 12 to 32 hours after exposure. Phenyldichloroarsine immediately attacks the eyes, producing sever irritation, and delayed poisoning effects resulting in potential blindness; although, rather high doses are needed to produce blindness. Phenyldichloroarsine can be used as an effective vomiting agent, as well as blister agent. The agent is best used in closed environments from where it may be disseminated by tactical weapons such as grenades, or booby trap bombs. Note: Some security systems for banks, and high security facilities use phenyldichloroarsine grenades, which releases the said agent upon security breeches. The persistence of phenyldichloroarsine may be from 48 hours to 7 days under normal environmental conditions. It is easily decomposed by bleach. Note: Phenyldichloroarsine is capable of penetrating rubber, rendering some gas masks ineffective. It can be disseminated with aerosols, explosives munitions, atomizers or humidifiers, or foggers.

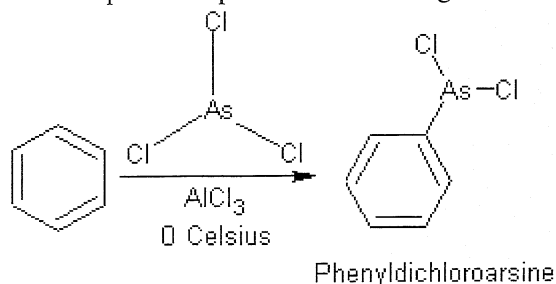
**Phenyldichloroarsine is a moderate fast acting blister agent capable of causing casualties within minutes of dissemination. Although its vesicant properties are rather mild, and delayed, it may be used to incapacitate personnel in field operations. The lethal dose through inhalation in the average man ranges from 900 to 2700 milligrams per person. As little as 5 to 15 milligrams through inhalation may produce nausea and/or vomiting. Skin exposure to as little as 1 milliliter may produce blisters within 4 to 32 hours of exposure. The agent causes almost immediate irritation upon skin contact, but less irritation then that of ethyldichloroarsine or lewisite.**

OVERALL RATING (scale from 1 to 10)	
<i>Effectiveness (as blister agent): 6</i>	<i>Field Stability: 8</i>
<i>Persistence (open area): 7</i>	<i>Storage stability: 9</i>
<i>Persistence (enclosed area): 8</i>	<i>Toxicity (as blister agent): 6</i>
<b>TOTAL EFFECTIVENESS (as blister agent): 7.3</b>	
<b>OVERALL TOXICITY (as warfare agent): 3</b>	

**Procedure 3-006A: Preparation of Phenyldichloroarsine**

**Summary:** Phenyldichloroarsine is readily prepared by reacting benzene with arsenic trichloride in the presence of anhydrous aluminum chloride. The anhydrous aluminum chloride catalyzes the reaction. After the reaction is over, the reaction mixture is washed with ice-cold water (to destroy the aluminum chloride, and dissolve hydrochloric acid), and the resulting two-phase mixture is then separated using a separatory funnel. The lower phenyldichloroarsine layer is then vacuum distilled to obtain the desired agent.

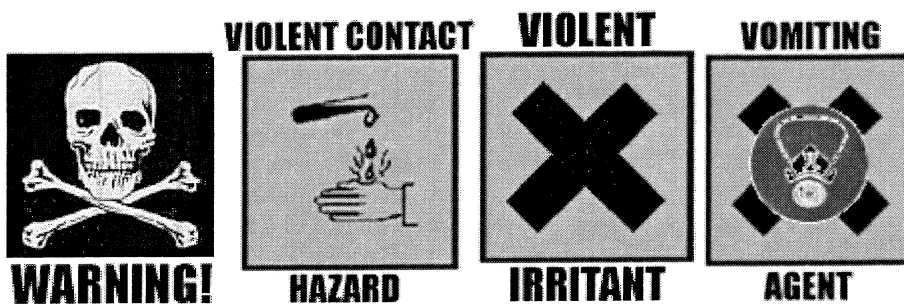
## Chapter 8: Preparation of Blister Agents



*Reaction Equation (by products omitted)*

<b>Materials:</b>	1. 27 grams of dry benzene	3. 5 grams of anhydrous aluminum chloride
	2. 62 grams of anhydrous arsenic trichloride	

### Hazards:

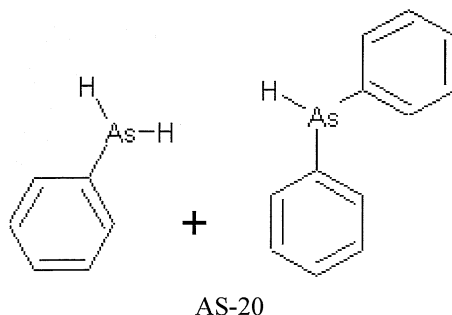


Do not attempt in anyway to prepare phenyldichloroarsine using the following procedure unless proper safety precautions are taken. 1) Perform all operations in a clean box, in which is completely sealed from the air. Note: A clean box in this case is not needed. Phenyldichloroarsine can be safely prepared as long as the maker wears proper gas mask, and nitrile gloves. 2) After each procedure, all glassware and non-electric equipment should be soaked in bleach before removing from the clean box, and/or before rinsing and storing. Any electrical equipment that may be contaminated (even if suspected), such as hot plates and stirring equipment should be carefully wiped down with a rag soaked in bleach followed by wiping down with a rag soaked in hot water. 3) The desired phenyldichloroarsine product should be stored in amber bottles, preferably non-breakable containers, and stored in a cool dry place away from sunlight. The bottles should also be placed inside an airtight sealed plastic bag, such as a 'ziplock' bag. 4) Storage of any and all blister agents should be in airtight cabinets, drawers, or the like, and said storage spaces should be equipped with chemical agent detection monitors to alert of any potential leakage. Use caution when handling arsenic trichloride, which is very toxic, and can be absorbed through the skin. Use care when handling anhydrous aluminum chloride, which reacts violently with water liberating much heat and toxic and corrosive gases. Benzene is a known carcinogen, wear gloves when handling, and avoid inhalation of vapors.

**Procedure:** Into a suitable flask equipped with mechanical stirrer, thermometer, and addition funnel, place 27 grams of benzene followed by 5 grams of anhydrous aluminum chloride. Then place the flask containing the benzene into a salt/ice bath and chill to -10 Celsius. Then place 62 grams of anhydrous arsenic trichloride into the addition funnel. Thereafter, slowly add drop wise, the arsenic trichloride to the benzene mixture over a period of several hours while keeping the temperature of the reaction mixture below 0 Celsius. Note: During the addition, heat will be evolved. During the addition of the arsenic trichloride, vigorously stir the reaction mixture. After the addition of the arsenic trichloride, vigorously stir the reaction mixture for 1 hour at a temperature below 0 Celsius, and then remove the salt ice bath. Thereafter, before the reaction mixture warms to room temperature, quickly wash the reaction mixture with 50 milliliters of pre chilled ice-cold water, and stir the mixture for several minutes. Afterwards, place the entire mixture into a separatory funnel, and remove the lower phenyldichloroarsine layer, and then filter this lower layer to remove any insoluble impurities. Then place the filtered reaction mixture into a vacuum distillation apparatus and fractionally distil under high vacuum and under a temperature of 150 Celsius to obtain phenyldichloroarsine. Note: a small amount of diphenylchloroarsine may be obtained as well.

### 03-007. AS-20. Distilled Arsin mixture. *Phenylarsine/Diphenylarsine mixture*

## Chapter 8: Preparation of Blister Agents



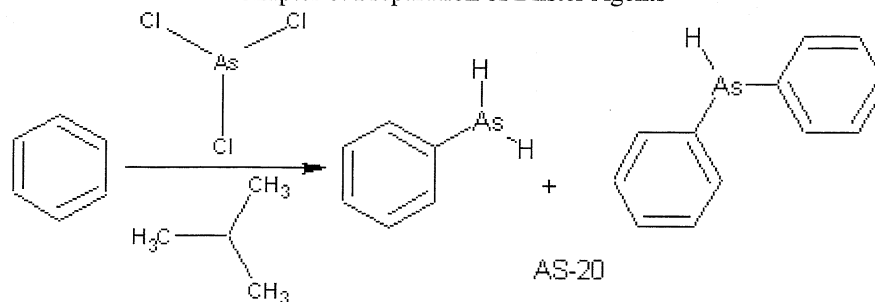
AS-20 is a colorless liquid composed of phenylarsine, and diphenylarsine. The liquid has a strong, characteristic biting odor. The vapor may go unnoticed even in high concentrations. The liquid is very stable, and it's only very slightly volatile under normal conditions. AS-20 can persist in the environment for up to several weeks during cool and dry conditions. Warm and moist conditions may give rise to slow hydrolysis of the liquid, but its rate of hydrolysis is rather slow. Reports have demonstrated that AS-20 may persist in the environment for up to 1 month. Areas contaminated with As-20 can cause casualties to any exposed personnel. As with other blister agents, AS-20 produces delayed effects, leading to serious blisters and tissue damage within 32 hours of skin contact. The effectiveness of AS-20 is less than HN1, HN2, or HN3, but nonetheless, it's a potent vesicant capable of producing casualties. Along with its vesicant properties, it shows remarkable tendency towards producing irritation. Inhalation, skin contact, or eye contact of the vapor or liquid can lead to immediate pain and irritation; although, these effects may be delayed. AS-20 is also a highly effective blood agent, capable of producing death to those who inhale high concentrations of the vapor. Phenylarsine, and diphenylarsine can both be used separately for military operations if desired. Both phenylarsine and diphenylarsine are effective blood agents, and vesicants. The persistence of both is increased when they are mixed, hence the formulation AS-20. AS-20 can be used in the same regards as the other blister agents. It should not be mixed with the sulfur mustards, or nitrogen mustards, as chemical reactions might take place. Areas contaminated with AS-20 can still render enough agent to produce casualties through skin absorption after 6 weeks. AS-20 can persist in enclosed areas such as bunkers, tunnels, and rooms for up to 2 months. AS-20 is capable of absorbing through certain types of rubber. Some military gas masks may not be totally effective at removing said agent. AS-20 is easily destroyed by bleach. It can be disseminated through aerosols, explosives munitions, atomizers or humidifiers, or foggers. **AS-20 is a delayed action blister agent, but a moderately fast acting blood agent. Skin, and eye contact to the vapor or liquid can lead to immediate pain and irritation. Skin and eye exposure to as little as 10 milligrams can result in pain and irritation. Skin exposure to as little as 50 milligrams can lead to blisters if not immediately treated. The lethal dose through inhalation in the average man ranges from 200 to 600 milligrams, but may be as high as 1200 milligrams. In a few rare cases, inhalation of 3000 to 4500 parts per million over a period of 30 minutes can result in death. Skin absorption of as little as 50 milligrams can lead to systematic poisoning.**

OVERALL RATING (scale from 1 to 10)	
<i>Effectiveness (as blister agent):</i> 7	<i>Field Stability:</i> 8
<i>Persistence (open area):</i> 8	<i>Storage stability:</i> 8
<i>Persistence (enclosed area):</i> 9	<i>Toxicity (as blister agent):</i> 8½
<b>TOTAL EFFECTIVENESS (as blister agent):</b> 8	
<b>OVERALL TOXICITY (as warfare agent):</b> 3¾	

### Procedure 3-007A: Preparation of AS-20

**Summary:** AS-20 can be prepared by reacting a mixture of arsenic trichloride in benzene, with a mixture of isopentane and anhydrous aluminum chloride in benzene. After the reaction, the resulting two-layer mixture is separated by a separatory funnel, and the desired organic layer washed, dried, and then vacuum distilled twice at two different temperatures and vacuum pressures to obtain two fractions. The first fraction is phenylarsine, and the second fraction is diphenylarsine. Both fractions can be used separately if desired, but they are more effective when combined. Note: The preparation of AS-20 discussed in this procedure is similar or related to the process discussed in serial number 517,369, June 22<sup>nd</sup>, 1955, by Louis Schmerling, of Riverside, ILL; assigned to Universal Oil Products Company. This process may be protected by industrial/commercial process applications. Consult said application number before using the mentioned process for commercial or industrial purposes.

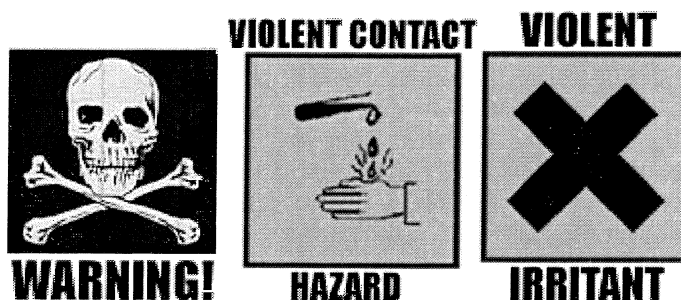
Chapter 8: Preparation of Blister Agents



Reaction Equation (by products omitted)

<b>Materials:</b>	1. 200 grams of benzene	4. 2.5 grams of anhydrous aluminum chloride
	2. 45 grams of arsenic trichloride	5. 100 milliliters of 5% baking soda solution
	3. 50 grams of isopentane	6. 5 grams of anhydrous sodium sulfate

**Hazards:**



Do not attempt in anyway to prepare AS-20 using the following procedure unless proper safety precautions are taken. 1) Perform all operations in a clean box, in which is completely sealed from the air. Note: A clean box in this case is not needed. AS-20 can be safely prepared as long as the maker wears proper gas mask, and nitrile gloves. 2) After each procedure, all glassware and non-electric equipment should be soaked in bleach before removing from the clean box, and/or before rinsing and storing. Any electrical equipment that may be contaminated (even if suspected), such as hot plates and stirring equipment should be carefully wiped down with a rag soaked in bleach, followed by wiping down with hot water. 3) The desired AS-20 product should be stored in amber bottles, preferably non-breakable containers, and stored in a refrigerator away from sunlight. The bottles should also be placed inside an airtight sealed plastic bag, such as a 'ziplock' bag. 4) Storage of any and all blister agents should be in airtight cabinets, drawers, or the like, and said storage spaces should be equipped with chemical agent detection monitors to alert of any potential leakage.

Use care when handling arsenic trichloride, which is very poisonous and can be absorbed through the skin. Use caution when handling benzene, which is a known carcinogen. Anhydrous aluminum chloride reacts violently with water producing toxic and corrosive gases. Isopentane is highly flammable, extinguish all flames before handling.

**Procedure:** Into a suitable flask, place 100 grams of dry benzene, followed by 45 grams of arsenic trichloride. Into a separate clean flask (equipped with an addition funnel, electric stirrer, and gas inlet tube; see figure 044), add 100 grams of benzene, 50 grams of isopentane, and then 2.5 grams of anhydrous aluminum chloride. Thereafter, gently heat this benzene/isopentane/aluminum chloride mixture to 35 Celsius. When the temperature reaches 35 Celsius, place the benzene/arsenic trichloride mixture into the addition funnel, and then slowly add this benzene/arsenic trichloride mixture to the benzene/isopentane/aluminum chloride mixture over a period of about 60 minutes, while vigorously stirring the benzene/isopentane/aluminum chloride mixture, and maintaining its temperature at 35 Celsius. Note: Start the nitrogen purge before adding the benzene/arsenic trichloride mixture; the nitrogen purge is to ensure an oxygen free atmosphere within the apparatus. After the addition of the benzene/arsenic trichloride mixture, continue to stir the reaction mixture at 35 Celsius for about 30 minutes. Thereafter, remove the heat source and allow the reaction mixture to cool to room temperature. Then place the entire reaction mixture into a separator funnel, and then collect the upper organic layer. Once the upper layer has been recovered, briefly wash it by adding 50 milliliters of cold water, followed by 100 milliliters of a 5% baking soda solution, and then stir the mixture for several minutes. Then place the mixture into a separatory funnel, and recover the upper organic layer once again. Then dry this upper organic layer by adding 5 grams of anhydrous sodium sulfate, and then stir the mixture for several minutes. Then filter-off the sodium sulfate, and then place the filtered mixture into a vacuum distillation apparatus, and vacuum distill at 95 Celsius under a vacuum of 70 milliliters of mercury to obtain a fraction composed of phenylarsine. When no more phenylarsine is distilled over, raise the temperature to the remaining mixture to 175 Celsius, and vacuum distill at 25 millimeters of

mercury to obtain the second fraction composed of diphenylarsine. Note: These two fractions can then be combined to form the desired AS-20, or used separately. Note: For better effects in field operations, these two fractions should be combined.

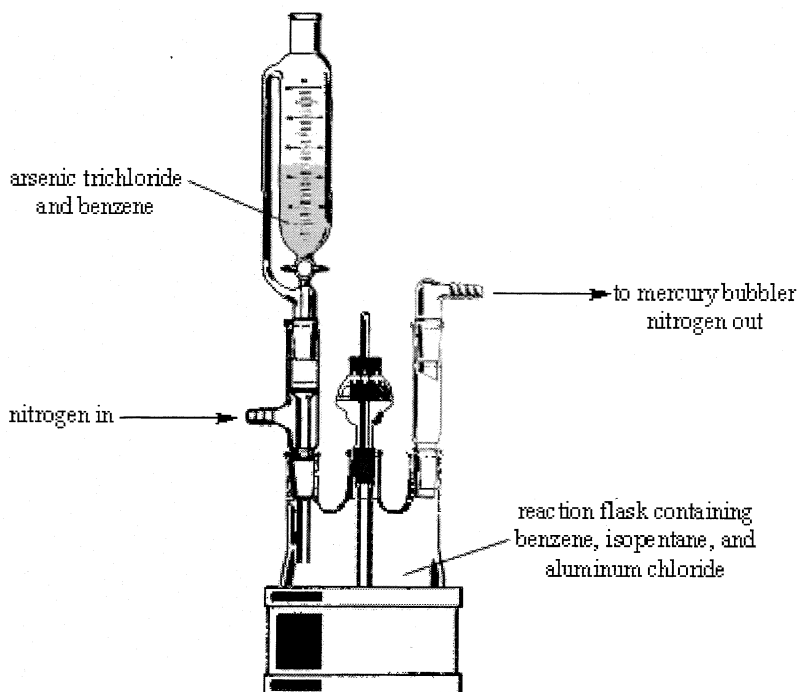
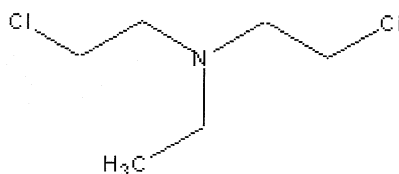


Figure 044. Apparatus for the preparation of AS-20.

**03-008. HN1. N-ethyl-2,2'-di(chloroethyl) amine; N,N-bis(2-chloroethyl)ethanamine; 2,2',-dichlorodiethylethylamine**



HN1

HN1 forms a mobile, brownish to slightly clear, viscous liquid, which has similar properties to HN2 and HN3. The pure liquid is a slightly odorless liquid, but it may have an odor of fish. Military grade HN1 is a brownish to lightly clear liquid with a slight odor of fish or no odor at all. The impure liquid is a definite brownish color, with a varying odor. It is slightly volatile under normal conditions, and is more volatile than HN2. It is quite persistent in the environment, being more persistent than HN2; its persistence in the environment may be up to 5 to 9 days under normal conditions. Under affluent conditions, such as dry and warm climates, HN1 may persist for up to 6 weeks. HN1 forms a colorless vapor upon evaporation, and will not be detectable in low or even high concentrations by the average soldier. HN1 is insoluble in water, and is only slowly hydrolyzed by it. It is very soluble in oils and many organic solvents, and it is miscible with chloroform, carbon tetrachloride, dimethylformamide, and carbon disulfide. HN1 has a melting point ranging from  $-20$  Celsius to  $-10$  Celsius, depending on purity, and it has a boiling point of  $193$  Celsius. It can be distilled at lower temperatures under a vacuum of 50 to 10 millimeters of mercury. The stability of HN1 in cold environments is greater than HN3. Like HN2 and HN3, pure HN1 may polymerize on standing, and stabilization may or may not be needed. For prolonged storage, it should be mixed with chloroform, or methylene chloride. Straight HN1 can be used in military operations with excellent results, either by itself, or when mixed with inert agents such as hydrocarbon waxes, or hydrocarbon oils, and then disseminated properly. Dissemination of pure HN1 may only last for up to 2 to 3 weeks in the environment under normal conditions due to volatility and decomposition. HN1 is a deadly vesicant capable of causing blisters anywhere on the body within 4 to 12 hours of exposure. Ordinary clothing has no protective effect to HN1, as it is easily absorbed through ordinary cloths, and then into the skin. Areas that have been contaminated for up to  $2\frac{1}{2}$  weeks can still render appreciable quantities of HN1 suitable for clothing and then skin absorption. HN1 is much more difficult to decontaminate than the sulfur mustard agents, or nerve agents, and HN1 is up to 3 to 4 times more difficult to decontaminate than sulfur mustards. Like HN2 and HN3, HN1 gives absolutely no warning of its presence on

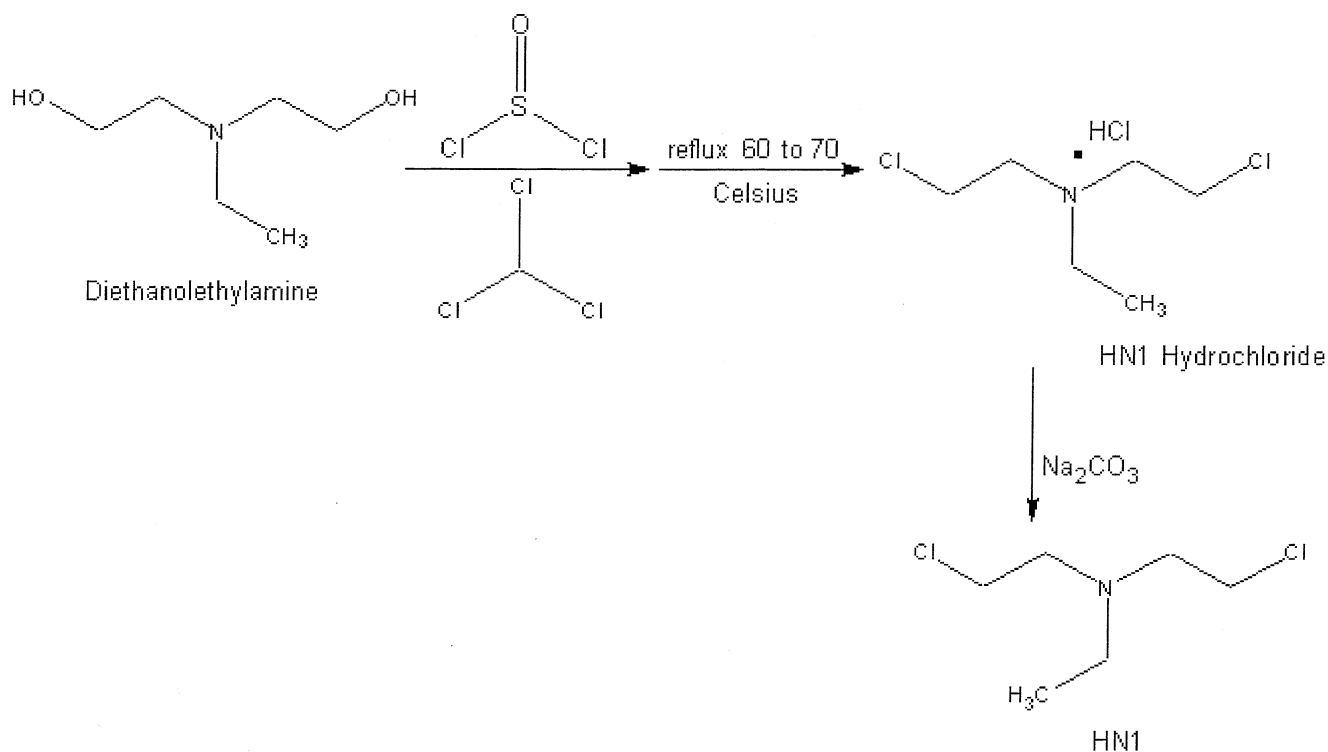
### Chapter 8: Preparation of Blister Agents

the skin, victims exposed to HN1 will not be aware of such an act until 4 to 12 hours later; where upon "burn like" blisters and bruises begin to show up on the skin. Preventing spreading of the contaminated flesh areas can be difficult, and the effected areas should be treated with excessive amounts of a warm solution of concentrated sodium hydroxide, followed by washing with large amounts of soapy hot water (hard water, not soft water). After the washing period, the wounds should be treated with an ointment of a alkali gel made from sodium carbonate and wax, followed by applying clean bandages to said wounds. Untreated, and even treated wounds can leave permanent scarring of the flesh. Wounds caused by HN1 are often slow to heal. Note: HN1 produces blisters after exposure to said agent, and these blisters should be immediately scrubbed and broken to remove poisonous fluid. The fluid inside blisters caused by HN1 is poisonous. HN1 is an effective blister agent, and is superior in nature to mustard gas. It can be effectively disseminated through aerosols, explosives munitions, atomizers or humidifiers, or foggers. **HN1 is a delayed action casualty producing agent.** Personnel exposed to liquid or vapor will develop burn like blisters and bruises within 4 to 24 hours of exposure. Immediate exposure to agent produces no visual signs, even if exposure is by inhalation. Personnel who inhale or ingest liquid or vapor may suffer violent consequences within hours of exposure. Inhalation of the agent may be fatal within 60 minutes of exposure. Lethal dose for 50% of population in mice through inhalation may range from 1100 milligrams to 3500 milligrams, but may be as high 4000 milligrams due to its slow rate of onset. The lethal dose through inhalation in the average man may vary from 1150 milligrams to 3000 milligrams. HN1 is hardly ever lethal when absorbed through the skin, and the primary function of HN1 in warfare is to produce casualties and injuries. Skin exposure to as little as 100 to 300 milligrams can lead to blisters. Eye exposure to 50 to 100 milligrams can cause severe eye injury.

OVERALL RATING (scale from 1 to 10)	
<i>Effectiveness (as blister agent): 9</i>	<i>Field Stability: 9</i>
<i>Persistence (open area): 9</i>	<i>Storage stability: 7</i>
<i>Persistence (enclosed area): 9</i>	<i>Toxicity (as blister agent): 9</i>
<b>TOTAL EFFECTIVENESS (as blister agent): 8.6</b>	
<b>OVERALL TOXICITY (as warfare agent): 4</b>	

### Procedure 3-008A: Preparation of HN1

**Summary:** HN1 is easily prepared by reacting diethanoethylamine with thionyl chloride in chloroform. The reaction is very vigorous, so the reactants are added slowly with rapid stirring. During the reaction, the corresponding HN1 hydrochloride is formed, which is then recovered by solvent evaporation. The HN1 hydrochloride is then recrystallized from acetone, and then treated with a solution of sodium carbonate in water. The resulting HN1 then separates as a viscous oil. This viscous oil is then removed by decantation, or by a separatory funnel, and then vacuum distilled to yield relatively pure HN1.





Chapter 8: Preparation of Blister Agents  
*Reaction Equation (by products omitted)*

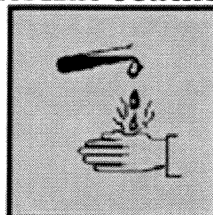
<b>Materials:</b>	1. 60 grams of anhydrous diethanoethylamine	4. 500 milliliters of acetone
	2. 106 grams of thionyl chloride	5. 30 grams of anhydrous sodium carbonate
	3. 700 milliliters of dry chloroform	

**Hazards:**



**WARNING!**

**VIOLENT CONTACT**



**HAZARD**

Do not attempt in anyway to prepare HN1 using the following procedure unless proper safety precautions are taken. 1) Perform all operations in a clean box, in which is completely sealed from the air. Note: A clean box in this case is not needed. HN1 can be safely prepared as long as the maker wears proper gas mask, and nitrile gloves. 2) After each procedure, all glassware and non-electric equipment should be soaked in a hot concentrated sodium hydroxide solution before removing from the clean box, and/or before rinsing and storing. Any electrical equipment that may be contaminated (even if suspected), such as hot plates and stirring equipment should be carefully wiped down with a rag soaked in hot sodium hydroxide solution, followed by wiping down with hot water. 3) The desired HN1 product should be stored in amber bottles, preferably non-breakable containers, and stored in a cool dry place away from sunlight. The bottles should also be placed inside an airtight sealed plastic bag, such as a 'ziplock' bag. 4) Storage of any and all blister agents should be in airtight cabinets, drawers, or the like, and said storage spaces should be equipped with chemical agent detection monitors to alert of any potential leakage.

Use caution when handling thionyl chloride, which reacts violently with water yielding corrosive and toxic fumes.

Use extreme caution when handling HN1 hydrochloride. Note: Sulfur dioxide gas and hydrogen chloride gas is evolved during the reaction; use proper ventilation when carrying out the reaction.

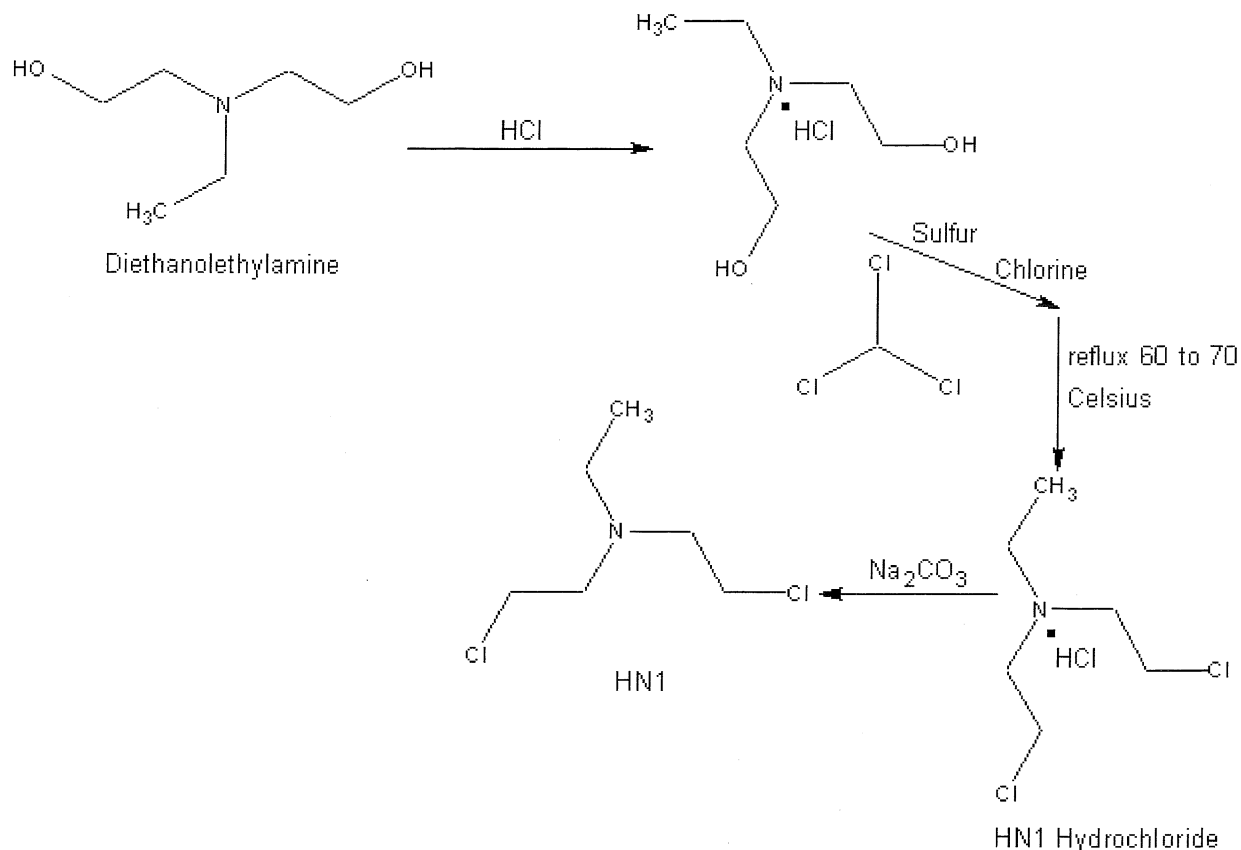
**Procedure:** Into a suitable flask equipped with mechanical stirrer, place 60 grams of anhydrous diethanoethylamine, and then add 500 milliliters of dry chloroform. Thereafter, add and dissolve 106 grams of thionyl chloride, into 200 milliliters of dry chloroform. Then, slowly add drop wise, the thionyl chloride/chloroform mixture to the diethanoethylamine mixture over a period sufficient as to keep the reaction mixture at room temperature. During the addition, rapidly stir the reaction mixture. After the addition, gently reflux the reaction mixture at 60 to 70 Celsius while stirring for about 2 hours. After refluxing for 2 hours, remove the heat source, and allow the reaction mixture to cool to room temperature. Then pour the entire reaction mixture into a rotary evaporator or vacuum distillation apparatus, and remove the chloroform and any excess thionyl chloride under vacuum. After the chloroform has been removed, and dry solid remains, remove the dry solid (which will be HN1 hydrochloride), and then dissolve into 500 milliliters of acetone. Then recrystallize this HN1 hydrochloride solid from the acetone solution. After the recrystallization process, vacuum dry or air-dry the crystalline HN1 hydrochloride product. Then prepare a solution by adding and dissolving 30 grams of anhydrous sodium carbonate into 500 milliliters of cold water. Then place this sodium carbonate solution into a cold-water bath, and then slowly add in portions, the dry HN1 hydrochloride product over a sufficient time as to keep the sodium carbonate solution below 30 Celsius. During the addition, vigorously stir the sodium carbonate solution. After the addition of the HN1 hydrochloride, continue to stir the mixture for about 30 minutes at a temperature below 25 celsius, and then remove the lower HN1 layer using a separatory funnel, or by using decantation. Thereafter, place the HN1 layer into a vacuum distillation apparatus, and vacuum distill under high vacuum and under a temperature of 150 celsius to obtain a refined HN1 product. **Note: The HN1 hydrochloride can be used as a chemical warfare agent by itself if desired. It is similar in effect to straight HN1; HN1 hydrochloride may be absorbed by the skin faster. HN1 hydrochloride can be used as blister agent, as it will produce blisters on the skin within 4 to 18 hours after exposure. To use HN1 hydrochloride, dissolve in water, acetone, or methylene chloride to a concentration of about 1 to 5% by weight, and then use this corresponding solution as is. The solution can be disseminated under the usual techniques, or used in spray bottles as a direct weapon against attackers, or animals. If used as a "mace" type weapon, HN1 hydrochloride will cause severe eye irritation, and blindness to anyone exposed.**

**Procedure 3-008B: Preparation of HN1 (sulfur/chlorine process)**

**Summary:** HN1 can be prepared using a modified process, whereby sulfur and chlorine are the agents responsible for chlorination. Before hand, the diethanoethylamine is converted to the hydrochloride by the action of hydrochloric acid. The resulting mixture is then recrystallized, and the resulting hydrochloride salt then mixed with sulfur, and then treated with chlorine gas. During the chlorine

### Chapter 8: Preparation of Blister Agents

gas addition, the sulfur is oxidized to sulfur monochloride, which in turn then reacts with the diethanoethylamine hydrochloride to produce the HN1 hydrochloride. The HN1 hydrochloride is then converted to the free base, HN1, by the addition of sodium carbonate.



#### Reaction Equation (by products omitted)

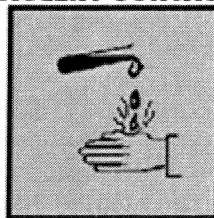
*Materials:	1. 68 grams of diethanoethylamine	5. 64 grams of powdered sulfur
	2. 50 grams of 35 to 38% hydrochloric acid	6. 71 grams of dry chlorine gas
	3. 250 milliliters of dry chloroform	7. 30 grams of anhydrous sodium carbonate
	4. 500 milliliters of acetone	

#### Hazards:



**WARNING!**

#### VIOLENT CONTACT



**HAZARD**

Do not attempt in anyway to prepare HN1 using the following procedure unless proper safety precautions are taken. 1) Perform all operations in a clean box, in which is completely sealed from the air. Note: A clean box in this case is not needed. HN1 can be safely prepared as long as the maker wears proper gas mask, and nitrile gloves. 2) After each procedure, all glassware and non-electric equipment should be soaked in a hot concentrated sodium hydroxide solution before removing from the clean box, and/or before rinsing and storing. Any electrical equipment that may be contaminated (even if suspected), such as hot plates and stirring equipment should be carefully wiped down with a rag soaked in hot sodium hydroxide solution, followed by wiping down with hot water. 3) The desired HN1 product should be stored in amber bottles, preferably non-breakable containers, and stored in a cool dry place away from sunlight. The bottles should also be placed inside an airtight sealed plastic bag, such as a 'ziplock' bag. 4) Storage of any and all blister agents should be in airtight cabinets, drawers, or the like, and said storage spaces should be

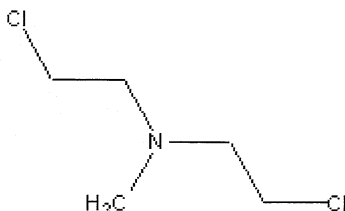
## Chapter 8: Preparation of Blister Agents

equipped with chemical agent detection monitors to alert of any potential leakage.

Use caution when using chlorine gas, which is toxic and corrosive. Use extreme caution when handling HN1 hydrochloride. Note: Sulfur dioxide gas and hydrogen chloride gas is evolved during the reaction; use proper ventilation when carrying out the reaction.

**Procedure:** Into a suitable beaker, add 68 grams of diethanoethylamine, and then add 70 milliliters of water. Thereafter, carefully pour in 50 grams of a 35 to 38% hydrochloric acid solution, while stirring the diethanoethylamine. During the addition, keep the temperature of reaction mixture below 30 Celsius. After the addition, recrystallize the diethanoethylamine hydrochloride from the reaction mixture. After the recrystallization process, vacuum dry or air-dry the filtered-off crystals. Then place these crystals into a suitable flask, and then add 250 milliliters of chloroform. Thereafter add in 64 grams of powdered sulfur, and then assemble an apparatus similar to figure 045 (see HN3). Then rapidly bubble into the reaction mixture, 71 grams of dry chlorine gas while vigorously stirring the reaction mixture. Note: The chlorine addition should take no longer than 6 hours. During the chlorine addition, the reaction mixture temperature may rise to 30 or 40 Celsius. If the temperature of the reaction mixture rises above 50 Celsius, add a cold-water bath to keep the temperature of the reaction mixture below 40 Celsius. After the addition of the chlorine, continue to stir the reaction mixture for 30 minutes, and then reflux the reaction mixture at 60 to 70 Celsius for 1 hour while stirring the reaction mixture. Thereafter, pour the entire reaction mixture into a rotary evaporator, or vacuum distillation apparatus, and remove the chloroform, and liquid impurities via a vacuum until dry solid remains. Once the chloroform has been removed, and dry solid remains, remove the dry solid from the rotary evaporator, or vacuum distillation apparatus, and then recrystallize the crystals from 500 milliliters of acetone. Note: The dry solid will be HN1 hydrochloride. After the recrystallization process, vacuum dry or air-dry the HN1 hydrochloride crystals, and then place them aside for just a moment. During which time, prepare a solution by adding and dissolving 30 grams of anhydrous sodium carbonate into 500 milliliters of cold water, and then place this solution into a cold-water bath. Then gradually add the crystalline HN1 hydrochloride to the sodium carbonate solution while vigorously stirring the sodium carbonate solution. During the addition, HN1 will separate as a viscous oil. After the addition of the HN1 hydrochloride, continue to stir the sodium carbonate mixture for 30 minutes at room temperature, and then remove the lower HN1 layer by using a separatory funnel, or by decantation. Then place the HN1 layer into a vacuum distillation apparatus, and vacuum distill under high vacuum and under a temperature of 150 Celsius to obtain a refined HN1 product. **Note: The HN1 hydrochloride can be used as a chemical warfare agent by itself if desired. It is similar in effect to straight HN1; HN1 hydrochloride may be absorbed by the skin faster. HN1 hydrochloride can be used as a blister agent, as it will produce blisters on the skin within 4 to 12 hours after exposure. To use HN1 hydrochloride, dissolve in water, acetone, or methylene chloride to a concentration of about 1 to 5% by weight, and then use this corresponding solution as is. The solution can be disseminated under the usual techniques, or used in spray bottles as a direct weapon against attackers, or animals. If used as a "mace" type weapon, HN1 hydrochloride will cause severe eye irritation, and blindness to anyone exposed.**

### 03-009. HN2. N-methyl-2,2'-di(chloroethyl) amine; N,N-bis(2-chloroethyl)methamine; 2,2',-dichlorodiethylmethamine



HN2

HN2 forms a mobile, brownish to slight clear, viscous liquid, which may have no odor or a fishy or soapy like odor. The pure liquid is a slightly odorless liquid with a brownish tint. Military grade HN2 is a brown to lightly clear liquid with a slight odor of fish or no odor at all. The impure liquid is a definite brownish color, with a varying odor. It is slightly volatile under normal conditions, and is more volatile than HN3. It is quite persistent in the environment, but less than HN3; its persistence in the environment may be up to 7 days under normal conditions. Under affluent conditions, such as dry and warm climates, HN2 may persist for up to 1 month. HN2 forms a colorless vapor upon evaporation, and will not be detectable in low or even high concentrations by the average soldier. HN2 is insoluble in water, and is only slowly hydrolyzed by it. It is very soluble in oils and many organic solvents, and it is miscible with chloroform, carbon tetrachloride, dimethylformamide, and carbon disulfide. HN2 has a melting point ranging from -30 Celsius to -20 Celsius, depending on purity, and it has a boiling point of 75 Celsius under a vacuum of 15 millimeters of mercury. The stability of HN2 in cold environments is greater than HN3. Like HN3, pure HN2 may polymerize on standing, and stabilization may or may not be needed. For prolonged storage, it should be mixed with chloroform, or methylene chloride. Straight HN2 can be used in military operations with excellent results, either by itself, or when mixed with inert agents such as hydrocarbon waxes, or hydrocarbon oils, and then disseminated properly. Dissemination of pure HN2 may only last for up to 2 weeks in the environment under normal

### Chapter 8: Preparation of Blister Agents

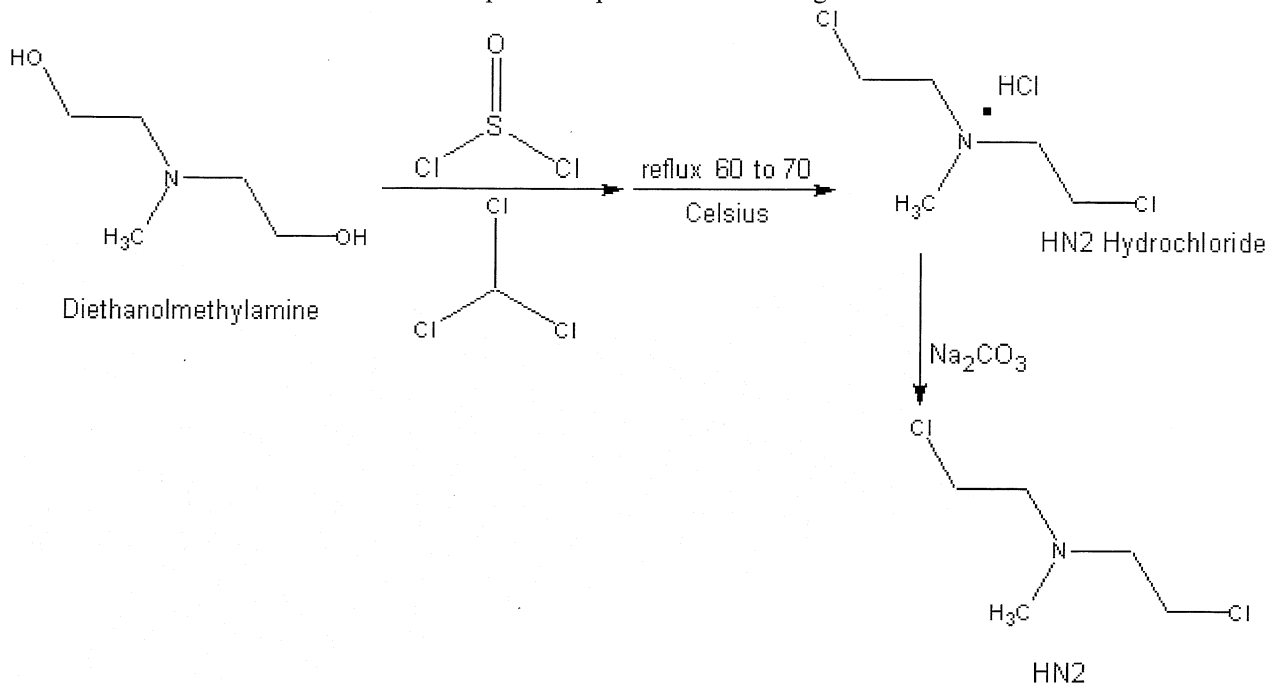
conditions due to volatility and decomposition. HN2 is a deadly vesicant capable of causing blisters anywhere on the body within 4 to 12 hours of exposure. Ordinary clothing has no protective effect to HN2, as it is easily absorbed through ordinary cloths, and then into the skin. Areas that have been contaminated for up to 2 weeks can still render appreciable quantities of HN2 suitable for clothing and then skin absorption. HN2 is much more difficult to decontaminate than the sulfur mustard agents, or nerve agents, and HN2 is up to 3 times more difficult to decontaminate than sulfur mustards. Like HN1 and HN3, HN2 gives absolutely no warning of its presence on the skin, victims exposed to HN2 will not be aware of such an act until 4 to 12 hours later; where upon "burn like" blisters and bruises begin to show up on the skin. Preventing spreading of the contaminated flesh areas can be difficult, and the effected areas should be treated with excessive amounts of a warm solution of concentrated sodium hydroxide, followed by washing with large amounts of soapy hot water (hard water, not soft water). After the washing period, the wounds should be treated with an ointment of an alkali gel made from sodium carbonate and wax, followed by applying clean bandages to said wounds. Untreated, and even treated wounds can leave permanent scarring of the flesh. Wounds caused by HN2 are often slow to heal. Note: HN2 produces blisters after exposure to said agent, and these blister should be immediately scrubbed and broken to remove poisonous fluid. The fluid inside blisters caused by HN2 is poisonous. HN2 is an effective blister agent, and is superior in nature to mustard gas. It can be disseminated from aerosols, explosives munitions, atomizers or humidifiers, or foggers. **HN2 is a delayed action casualty producing agent. Personnel exposed to liquid or vapor will develop burn like blisters and bruises within 4 to 24 hours of exposure. Immediate exposure to agent produces no visual signs, even if exposure is by inhalation. Personnel who inhale or ingest liquid or vapor may suffer violent consequences within hours of exposure. Inhalation of the agent may be fatal within 60 minutes of exposure. Lethal dose for 50% of population in mice through inhalation may range from 1200 milligrams to 3500 milligrams, but may be as high 4000 milligrams due to its slow rate of onset. The lethal dose through inhalation in the average man may vary from 1100 milligrams to 2500 milligrams. HN2 is hardly ever lethal when absorbed through the skin, and the primary function of HN2 in warfare is to produce casualties and injuries. Skin exposure to as little as 100 to 300 milligrams can lead to blisters. Eye exposure to 50 to 100 milligrams can cause severe eye injury.**

OVERALL RATING (scale from 1 to 10)	
<i>Effectiveness (as blister agent): 9</i>	<i>Field Stability: 9</i>
<i>Persistence (open area): 9</i>	<i>Storage stability: 7</i>
<i>Persistence (enclosed area): 9</i>	<i>Toxicity (as blister agent): 9</i>
<b>TOTAL EFFECTIVENESS (as blister agent): 8.6</b>	
<b>OVERALL TOXICITY (as warfare agent): 4</b>	

### Procedure 3-009A: Preparation of HN2

**Summary:** HN2 is easily prepared by reacting diethanolmethylamine with thionyl chloride in chloroform. The reaction is very vigorous, so the reactants are added slowly with rapid stirring. During the reaction, the corresponding HN2 hydrochloride is formed, which is then recovered by solvent evaporation. The HN2 hydrochloride is then recrystallized from acetone, and then treated with a solution of sodium carbonate in water. The resulting HN2 then separates as a viscous oil. This viscous oil is then removed by decantation, or by a separatory funnel, and then vacuum distilled to yield relatively pure HN2.

Chapter 8: Preparation of Blister Agents



*Reaction Equation (by-products omitted)*

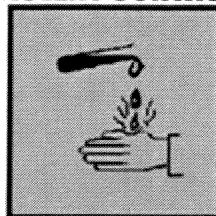
<b>Materials:</b>	1. 75 grams of anhydrous diethanolmethylamine	4. 500 milliliters of acetone
	2. 149 grams of thionyl chloride	5. 40 grams of anhydrous sodium carbonate
	3. 700 milliliters of dry chloroform	

**Hazards:**



**WARNING!**

**VIOLENT CONTACT**



**HAZARD**

Do not attempt in anyway to prepare HN2 using the following procedure unless proper safety precautions are taken. 1) Perform all operations in a clean box, in which is completely sealed from the air. Note: A clean box in this case is not needed. HN2 can be safely prepared as long as the maker wears proper gas mask, and nitrile gloves. 2) After each procedure, all glassware and non-electric equipment should be soaked in a hot concentrated sodium hydroxide solution before removing from the clean box, and/or before rinsing and storing. Any electrical equipment that may be contaminated (even if suspected), such as hot plates and stirring equipment should be carefully wiped down with a rag soaked in hot sodium hydroxide solution, followed by wiping down with hot water. 3) The desired HN2 product should be stored in amber bottles, preferably non-breakable containers, and stored in a cool dry place away from sunlight. The bottles should also be placed inside an airtight sealed plastic bag, such as a 'ziplock' bag. 4) Storage of any and all blister agents should be in airtight cabinets, drawers, or the like, and said storage spaces should be equipped with chemical agent detection monitors to alert of any potential leakage.

Use caution when handling thionyl chloride, which reacts violently with water yielding corrosive and toxic fumes.

Use extreme caution when handling HN2 hydrochloride. Note: Sulfur dioxide gas and hydrogen chloride gas is evolved during the reaction; use proper ventilation when carrying out the reaction.

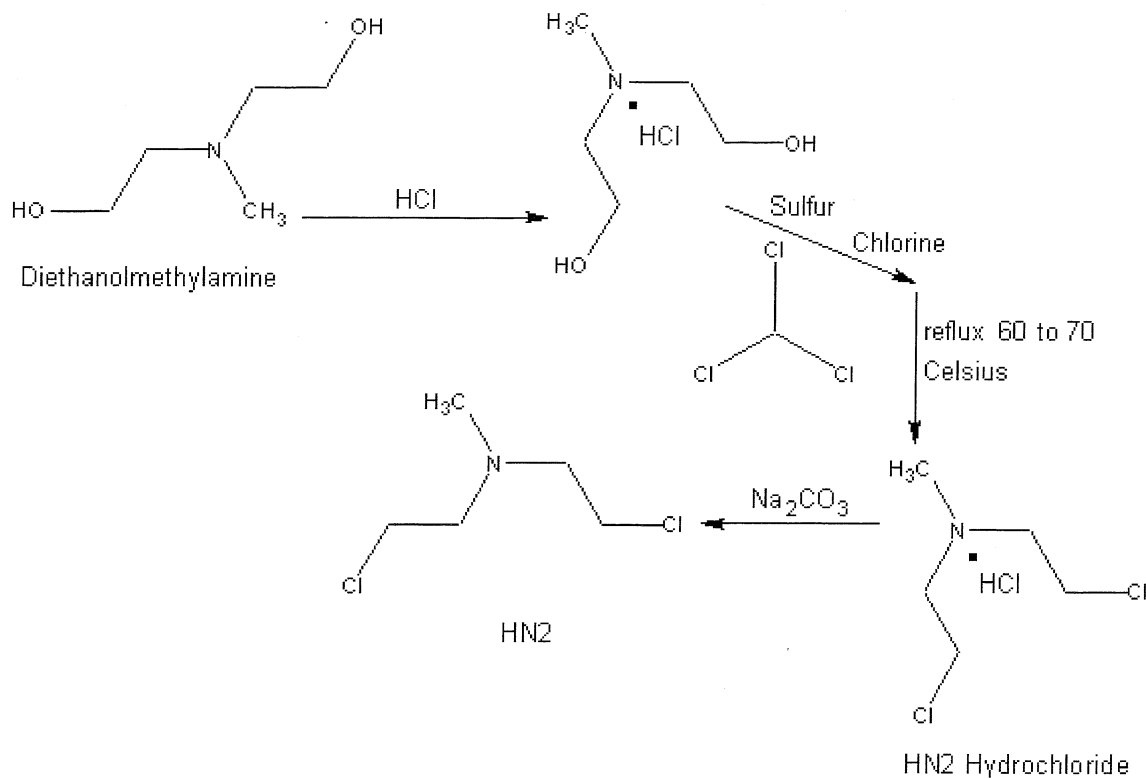
**Procedure:** Into a suitable flask equipped with mechanical stirrer, place 75 grams of anhydrous diethanolmethylamine, and then add 500 milliliters of dry chloroform. Thereafter, add and dissolve 149 grams of thionyl chloride, into 200 milliliters of dry chloroform. Then, slowly add drop wise, the thionyl chloride/chloroform mixture to the diethanolmethylamine mixture over a period sufficient as

### Chapter 8: Preparation of Blister Agents

to keep the reaction mixture at room temperature. During the addition, rapidly stir the reaction mixture. After the addition, gently reflux the reaction mixture at 60 to 70 Celsius while stirring for about 2 hours. After refluxing for 2 hours, remove the heat source, and allow the reaction mixture to cool to room temperature. Then pour the entire reaction mixture into a rotary evaporator or vacuum distillation apparatus, and remove the chloroform and any excess thionyl chloride under vacuum. After the chloroform has been removed, and dry solid remains, remove the dry solid (which will be HN2 hydrochloride), and then dissolve into 500 milliliters of acetone. Then recrystallize this HN2 hydrochloride solid from the acetone solution. After the recrystallization process, vacuum dry or air-dry the crystalline HN2 hydrochloride product. Then prepare a solution by adding and dissolving 40 grams of anhydrous sodium carbonate into 500 milliliters of cold water. Then place this sodium carbonate solution into a cold-water bath, and then slowly add in portions, the dry HN2 hydrochloride product over a sufficient time as to keep the sodium carbonate solution below 30 Celsius. During the addition, vigorously stir the sodium carbonate solution. After the addition of the HN2 hydrochloride, continue to stir the mixture for about 30 minutes at a temperature below 25 Celsius, and then remove the lower HN2 layer using a separatory funnel, or by using decantation. Thereafter, place the HN2 layer into a vacuum distillation apparatus, and vacuum distill at 75 Celsius under a vacuum of 15 millimeters of mercury to obtain a refined HN2 product. **Note: The HN2 hydrochloride can be used as a chemical warfare agent by itself if desired. It is similar in effect to straight HN2; HN2 hydrochloride may be absorbed by the skin faster. HN2 hydrochloride can be used as blister agent, as it will produce blisters on the skin within 4 to 12 hours after exposure. To use HN2 hydrochloride, dissolve in water, acetone, or methylene chloride to a concentration of about 1 to 5% by weight, and then use this corresponding solution as is. The solution can be disseminated under the usual techniques, or used in spray bottles as a direct weapon against attackers, or animals. If used as a "mace" type weapon, HN2 hydrochloride will cause severe eye irritation, and blindness to anyone exposed.**

#### Procedure 3-009B: Preparation of HN2 (sulfur/chlorine process)

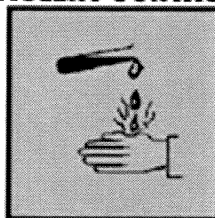
**Summary:** HN2 can be prepared using a modified process, whereby sulfur and chlorine are the agents responsible for chlorination. Before hand, the diethanolmethylamine is converted to the hydrochloride by the action of hydrochloric acid. The resulting mixture is then recrystallized, and the resulting hydrochloride salt then mixed with sulfur, and then treated with chlorine gas. During the chlorine gas addition, the sulfur is oxidized to sulfur monochloride, which in turn then reacts with the diethanolmethylamine hydrochloride to produce the HN2 hydrochloride. The HN2 hydrochloride is then converted to the free base, HN2, by the addition of sodium carbonate.



#### Reaction Equation (by products omitted)

<b>Materials:</b>	1. 61 grams of diethanolmethylamine	5. 65 grams of powdered sulfur
	2. 50 grams of 35 to 38% hydrochloric acid	6. 72 grams of dry chlorine gas
	3. 250 milliliters of dry chloroform	7. 30 grams of anhydrous sodium carbonate

4. 500 milliliters of acetone

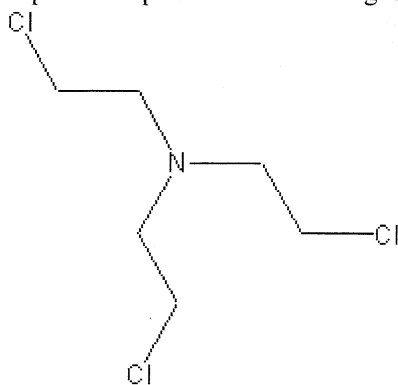
**Hazards:****WARNING!****VIOLENT CONTACT****HAZARD**

Do not attempt in anyway to prepare HN2 using the following procedure unless proper safety precautions are taken. 1) Perform all operations in a clean box, in which is completely sealed from the air. Note: A clean box in this case is not needed. HN2 can be safely prepared as long as the maker wears proper gas mask, and nitrile gloves. 2) After each procedure, all glassware and non-electric equipment should be soaked in a hot concentrated sodium hydroxide solution before removing from the clean box, and/or before rinsing and storing. Any electrical equipment that may be contaminated (even if suspected), such as hot plates and stirring equipment should be carefully wiped down with a rag soaked in hot sodium hydroxide solution, followed by wiping down with hot water. 3) The desired HN2 product should be stored in amber bottles, preferably non-breakable containers, and stored in a cool dry place away from sunlight. The bottles should also be placed inside an airtight sealed plastic bag, such as a 'ziplock' bag. 4) Storage of any and all blister agents should be in airtight cabinets, drawers, or the like, and said storage spaces should be equipped with chemical agent detection monitors to alert of any potential leakage.

Use caution when using chlorine gas, which is toxic and corrosive. Use extreme caution when handling HN2 hydrochloride. Note: Sulfur dioxide gas and hydrogen chloride gas is evolved during the reaction; use proper ventilation when carrying out the reaction.

**Procedure:** Into a suitable beaker, add 61 grams of diethanolmethylamine, and then add 60 milliliters of water. Thereafter, carefully pour in 50 grams of a 35 to 38% hydrochloric acid solution, while stirring the diethanolmethylamine. During the addition, keep the temperature of reaction mixture below 30 Celsius. After the addition, recrystallize the diethanolmethylamine hydrochloride from the reaction mixture. After the recrystallization process, vacuum dry or air-dry the filtered-off crystals. Then place these crystals into a suitable flask, and then add 250 milliliters of chloroform. Thereafter add in 65 grams of powdered sulfur, and then assemble the apparatus similar to figure 045 (see HN3). Then rapidly bubble into the reaction mixture, 72 grams of dry chlorine gas while vigorously stirring the reaction mixture. Note: The chlorine addition should take no longer then 6 hours. During the chlorine addition, the reaction mixtures temperature may rise to 30 or 40 Celsius. If the temperature of the reaction mixture rises above 50 Celsius, add a cold-water bath to keep the temperature of the reaction mixture below 40 Celsius. After the addition of the chlorine, continue to stir the reaction mixture for 30 minutes, and then reflux the reaction mixture at 60 to 70 Celsius for 1 hour while stirring the reaction mixture. Thereafter, pour the entire reaction mixture into a rotary evaporator, or vacuum distillation apparatus, and remove the chloroform, and liquid impurities via a vacuum until dry solid remains. Once the chloroform has been removed, and dry solid remains, remove the dry solid from the rotary evaporator, or vacuum distillation apparatus, and then recrystallize the crystals from 500 milliliters of acetone. Note: The dry solid will be HN2 hydrochloride. After the recrystallization process, vacuum dry or air-dry the HN2 hydrochloride crystals, and then place them aside for just a moment. During which time, prepare a solution by adding and dissolving 30 grams of anhydrous sodium carbonate into 500 milliliters of cold water, and then place this solution into a cold-water bath. Then gradually add the crystalline HN2 hydrochloride to the sodium carbonate solution while vigorously stirring the sodium carbonate solution. During the addition, HN2 will separate as a viscous oil. After the addition of the HN2 hydrochloride, continue to stir the sodium carbonate mixture for 30 minutes at room temperature, and then remove the lower HN2 layer by using a separatory funnel, or by decantation. Then place the HN2 layer into a vacuum distillation apparatus, and vacuum distill at 75 Celsius and under a vacuum of 15 millimeters of mercury. Note: **The HN2 hydrochloride can be used as a chemical warfare agent by itself if desired. It is similar in effect to straight HN2; HN2 hydrochloride may be absorbed by the skin faster. HN2 hydrochloride can be used as a blister agent, as it will produce blisters on the skin within 4 to 12 hours after exposure. To use HN2 hydrochloride, dissolve in water, acetone, or methylene chloride to a concentration of about 1 to 5% by weight, and then use this corresponding solution as is. The solution can be disseminated under the usual techniques, or used in spray bottles as a direct weapon against attackers, or animals. If used as a "mace" type weapon, HN2 hydrochloride will cause severe eye irritation, and blindness to anyone exposed.**

**03-10. HN3. tris(beta-chloroethyl)amine; 2-Chloro-N,N-bis(2-chloroethyl)ethaneamine; 2,2',2''-Trichlorotriethylamine**



HN3

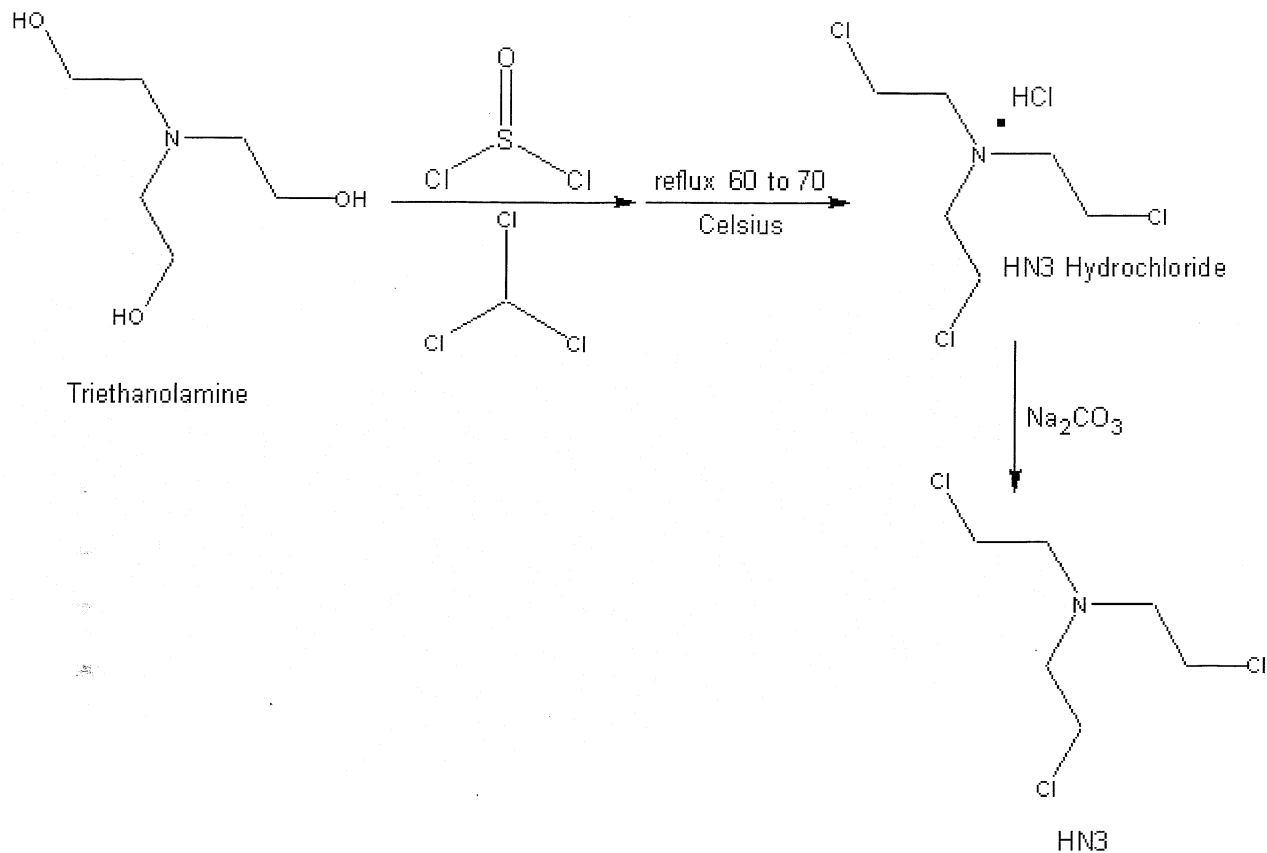
HN3 forms a mobile, brownish viscous liquid with a fishy-soapy odor. The pure liquid is a slightly odorless liquid with a brown tint. Military grade HN3 is a brown to muddy liquid with a slight odor of fish and hand soap. The impure liquid is a definite brownish color, with an odor of fish. It is slightly volatile under normal conditions, and is quite persistent in the environment; its persistence in the environment may be up to 7 days under normal conditions. Under affluent conditions, such as dry and warm climates, HN3 may persist for up to 2 months. HN3 forms a colorless vapor upon evaporation, and will not be detectable in low or even high concentrations by the average soldier. HN3 is insoluble in water, and is only slowly hydrolyzed by it. It is very soluble in oils and many organic solvents, and it is miscible with chloroform, carbon tetrachloride, dimethylformamide, and carbon disulfide. HN3 has a melting point of  $-4$  Celsius, and a boiling point of 144 Celsius under a vacuum of 15 millimeters of mercury. Because of HN3's relatively high melting point, it must be mixed other compounds, such as thickeners to decrease its melting point to allow for greater stability in cold environments. Pure HN3 tends to polymerize on standing, and should be stabilized with the addition of 1 to 10% chloroform by weight. For prolonged storage, it should be mixed with chloroform, or methylene chloride. For use in chemical warfare where a strict vesicant action is desired, HN3 should be diluted with sulfur mustards such as mustard gas for use in military operations. Straight HN3 can be used in military operations with excellent results, either by itself, or when mixed with inert agents such as hydrocarbon waxes, or hydrocarbon oils, and then disseminated properly. Dissemination of pure HN3 may only last for up to 2 to 4 weeks in the environment under normal conditions. HN3 is a deadly vesicant capable of causing blisters anywhere on the body within 4 to 12 hours of exposure. Ordinary clothing has no protective effect against HN3, as it is easily absorbed through ordinary clothing, and then into the skin. Even areas that have been contaminated for up to 2 months can still render appreciable quantities of HN3 suitable for clothing and then skin absorption. HN3 is much more difficult to decontaminate than the other blister agents, or nerve agents, and HN3 is up to 5 times more difficult to decontaminate than the sulfur mustards. Because HN3 gives absolutely no warning of its presence on the skin, victims exposed to HN3 will not be aware of such an act until 4 to 12 hours later; where upon "burn like" blisters and bruises begin to show up on the skin. By this time, decontamination is relatively too late, and the only thing left to do is prevent spreading of the contaminated flesh areas. Preventing spreading can be difficult, and the effected areas should be treated with excessive amounts of a warm solution of concentrated sodium hydroxide, followed by washing with large amounts of soapy hot water. After the washing period, the wounds should be treated with an ointment of an alkali gel made from sodium carbonate and wax, followed by applying clean bandages to said wounds. Applying a dilute phenol solution can help relieve any pain associated with said wounds. Untreated, and even treated wounds can leave permanent scarring of the flesh. Note: HN3 produces blisters after exposure to said agent, and these blisters should be immediately scrubbed and broken to remove poisonous fluid. The fluid inside blisters caused by HN3 is poisonous. HN3 is by far the most effective blister agent known to man. **HN3 is a delayed action casualty producing agent. Personnel exposed to liquid or vapor will develop burn like blisters and bruises within 4 to 24 hours of exposure. Immediate exposure to agent produces no visual signs, even if exposure is by inhalation. Personnel who inhale or ingest liquid or vapor may suffer violent consequences within hours of exposure. Inhalation of the agent may be fatal within 60 minutes of exposure. Lethal dose for 50% of population in mice through inhalation may range from 1200 milligrams to 1500 milligrams. The lethal dose through inhalation in the average man may vary from 1000 milligrams to 1500 milligrams. HN3 is hardly ever lethal when absorbed through the skin, and the primary function of HN3 in warfare is to produce casualties and injuries. Skin exposure to as little as 100 to 300 milligrams can lead to blisters. Eye exposure to 50 to 100 milligrams can cause severe eye injury.**

OVERALL RATING (scale from 1 to 10)	
<i>Effectiveness (as blister agent):</i> 10	<i>Field Stability:</i> 10
<i>Persistence (open area):</i> 9	<i>Storage stability:</i> 7
<i>Persistence (enclosed area):</i> 10	<i>Toxicity (as blister agent):</i> 10
<b>TOTAL EFFECTIVENESS (as blister agent):</b> 9.3	
<b>OVERALL TOXICITY (as warfare agent):</b> 4½	



Chapter 8: Preparation of Blister Agents  
**Procedure 3-010A: Preparation of HN3**

**Summary:** HN3 is easily prepared by reacting triethanolamine with thionyl chloride in chloroform. The reaction is very vigorous, so the reactants are added slowly with rapid stirring. During the reaction, the corresponding HN3 hydrochloride is formed, which is then recovered by solvent evaporation. The HN3 hydrochloride is then recrystallized from acetone, and then treated with a solution of sodium carbonate in water. The resulting HN3 then separates as brownish, viscous oil. This viscous oil is then removed by decantation, or by a separatory funnel, and then vacuum distilled to yield relatively pure HN3. Note: The preparation of HN3 discussed in this procedure is similar or related to the process discussed in serial number 714,095 March 5<sup>th</sup>, 1934 by Kyle Ward, Jr., of Wilmington, Del.; assigned to Hercules Powder Company. This process may be protected by industrial/commercial process applications. Consult said application number before using the mentioned process for commercial or industrial purposes.



*Reaction Equation (by-products omitted)*

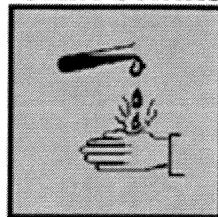
<b>Materials:</b>	1. 61.5 milliliters of anhydrous triethanolamine	4. 500 milliliters of acetone
	2. 135 milliliters of thionyl chloride	5. 30 grams of anhydrous sodium carbonate
	3. 700 milliliters of dry chloroform	

**Hazards:**



**WARNING!**

**VIOLENT CONTACT**



**HAZARD**

Do not attempt in anyway to prepare HN3 using the following procedure unless proper safety precautions are taken. 1) Perform all operations in a clean box, in which is completely sealed from the air. Note: A clean box in this case is not needed. HN3 can be safely prepared as long as the maker wears proper gas mask, and nitrile gloves. 2) After each

## Chapter 8: Preparation of Blister Agents

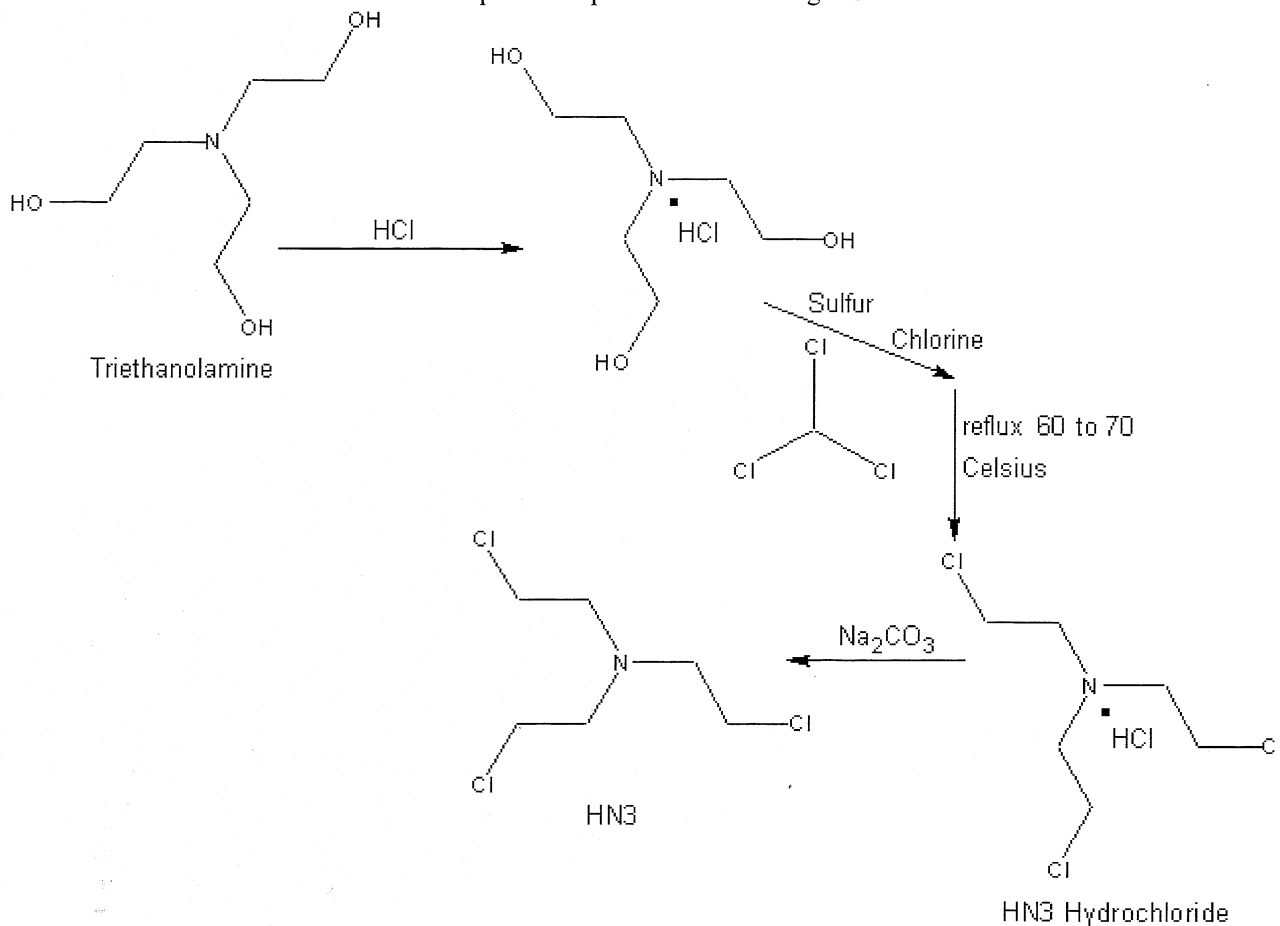
procedure, all glassware and non-electric equipment should be soaked in a hot concentrated sodium hydroxide solution before removing from the clean box, and/or before rinsing and storing. Any electrical equipment that may be contaminated (even if suspected), such as hot plates and stirring equipment should be carefully wiped down with a rag soaked in hot sodium hydroxide solution, followed by wiping down with hot water. 3) The desired HN3 product should be stored in amber bottles, preferably non-breakable containers, and stored in a cool dry place away from sunlight. The bottles should also be placed inside an airtight sealed plastic bag, such as a 'ziplock' bag. 4) Storage of any and all blister agents should be in airtight cabinets, drawers, or the like, and said storage spaces should be equipped with chemical agent detection monitors to alert of any potential leakage. Use caution when handling thionyl chloride, which reacts violently with water yielding corrosive and toxic fumes. Use extreme caution when handling HN3 hydrochloride. Note: Sulfur dioxide gas and hydrogen chloride gas is evolved during the reaction; use proper ventilation when carrying out the reaction.

**Procedure:** Into a suitable flask equipped with mechanical stirrer, place 61.5 milliliters of anhydrous triethanolamine, and then add 500 milliliters of dry chloroform. Thereafter, add and dissolve 135 milliliters of thionyl chloride, into 200 milliliters of dry chloroform. Then, slowly add drop wise, the thionyl chloride/chloroform mixture to the triethanolamine mixture over a period sufficient as to keep the reaction mixture at room temperature. During the addition, rapidly stir the reaction mixture. After the addition, gently reflux the reaction mixture at 60 to 70 Celsius while stirring for about 2 hours. After refluxing for 2 hours, remove the heat source, and allow the reaction mixture to cool to room temperature. Then pour the entire reaction mixture into a rotary evaporator or vacuum distillation apparatus, and remove the chloroform and any excess thionyl chloride under vacuum. After the chloroform has been removed, and dry solid remains, remove the dry solid (which will be HN3 hydrochloride), and then dissolve into 500 milliliters of acetone. Then recrystallize this HN3 hydrochloride solid from the acetone solution. After the recrystallization process, vacuum dry or air-dry the crystalline HN3 hydrochloride product. Then prepare a solution by adding and dissolving 30 grams of anhydrous sodium carbonate into 500 milliliters of cold water. Then place this sodium carbonate solution into a cold-water bath, and then slowly add in portions, the dry HN3 hydrochloride product over a sufficient time as to keep the sodium carbonate solution below 30 Celsius. During the addition, vigorously stir the sodium carbonate solution. After the addition of the HN3 hydrochloride, continue to stir the mixture for about 30 minutes at a temperature below 25 Celsius, and then remove the lower HN3 layer using a separatory funnel, or by using decantation. Thereafter, place the HN3 layer into a vacuum distillation apparatus, and vacuum distill at 144 Celsius under a vacuum of 15 millimeters of mercury to obtain a refined HN3 product. **Note: The HN3 hydrochloride can be used as a chemical warfare agent by itself if desired. It is similar in effect to straight HN3; HN3 hydrochloride may be absorbed by the skin faster. HN3 hydrochloride can be used as blister agent, as it will produce blisters on the skin within 4 to 12 hours after exposure. To use HN3 hydrochloride, dissolve in water, acetone, or methylene chloride to a concentration of about 1 to 5% by weight, and then use this corresponding solution as is. The solution can be disseminated under the usual techniques, or used in spray bottles as a direct weapon against attackers, or animals. If used as a "mace" type weapon, HN3 hydrochloride will cause severe eye irritation, and blindness to anyone exposed.**

### **Procedure 3-010B: Preparation of HN3 (sulfur/chlorine process)**

**Summary:** HN3 can be prepared using a modified process, whereby sulfur and chlorine are the agents responsible for chlorination. Before hand, the triethanolamine is converted to the hydrochloride by the action of hydrochloric acid. The resulting mixture is then recrystallized, and the resulting hydrochloride salt then mixed with sulfur, and then treated with chlorine gas. During the chlorine gas addition, the sulfur is oxidized to sulfur monochloride, which in turn then reacts with the triethanolamine hydrochloride to produce the HN3 hydrochloride. The HN3 hydrochloride is then converted to the free base, HN3, by the addition of sodium carbonate.

Chapter 8: Preparation of Blister Agents



*Reaction Equation (by products omitted)*

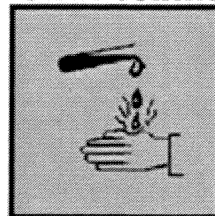
<b>Materials:</b>	1. 70 grams of triethanolamine	5. 45 grams of powdered sulfur
	2. 45 grams of 35 to 38% hydrochloric acid	6. 50 grams of dry chlorine gas
	3. 250 milliliters of dry chloroform	7. 25 grams of anhydrous sodium carbonate
	4. 500 milliliters of acetone	

**Hazards:**



**WARNING!**

**VIOLENT CONTACT**



**HAZARD**

Do not attempt in anyway to prepare HN<sub>3</sub> using the following procedure unless proper safety precautions are taken. 1) Perform all operations in a clean box, in which is completely sealed from the air. Note: A clean box in this case is not needed. HN<sub>3</sub> can be safely prepared as long as the maker wears proper gas mask, and nitrile gloves. 2) After each procedure, all glassware and non-electric equipment should be soaked in a hot concentrated sodium hydroxide solution before removing from the clean box, and/or before rinsing and storing. Any electrical equipment that may be contaminated (even if suspected), such as hot plates and stirring equipment should be carefully wiped down with a rag soaked in hot sodium hydroxide solution, followed by wiping down with hot water. 3) The desired HN<sub>3</sub> product should be stored in amber bottles, preferably non-breakable containers, and stored in a cool dry place away from sunlight. The bottles should also be placed inside an airtight sealed plastic bag, such as a 'ziplock' bag. 4) Storage of any and all blister agents should be in airtight cabinets, drawers, or the like, and said storage spaces should be equipped with chemical agent detection monitors to alert of any potential leakage.

## Chapter 8: Preparation of Blister Agents

Use caution when using chlorine gas, which is toxic and corrosive. Use extreme caution when handling HN3 hydrochloride. Note: Sulfur dioxide gas and hydrogen chloride gas is evolved during the reaction; use proper ventilation when carrying out the reaction.

**Procedure:** Into a suitable beaker, add 70 grams of triethanolamine, and then add 70 milliliters of water. Thereafter, carefully pour in 45 grams of a 35 to 38% hydrochloric acid solution, while stirring the triethanolamine. During the addition, keep the temperature of reaction mixture below 30 Celsius. After the addition, recrystallize the triethanolamine hydrochloride from the reaction mixture. After the recrystallization process, vacuum dry or air-dry the filtered-off crystals. Then place these crystals into a suitable flask, and then add 250 milliliters of chloroform. Thereafter add in 45 grams of powdered sulfur, and then assemble the apparatus is figure 045. Then rapidly bubble into the reaction mixture, 50 grams of dry chlorine gas while vigorously stirring the reaction mixture. Note: The chlorine addition should take no longer than 6 hours. During the chlorine addition, the reaction mixture temperature may rise to 30 or 40 Celsius. If the temperature of the reaction mixture rises above 50 Celsius, add a cold-water bath to keep the temperature of the reaction mixture below 40 Celsius. After the addition of the chlorine, continue to stir the reaction mixture for 30 minutes, and then reflux the reaction mixture at 60 to 70 Celsius for 1 hour while stirring the reaction mixture. Thereafter, pour the entire reaction mixture into a rotary evaporator, or vacuum distillation apparatus, and remove the chloroform, and liquid impurities via a vacuum until dry solid remains. Once the chloroform has been removed, and dry solid remains, remove the dry solid from the rotary evaporator, or vacuum distillation apparatus, and then recrystallize the crystals from 500 milliliters of acetone. Note: The dry solid will be HN3 hydrochloride. After the recrystallization process, vacuum dry or air-dry the HN3 hydrochloride crystals, and then place them aside for just a moment. During which time, prepare a solution by adding and dissolving 25 grams of anhydrous sodium carbonate into 400 milliliters of cold water, and then place this solution into a cold-water bath. Then gradually add the crystalline HN3 hydrochloride to the sodium carbonate solution while vigorously stirring the sodium carbonate solution. During the addition, HN3 will separate as a viscous oil. After the addition of the HN3 hydrochloride, continue to stir the sodium carbonate mixture for 30 minutes at room temperature, and then remove the lower HN3 layer by using a separatory funnel, or by decantation. Then place the HN3 layer into vacuum distillation apparatus, and vacuum distill at 144 Celsius and under a vacuum of 15 millimeters of mercury. **Note: The HN3 hydrochloride can be used as a chemical warfare agent by itself if desired. It is similar in effect to straight HN3; HN3 hydrochloride may be absorbed by the skin faster. HN3 hydrochloride can be used as blister agent, as it will produce blisters on the skin within 4 to 12 hours after exposure. To use HN3 hydrochloride, dissolve in water, acetone, or methylene chloride to a concentration of about 1 to 5% by weight, and then use this corresponding solution as is. The solution can be disseminated under the usual techniques, or used in spray bottles as a direct weapon against attackers, or animals. If used as a "mace" type weapon, HN3 hydrochloride will cause severe eye irritation, and blindness to anyone exposed.**

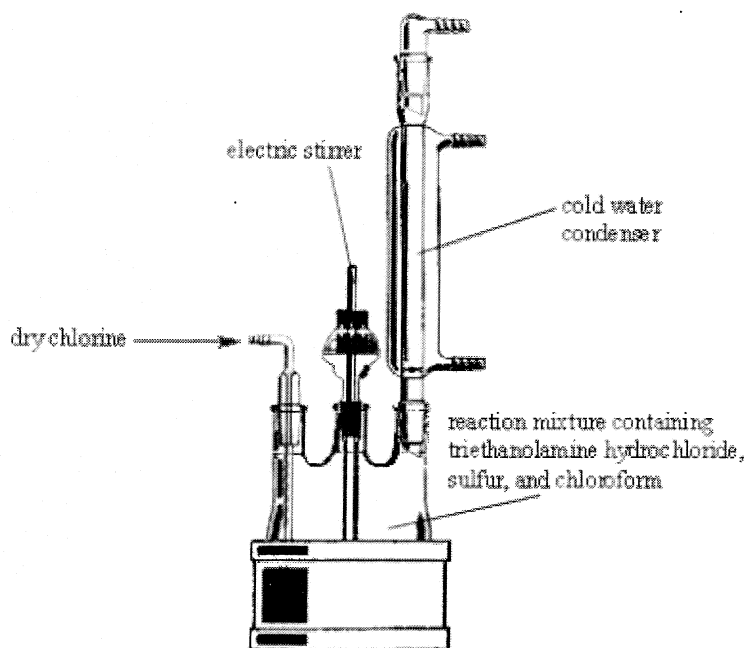
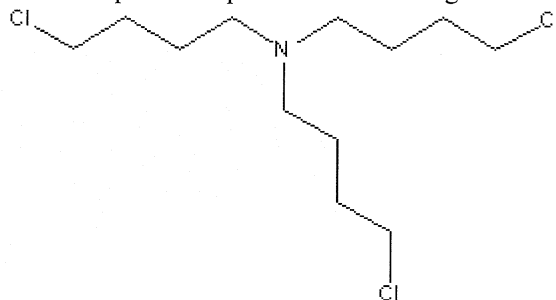


Figure 045. Reaction apparatus for chlorine addition.

**03-011. HN4. tris(beta-chlorobutyl)amine; 2-Chloro-N,N-bis(2-chlorobutyl)butaneamine; 2,2',2''-Trichlorotributylamine**



HN4

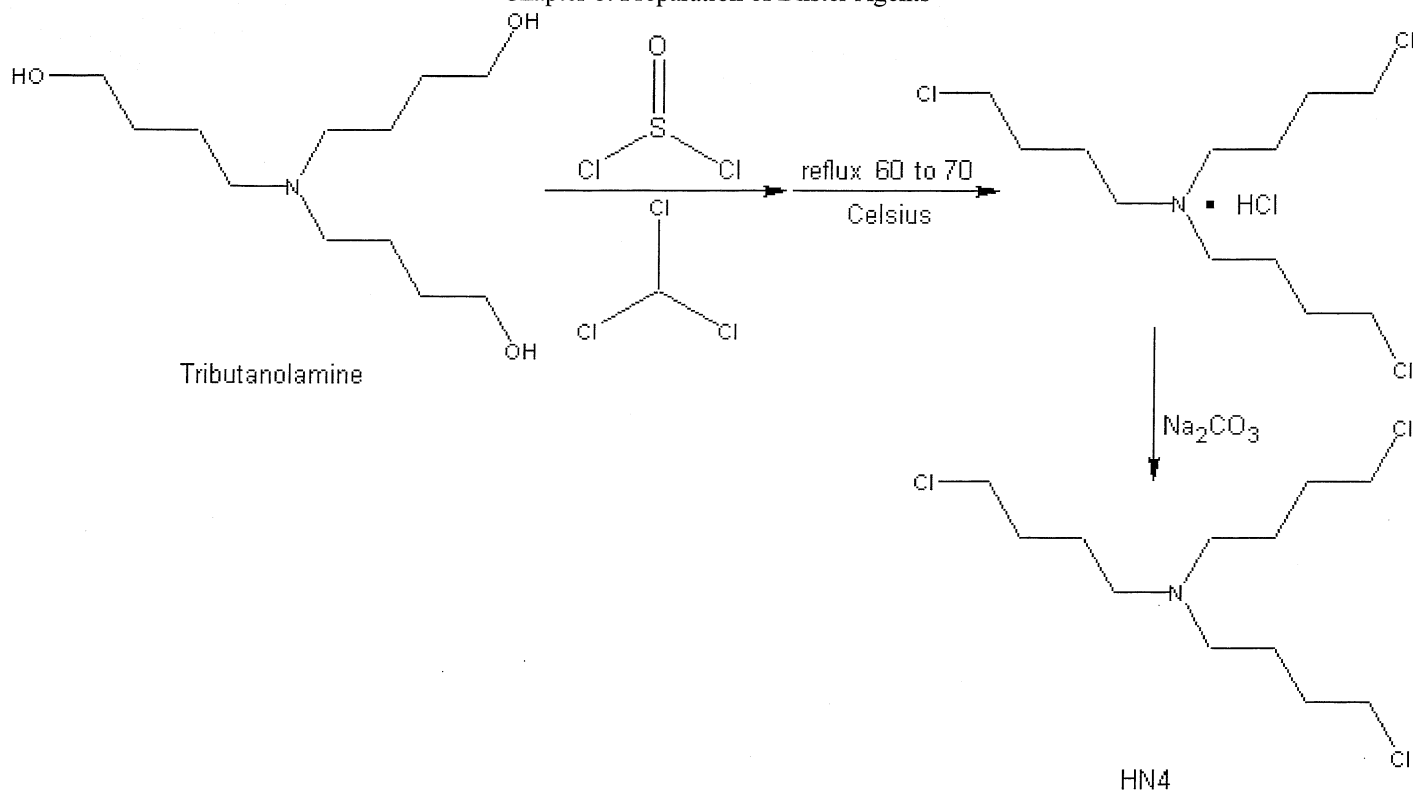
HN4 is a colorless to brownish colored crystalline solid, or colorless to amber-brown semi solid liquid. Its odor is similar to HN3. HN4 has similar properties to HN3, but its melting point is much higher; as a result, it can be disseminated from of smoke generating compositions. Dissemination in the form of smoke can render HN4 very effective in tactical military operations where contamination of large areas of environment is not desired. Such munitions for dissemination may be grenades, and rockets. It can be disseminated from aerosols, explosives munitions, and foggers. HN4 can also disseminated in solution with inert solvents, and can be used to contaminate large areas of the environment. Because HN4 is a crystalline solid, it may stick to any known surface upon solvent evaporation, rendering an interesting form of contamination (similar to the solid residue sometimes visible on fruit). This residue can contaminate leaves, berries, tree limbs, and most equipment with said agent, leading to contamination to anyone who may brush up to the vegetation or contaminated equipment; the HN4 will contaminate the clothing in question, and the agent on said clothing will then be absorbed through the clothing and then into the skin. Symptoms of skin exposure are similar to HN3, with a delayed effect of up to 32 hours. Environments, i.e. vegetation contaminated with HN4 can remain contaminated for up to 1 month under normal conditions. Decontamination of HN4 is relatively difficult, and total decontamination of environments is nearly impossible. Symptoms of exposure are similar to HN3. **HN4 is a delayed action casualty producing agent. Personnel exposed to liquid or vapor will develop burn like blisters and bruises within 4 to 32 hours of exposure. Immediate exposure to agent produces no visual signs, even by inhalation. Personnel who inhale or ingest liquid or vapor may suffer violent consequences, several hours after exposure. Inhalation of the agent is potentially fatal within 60 minutes of exposure. Lethal dose for 50% of population in mice through inhalation may range from 1100 milligrams to 2500 milligrams. The lethal dose through inhalation in the average man may vary from 1200 milligrams to 2200 milligrams. Skin exposure to as little as 100 to 300 milligrams can lead to blisters. Eye exposure to 50 to 100 milligrams can cause severe eye injury. HN4 is hardly ever lethal when absorbed through the skin.**

OVERALL RATING (scale from 1 to 10)	
<i>Effectiveness (as blister agent):</i> 8	<i>Field Stability:</i> 10
<i>Persistence (open area):</i> 10	<i>Storage stability:</i> 7
<i>Persistence (enclosed area):</i> 10	<i>Toxicity (as blister agent):</i> 8
<b>TOTAL EFFECTIVENESS (as blister agent): 8.8</b>	
<b>OVERALL TOXICITY (as warfare agent): 3¾</b>	

### Procedure 3-011A: Preparation of HN4

**Summary:** HN4 is easily prepared using a similar reaction as to HN1, HN2, and HN3. It can be made by reacting tributanolamine with thionyl chloride in chloroform. The reaction is very vigorous, so the reactants are added slowly with rapid stirring. During the reaction, the corresponding HN4 hydrochloride is formed, which is then recovered by solvent evaporation. The HN4 hydrochloride is then recrystallized from acetone, and then treated with a solution of sodium carbonate in water. The resulting HN4 then separates as brownish, to colorless crystals. These crystals are then recovered by filtration, washed, and then dried.

Chapter 8: Preparation of Blister Agents



*Reaction Equation (by-products omitted)*

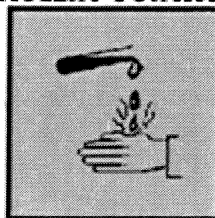
<b>Materials:</b>	1. 70 grams of anhydrous tributanolamine	4. 500 milliliters of acetone
	2. 107 grams of thionyl chloride	5. 20 grams of anhydrous sodium carbonate
	3. 700 milliliters of dry chloroform	

**Hazards:**



**WARNING!**

**VIOLENT CONTACT**



**HAZARD**

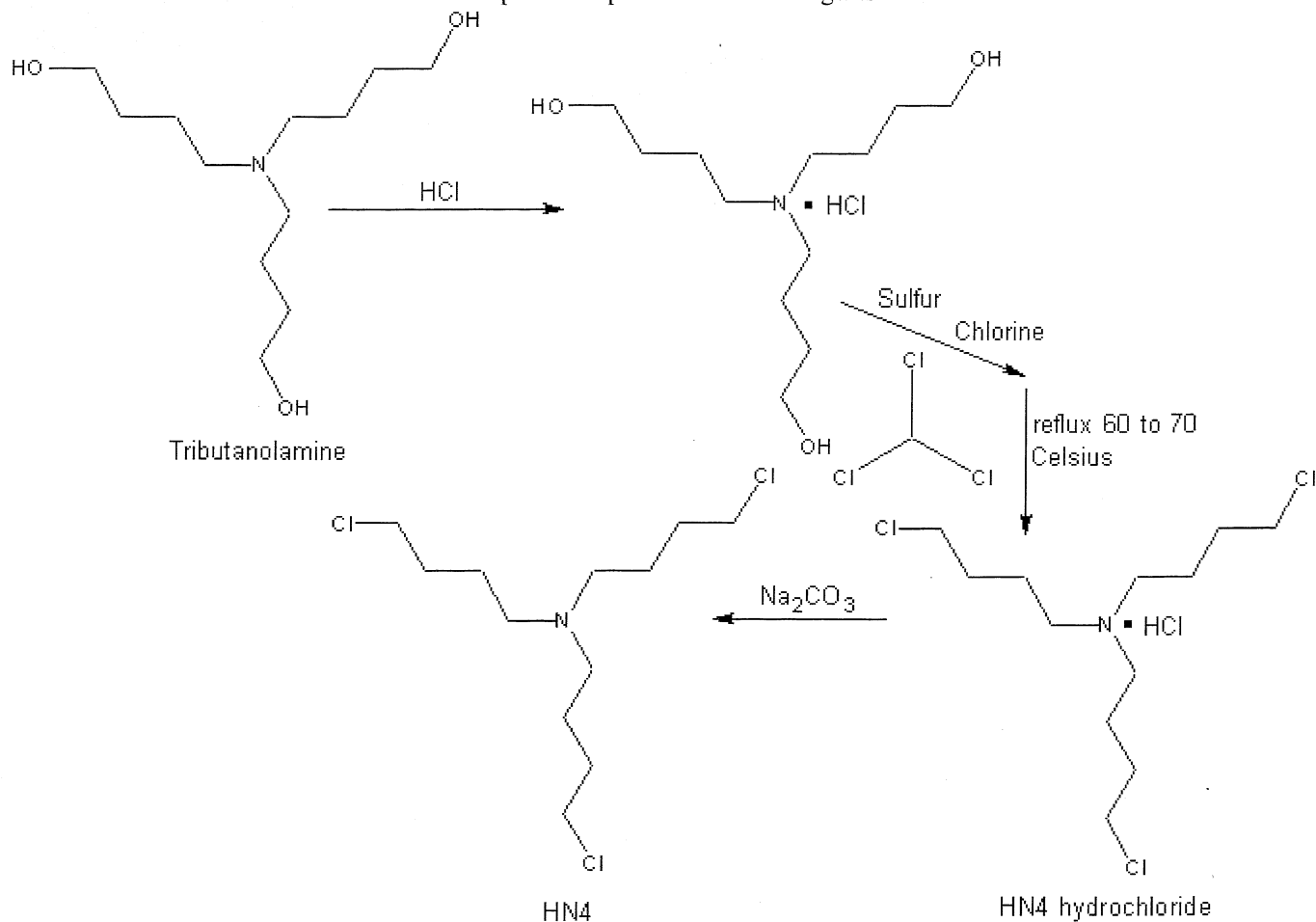
Do not attempt in anyway to prepare HN4 using the following procedure unless proper safety precautions are taken. 1) Perform all operations in a clean box, in which is completely sealed from the air. Note: A clean box in this case is not needed. HN4 can be safely prepared as long as the maker wears proper gas mask, and nitrile gloves. 2) After each procedure, all glassware and non-electric equipment should be soaked in a hot concentrated sodium hydroxide solution before removing from the clean box, and/or before rinsing and storing. Any electrical equipment that may be contaminated (even if suspected), such as hot plates and stirring equipment should be carefully wiped down with a rag soaked in hot sodium hydroxide solution, followed by wiping down with hot water. 3) The desired HN4 product should be stored in amber bottles, preferably non-breakable containers, and stored in a cool dry place away from sunlight. The bottles should also be placed inside an airtight sealed plastic bag, such as a 'ziplock' bag. 4) Storage of any and all blister agents should be in airtight cabinets, drawers, or the like, and said storage spaces should be equipped with chemical agent detection monitors to alert of any potential leakage. Use caution when handling thionyl chloride, which reacts violently with water yielding corrosive and toxic fumes. Use extreme caution when handling HN4 hydrochloride. Note: Sulfur dioxide gas and hydrogen chloride gas is evolved during the reaction; use proper ventilation when carrying out the reaction.

## Chapter 8: Preparation of Blister Agents

**Procedure:** Into a suitable flask equipped with mechanical stirrer, place 70 grams of anhydrous tributanolamine, and then add 500 milliliters of dry chloroform. Thereafter, add and dissolve 107 grams of thionyl chloride, into 200 milliliters of dry chloroform. Then, slowly add drop wise, the thionyl chloride/chloroform mixture to the tributanolamine mixture over a period sufficient as to keep the reaction mixture at room temperature. During the addition, rapidly stir the reaction mixture. After the addition, gently reflux the reaction mixture at 60 to 70 Celsius while stirring for about 2 hours. After refluxing for 2 hours, remove the heat source, and allow the reaction mixture to cool to room temperature. Then pour the entire reaction mixture into a rotary evaporator or vacuum distillation apparatus, and remove the chloroform and any excess thionyl chloride under vacuum. After the chloroform has been removed, and dry solid remains, remove the dry solid (which will be HN4 hydrochloride), and then dissolve into 500 milliliters of acetone. Then recrystallize this HN4 hydrochloride solid from the acetone solution. After the recrystallization process, vacuum dry or air-dry the crystalline HN4 hydrochloride product. Then prepare a solution by adding and dissolving 20 grams of anhydrous sodium carbonate into 500 milliliters of cold water. Then place this sodium carbonate solution into a cold-water bath, and then slowly add in portions, the dry HN4 hydrochloride product over a sufficient time as to keep the sodium carbonate solution below 30 Celsius. During the addition, vigorously stir the sodium carbonate solution. After the addition of the HN4 hydrochloride, continue to stir the mixture for about 30 minutes at a temperature below 25 Celsius, and then remove the HN4 crystals by filtration. Thereafter, wash the crystals with 100 milliliters of ice-cold water, and then vacuum dry or air-dry the crystals. **Note: The HN4 hydrochloride can be used as a chemical warfare agent by itself if desired. It is similar in effect to straight HN4; HN4 hydrochloride may be absorbed by the skin faster than HN4. HN4 hydrochloride can be used as blister agent, as it will produce blisters on the skin within 4 to 32 hours after exposure. To use HN4 hydrochloride, dissolve in water, acetone, or methylene chloride to a concentration of about 1 to 5% by weight, and then use this corresponding solution as is. The solution can be disseminated under the usual techniques, or used in spray bottles as a direct weapon against attackers, or animals. If used as a "mace" type weapon, HN4 hydrochloride will cause severe eye irritation, and blindness to anyone exposed.**

### **Procedure 3-011B: Preparation of HN4 (sulfur/chlorine process)**

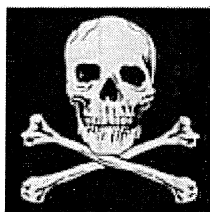
**Summary:** HN4 can be prepared using a modified process, whereby sulfur and chlorine are the agents responsible for chlorination. Before hand, the tributanolamine is converted to the hydrochloride by the action of hydrochloric acid. The resulting mixture is then recrystallized, and the resulting hydrochloride salt then mixed with sulfur, and then treated with chlorine gas. During the chlorine gas addition, the sulfur is oxidized to sulfur monochloride, which in turn then reacts with the tributanolamine hydrochloride to produce the HN4 hydrochloride. The HN4 hydrochloride is then converted to the free base, HN4, by the addition of sodium carbonate.



*Reaction Equation (by products omitted)*

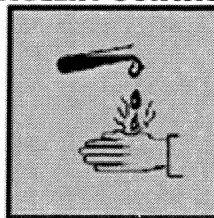
<b>Materials:</b>	1. 62 grams of tributanolamine	5. 43 grams of powdered sulfur
	2. 28 grams of 35 to 38% hydrochloric acid	6. 47 grams of dry chlorine gas
	3. 250 milliliters of dry chloroform	7. 15 grams of anhydrous sodium carbonate
	4. 500 milliliters of acetone	

**Hazards:**



**WARNING!**

**VIOLENT CONTACT**



**HAZARD**

Do not attempt in anyway to prepare HN4 using the following procedure unless proper safety precautions are taken. 1) Perform all operations in a clean box, in which is completely sealed from the air. Note: A clean box in this case is not needed. HN4 can be safely prepared as long as the maker wears proper gas mask, and nitrile gloves. 2) After each procedure, all glassware and non-electric equipment should be soaked in a hot concentrated sodium hydroxide solution before removing from the clean box, and/or before rinsing and storing. Any electrical equipment that may be contaminated (even if suspected), such as hot plates and stirring equipment should be carefully wiped down with a rag soaked in hot sodium hydroxide solution, followed by wiping down with hot water. 3) The desired HN4 product should be stored in amber bottles, preferably non-breakable containers, and stored in a cool dry place away from sunlight. The bottles should also be placed inside an airtight sealed plastic bag, such as a 'ziplock' bag. 4) Storage of any and all blister agents should be in airtight cabinets, drawers, or the like, and said storage spaces should be

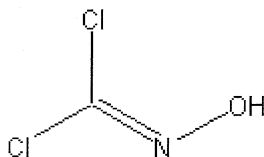


equipped with chemical agent detection monitors to alert of any potential leakage.

Use caution when using chlorine gas, which is toxic and corrosive. Use extreme caution when handling HN4 hydrochloride. Note: Sulfur dioxide gas and hydrogen chloride gas is evolved during the reaction; use proper ventilation when carrying out the reaction.

**Procedure:** Into a suitable beaker, add 62 grams of tributanolamine, and then add 200 milliliters of water. Thereafter, carefully pour in 28 grams of a 35 to 38% hydrochloric acid solution, while stirring the tributanolamine. During the addition, keep the temperature of reaction mixture below 30 Celsius. After the addition, recrystallize the tributanolamine hydrochloride from the reaction mixture. After the recrystallization process, vacuum dry or air-dry the filtered-off crystals. Then place these crystals into a suitable flask, and then add 250 milliliters of chloroform. Thereafter add in 43 grams of powdered sulfur, and then assemble the apparatus similar to figure 045 (see HN3). Then rapidly bubble into the reaction mixture, 47 grams of dry chlorine gas while vigorously stirring the reaction mixture. Note: The chlorine addition should take no longer than 6 hours. During the chlorine addition, the reaction mixture temperature may rise to 30 or 40 Celsius. If the temperature of the reaction mixture rises above 50 Celsius, add a cold-water bath to keep the temperature of the reaction mixture below 40 Celsius. After the addition of the chlorine, continue to stir the reaction mixture for 30 minutes, and then reflux the reaction mixture at 60 to 70 Celsius for 1 hour while stirring the reaction mixture. Thereafter, pour the entire reaction mixture into a rotary evaporator, or vacuum distillation apparatus, and remove the chloroform, and liquid impurities via a vacuum until dry solid remains. Once the chloroform has been removed, and dry solid remains, remove the dry solid from the rotary evaporator, or vacuum distillation apparatus, and then recrystallize the crystals from 500 milliliters of acetone. Note: The dry solid will be HN4 hydrochloride. After the recrystallization process, vacuum dry or air-dry the HN4 hydrochloride crystals, and then place them aside for just a moment. During which time, prepare a solution by adding and dissolving 15 grams of anhydrous sodium carbonate into 400 milliliters of cold water, and then place this solution into a cold-water bath. Then gradually add the crystalline HN4 hydrochloride to the sodium carbonate solution while vigorously stirring the sodium carbonate solution. During the addition, HN4 will separate as colorless to brownish crystals. After the addition of the HN4 hydrochloride, continue to stir the sodium carbonate mixture for 30 minutes at room temperature, and then filter-off the HN4 crystals, then wash with 100 milliliters of ice cold water, and then vacuum dry or air dry the crystals. **Note: The HN4 hydrochloride can be used as a chemical warfare agent by itself if desired. It is similar in effect to straight HN4; HN4 hydrochloride may be absorbed into the skin faster. HN4 hydrochloride can be used as a blister agent, as it will produce blisters on the skin within 4 to 32 hours after exposure. To use HN4 hydrochloride, dissolve in water, acetone, or methylene chloride to a concentration of about 1 to 5% by weight, and then use this corresponding solution as is. The solution can be disseminated under the usual techniques, or used in spray bottles as a direct weapon against attackers, or animals. If used as a "mace" type weapon, HN4 hydrochloride will cause severe eye irritation, and blindness to anyone exposed.**

### 03-012. CX. Phosgene oxime; *Dichloroformoxime*; *Hornet gas*; *Nettle gas*



Phosgene oxime

Phosgene oxime forms a colorless to light colored solid, or colorless to yellowish brown liquid. The pure white crystals tend to slowly turn pink on long standing, and the impure crystals tend to form a light yellowish slurry on long standing. Military grade phosgene oxime will most likely be a yellowish brown liquid, which will be very viscous, and slurry like. Phosgene oxime has a melting point of 35 Celsius, and a boiling point of 129 Celsius (with decomposition starting at 120+ Celsius). It can be easily distilled at 53 Celsius under a vacuum of 28 millimeters of mercury. Phosgene oxime is readily soluble in water, and it is soluble in most common organic solvents. It has a strong and violent sharp odor, with a prickling effect. Phosgene oxime is rather volatile, and it readily evaporates on standing in the open. Its persistence in the environment is satisfactory for military interests, and it can last up to 2 to 3 weeks under affluent conditions; warm and dry with no wind. In some cases its persistence may range from about 24 hours to 7 days. Reports have indicated a rather uneven rate of persistence, meaning it tends to persist longer in some areas than others, regardless of similarities in environmental conditions. One report indicates its persistence in warm and dry climates to be as high 4 weeks. Phosgene oxime is quite stable, and it only slowly decomposes on standing. Decontamination of phosgene oxime can be difficult, and neither bleach nor alkalies show any remarkable rates of decontamination. Phosgene oxime is a violent irritant, which produces immediate pain and stinging upon skin contact. The pain associated with skin contact to the vapor, liquid, or solid resemble that of bee stings. Phosgene oxime violently irritates the eyes, nose, and throat immediately upon exposure. Severe irritation, rash formation, and wheals result within minutes of skin contact. Phosgene oxime is by far one of the most violent irritating substances known to man. Its use in chemical warfare is extremely beneficial on many levels. It can be used for incapacitating exposed personnel, or used in combination with lethal agents such as nerve agents or blood agents where it is desired to get personnel to remove their gas masks. Personnel

### Chapter 8: Preparation of Blister Agents

exposed to this agent either through inhalation, eye or nose contact, or skin contact will suffer from pain and irritation resembling stinging nettle or bee stings. In some cases the exposed personnel will be totally unable to wear their gas masks due to severe irritation, which not only produces physical pain, but emotional drain as well. Exposed personnel will be overwhelmed with thoughts and feelings to seek medical treatment to subside the irritation, that they will remove their gas masks and will not think about their exposure to the lethal nerve gas or blood agents which may also be present. Phosgene oxime is poisonous, and skin absorption or inhalation of the agent can produce systematic poisoning within hours of exposure leading to death. Blister formation usually takes up to 4 to 32 hours after skin contact, but some cases will show no blisters at all. Phosgene oxime is not only a violent vesicant, but it demonstrates activity resembling those of the blood agents. Skin exposure to very small amounts will produce immediate irritation and stinging, with red spots or nodules forming within hours to days. In some cases, persons exposed to very small amounts of vapor develop soars or bumps 12 days after exposure, with the usual pain and irritation upon immediate contact. Skin exposure to large concentrations of vapor, liquid, or solid will produce violent pain, with skin damage resulting almost immediately, or up to several hours after exposure. Inhalation of phosgene oxime can lead to death within hours of exposure, with severe lung irritation and tissue damage resulting before hand. Note: Phosgene oxime is capable of penetrating rubber, rendering some gas masks ineffective. Some plastics and other polymers can be penetrated by this agent as well. Note: According to certain tests, phosgene oxime was able to successfully dissolve certain types of rubber used in the manufacturing of military gas masks. Large concentrations of phosgene oxime can cause some gas masks to "smoke", meaning the polymers in the gas mask decompose with the evolution of heat in contact with phosgene oxime. **Note: The US militaries standard gas masks do not provide adequate protection to field concentrations, and protection against low concentrations is unknown. Phosgene oxime is a fast-acting casualty producing agent capable of disabling and producing casualties within seconds of dissemination. Concentrations of as little as 1 milligram can cause irritation and stinging to exposed skin. Inhalation of as little as 15 to 50 milligrams may produce irritation, and 100 to 500 milligrams thorough inhalation is capable of producing incapacitating results. The lethal dosage through inhalation is rather high, ranging from 2000 to 4000 milligrams. Systematic poisoning from skin absorption ranges from 200 to 1200 milligrams. Skin exposure to 50 to 1500 milligrams of phosgene oxime can lead to the development of blisters within 48 hours.**

<b>OVERALL RATING (scale from 1 to 10)</b>	
<i>Effectiveness (as blister agent): 6</i>	<i>Field Stability: 8</i>
<i>Persistence (open area): 8</i>	<i>Storage stability: 6</i>
<i>Persistence (enclosed area): 9</i>	<i>Toxicity (as blister agent): 7</i>
<b>TOTAL EFFECTIVENESS (as blister agent): 7.3</b>	
<b>OVERALL TOXICITY (as warfare agent): 3</b>	

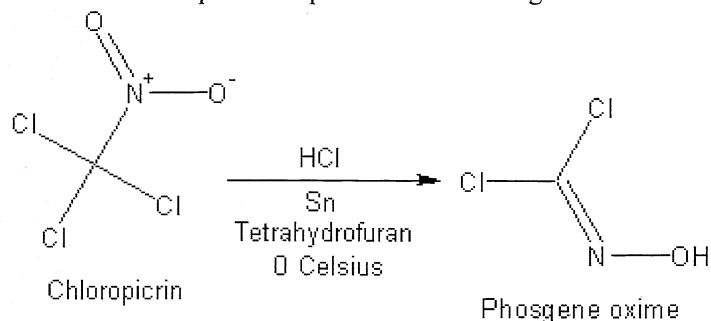
\*\*\*\*\*

<b>OVERALL RATING (scale from 1 to 10)</b>	
<i>Effectiveness (as irritant/disabling agent): 10</i>	<i>Field Stability: 8</i>
<i>Persistence (open area): 8</i>	<i>Storage stability: 6</i>
<i>Persistence (enclosed area): 9</i>	<i>Toxicity (as irritant/disabling agent): 10</i>
<b>TOTAL EFFECTIVENESS (as irritant/disabling agent): 8.5+</b>	
<b>OVERALL TOXICITY (as warfare agent): 3</b>	

### Procedure 3-012A: Preparation of Phosgene oxime

**Summary:** Phosgene oxime is easily prepared, but in a rather expensive process where by chloropicrin is reduced to the phosgene oxime by the reducing action of hydrochloric acid and tin. The reaction is carried out in a solvent of tetrahydrofuran, and at a temperature of 0 Celsius. The total reaction takes about 6 hours, where after the reaction mixture is filtered to remove insoluble tin salts. The resulting filtered reaction mixture is then evaporated, to remove the tetrahydrofuran solvent, and then the remaining residue is placed into a vacuum distillation apparatus, and vacuum distilled twice to obtain a purified product of about 85% purity. The resulting product may be recrystallized from any desired solvent to obtain crystals of 95% purity. Note: The preparation of phosgene oxime discussed in this procedure is similar or related to the process discussed in application number 603,847 April 25<sup>th</sup>, 1984 by William R. Hydro of Bel Air MD. This process may be protected by industrial/commercial process applications. Consult said application number before using the mentioned process for commercial or industrial purposes.

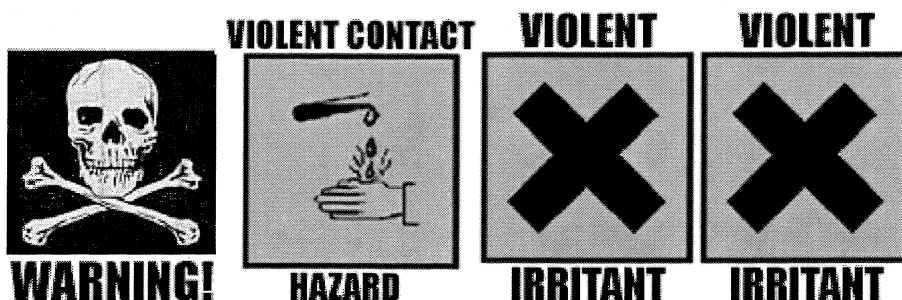
Chapter 8: Preparation of Blister Agents



*Reaction Equation (by products omitted)*

<b>Materials:</b>	1. 800 milliliters of anhydrous tetrahydrofuran	3. 63 milliliters of chloropicrin
	2. 306.6 grams of anhydrous hydrogen chloride	4. 90.2 grams of tin powder

**Hazards:**



Do not attempt in anyway to prepare phosgene oxime using the following procedure unless proper safety precautions are taken. 1) Perform all operations in a clean box, in which is completely sealed from the air. Note: A clean box in this case is not needed. Phosgene oxime can be safely prepared as long as the maker wears proper gas mask, and full body chemical suit. 2) After each procedure, all glassware and non-electric equipment should be soaked in a hot concentrated solution prepared by adding 1 part sodium hydroxide and 1 part of isopropyl alcohol to 10 parts of ordinary bleach (5% sodium hypochlorite solution), before removing from the clean box, and/or before rinsing and storing. Any electrical equipment that may be contaminated (even if suspected), such as hot plates and stirring equipment should be carefully wiped down with a rag soaked in the same aforementioned hot sodium hydroxide/alcohol/bleach solution, followed by wiping down with hot water. 3) The desired phosgene oxime product should be stored in amber bottles, preferably non-breakable containers, and stored in a refrigerator away from sunlight. The bottles should also be placed inside an airtight sealed plastic bag, such as a 'ziplock' bag. 4) Storage of this agent should in refrigerators, and said storage spaces should be equipped with chemical agent detection monitors to alert of any potential leakage.

Use care when handling anhydrous hydrogen chloride, which is very toxic and corrosive. Extinguish all flames before using tetrahydrofuran, which is highly flammable and explosive, and be sure to perform the peroxide test before using tetrahydrofuran that has been in storage for sometime. Use extreme caution when handling chloropicrin, which is highly irritating to the eyes, nose, and throat. Tin powder is combustible, and produces much heat when ignited, avoid contact with fire.

**Procedure:** Into a suitable flask, add 800 milliliters of anhydrous tetrahydrofuran, and then place the flask into an ice bath, and chill to 0 Celsius. Thereafter, bubble into the tetrahydrofuran, 306.6 grams of anhydrous hydrogen chloride gas. After the hydrogen chloride gas has been added, carefully add in 63 milliliters of chloropicrin while stirring the reaction mixture and maintaining its temperature at 0 Celsius at all times. The addition of the chloropicrin should not take to long, and the rate of addition should be careful enough so as not to exceed a temperature of 0 celsius. Once the chloropicrin has been added, slowly add in small portions over a period of 4 hours, while stirring the reaction mixture and maintaining its temperature at 0 Celsius, 90.2 grams of tin powder. Note: When the tin is first added, the reaction mixtures color will change from colorless to a brilliant blue After the addition of the tin powder, stir the reaction mixture for 2 additional hours at 0 Celsius. After 2 hours, filter the reaction mixture to remove insoluble impurities, and then place the filtered reaction mixture into a rotary evaporator, and evaporate-off the tetrahydrofuran under vacuum. After the tetrahydrofuran has been removed, place the remaining residue into a clean vacuum distillation apparatus, and vacuum distill the phosgene oxime at 55 Celsius under a vacuum of 28 millimeters of mercury. Note: In some cases, the phosgene oxime will condense on the walls of the condenser, forming a pasty layer. If this happens, the condenser should be removed after the operation, and then gently heated to melt the phosgene oxime, which can then be collected into a flask. Note: The resulting phosgene oxime

#### Chapter 8: Preparation of Blister Agents

should be vacuum distilled once more at 55 Celsius under a vacuum of 28 millimeters of mercury to obtain a purified product of about 85% purity. The result will be about 26 grams of desired product. This product can then be recrystallized from any desired solvent to obtain crystals of about 95% purity, but this operation is not needed when using phosgene oxime in military operations.

# Section V

## NERVE AGENTS (POTENT ACETYLCHOLINESTERASE INHIBITORS)

### Chapter 9: Physical Nature of Nerve agents

#### Introduction

Nerve agents are a class of compounds called organophosphates. Some of these organophosphates contain fluorine, and some contain sulfur. In essence, nerve agents are highly toxic organic phosphorus compounds that belong to a much larger family of organic phosphorus pesticides such as parathion and malathion. Note: A new class of nerve agents known as complex Quaternary ammonium compounds are now known, and under investigation. Some of these quaternary ammonium compounds may be more potent than many of the conventional nerve agents; see Section 5: Experimental chemical warfare agents.

Nerve agents were in fact developed by the Germans in the 1940's, but evidence has shown research into organophosphate compounds similar to nerve agents began as early as the 1850's; mainly by German, French, and Russian scientists. After the fall of the German empire in the 1940's, the US and Soviet Union heavily stockpiled nerve agents, and conducted much research into them; mainly on Sarin and VX agents.

Nerve agents have been used in some wars before or since the period after their research advancement starting in the 1940's. Several of these wars include the Japanese attacks on China, and Manchuria, America's involvement in Vietnam, and more recently during the Iran/Iraq war. Other cases where nerve agents were used in war probably exist, but exact details are scarce. America used nerve agents in Vietnam primarily during covert operations conducted by the CIA. Some of these operations took place in Cambodia and Laos, and under the tutelage of the "Air America" propagandist campaign. It is unknown if, and how many people were effected by these attacks, but recent reports coming from Vietnam, Cambodia, and Laos indicate enough casualties to warrant investigation. Obviously, The US government fully denies any action, and refuses to investigate the matter. Some people in Vietnam, Cambodia, and Laos to this day, including mainly older persons, and decedents of people affected all show physical or mental signs of exposure to nerve agents; the latter being genetically passed over. Most of these surviving people show similar symptoms to those Americans who returned from Desert Storm.

Much research has been conducted into the physical effects of nerve agent exposure under low concentrations, i.e., chronic exposure. Since the Gulf War, much concern and debate has arisen since thousands of US veterans returning from Desert Storm started to develop unusual and unexplained illnesses. Much of these illnesses are still under heavy investigation and scientific explanations have still not concluded exact physical reasons for their existence; although many theories exist.

#### History

The first actual nerve agent developed, was created by Dr. Gerhard Schrader, who was a chemist and famous German scientist. His research into nerve agents actually started as an effort to synthesize more effective, and elaborate pesticides and insecticides. In 1937 he synthesized a nerve agent called tabun, and he personally experienced its toxicity in the lab after a small drop of it spilled onto a laboratory benchtop. Within moments he complained of dim vision, headache, and difficulty in breathing. Shortly thereafter, he and other colleagues began conducting animal testing on said agent, and found it to be highly lethal, especially through inhalation. Shortly after these experiments, the information was reported to the German ministry of war, and thereafter development into other agents with similar activity began. Shortly thereafter, sarin was developed, followed by soman several years following. The US military adopted the letter designation "G" after Nazi chemical warfare munitions bearing this letter insignia were discovered after the war: GA for tabun, GB for sarin, and GD for soman. Although the Germans had developed nerve agents long before the US or Russia, they never used them during the war; this information has been confirmed, and historians have pondered on the reasons why the Germans never used the lethal agents during the course of World War II. Some historians have stated that the Germans could have halted US and Russian troop advancements to the brink of extinction if they were to have used such lethal agents on a large scale; which they were capable of doing. Some historians have noted that the Germans probably hesitated to use nerve agents during World War II, because they were afraid of US, British, and Russian retaliation, although these nations would have been unable to significantly retaliate in case of massive chemical disseminations by the Germans. During World War II, the only "nerve" like agents the US and Russia were aware of, were incapacitating organic phosphorus compounds such as diisopropyl fluorophosphate, which is much less toxic than tabun, sarin, or soman. The Germans were able to mass-produce tabun, sarin, and soman by 1945, but the fall of Germany

## Chapter 9: Physical Nature of Nerve agents

shortly thereafter gave the technology to the US and Russia. The US and Russia began mass production of tabun, sarin, and soman by the early 1950's.

During the German production of nerve agents during the war, and later on during US and Russian production, hundreds of workers were injured by exposure. Many of these cases went unreported. Some of the cases were documented, but with little being learned or gained through documentation. It wasn't until about the mid 1950's that occupational health and safety rules were created to catalog workers exposed. Shortly thereafter, research into detection, decontamination, and treatment began. In the 1960's research into nerve agent antidotes began, leading to the creation of few by the late 1960's. After the fall of the Soviet Union, many Russian and US chemical weapons research programs were dissolved, and existing research programs began to focus on general chronic exposure, rather than battlefield exposure.

Research into organic phosphorus compounds has continued under a very small pace since the 1950's, with about 99% of the total research being directed towards the agricultural industry rather than military. Most pesticides and insecticides to date are organic phosphorus compounds related to parathion, and malathion; the latter are related to the military nerve agents. The toxicity of most of these pesticides and insecticides is far less than any military nerve agent, but many of them are toxic, and produce similar symptoms. It was determined quite early in the development of nerve agents, that they demonstrate huge physiological activity in the body; primarily acting as acetylcholinesterase inhibitors disrupting neurological activity in the body. Nerve agents also impede on other active enzymes in the body producing a variety of physiological effects, many of which lead to death.

### Militarization

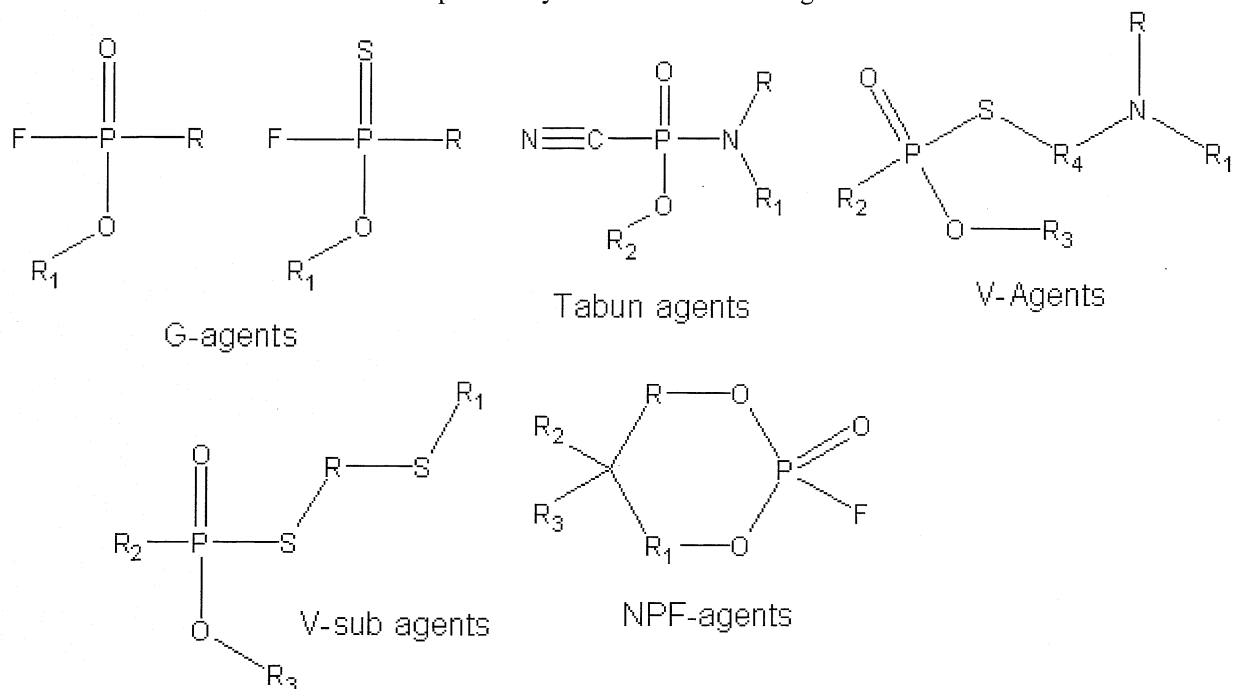
The nerve agents are much more toxic than chemical agents such as chlorine, mustard gas, and phosgene. The latter two saw extensive action in World War I. Most of the previously used warfare agents including mustard gas, and phosgene, were easy to detect in field concentrations. Nerve agents on the other hand, show remarkable persistence, difficulty in detection, and are up to 80 times more potent and toxic than the aforementioned warfare agents used during World War I. Nerve agents can contaminate areas of the environment for months at a time, leaving soil, and surrounding media contaminated with incapacitating doses.

Nerve agents are deliverable by artillery shell, bombs, rockets, grenades, atomizers, humidifiers, foggers, and many types of spray systems. The agents can be sufficiently disseminated using explosives munitions with little loss of the agent due to the destructive forces of the exploding shell; although too much explosive can damage the agents (see Section 6: methods of dissemination and use). For large-scale operations, aerosols, atomizers, humidifiers, or foggers are best used for dissemination. In most spray systems, the agent is merely compressed into canisters with air, and then sprayed over wide areas. In aerosols, the agent is mixed with an inert liquid hydrocarbon, and then placed into sealed containers (like a can of hair spray), and then pressure released upon impact of the projectile, or upon ignition or activation of the munition. Other methods of dissemination, although much less common, include covert and tactical devices usually involving hand-held weapons for agent dissemination. These devices are used with intent to contaminate roads, paths, camps, food products, or drinking water supplies.

In the 1970's the US and Russia developed what are called "binary" chemical munitions, as a result of aging, leaking, and defective weapons caches. Binary weapons are specially designed weapons where two or more separate ingredients are contained. These ingredients are relatively non-toxic by themselves, but form the desired lethal agents upon mixing. The mixing process usually takes place after the weapon has been fired; although, various drawbacks were encountered in this field. One serious drawback was the poor mixing rate of the non-toxic ingredients to form the lethal agent within fast moving or high velocity projectiles. Long-range missiles, and artillery shells could effectively be used for binary munitions, but gun shells, mortars, rockets, and grenades provide insufficient time for the non-toxic ingredients to properly mix. Other drawbacks included improper reaction conditions, unwanted side reactions, and premature decomposition of the impure agents upon impact of the missile or artillery shell. The US and Russia both unsuccessfully tried using binary systems with aerosols, and spray systems to disseminate agents, but encountered the usual drawbacks: improper mixing of non-toxic ingredients, side reactions, unwanted reactions due to pressure or no reactions at all due to very cold liquid hydrocarbon temperatures, and unsatisfactory environmental contamination due to impure agents (hydrogen chloride gas is a major product and contaminant in most of these reactions, and impedes on the success of the agent).

### Chemical nature

Nerve agents all have a particular chemical backbone, which defines them as nerve agents, and gives them their toxicity. The key characteristics are the central phosphorus atoms. This phosphorus atom is always of +5 oxidation state, and is double bonded to either an oxygen atom or sulfur atom. For the tabun agents, V-agents, and V-sub agents, only oxygen is bonded to the phosphorus. For NPF agents, three oxygen atoms are bonded to the central phosphorus atom, with one oxygen being double bonded. This oxygen can be replaced by sulfur, but normally includes oxygen only.



For the G-agents, the fluorine atoms can be replaced by chlorine, bromine, or iodine, but are usually fluorine atoms. For both the G-agents, the R group is primarily methyl, but can be ethyl, isopropyl, or butyl. The R<sub>1</sub> group can be ethyl, isopropyl, butyl, tert-butyl, neopentyl, cyclo, or aryl. The tabun agents contain a CN or nitrile group and a tertiary amine group. The R or R<sub>1</sub> groups of the amine can be methyl, ethyl, isopropyl, butyl, cyclo, or aryl. The R<sub>2</sub> group of the tabun agents can be methyl, ethyl, isopropyl, or butyl, but are usually methyl or ethyl groups. The V-agents all have a central sulfur atom within the arterial vane of the structure with a tertiary amine group at the end. The R and R<sub>1</sub> groups of this amine group can be the usual, but include tert-butyl, neopentyl, cyclo, or aryl. The R and R<sub>1</sub> groups of the V-agents are usually methyl, ethyl, or isopropyl groups. The R<sub>2</sub> and R<sub>3</sub> groups of the v-agents are usually methyl, ethyl, isopropyl, but can be tert-butyl, neopentyl, cyclo, or aryl. The R<sub>4</sub> group is normally methyl, or ethyl, but can be propyl, butyl, or pentyl. The V-sub agents include two sulfur atoms on the arterial vane of the structure, and the R<sub>1</sub> group can be the usual groups. The R group within the arterial vane is usually methyl or ethyl, but can be propyl, butyl, or pentyl. The R<sub>2</sub>, and R<sub>3</sub> groups can be methyl, ethyl, isopropyl, or cyclo. NPF-agents are cyclic phosphorus compounds containing three oxygen atoms. The double bonded oxygen can be replaced by sulfur, but normally includes oxygen. The R and R<sub>1</sub> groups are normal methyl, but can be ethyl, or propyl. The R<sub>2</sub> and R<sub>3</sub> groups can be methyl, ethyl, isopropyl, tert-butyl, neopentyl, cyclo, or aryl. The fluorine atom can be replaced by chlorine, bromine, or iodine, but normally includes fluorine only.

A major characteristic of the nerve agents is the carbon-to-phosphorus bond (represented by the R group for the G-agents, and the R<sub>2</sub> group for the V-agents). This carbon-to-phosphorus bond is not commonly found in non-lethal organic phosphorus pesticides or insecticides.

## Environmental persistence

Nerve agents are highly persistent in the environment, and they can persist for periods as long as 3 months. Some nerve agents are more persistence than others, and each nerve agent's persistence is determined by their physical characteristics. In any case, the nerve agents are more persistent than the blood agents, or riot control agents. Most nerve agents are insoluble in water, and only slowly hydrolyzed by it. Although most nerve agents are insoluble in water, they are soluble in water in very low concentrations, and these low concentrations are considered harmful to humans. Wet and moist environments contaminated with nerve agents can contain very dilute, yet harmful water solutions of nerve agents that may contaminate human bodies upon various methods of exposure. Nerve agents can linger on vegetation for prolonged periods of time, and some nerve agents may actually be absorbed by some plants. Nerve agents in the form of vapor in the air can condense on the surface of leaves, twigs, branches, metal surfaces, wood surfaces, plastic surfaces, and glass surfaces forming tiny droplets. These droplets may fall to the ground, or may dissolve into water forming dilute, yet harmful solutions. In some cases, these tiny droplets of agents can re-volatize forming vapor in the air. The process of volatilization, condensation, and re-volatilization can reoccur many times, even in a single day. In this regard, areas on the ground may contain droplets of nerve agent one moment, and then very few drops the next, but with heavy vapor concentrations of the agent in the same area; this can severely hamper decontamination efforts.

VX is by the far the most effective nerve agent, and the most persistent. It is very non-volatile, and can form condensates on any known surfaces, which can linger for months. Agents like Sarin are rather volatile, and tend to form vapors in the air, which may only condense into droplets during the night. Upon sunrise, these condensations will re-volatize into vapor. Volatile nerve agents can

contaminate larger areas than non-volatile agents as VX. A slight breeze can dissipate the volatile agents over very wide areas. These wide areas may not contain lethal amounts, but can still give rise to chronic exposure. Agents like VX are usually non-volatile to be swept away by a breeze. As a result of VX's non-volatility, it is used to contaminate designated areas for long lasting periods. Strong winds although, may effectively volatilize the VX, carrying it over wide areas.

### **Toxicity: Mechanisms of action**

ACh (Acetyl choline) serves as a neurological transmitter at the end of nerve fibers. Normally, when a nerve impulse arrives, ACh is liberated in packets, which stimulates specialized choline receptors depolarizing the postsynaptic membrane. The ACh is then immediately inactivated and destroyed by the enzyme AChE (acetyl cholinesterase) yielding choline, and acetic acid as products. As a result of this simple, yet complex action, transmission of the impulse ceases, and the membrane repolarizes, and is then ready for another transmission. The process of ACh formation, followed by interaction with AChE is what carries out the nerve transmissions, which allows our brain to communicate with the rest of our body.

When a nerve agent enters the aforementioned process, the situation changes. After ACh is formed during normal neurological transmission, it begins to accumulate around the membrane. The ACh accumulates due to inactivation of the AChE, which is caused by reaction with the nerve agent. Nerve agents bind to the AChE enzyme, inactivating it. When the ACh accumulates, it gives rise to un-ordered, and uneven bursts of neurological transmissions, which go unchecked due to AChE inactivation. Within moments, the membrane site undergoes paralysis. Paralysis of the effected membrane then brings about physical bodily disfunctions, starting with the usual nerve agent symptoms, and then resulting in death, or long term illness. Exposure to nerve agents causes paralysis to multiple membrane sites, but due to the extreme efficiency at which the nerve agents bind with AChE, and the resulting accumulation of the ACh, very little nerve agent is needed to cause severe illness; hence the high toxicity of nerve agents.

### **Symptoms from exposure**

- 1) **Muscarinic miosis** (Lachrymation effects): Increased nasal secretions, but unlike exposure to riot control agents. Nasal secretions primarily include runny nose, without nasal congestion or soar throat. The runny nose will be rather persistent, and can last for hours; chronic exposure to nerve agents can lead to persistent runny nose. Other effects include tightness in chest, and difficulty in breathing; cramps, and gastrointestinal disorders; nausea and vomiting; diarrhea, profuse sweating; frequent urination, and heart blockage resulting in death.
- 2) **Nicotinic** (Muscular disorders): These symptoms include muscle weakness, tremors, muscle cramps and uncontrolled or sporadic muscle twitching, elevated blood pressure, and tachycardia.
- 3) **Central Nervous System**: These symptoms are the normal illnesses as a result of exposure. The symptoms are short lived under lethal concentrations, but can be long term (lasting for years) under low and chronic exposure. Symptoms include headache, dizziness, weakness, impaired memory and alertness, anxiety, tension, emotional distress, seizures, insomnia, excessive dreaming, coma, respiratory depression, paralysis, and death.

The above symptoms are the predominate illnesses cause by nerve agent exposure, but research has indicted other symptoms may exist. Receptors activated by not only ACh may also lead to the release of other neurotransmitters within the brain, leading to the release of other accumulative compounds as well as ACh. These "other" accumulative compounds alone, or along with ACh may create other mechanisms within the system leading to other disorders related to, or unrelated to the buildup of ACh alone. Some of these other illnesses may be strictly the result of chronic exposure, and their exact origin and scientific roots is unknown in many regards.

### **Treatment**

Atropine is the prime compound for the treatment of nerve agent poisoning. Atropine affects the ACh on muscarinic receptors, but it does not act upon nicotinic receptors. Oximes, are another common treatment drug, and are used to reactivate AChE by displacing the agent from the enzyme, but it only works within a short time after exposure to a nerve agent; it must be administered immediately after contamination or else it does not work. The disadvantage of Oximes is they do not affect soman poisoning in anyway. For the treatment of soman nerve gas exposure, a compound called pyridostigmine was found to work on the nicotinic receptors with satisfactory results. Most military forces around the world have injectable forms of atropine, pralidoxime (2-PAM chloride), and diazepam, which all work at slowing or defeating the poisoning effects of nerve agents, but in essence, any nerve agent antidote has to be administered immediately (within 5 to 15 minutes) of exposure. Diazepam is used for its anticonvulsant effects.

It is known that certain nerve agents like cyclosarin are resistant to treatment with oximes such as pralidoxime. Note: Not all AChE inhibition does not explain all aspects of nerve agent poisoning, and the aforementioned treatment drugs may not serve to cure or eliminate all possible symptoms of nerve agent poisoning. Nerve agents can also inhibit other esterases including trypsin, chymotrypsin, and thrombin. In some cases, a compound called phenylmethylsulfonyl fluoride has been known to cure exposure to some nerve agents including VX, soman, and cyclosarin, with excellent results achieved even after sufficient time has passed from exposure. This drug was only tested in experimental animals, and information of its use with exposed humans is speculated.



Phenylmethylsulfonyl fluoride might be used to successfully treat persons suffering from symptoms brought on by chronic exposure, i.e., The Gulf War syndrome.

## Methods of body entry and potential fates of exposure thereto

**Dermal adsorption:** Nerve agents are readily absorbed through the skin, and into the circulatory system, from where they easily spread throughout the body. Nerve agents can also easily penetrate the linings of the lungs, and the lining of the gastrointestinal tract. The lungs absorb nerve agents much faster than the skin. Toxicity of nerve agents through skin absorption is much slower than through inhalation, and tends to require higher concentrations. The more volatile nerve agents such as sarin and tabun tend to volatilize before significant skin absorption can take place, but agents like VX are very non-volatile and rapidly absorbed by the skin. VX is much more effective at producing casualties through skin absorption, or gastrointestinal absorption than other agents. After entering into the circulation of the body through dermal absorption, nerve agents begin to distribute throughout the body. The distribution of the nerve agents by the circulatory system is not the same in every person, and toxicity through absorption may vary from person to person.

**Ocular:** Nerve agents can be readily absorbed through the conjunctival sac of the eye. Theoretically, lethal concentrations can be absorbed as droplets or vapor, but exact levels through eye inhalation are unknown. Absorption through the eye usually gives no warning, but symptoms include dim vision, impaired night vision, headache, lethargy, and impaired vision effects.

**Respiratory:** Obviously, the predominant entry of nerve agents into the body does so through inhalation. Vapors, mists, fog, and aerosols are easily inhaled, and thereby absorbed by the lungs into the blood stream. Reports have indicated that resting troops are more likely to die from lower concentrations of nerve agents through inhalation, than active troops working and moving. These reports indicate potential deactivation of the nerve agents by rapid circulatory activity. The process for deactivation of the nerve agents in this manner is not quite clear, but indicates that higher circulatory action (by active and moving troops) causes more rapid detoxification rates—although, this should not be seen as a potential fix for nerve agent exposure.

**Ingestion:** Ingestion of nerve agents is highly toxic, but not as toxic as inhalation. The lethal doses through ingestion tend to be higher than through inhalation. Reports have indicated that different nerve agents have different lethal doses through ingestion. It is reported that sarin and VX tend to be more toxic through ingestion than soman or cyclosarin. Because of the differences in people's body chemistry, it is hard to predict exact lethal concentrations. Ingestion in any sense of low concentrations tends to produce the usual gastro problems including cramps, colic, nausea, vomiting, and diarrhea. Ingestion of lethal concentrations usually takes anywhere from 20 minutes to 3 hours to kill any exposed personnel. Ingestion of lethal concentrations tends to forgo the aforementioned gastro problems.

## Metabolism

Reports have indicated that certain nerve agents can be detoxified in some people, but this is not to say these same people are immune. In all cases, exposure to lethal doses is fatal, but the reports indicate that some people may be immune to low and/or chronic doses. Some nerve agents like soman tend to accumulate in the body, and are stored by the body for prolonged periods of time without any real illness. Later on, it seems any stored nerve agents are then released, causing systematic poisoning, and death. Tests showed that soman could be stored in fat cells by some people for periods of several months, without any real danger to the person during that time. This demonstrates a possible connection between the strange illnesses overcoming veterans of the Gulf War. It is possible to say that chronic or low exposure to nerve agents can lead to no immediate injury, but gives rise to illness sometime later due to released nerve agent previously stored in the body.

The metabolic action of nerve agents in the body is unknown, and research on nerve agents is rather sluggish these days. Little information is available on metabolic rates of nerve agents, especially as it pertains to storage, and the effects involved. Reports indicate that metabolic action of the body on nerve agents may differ at different times in the day, and under different moods of the soldiers. Soldiers under a lot of stress and physical movement showed an increased metabolic rate, decreasing the toxicity levels of the agents. At the same time, reports showed relaxed, and content soldiers at rest were more likely to be affected by lower doses than those soldiers previously mentioned. Other reports have indicated the toxicity of nerve agents to be more toxic at night, than during the day.

## Behavioral effects of nerve agent exposure

Behavioral effects of personnel exposed to low concentrations of nerve agents may vary, but in general includes fatigue, memory loss, anxiety, and decreased mental performance. Exposure through inhalation is the usual method of entry where by noticeable mental changes can be observed. It was also found that skin absorption tends to produce such behavioral disorders as well. In some documented reports, skin absorption of nerve agents was found to lead to pronounced memory problems, changes in thinking and thought, and various mood swings. Other behavioral symptoms include emotional distress, nervousness, anxiousness, impaired coordination and balance, and a general sense of confusion and irritability. Obviously, exposure to lethal concentrations would forgo most of these symptoms.

## Combined effects of nerve agents with other warfare agents

Nerve agents show increase toxicity when mixed with nitrogen mustards. Tabun for example, shows increased toxicity when mixed with HN3. When nerve agents are mixed with nitrogen mustards, serum cholinesterase levels in the body recover much less slowly than when nerve agents are used by themselves. In essence, this means that the rate in which nerve agents interfere with AChE in the body is increased, making the onset of reaction more rapid; if nerve agents were not already toxic enough, the nitrogen mustards increase this toxicity up to three fold. Mixing nerve agents with nitrogen mustards not only increases toxicity rates, but absorption rates as well. Studies have shown that nerve agents can penetrate the skin and eyes up to four times faster when they are mixed with HN1, HN2, HN3, or HN4. When mixing nitrogen mustards with nerve agents, the nerve agent should be in a ratio of 3 to 1; three parts nerve agent to one part nitrogen mustard.

Little research has been conducted on the effects of nerve agents combined with blood agents. It is safe to assume that many blood agents are soluble in nerve agents, and hence, capable of being combined. Mixing blood agents with nerve agents may increase the toxicity for both, but because nerve agents are highly toxic, along with the blood agents, combining both elements is not necessarily needed.

## Potential pretreatment of personnel

In clinical trials, humans exposed to low concentrations of nerve agents after pretreatment with atropine, pralidoxime, or physostigmine showed fewer symptoms; nevertheless similar trials demonstrated that pretreatment with the aforementioned nerve agent antidotes actually increased the toxic affect of the nerve agent. Pretreatment with physostigmine did not protect subjects from low doses to nerve agents, but actually enhanced the toxicity of these nerve agents.

## Chronic exposure

There is limited information regarding chronic exposure, especially when it comes to military and occupational exposure. Animals and humans exposed to non-lethal amounts of nerve agents on continuous and persistent levels showed signs of tolerance after 1 week; meaning further non-lethal doses had no effect. The effects of exposure before hand gave the usual symptoms through inhalation, ingestion, eye, and skin absorption. In one clinical trial, dogs were fed low doses of sarin once a day for 6 months. These trials resulted in some illness, with the usual symptoms being noted, but also signs of tolerance and immunity in many of the dogs within two weeks of the trial. After the six-month trial, all dogs made full recoveries with no signs of permanent illness. This trial clearly contradicts some trials pertaining to the long-term affect of nerve agent exposure; especially in regards to Gulf war veterans. Other trials regarding soman, tabun, and cyclosarin showed similar results. In all cases, brain levels of AChE stabilized after particular times (ranging from 7 to 21 days) during chronic exposures of animals to the nerve agents.

It is unknown exactly what affects humans would show during chronic exposure. Veterans of the Gulf War have complained of irregular symptoms, none of which have any logical origin, other than possible exposure to nerve agents. In this regards, it is highly likely that personnel suffering from illnesses after the Gulf war, do so because of one single factor: These people were more likely exposed to non-lethal amounts of nerve gas, but only for periods less than would be described as "chronic" exposure. Exposure to non-lethal amounts of nerve agents, but for periods ranging under 7 days would be considered non-chronic exposure, and would most likely produce symptoms and illness.

## Delayed affects

In general, nerve agent exposure is lethal under many concentrations. As previously described, chronic exposure or exposure to non-lethal amounts of nerve gas over varying periods of time can lead to symptoms, and potential permanent illness. However, one aspect that will be briefly discussed here is the potential for delayed affects as a result of nerve gas exposure. In some trials, animals exposed to non-lethal amounts of nerve agent over short periods of time developed almost immediate symptoms, the majority of the time. Although, a few cases showed little or no symptoms up 7 days after exposure. These few cases did however eventually come down with the usual symptoms after periods ranging from 7 to 10 days. This information is of importance in the field of genetics. It is possible that gene sequences within these animals' bodies may have temporarily protected them from immediate symptoms. In a few side tests, these same animals were given the usual nerve agent antidotes within 7 days, and most of them made full recoveries within 2 weeks. Conclusion, in the future, geneticists might be able to code those gene sequences into soldiers bodies, giving them a virtual window of safety during and shortly after exposure to nerve gas. These soldiers could then be treated before the delayed affects arrive. Field tests, and gathered information on personnel exposed to nerve gas as a result of occupational hazards has given no clear evidence of "protective" gene sequences in humans, and many scientists regard delayed affects of nerve gas exposure to be virtually non-existent; although, many of these same scientists regard delayed affects in humans as possible.

Delayed affects in humans may or may not be the result of protective gene sequences, but in any light, delayed affects in humans could arise after 3 to 9 days of exposure to low levels of nerve agent. Although similar in nature, these delayed affects would be somewhat different than the normal symptoms of nerve agent exposure. Examples include, convulsions and dry heaving (rather than nausea), blurred spots in the center of vision, tipsy or drunk-like states, tingling sensations in the fingertips and cheeks, seizures,

cardiac arrests, and muscles spasms. Agents that may show delayed affects are: Sarin, soman, tabun, cyclosarin, and NPF. Agents that are probably unlikely to show delayed affects include: VX, VXII, V-sub x, and thiosarin.

### **Acute effects**

Acute effects refers to effects of exposure from multiple modes of nerve agent entry into the body. In essence, acute exposure refers to nerve agents entering the body through inhalation, along with ingestion and/or skin and/or eye absorption during specific times. The various modes of entry into the body can be simultaneous, or offset, meaning exposure to nerve agents through several modes of body entry simultaneously, or exposure to nerve agents through several modes of body entry with each entry offset from the other. Acute affects to nerve agent exposure are similar, but more severe then for inhalation, ingestion, and eye/skin absorption alone. Obviously, multiple modes of body entry would produce pronounced effects over single modes of body entry. Intoxification to nerve agents is much more rapid and more pinpoint. Chronic exposure or exposure to non-lethal concentrations of nerve agent through acute toxicification under periods of 7 days can result in a plurality of symptoms, which can lead to permanent illness. In some cases, a few people may experience delayed effects. Chronic exposure or exposure to non-lethal concentrations over periods of 7 days can result in the same aforementioned effects, with signs of tolerances forming after 7 days; nevertheless, acute exposure is rarely curable, even with immediate antidote administration.

### **Exposure to high concentrations of nerve agent**

Nerve agent exposure under high concentrations usually leads to death in several minutes. A few documented cases have stated that persons exposed to high concentrations of nerve agent were able to survive due to immediate hospitalization. During treatment, these persons suffered from particular disorders including rapid heart rate, high blood pressure, respiratory distress, cyanosis, and inflamed conjunctivae. In all cases, these persons decontaminated themselves using charcoal or bleach prior to hospitalization, but none administered antidotes to themselves immediately after exposure; all were given atropine and 2-pyridine aldoxime methiodide during hospitalization.

Survivors of high exposure mentioned suffering from bad dreams, psychiatric conditions including depression and withdrawals, restlessness, nausea, and vomiting; symptoms which went away after about 2 days, with full recovery by 6 months. In similar cases, soldiers injured by nerve agents during military training suffered from cyanoses, and seizures. In these cases, recovery was made in about 6 months, with severe symptoms lasting for only about 2 or 3 days after exposure; in all cases, the exposed personnel were treated with atropine and 2-PAM chloride within 5 to 15 minutes of exposure.

In most cases persons exposed to high concentrations of nerve agent can survive with full recoveries being made if treated and hospitalized immediately. Immediate treatment and hospitalization is more common for persons facing occupational hazards, or for military training personnel, but soldiers on the battlefield are less likely to have immediate treatments available except for personnel antidotes; personnel antidotes must be administered within 5 to 15 minutes of nerve gas exposure. Note: Even if antidotes are administered within minutes of exposure, there is no guarantee of recovery. Several documented cases discussed patients dying within hours of exposure to high concentrations, regardless of immediate treatment.

Many documented cases arose after the nerve gas attacks in Japan, but even though there were hundreds of people poisoned by these sarin gas attacks, many of these documentations are inadequate to support conclusions due to several factors: 1) The sarin used in the attacks was heavily contaminated with impurities, and would not be considered satisfactory by trained personnel for military use. 2) Due to the severity of the impure sarin, it's unknown whether these impurities could increase toxicity, or decrease toxicity. 3) The severity of impurities may lead to a multitude of additional symptoms along with the nerve agent symptoms making correct scientific diagnosis almost impossible. 4) The impure sarin was not disseminated properly, meaning that much of the agent remained in liquid form and failed to volatilize. 5) The total amount of sarin released into the air is unknown, but was probably less then that considered "effective" for the operation.

In essence, nerve agents under high concentrations are extremely dangerous, and can cause fatalities within minutes. Even though the aforementioned cases ended in full recoveries of the patients, nerve agents under most conditions are lethal. Documented cases, and scientific studies can vary. As with other scientific studies, some tests may show one set of results, but at the same time, others might show opposite results. It is safe to say that nerve agents are highly toxic in any nature, and exposure to low concentrations or high concentrations leads to a multitude of symptoms, which may differ in certain people. It is probable that a few people might actually be immune to nerve agents based solely on genetics along, but overall, nerve agents are highly toxic.

### **Long term affects after recovery**

In many of the documented cases where exposed persons made full recoveries, there exists much question about the patients' true health. Follow up work on patients' years later, has revealed a complex array of symptoms classified as long term. For many of these recovered patients, there exists illnesses', still being suffered by these survivors' as much as 10 years later. The symptoms usually include chronic fatigue, motor and nerve response problems, chronic dizziness, blurred speech, problems remembering things, and changes in the taste of food. One documented case on a soldier exposed to nerve gas 15 years ago stated that to this day eating certain foods often resulted in unusual and strange flavors upon the taste buds; in other words, common foods displayed different tastes upon

eating. Examples included coffee tasting very sour and unpleasant, bananas tasting of metallic nature, and garlic resulting in a fruity aftertaste. What these symptoms mean, and their direct origin is unknown. Presumably, intoxication by nerve agents can result in chronic damage to the nerve system, which spreads to different areas of the body during the initial point of exposure. This would explain differences in long-term symptoms experienced by different people. Some long-term illnesses experienced by exposed persons forgo some of the aforementioned symptoms, but rather include muscle spasms, chronic runny nose, and tingling in the fingertips.

### **Short term exposure with unknown concentrations (through inhalation)**

Short-term exposure to unknown concentrations is more common than most other types of exposures. Up to now, a variety of illnesses and affects have been discussed under different situations of exposure, but not so much on short-term exposures to unknown concentrations. Many situations and symptoms exist, and exposure to nerve agents in this manner can lead to similar symptoms as with chronic or acute exposures. The following is a military example of short term exposure to military grade nerve gas, and should not be considered a model representing all persons exposed to nerve gas (especially cases involving agricultural workers, or victims of the attacks on Tokyo Japan).

Documented example of soldier exposed to sarin gas after field-testing operation on November 10<sup>th</sup>, 1953 (the concentration of the gas was unknown): The soldier was able to detect sarin in the air, so he tightened his mask. Within minutes, he developed a frontal headache and rhinorrhea. Within 4 hours, he had pinpoint pupils, photophobia, headache, and eye pain. He was fatigued and reported that his joints felt stiff. He was administered oral doses of atropine and continued working the rest of the day. That night, he was restless and could not sleep. His headache continued, and he awoke from several nightmares. After each awakening, he was disoriented and had numb legs. His nausea quickly improved, but his night vision was poor. That morning, he went back to work. The next day on November 12<sup>th</sup>, he had a headache, small pupils, and he had trouble reading and focusing on objects. That night, he awoke every three hours or so. He was administered 400 micrograms of atropine, which he claimed helped with the symptoms. Again, that morning, he returned to work, but his symptoms worsened during the day. His rhinorrhea increased, and he vomited after lunch. Diarrhea developed shortly thereafter, resulting in 12 watery stools. He then developed a chronic cough with thick mucous. That evening, he had vertigo and nearly fell over. He was administered atropine again, but with little help impeding the symptoms. Sleep that night was frequently interrupted, and he felt confused and numb all over. The next day his memory was terrible, not being able to remember things he just said, and his joints were stiff. Later on he developed heartburn and belching. He vomited a few more times, and was suffering from severe depression. The symptoms were on and off for the next couple of days, but after 7 days from the time of exposure, the symptoms began to lessen, and after 14 days were gone. The soldier made a complete recovery within 1 month. Note: This same soldier developed long-term symptoms within 1 year after his exposure. To the day of his death, many years later, he complained of a multitude of illnesses as described under "long term exposure".

### **Short-term exposure to unknown concentrations (through eye and skin contact)**

Short-term exposure through eye and skin contact results in similar illness as through inhalation, but with less severity and duration. It has been found that persons exposed to nerve agents through eye and skin contact showed no symptoms or "long term" illnesses up to 3 years after initial contact; although, these persons did suffer from similar symptoms as other exposure situations. Symptoms included profuse sweating, numbness, achy joints, and emotional distress. In a VX accident, it was reported a female scientist made skin contact with a small drop of the agent on her forearm. The initial skin contact produced no symptoms, but soon thereafter, symptoms did develop. The symptoms included chest pressure (lasting for 3 days), extreme fatigue, profuse sweating (for 36 hours), and severe emotional distress (confusion, stupor, nervousness, depression, and guilt). Skin exposure to other agents probably produces similar affects.

One interesting case documented raised concerns about the toxic nature of some nerve agents through eye and skin contact. In the 1970's, a researcher was accidentally sprayed in the face with an unknown, but most likely small amount of VX. This person was immediately decontaminated, and treated with atropine and 2-PAM chloride. Within minutes of exposure, he experienced the usual symptoms, which lasted for only several days. Thereafter, he recovered, but became ill some months later. Shortly he collapsed under cardiac arrest, but was revived with no permanent illness. Several years after the initial exposure, no symptoms or illness were reported. In light of this documentation, it was apparent that much of the VX was destroyed and/or absorbed upon decontamination thereby sufficient poisoning was avoided. Obviously, the non-volatile nature of VX is what ultimately saved his life; nevertheless, other documented cases involving VX resulted in death and/or permanent injury to those exposed.

### **Intermediate syndromes**

Intermediate syndromes are hard to classify and diagnose. In particular, acute neurotoxic syndrome can follow the initial cholinergic period of nerve agent poisoning. The syndrome includes paralysis of limbs and respiratory muscles. These symptoms may be delayed in some people due to peripheral neuropathy, which seems different from classic delayed polyneuropathy. This intermediate syndrome has only been reported in a few cases, but its existence in more cases is probable. Other intermediate syndromes probably exist, but information on such syndromes is hard to achieve at this time.

## Recovery

In general, recovery from mild exposures to nerve gas is rapid, although in some studies, 20% of exposed personnel had symptoms beyond 2 weeks. 10% had symptoms beyond 3 weeks. In a few cases, persons exposed to mild doses of nerve agents suffered from symptoms for up to 2 years. It is probable that symptoms in this manner can range for more than 2 years. Recovery for personnel exposed to moderate or high concentrations may vary. As previously discussed, symptoms may be different in other people as well as the results. Symptoms in some cases lasted for years, where as other cases symptoms only lasted for several days to several weeks. In other terms, eye and skin exposure can yield different results with symptoms lasting for different periods of time then by contact through inhalation, and each nerve agent is essentially a unique species with its own clinical theories and trials. Recovery in essence, is dependent on methods of body entry, individual persons, and exact quantities of nerve agent encountered. In most regards, only about 60% of exposed cases documented to date have made full and non-restrictive recoveries. This percentage is based on documented cases of exposed personnel to non-lethal amounts of nerve agent. Exposure to lethal concentrations usually results in death, and recovery information need not be discussed.

In summary, the recovery of victims of nerve gas exposure fluctuates. No guarantee can be given to those exposed to nerve gas that they will make full recoveries, and it is likely that most people exposed to them will suffer from symptoms for years to come. In essence, there is no real recovery of persons exposed to nerve gas. In some cases, people have died over a year after being exposed to various levels of nerve gas. Some people make full recoveries, and some people don't. The threat of long-term effects in exposed personnel is like cancer in many regards; some people get it, some people don't. How this translates on a genetic level is still unknown due to a lack of nerve agent and clinical research. It is safe to say that exposure in any sense to nerve agents should be avoided at all costs.

## Summary and conclusion

Nerve agents are highly toxic compounds, which inspire fear and intimidation in the hearts and minds of many. Nerve agents produce lethal results in microgram per kilogram quantities. Their main effects are caused by irreversible inhibition of the crucial enzyme AChE, producing signs and symptoms resulting from excess ACh buildup in the system. This build up of ACh causes over stimulating effects on parts of the nervous system. They also inhibit a variety of other enzymes, but these biological consequences are poorly understood and researched. This same scenario applies to their interactions with neural receptors and cell membranes.

Some nerve agents such as tabun and sarin are very volatile, resulting in significant threat to the respiratory system; via inhalation. The volatility of these nerve agents makes them less of a threat to skin contact, and exposure through ingestion is very rare. Soman thiosarin, NPF, and cyclosarin are less volatile and more persistent. These more persistent agents present a much greater hazard through skin exposure than sarin or tabun. VX, VXII, and V-sub x demonstrate outstanding persistence, and toxicity. These agents can remain in the environment for months at a time, and they possess extreme hazards through skin and eye absorption, and through inhalation.

Intoxications with nerve agents produce a variety of signs of symptoms including seizures, respiratory distress, unconsciousness, and circulatory collapse, which can lead to brain and cardiac injuries that can last for long periods of time. Delayed neuropathy from inhibition of AChE, and excessive ACh buildup is rare, but probable. Sarin and soman have produced delayed neuropathy in laboratory animals, but no reports in humans have been filed at this time. It is unknown whether cyclosarin, thiosarin, NPF, VX, or V-sub x are capable of producing delayed neuropathy, but it is likely.

The eyes are very sensitive to nerve agents, but direct exposure is limited; nevertheless, symptoms of eye exposure are constriction of pupils, pain and difficulty focusing, dim vision, and dilated conjunctival vessels. Respiratory symptoms include headache, confusion, anxiety, dizziness, rapid or abnormal heart rate, constriction, tightness in chest, nausea, vomiting, and runny nose. Ingestion, although rare, includes the following symptoms: cramps, gastrointestinal disorders, gas, nausea, vomiting, internal bleeding, dizziness, dim vision, tingling sensation in finger tips, and difficulty in remembering things. In all of these cases, symptoms from exposure can be from low concentrations to moderate concentrations. Exposure to high concentrations is usually fatal, but similar symptoms may be felt prior to death.

The persistence of nerve agents varies, but most them are considered very persistent. Many nerve agents can remain trapped on or within dust particles, wood particles, soil, vegetation, and skin particles. Dust particles and micro fine particles from plants and even skin can be inhaled leading to potential poisoning. Dust particles are of particular hazard as they can trap a significant amount of agent; dust can be carried over large areas.

Humans retain about 85% of inhaled nerve gas, and some is trapped in the mucous of the respiratory tract. Trapped agents in mucous can remain inactive for periods of several hours to several days; where upon they are absorbed into the body leading to systematic poisoning.

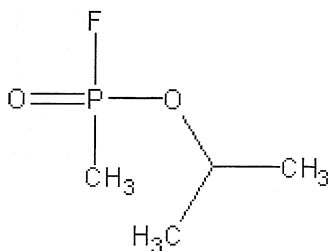
Nerve agents are highly toxic phosphorus compounds capable of killing and/or injury many people. Nerve agents can be used on multiple levels for military operations. They can be used for direct enemy exposure, tactical operations, to produce detours or "road blocks", and/or general casualty production. Nerve agents can be used not only to kill enemy personnel, but also to cause mass casualties and confusion. Casualties caused by nerve agents can render serious problems for medical and rescue personnel, which can seriously disrupt current military offensive or defensive operations. Nerve agents can be used to divert troop movements by specifically contaminating strategic areas. Large areas can be contaminated with specific agents like VX to completely disable, or hamper enemy troop movements; even with masked personnel, movement and function in areas contaminated with VX or other agents

### Chapter 9: Physical Nature of Nerve agents

is extremely difficult, and it is impossible for soldiers to remain completely masked for periods over 3 consecutive days. Note: Think about how difficult it would be to function in a contaminated environment completely masked: unable to feed, unable to urinate or defecate, and the physiologic effects of being trapped or claustrophobic due to chemical suit and mask. Gas masks become very difficult to wear for periods more than 24 hours, as sweat and itching develops on the face followed by irritability. Nerve agents by far are the most effective chemical warfare agents known. They are highly toxic and persistent, and their use has been questioned and debated by many nations. To date, no nerve agents have actually been used in large warfare operations, but it is probable that some day they will. Until that day, only a few documented cases of exposure can be used for clinical and medical studies. Mass dissemination of nerve agents would defiantly cause severe casualties not only to military personnel, but to civilians as well. The long-term effects of such an event can only be speculated, but it would be presumed to have devastating consequences. Regardless of all the politics and meetings, and special debates, it is highly unlikely that nerve agents will ever be banned completely. The potential of nerve agents being manufactured and used by various nations is very high. Most nations probably have stockpiles of chemical warfare agents on hand, regardless of attempts by some nations to curb manufacture and stockpiling. The US and several other western nations try hard to curb manufacture and stockpiling of nerve agents, and the US pays countries willing not to manufacture them. Regardless of these efforts by the US and other nations, production of nerve agents will always be a reality, and the potential for them being used will always be a major concern.

# Chapter 10: Preparation of Nerve Agents

## 04-001. Sarin. GB; Trilon 46; *Isopropylmethylphosphonofluoridate*; *Isopropoxymethylphosphoryl fluoride*;



Sarin

Sarin is a colorless, amber, or brownish to brownish-amber liquid with no odor when pure. Contaminated and/or impure sarin may have a weak fruity odor, similar to a weak ethyl acetate solution. Sarin has a boiling point of 146 Celsius (with decomposition), but can easily be distilled under vacuum; boiling point: 56 Celsius at 16 millimeters of mercury. It is soluble in water in all proportions, and is readily soluble in most common organic solvents, including methylene chloride, ether, acetone, ethanol, dimethyl sulfoxide, dimethyl formamide, and acetonitrile. Sarin is also readily soluble in cooking oil, olive oil, fats, oils, and lipids. Sarin is rapidly hydrolyzed by water, and will be completely decomposed by it within a day. Sarin has a half-life of about 1 hour at 150 Celsius. Droplets of sarin into water will persist for only several hours at room temperature, and straight droplets of the agent on the ground may only persist for several hours due to the volatility; sarin evaporates at the same rate as water, so on warm sunny days, its persistence is very low. Sarin is most effective when used within closed environments, tunnels, rooms, buildings, and bunkers. Solutions of bases, such as sodium hydroxide, sodium carbonate, or potassium hydroxide decompose sarin rapidly, producing relatively non-toxic products. Standard military decontamination kits are more than satisfactory for its decontamination. Bleaching powder, or *Clorox* bleach completely destroys sarin, and should be used in all cases to decontaminate, destroy, or clean any contaminated environments. Sarin can be effectively decontaminated using aerosols, explosives munitions, atomizers or humidifiers, or foggers. **Toxicity: Lethal dose 50% of population i.p. in mice: 0.420 milligrams per kilogram of body weight. The lethal dose for the average man is about 0.010 milligrams per kilogram (800 micrograms lethal dose for a man of 180 pounds of weight). When used properly, 4 milligrams of sarin can kill 5 soldiers. Sarin is a fast acting nerve agent capable of causing casualties within minutes of dissemination. Personnel exposed to non-lethal amounts of the agent may still become incapacitated within 10 minutes of exposure, and will become unable to perform their normal duties as soldiers. Those personnel exposed to lethal doses will be dead within 10 to 60 minutes. Sarin is highly toxic through ingestion, inhalation, skin absorption and eye absorption.**

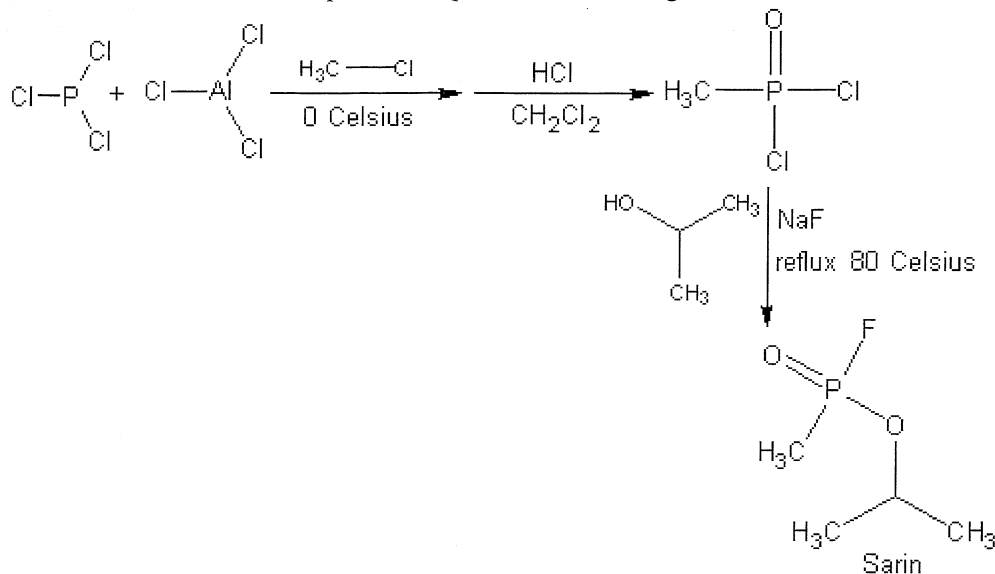
OVERALL RATING (scale from 1 to 10)	
<i>Effectiveness (as nerve agent): 7</i>	<i>Field Stability: 6</i>
<i>Persistence (open area): 6</i>	<i>Storage stability: 8</i>
<i>Persistence (enclosed area): 8</i>	<i>Toxicity (as nerve agent): 7</i>
<b>TOTAL EFFECTIVENESS (as nerve agent): 7</b>	
<b>OVERALL TOXICITY (as warfare agent): 8</b>	

### Procedure 04-001A: Preparation of Sarin (sodium fluoride process)

**Summary:** Sarin is easily prepared using a convenient three-step process, starting with the preparation of methyl phosphonic dichloride. The methyl phosphonic dichloride is easily made by reacting methyl chloride, and phosphorus trichloride in the presence of anhydrous aluminum chloride to form an insoluble complex. This insoluble complex is then recovered by filtration, dissolved in suitable solvent, and then hydrolyzed with concentrated hydrochloric acid. The hydrolyzed product is the methyl phosphonic dichloride. The methyl phosphonic dichloride is then treated with a mixture of sodium fluoride and isopropyl alcohol in toluene. The resulting reaction mixture is then refluxed at moderate temperature, allowed to cool, and then filtered. The filtered reaction mixture is then distilled to yield a crude sarin product, which is then purified by the usual manner.



Chapter 10: Preparation of Nerve Agents



Reaction equation (by-products omitted)

<b>Materials:</b>	1. 10 grams of phosphorus trichloride	6. 3.1 grams of sodium fluoride
	2. 9.7 grams of anhydrous aluminum chloride	7. 4 grams of anhydrous isopropyl alcohol
	3. 11 grams of methyl chloride	8. 30 grams of dry silica gel
	4. 146 milliliters of methylene chloride	9. 200+ milliliters of isopropyl ether
	5. 18.4 milliliters of 35 to 37% hydrochloric acid	10. 50 milliliters of toluene

**Hazards:**



**WARNING! WARNING! WARNING!**

Do not attempt in anyway to prepare sarin using the following procedure unless proper safety precautions are taken. 1) Perform all operations in a clean box, which is treated with a nitrogen atmosphere, and in which is completely sealed from the air. 2) After each procedure, all glassware and non-electric equipment should be soaked in a bleach (sodium hypochlorite) solution before removing from the clean box. Any electrical equipment such as hot plates and stirring equipment should be carefully wiped down with a bleached soaked rag before removing from the clean box. 3) After the entire operation is complete, the entire clean box should be disinfected with bleach before opening the clean box to the air. 4) The desired sarin product should be stored in amber bottles, preferably non-breakable containers, and stored in a cool dry place away from sunlight. The bottles should also be placed inside an airtight sealed plastic bag, such as a 'ziplock' bag. 5) Storage of any and nerve agents should be in airtight cabinets, drawers, or the like, and said storage spaces should be equipped with chemical agent detection monitors to alert of any potential leakage.

Use caution when handling methyl phosphonic dichloride, which is highly toxic, and can be absorbed through the skin causing mild nerve agent symptoms. Use care when handling phosphorus trichloride, and aluminum chloride, both of which can cause irritation of the skin and eyes, and both of which violently react with water evolving corrosive and toxic fumes. Avoid inhalation of toluene vapors, as they are potentially carcinogenic. Wear gloves when handling sodium fluoride, and avoid ingestion and skin absorption. Wear gloves when handling concentrated hydrochloric acid, and avoid inhalation of the vapors.

**Procedure:**

Step 1: Preparation of methyl phosphonic dichloride



## Chapter 10: Preparation of Nerve Agents

Place 10 grams of pure phosphorus trichloride, 9.7 grams of pure anhydrous aluminum chloride, and a lecture bottle of anhydrous methyl chloride into a freezer, and chill to 0 Celsius prior to the following: Into a suitable glass stoppered bottle, place 9.7 grams of cold anhydrous aluminum chloride, and then 10 grams of cold phosphorus trichloride. Shortly thereafter, transfer in 11 grams of liquid methyl chloride. Then, stopper the bottle, and then shake the bottle for 1 hour to dissolve all solids. Note: Use caution as heat of reaction may boil-off some of the liquid methyl chloride producing dangerous pressures. If need be, the liquid methyl chloride can be replaced by rapidly bubbling 11 grams of ice cold methyl chloride gas into the phosphorus trichloride/aluminum chloride mixture, followed by stoppering the flask, and then shaking for 1 hour to dissolve all solids. After 1 hour, stop shaking, and then place the stoppered flask into a freezer and chill at 0 Celsius for 24 hours. After 24 hours, filter-off the precipitated solid, and then allow it dry in a desiccator filled with anhydrous sodium sulfate. When the solid is thoroughly dry, dissolve it into 146 milliliters of methylene chloride, and then chill this mixture to 0 Celsius by use of an ice bath. Then, place 18.4 milliliters of cold 35 to 37% hydrochloric acid into an addition funnel, and then add this acid, drop wise (at the rate of 10 drops per minute), to the methylene chloride mixture. Stir the methylene chloride mixture thoroughly during the addition of the hydrochloric acid. After the addition of the hydrochloric acid, continue to stir the reaction mixture for 90 minutes, while keeping the temperature at 5 Celsius or lower during the whole time. After stirring for 2 hours, filter-off any insoluble impurities, and then remove the upper water layer using a separatory funnel. Thereafter, place the methylene chloride layer into a distillation apparatus, or rotary evaporator, and then remove the methylene chloride solvent under vacuum. Note: if vacuum apparatus is unavailable, carefully distilling-off the methylene chloride at 40 Celsius can be used. After the solvent has been removed, place the remaining material into a clean rotary evaporator, or vacuum distillation apparatus, and distil the methyl phosphonic dichloride at 28 millimeters of mercury to obtain a semi-solid colorless mass, or clear liquid of methyl phosphonic dichloride.

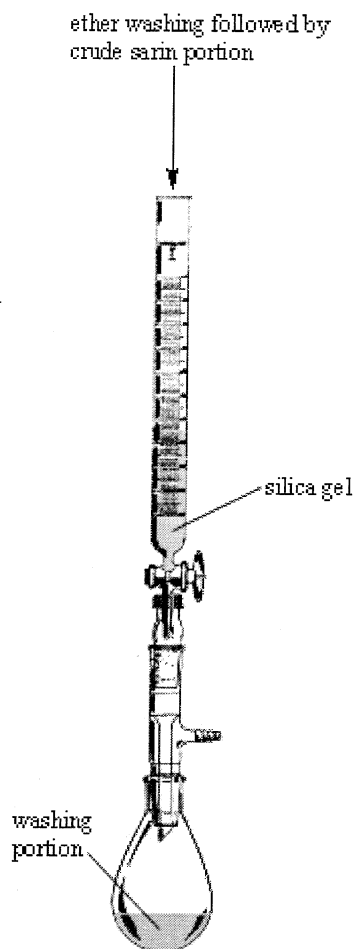
### Step 2: Preparation of sarin

Into a suitable flask, place 50 milliliters of anhydrous toluene, 3.1 grams of anhydrous sodium fluoride, and then 4 grams of anhydrous isopropyl alcohol. Thereafter stir the mixture at room temperature for 15 minutes or until all ingredients are dissolved. Then heat the mixture to 80 Celsius under reflux, and when the temperature reaches 80 Celsius, slowly add portion wise, 10 grams of the product obtained in step 1. After the addition of the methyl phosphonic dichloride product obtained in step 1, continue to stir the reaction mixture, and then reflux the reaction mixture at 80 Celsius for about 1 hour. After 1 hour, remove the heat source, and allow the reaction mixture to cool to room temperature. Thereafter, filter the reaction mixture to remove any insoluble impurities, and then place the filtered reaction mixture into a rotary evaporator, and evaporate-off the toluene under vacuum. **Note: The toluene mixture can be used directly in chemical warfare operations, when disseminated properly.** When all the toluene has been removed, remove the remaining residue, and then place said residue into a clean vacuum distillation apparatus, and distill the sarin at 56 Celsius under a vacuum of 16 millimeters of mercury to obtain a crude sarin product. **Note: This crude sarin product need not be purified for use in chemical warfare operations. Purification of the sarin is only desired if the sarin is to be mixed with other agents.**

### Step 3: Purification

Setup the apparatus displayed in figure 046, thereafter prepare the silica gel with the following process: Pour 200 milliliters of distilled water into a suitable beaker, and then slowly pour in 30 grams of dry silica gel of 50 to 200 mesh while gradually stirring the mixture. After the addition of the silica gel, rapidly stir the mixture for 15 minutes, and thereafter, carefully decant-off the "fines". The fines are particles of matter that need to be removed to ensure a good flow rate. Then pour the silica gel into the glass column (make sure the glass column's stopcock is closed), as pictured in the following figure. Thereafter, pour in distilled water until the glass column is nearly full. Then gently open the stopcock, and drain off most of the water, until only about 10 centimeters of water remains above the silica gel layer. Then add 50 milliliters of dry isopropyl ether into the glass column, and then carefully drain-off the ether until most of it has passed through (by this time most of the water should have been removed). Thereafter, close the stopcock, and then add enough isopropyl ether into the glass column until the glass column is nearly full. Then, gently open the stopcock, and begin a very slow drip of the ether, and then at the same time, pour the crude sarin product, obtained in step 2, into the glass column, and allow it to slowly pass through the glass column, drip by drip. Now when the total liquid layer is about 10 centimeters above the silica gel layer, close the stopcock. Immediately thereafter, remove the washing portion from the apparatus (remove the receiver flask at the bottom), and pour the contents into a clean beaker. Then replace said receiver flask with a clean one, and then pour enough fresh isopropyl ether into the glass column until the glass column is nearly full (make sure the stopcock is closed). Then open the stopcock to form a gentle drip, and then immediately add in the ether-washing portion (containing the sarin) contained in the beaker into the glass column. Allow most of the ether to drain into the receiver flask. After which, remove the receiver flask from the apparatus, and then remove any water by placing the mixture into a separatory funnel, and draining off the bottom water layer. After any water has been removed, place the ether mixture into a clean rotary evaporator, and distill-off the isopropyl ether under mild vacuum. When all the ether has been removed, take out the remaining residue, and place into a clean vacuum distillation apparatus. Then vacuum distill the sarin at 56 Celsius under a vacuum of 16 millimeters of mercury to obtain a purified sarin product, well suitable for use in chemical warfare cocktails. **Note: instead of distilling-off the isopropyl ether, the ether mixture may be used in chemical warfare operations, and is actually preferred as a method of storing, preserving, and protecting the sarin from decomposition. Mixtures of sarin with ether, or methylene chloride can be effectively used to disseminate the sarin in wartime operations. Mixtures of sarin in a**

solvent such as methylene chloride or ether may persist up to two or three times longer than straight sarin in wartime operations.

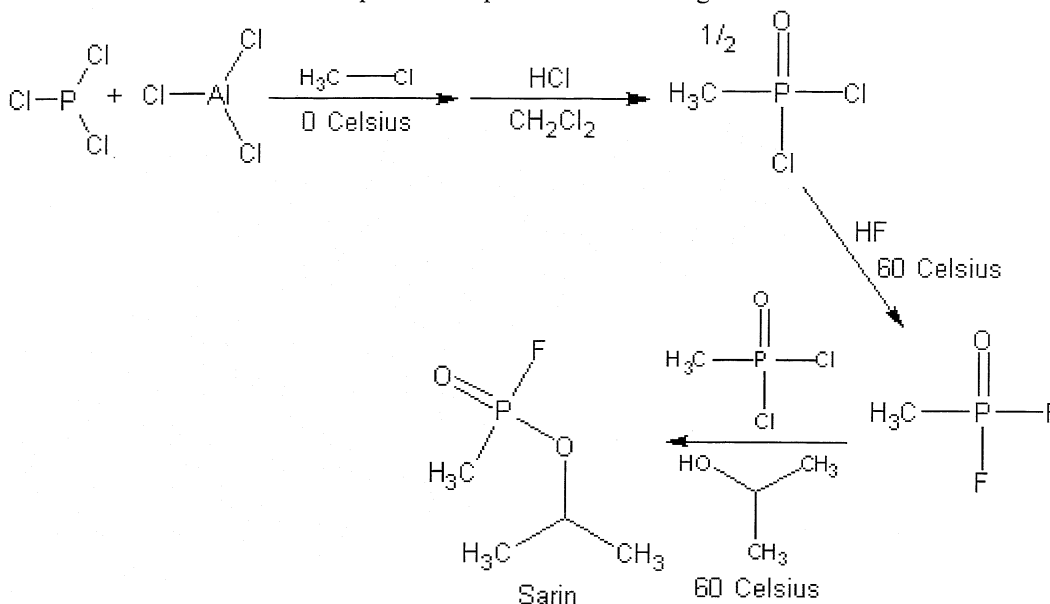


**Figure 046.** Apparatus for purification of sarin. Make sure the glass column has a glass-fritted disc at the bottom, to keep the silica gel from flowing out when the stopcock is open.

#### **Procedure 04-001B: Preparation of Sarin (preferred procedure)**

**Summary:** Sarin is easily prepared using a convenient three-step process, starting with the preparation of methyl phosphonic dichloride. The methyl phosphonic dichloride is easily made by reacting methyl chloride, and phosphorus trichloride in the presence of anhydrous aluminum chloride to form an insoluble complex. This insoluble complex is then recovered by filtration, dissolved in suitable solvent, and then hydrolyzed with concentrated hydrochloric acid. The hydrolyzed product is the methyl phosphonic dichloride. Half this product is then treated with hydrofluoric acid to produce methyl phosphonic difluoride. The fluoride intermediate is then treated with the other half of methyl phosphonic dichloride, and the mixture then treated with isopropyl alcohol. Step 3 is the purification process, which utilizes the standard silica gel column method.

Chapter 10: Preparation of Nerve Agents



Reaction equation (by-products omitted)

<b>Materials:</b>	1. 10 grams of phosphorus trichloride	6. 3.1 grams of 48% hydrofluoric acid
	2. 9.7 grams of anhydrous aluminum chloride	7. 4 grams of anhydrous isopropyl alcohol
	3. 11 grams of methyl chloride	8. 30 grams of dry silica gel
	4. 246 milliliters of methylene chloride	9. 200+ milliliters of isopropyl ether
	5. 18.4 milliliters of 35 to 37% hydrochloric acid	

**Hazards:**



**WARNING! WARNING! WARNING!**

Do not attempt in anyway to prepare sarin using the following procedure unless proper safety precautions are taken. 1) Perform all operations in a clean box, which is treated with a nitrogen atmosphere, and in which is completely sealed from the air. 2) After each procedure, all glassware and non-electric equipment should be soaked in a bleach (sodium hypochlorite) solution before removing from the clean box. Any electrical equipment such as hot plates and stirring equipment should be carefully wiped down with a bleached soaked rag before removing from the clean box. 3) After the entire operation is complete, the entire clean box should be disinfected with bleach before opening the clean box to the air. 4) The desired sarin product should be stored in amber bottles, preferably non-breakable containers, and stored in a cool dry place away from sunlight. The bottles should also be placed inside an airtight sealed plastic bag, such as a 'ziplock' bag. 5) Storage of any and all nerve agents should be in airtight cabinets, drawers, or the like, and said storage spaces should be equipped with chemical agent detection monitors to alert of any potential leakage.

Use caution when handling methyl phosphonic dichloride, which is highly toxic, and can be absorbed through the skin causing mild nerve agent symptoms. Use care when handling phosphorus trichloride, and aluminum chloride, both of which can cause irritation of the skin and eyes, and both of which violently react with water evolving corrosive and toxic fumes. Use great care when handling hydrofluoric acid. The acid is highly toxic, and can cause sever tissue, and bone damage. Acid spilled on the skin should immediately be washed with large amounts of water, and a baking soda solution. Any personnel exposed to hydrofluoric acid upon the skin, or accidentally ingested should seek a hospital emergency room immediately for treatment. Wear gloves when handling concentrated hydrochloric acid, and avoid inhalation of the vapors.

**Procedure:**

## Step 1: Preparation of methyl phosphonic dichloride

Place 10 grams of pure phosphorus trichloride, 9.7 grams of pure anhydrous aluminum chloride, and a lecture bottle of anhydrous methyl chloride into a freezer, and chill to 0 Celsius prior to the following: Into a suitable glass stoppered bottle, place 9.7 grams of cold anhydrous aluminum chloride, and then 10 grams of cold phosphorus trichloride. Shortly thereafter, transfer in 11 grams of liquid methyl chloride. Then, stopper the bottle, and then shake the bottle for 1 hour to dissolve all solids. Note: Use caution as heat of reaction may boil-off some of the liquid methyl chloride producing dangerous pressures. If need be, the liquid methyl chloride can be replaced by rapidly bubbling 11 grams of ice cold methyl chloride gas into the phosphorus trichloride/aluminum chloride mixture, followed by stoppering the flask, and then shaking for 1 hour to dissolve all solids. After 1 hour, stop shaking, and then place the stoppered flask into a freezer and chill at 0 Celsius for 24 hours. After 24 hours, filter-off the precipitated solid, and then allow it dry in a desiccator filled with anhydrous sodium sulfate. When the solid is thoroughly dry, dissolve it into 146 milliliters of methylene chloride, and then chill this mixture to 0 Celsius by use of an ice bath. Then, place 18.4 milliliters of cold 35 to 37% hydrochloric acid into an addition funnel, and then add this acid, drop wise (at the rate of 10 drops per minute), to the methylene chloride mixture. Stir the methylene chloride mixture thoroughly during the addition of the hydrochloric acid. After the addition of the hydrochloric acid, continue to stir the reaction mixture for 90 minutes, while keeping the temperature at 5 Celsius or lower during the whole time. After stirring for 2 hours, filter-off any insoluble impurities, and then remove the upper water layer using a separatory funnel. Thereafter, place the methylene chloride layer into a distillation apparatus, or rotary evaporator, and then remove the methylene chloride solvent under vacuum. Note: if vacuum apparatus is unavailable, carefully distilling-off the methylene chloride at 40 Celsius can be used. After the solvent has been removed, place the remaining material into a clean rotary evaporator, or vacuum distillation apparatus, and distil the methyl phosphonic dichloride at 28 millimeters of mercury to obtain a semi-solid colorless mass, or clear liquid of methyl phosphonic dichloride.

## Step 2: Preparation of sarin

Take 10 grams of the product obtained in step 1, place 5 grams of it into a suitable flask, and then add 50 milliliters of methylene chloride. Then cool the flask to 0 Celsius by means of an ice bath. When the temperature of the methylene chloride mixture reaches 0 Celsius, slowly add, drop-wise, 3.1 grams of 48% hydrofluoric acid. During the addition, stir the reaction mixture and keep its temperature around 0 Celsius. After the addition, stir the reaction mixture for 1 hour at 0 Celsius. After 1 hour, remove the ice bath, and then remove the upper water layer using a separatory funnel. Thereafter, pour the bottom methylene chloride layer into reflux apparatus, and gently reflux the mixture at about 60 Celsius while stirring for 1 hour. Afterwards, remove the heat source, and allow the reaction mixture to cool to room temperature. Then add the other 5 grams of the product obtained in step 1, 50 additional milliliters of methylene chloride, and then stir the mixture at room temperature for 15 minutes. Then add drop-wise, 4 grams of anhydrous isopropyl alcohol over a sufficient time as to keep the reaction mixture around room temperature. During the addition, stir the reaction mixture. After the addition, continue to stir the reaction mixture at room temperature for about 1 hour, and then place the reaction mixture into a reflux apparatus, and reflux at 60 Celsius for 1 hour. Thereafter, filter-off any precipitated impurities, and then place the filtered reaction mixture into a rotary evaporator or vacuum distillation apparatus, and remove the methylene chloride solvent under mild vacuum. If vacuum apparatus is not available, remove the methylene chloride by distillation at 40 Celsius. **Note: The methylene chloride mixture can be used directly in chemical warfare operations, when disseminated properly.** When the methylene chloride solvent has been evaporated, remove the remaining residue, and place it into a clean vacuum distillation apparatus, and distil the sarin at 56 Celsius under a vacuum of 16 millimeters of mercury to obtain a crude sarin product. **Note: this crude sarin product need not be purified for use in chemical warfare operations. Purification of the sarin is only desired if the sarin is to be mixed with other agents.**

## Step 3: Purification

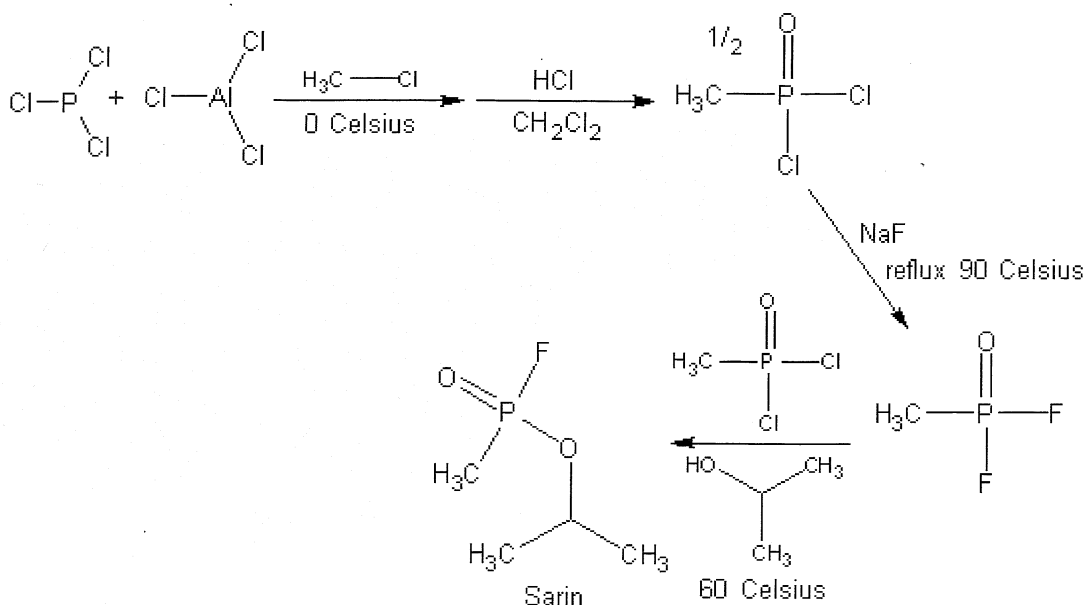
Setup the apparatus displayed in figure 046, thereafter prepare the silica gel with the following process: Pour 200 milliliters of distilled water into a suitable beaker, and then slowly pour in 30 grams of dry silica gel of 50 to 200 mesh while gradually stirring the mixture. After the addition of the silica gel, rapidly stir the mixture for 15 minutes, and thereafter, carefully decant-off the "fines". The fines are particles of matter that need to be removed to ensure a good flow rate. Then pour the silica gel into the glass column (make sure the glass column's stopcock is closed), as pictured in the following figure. Thereafter, pour in distilled water until the glass column is nearly full. Then gently open the stopcock, and drain off most of the water, until only about 10 centimeters of water remains above the silica gel layer. Then add 50 milliliters of dry isopropyl ether into the glass column, and then carefully drain-off the ether until most of it has passed through (by this time most of the water should have been removed). Thereafter, close the stopcock, and then add enough isopropyl ether into the glass column until the glass column is nearly full. Then, gently open the stopcock, and begin a very slow drip of the ether, and then at the same time, pour the crude sarin product, obtained in step 2, into the glass column, and allow it to slowly pass through the glass column, drip by drip. Now when the total liquid layer is about 10 centimeters above the silica gel layer, close the stopcock. Immediately thereafter, remove the washing portion from the apparatus (remove the receiver flask at the bottom), and pour the contents into a clean beaker. Then replace said receiver flask with a clean one, and then pour enough fresh isopropyl ether into the glass column until the glass column is nearly full (make sure the stopcock is closed). Then open the stopcock to form a gentle drip, and then immediately add in the ether-washing portion (containing the sarin) contained in the beaker into the glass column.

## Chapter 10: Preparation of Nerve Agents

Allow most of the ether to drain into the receiver flask. After which, remove the receiver flask from the apparatus, and then remove any water by placing the mixture into a separatory funnel, and draining off the bottom water layer. After any water has been removed, place the ether mixture into a clean rotary evaporator, and distill-off the isopropyl ether under mild vacuum. When all the ether has been removed, take out the remaining residue, and place into a clean vacuum distillation apparatus. Then vacuum distill the sarin at 56 Celsius under a vacuum of 16 millimeters of mercury to obtain a purified sarin product, well suitable for use in chemical warfare cocktails. **Note: instead of distilling-off the isopropyl ether, the ether mixture may be used in chemical warfare operations, and is actually preferred as a method of storing, preserving, and protecting the sarin from decomposition. Mixtures of sarin with ether, or methylene chloride can be effectively used to disseminate the sarin in wartime operations. Mixtures of sarin in a solvent such as methylene chloride or ether may persist up to two or three times longer than straight sarin in wartime operations.**

### Procedure 04-001C: Preparation of Sarin (modified sodium fluoride process)

**Summary:** Sarin can be made using a modified process where by sodium fluoride is the fluorinating agent rather than the dangerous to handle hydrofluoric acid. The first step is the preparation of the already discussed methyl phosphonic dichloride. The second step is the preparation of the difluoride, which is accomplished by refluxing sodium fluoride with half of the methyl phosphonic dichloride. The resulting difluoride is then mixed with the other half of methyl phosphonic dichloride, and then treated with isopropyl alcohol. The sarin can then be purified using the usual methods.



*Reaction equation (by-products omitted)*

<b>Materials:</b>	1. 10 grams of phosphorus trichloride	6. 3.1 grams of sodium fluoride
	2. 9.7 grams of anhydrous aluminum chloride	7. 4 grams of anhydrous isopropyl alcohol
	3. 11 grams of methyl chloride	8. 30 grams of dry silica gel
	4. 246 milliliters of methylene chloride	9. 200+ milliliters of isopropyl ether
	5. 18.4 milliliters of 35 to 37% hydrochloric acid	10. 100 milliliters of toluene

#### Hazards:



**WARNING! WARNING! WARNING!**

Do not attempt in anyway to prepare sarin using the following procedure unless proper safety precautions are taken. 1) Perform all operations in a clean box, which is treated with a nitrogen atmosphere, and in which is completely sealed

## Chapter 10: Preparation of Nerve Agents

from the air. 2) After each procedure, all glassware and non-electric equipment should be soaked in a bleach (sodium hypochlorite) solution before removing from the clean box. Any electrical equipment such as hot plates and stirring equipment should be carefully wiped down with a bleached soaked rag before removing from the clean box. 3) After the entire operation is complete, the entire clean box should be disinfected with bleach before opening the clean box to the air. 4) The desired sarin product should be stored in amber bottles, preferably non-breakable containers, and stored in a cool dry place away from sunlight. The bottles should also be placed inside an airtight sealed plastic bag, such as a 'ziplock' bag. 5) Storage of any and all nerve agents should be in airtight cabinets, drawers, or the like, and said storage spaces should be equipped with chemical agent detection monitors to alert of any potential leakage. Use caution when handling methyl phosphonic dichloride, which is highly toxic, and can be absorbed through the skin causing mild nerve agent symptoms. Use care when handling phosphorus trichloride, and aluminum chloride, both of which can cause irritation of the skin and eyes, and both of which violently react with water evolving corrosive and toxic fumes. Avoid inhalation of toluene vapors, as they are potentially carcinogenic. Wear gloves when handling sodium fluoride, and avoid ingestion and skin absorption. Wear gloves when handling concentrated hydrochloric acid, and avoid inhalation of the vapors.

### Procedure:

#### Step 1: Preparation of methyl phosphonic dichloride

Place 10 grams of pure phosphorus trichloride, 9.7 grams of pure anhydrous aluminum chloride, and a lecture bottle of anhydrous methyl chloride into a freezer, and chill to 0 Celsius prior to the following: Into a suitable glass stoppered bottle, place 9.7 grams of cold anhydrous aluminum chloride, and then 10 grams of cold phosphorus trichloride. Shortly thereafter, transfer in 11 grams of liquid methyl chloride. Then, stopper the bottle, and then shake the bottle for 1 hour to dissolve all solids. Note: Use caution as heat of reaction may boil-off some of the liquid methyl chloride producing dangerous pressures. If need be, the liquid methyl chloride can be replaced by rapidly bubbling 11 grams of ice cold methyl chloride gas into the phosphorus trichloride/aluminum chloride mixture, followed by stoppering the flask, and then shaking for 1 hour to dissolve all solids. After 1 hour, stop shaking, and then place the stoppered flask into a freezer and chill at 0 Celsius for 24 hours. After 24 hours, filter-off the precipitated solid, and then allow it dry in a desiccator filled with anhydrous sodium sulfate. When the solid is thoroughly dry, dissolve it into 146 milliliters of methylene chloride, and then chill this mixture to 0 Celsius by use of an ice bath. Then, place 18.4 milliliters of cold 35 to 37% hydrochloric acid into an addition funnel, and then add this acid, drop wise (at the rate of 10 drops per minute), to the methylene chloride mixture. Stir the methylene chloride mixture thoroughly during the addition of the hydrochloric acid. After the addition of the hydrochloric acid, continue to stir the reaction mixture for 90 minutes, while keeping the temperature at 5 Celsius or lower during the whole time. After stirring for 2 hours, filter-off any insoluble impurities, and then remove the upper water layer using a separatory funnel. Thereafter, place the methylene chloride layer into a distillation apparatus, or rotary evaporator, and then remove the methylene chloride solvent under vacuum. Note: if vacuum apparatus is unavailable, carefully distilling-off the methylene chloride at 40 Celsius can be used. After the solvent has been removed, place the remaining material into a clean rotary evaporator, or vacuum distillation apparatus, and distill the methyl phosphonic dichloride at 28 millimeters of mercury to obtain a semi-solid colorless mass, or clear liquid of methyl phosphonic dichloride.

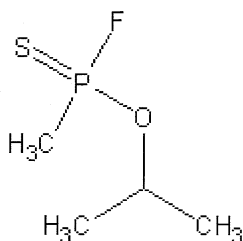
#### Step 2: Preparation of sarin

Take 10 grams of the product obtained in step 1, place 5 grams of it into a suitable flask, and then add 100 milliliters of toluene. Thereafter, add 3.1 grams of anhydrous sodium fluoride and then begin rapidly stirring the mixture. Then place the mixture into a reflux apparatus and reflux the mixture at 90 Celsius for 1 hour. After refluxing for 1 hour, remove the heat source, and then allow the reaction mixture to cool to room temperature. Thereafter, filter the reaction mixture to remove any insoluble impurities, and then place the filtered reaction mixture into a rotary evaporator, and evaporate-off the toluene under vacuum. When all the toluene has been removed, remove the remaining residue, and then place said residue into a clean flask, and then add 100 milliliters of methylene chloride, followed by the other 5 grams of the product obtained in step 1. Note: stir the mixture thereafter to dissolve the residue into the methylene chloride. Then add drop wise, 4 grams of anhydrous isopropyl alcohol over a period of about 5 minutes, while stirring the reaction mixture and maintaining the reaction mixture temperature at room temperature. After the addition of the isopropyl alcohol, continue to stir the reaction mixture for 1 hour at room temperature. Thereafter, reflux the reaction mixture at 60 Celsius for 1 hour while stirring. After the reflux period, remove the heat source and allow the reaction mixture to cool to room temperature. Then filter the reaction mixture to remove any insoluble impurities, and then place the filtered reaction mixture into a rotary evaporator and evaporate-off the methylene chloride under mild vacuum. If vacuum apparatus is unavailable, distill-off the methylene chloride at 40 Celsius. **Note: The methylene chloride mixture can be used directly in chemical warfare operations, when disseminated properly.** When the methylene chloride has been removed, remove the remaining residue and place into a clean vacuum distillation apparatus, and distill the sarin at 56 Celsius under a vacuum of 16 millimeters of mercury to obtain a crude sarin product **Note: this crude sarin product need not be purified for use in chemical warfare operations. Purification of the sarin is only desired if the sarin is to be mixed with other agents.**

## Step 3: Purification

Setup the apparatus displayed in figure 046, thereafter prepare the silica gel with the following process: Pour 200 milliliters of distilled water into a suitable beaker, and then slowly pour in 30 grams of dry silica gel of 50 to 200 mesh while gradually stirring the mixture. After the addition of the silica gel, rapidly stir the mixture for 15 minutes, and thereafter, carefully decant-off the "fines". The fines are particles of matter that need to be removed to ensure a good flow rate. Then pour the silica gel into the glass column (make sure the glass column's stopcock is closed), as pictured in the following figure. Thereafter, pour in distilled water until the glass column is nearly full. Then gently open the stopcock, and drain off most of the water, until only about 10 centimeters of water remains above the silica gel layer. Then add 50 milliliters of dry isopropyl ether into the glass column, and then carefully drain-off the ether until most of it has passed through (by this time most of the water should have been removed). Thereafter, close the stopcock, and then add enough isopropyl ether into the glass column until the glass column is nearly full. Then, gently open the stopcock, and begin a very slow drip of the ether, and then at the same time, pour the crude sarin product, obtained in step 2, into the glass column, and allow it to slowly pass through the glass column, drip by drip. Now when the total liquid layer is about 10 centimeters above the silica gel layer, close the stopcock. Immediately thereafter, remove the washing portion from the apparatus (remove the receiver flask at the bottom), and pour the contents into a clean beaker. Then replace said receiver flask with a clean one, and then pour enough fresh isopropyl ether into the glass column until the glass column is nearly full (make sure the stopcock is closed). Then open the stopcock to form a gentle drip, and then immediately add in the ether-washing portion (containing the sarin) contained in the beaker into the glass column. Allow most of the ether to drain into the receiver flask. After which, remove the receiver flask from the apparatus, and then remove any water by placing the mixture into a separatory funnel, and draining off the bottom water layer. After any water has been removed, place the ether mixture into a clean rotary evaporator, and distill-off the isopropyl ether under mild vacuum. When all the ether has been removed, take out the remaining residue, and place into a clean vacuum distillation apparatus. Then vacuum distill the sarin at 56 Celsius under a vacuum of 16 millimeters of mercury to obtain a purified sarin product, well suitable for use in chemical warfare cocktails. **Note: instead of distilling-off the isopropyl ether, the ether mixture may be used in chemical warfare operations, and is actually preferred as a method of storing, preserving, and protecting the sarin from decomposition. Mixtures of sarin with ether, or methylene chloride can be effectively used to disseminate the sarin in wartime operations. Mixtures of sarin in a solvent such as methylene chloride or ether may persist up to two or three times longer than straight sarin in wartime operations.**

**04-002. Thiosarin. GS. Sulfur sarin. *Isopropylethylthiophosphorusfluoridate;*  
*Isopropoxyethylthiophosphorus fluoride; O-isopropyl methylphosphonofluoridothioate***



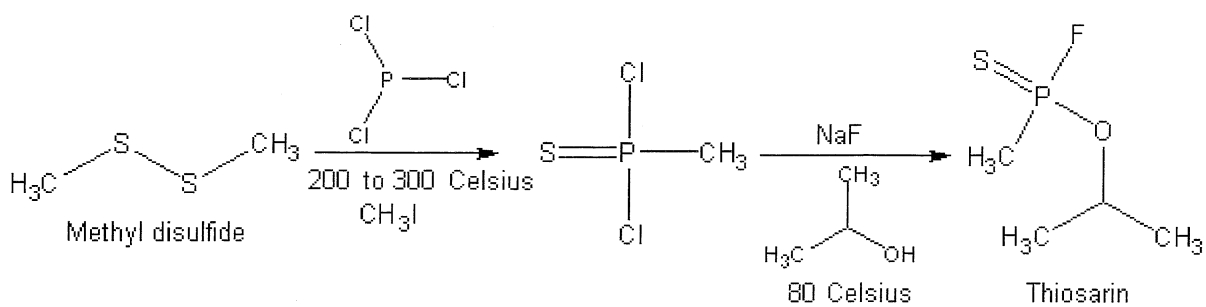
Thiosarin

Very little data was obtainable on thiosarin. Thiosarin appears to be a liquid, most likely a clear liquid when pure, and rather amber to brown when impure. It has a boiling point of 144 to 160 Celsius at 760 millimeters of mercury, and it can be distilled at 10 millimeters of mercury at 32 to 48 Celsius. It probably has no odor, but impure thiosarin probably has an odor similar to impure sarin. Thiosarin volatilizes quite readily into a colorless odorless vapor. It is only very slightly soluble in water (7 grams per liter) being slowly hydrolyzed, and it is very soluble in the usual organic solvents. Through simple observation it is evident that thiosarin would be more persistent than sarin, and would have a greater half-life than sarin due to the sulfur-phosphorus bond. The phosphorus-fluorine bond would definitely show some hydrolysis effect with water, but to a lesser extent than for sarin. It is safe to assume that thiosarin would have similar toxicity as that of sarin, but because of the sulfur-phosphorus bond, thiosarin would probably have significant delayed biological activity, making it more or less effective as a "nerve agent". Thiosarin may be less effective than sarin, but may detoxify slower than sarin, increasing its overall long-term effectiveness as a nerve agent. The potential for thiosarin to act as an effective nerve agent is probable. Thiosarin can be effectively disseminated through aerosols, explosives munitions, atomizers or humidifiers, or foggers. **Thiosarin is a moderate fast acting nerve agent capable of producing casualties within 24 to 48 hours after dissemination or exposure by personnel. The lethal dose in the average man is probably 1.5 to 4.5 milligrams by inhalation. Skin absorption or ingestion is more rapid than sarin, due to the sulfur-phosphorus bond. Thiosarin is highly toxic through ingestion, inhalation, and skin and eye absorption.**

OVERALL RATING (scale from 1 to 10)	
Effectiveness (as nerve agent): 6	Field Stability: 7
Persistence (open area): 8	Storage stability: 7
Persistence (enclosed area): 9	Toxicity (as nerve agent): 6
TOTAL EFFECTIVENESS (as nerve agent): 7.1	
OVERALL TOXICITY (as warfare agent): 6¾	

### Procedure 04-002A: Preparation of Thiosarin

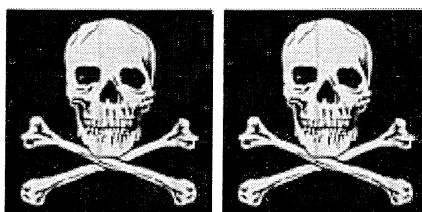
**Summary:** Thiosarin is prepared in a two-step process starting with the formation of methyl thiophosphorus dichloride. The thiophosphorus dichloride is prepared by thermally reacting phosphorus trichloride with methyl disulfide under heat and pressure. The resulting thiophosphorus dichloride is then recovered by fractional distillation under vacuum. In this procedure, there are included two methods of preparing methyl thiophosphorus dichloride (step 1B is a modified process utilizing a methyl iodide catalyst). The thiosarin is then easily prepared by reacting the methyl thiophosphorus dichloride with sodium fluoride and isopropyl alcohol in toluene. Recovery of the thiosarin is accomplished by vacuum distillation using the normal techniques. Note: The preparation of methyl thiophosphorus dichloride discussed in step 1A and step 1B, is similar or related to the process discussed in serial number 515,754 December 22<sup>nd</sup>, 1965 by Joseph W. Baker of Kirkwood Missouri; Raymond E. Stenseth of St. Louise Missouri, assigned by Monsanto Company. This process may be protected by industrial/commercial process applications. Consult said application number before using the mentioned process for commercial or industrial purposes.



#### Reaction Equation (by-products omitted)

<b>Materials:</b>	1. 274.8 grams of phosphorus trichloride	6. 50 milliliters of toluene
	2. or 76 grams of phosphorus trichloride	7. 4.2 grams of anhydrous sodium fluoride
	3. 190.2 grams of methyl disulfide	8. 6 grams of anhydrous isopropyl alcohol
	4. or 54 grams of methyl disulfide	
	5. 4.6 grams of methyl iodide	

#### Hazards:



**WARNING! WARNING!**

Do not attempt in anyway to prepare thiosarin using the following procedure unless proper safety precautions are taken. 1) Perform all operations in a clean box, which is treated with a nitrogen atmosphere, and in which is completely sealed from the air. 2) After each procedure, all glassware and non-electric equipment should be soaked in a bleach (sodium hypochlorite) solution before removing from the clean box. Any electrical equipment such as hot plates and stirring equipment should be carefully wiped down with a bleached soaked rag before removing from the clean box. 3) After the entire operation is complete, the entire clean box should be disinfected with bleach before opening the clean box to the air. 4) The desired thiosarin product should be stored in amber bottles, preferably non-breakable containers, and stored in a cool dry place away from sunlight. The bottles should also be placed inside an airtight sealed plastic bag, such as a 'ziplock' bag. 5) Storage of any and all nerve agents should be in airtight cabinets, drawers, or the like, and said storage spaces should be equipped with chemical agent detection monitors to alert of any potential leakage.



## Chapter 10: Preparation of Nerve Agents

Use caution when handling methyl thiophosphorus dichloride, which is highly toxic, and can be absorbed through the skin causing mild nerve agent symptoms. Use care when handling phosphorus trichloride, which can cause irritation of the skin and eyes, and which violently reacts with water evolving corrosive and toxic fumes. Avoid inhalation of toluene vapors, as they are potentially carcinogenic. Wear gloves when handling sodium fluoride, and avoid ingestion and skin absorption. Isopropyl alcohol is flammable, so extinguish all flames before using.

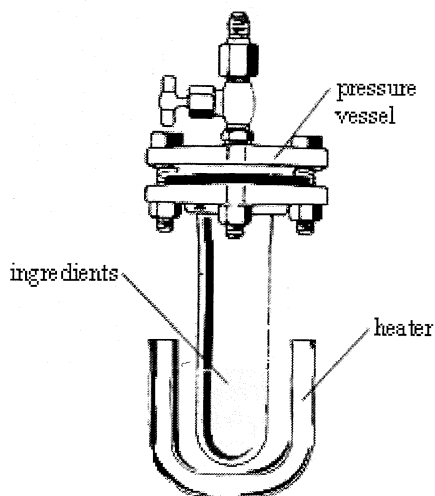
### Procedure:

#### Step 1A: Preparation of methyl thiophosphorus dichloride (method 1)

Into a pressure vessel (as shown in figure 047), place 190.2 grams of methyl disulfide, and then 274.8 grams of phosphorus trichloride. Thereafter seal the pressure vessel, and heat the ingredients in the pressure vessel to 275 Celsius. Continue to heat the ingredients in the pressure vessel at 275 Celsius for 12 hours. Note: Read your pressure vessel operators manual thoroughly before using such pressure vessel. Pressure vessels can lead to dangerous explosions if not used properly. After heating for 12 hours, remove the heat source, and allow the reaction mixture ingredients to cool to room temperature. Thereafter, open the pressure vessel (use caution, as great pressure will be relieved; mostly in the form of gaseous methyl chloride by-product). After opening the pressure vessel, remove the contents there from, and place into a clean vacuum distillation apparatus, and fractionally distill the product at 70 Celsius under a vacuum of 50 millimeters of mercury to obtain the methyl thiophosphorus dichloride.

#### Step 1B: Modified preparation for methyl thiophosphorus dichloride (this step can be used in place of step 1A for the preparation of methyl thiophosphorus dichloride)

Into a pressure vessel (as shown in figure 047), place 54 grams of methyl disulfide, then 76 grams of phosphorus trichloride, and then add 4.6 grams of methyl iodide. Thereafter seal the pressure vessel, and heat the ingredients in the pressure vessel to 260 Celsius. Continue to heat the ingredients in the pressure vessel at 260 Celsius for 8 hours. Note: Read your pressure vessel operators manual thoroughly before using such pressure vessel. Pressure vessels can lead to dangerous explosions if not used properly. After heating for 8 hours, remove the heat source, and allow the reaction mixture ingredients to cool to room temperature. Thereafter, open the pressure vessel (use caution, as great pressure will be relieved; mostly in the form of gaseous methyl chloride by-product). After opening the pressure vessel, remove the contents there from, and place into a clean vacuum distillation apparatus, and fractionally distill the product at 70 Celsius under a vacuum of 50 millimeters of mercury to obtain the methyl thiophosphorus dichloride.



**Figure 047. A standard laboratory pressure vessel. Read your operators manual thoroughly before using said vessel. Pressure vessels can lead to violent explosions (pressure explosions), if used improperly.**

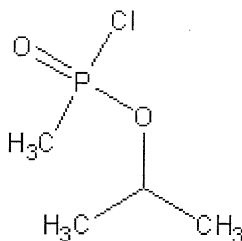
#### Step 2: Preparation of thiosarin

Into a suitable flask, place 50 milliliters of toluene, and then add 4.2 grams of anhydrous sodium fluoride. Thereafter, add 6 grams of anhydrous isopropyl alcohol, and then stir the mixture at room temperature for several minutes. Then heat the mixture to about 80 Celsius under reflux, and then carefully add portion-wise, 15 grams of the product obtained in step 1A or step 1B. During the addition, stir the reaction mixture and maintain its temperature at 80 Celsius. After the addition, continue to heat the reaction mixture at 80 Celsius, and continue stirring for an additional 60 minutes. After heating and stirring for 60 minutes, remove the heat source, and

## Chapter 10: Preparation of Nerve Agents

allow the reaction mixture to cool to room temperature. Then filter-off any insoluble impurities, and then place the filtered reaction mixture into a rotary evaporator or vacuum distillation apparatus and remove the toluene under vacuum. When all the toluene has been removed, remove the remaining residue, and place into a clean vacuum distillation apparatus, and distill the thiosarin at 10 millimeters of mercury at 32 to 48 Celsius to obtain a refined thiosarin product. Purification if desired, may be carried out by using a silica gel column filled with aluminum oxide, or silica.

### 04-003. ChloroSarin. ClGB; *Isopropylmethylphosphonochloridate*; *Isopropoxymethylphosphoryl chloride*;



Chlorosarin

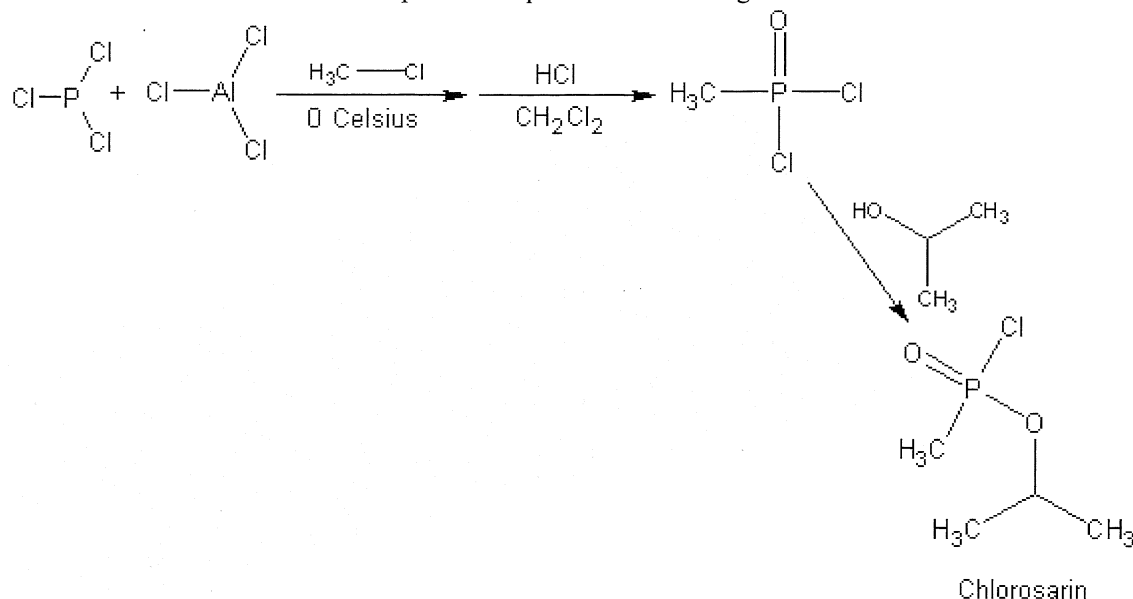
Chlorosarin is a colorless liquid with a boiling point of 160 to 180 Celsius at 760 millimeters of mercury (begins to decompose at 150+ Celsius). It can be distilled at 63 to 75 Celsius under a vacuum of 25 millimeters of mercury. It is only slightly soluble in water (142 grams a liter), but it is very soluble in the usual organic solvents. Chlorosarin is only slowly hydrolyzed by water. The persistence of chlorosarin is probably similar to sarin, but less volatile. Very little data exists on this substance so exact numbers are unknown. The use of chlorosarin for warfare is not probable, but it can be used in military training operations. It is also used for calibrating chemical warfare field detecting equipment. Chlorosarin produces the usual nerve agent symptoms, but with less severity than sarin; the toxicity of chlorosarin is also less. Chlorosarin can be disseminated using aerosols, explosives munitions, atomizers or humidifiers, and foggers. **Chlorosarin is a slow acting nerve agent capable of causing general casualties with 32 hours of dissemination or exposure by personnel. Toxicity in the average man ranges from 3 to 15 milligrams by inhalation. Chlorosarin is highly toxic through ingestion, inhalation, and skin and eye absorption.**

OVERALL RATING (scale from 1 to 10)	
<i>Effectiveness (as nerve agent): 5</i>	<i>Field Stability: 7</i>
<i>Persistence (open area): 8</i>	<i>Storage stability: 7</i>
<i>Persistence (enclosed area): 9</i>	<i>Toxicity (as nerve agent): 5½</i>
<b>TOTAL EFFECTIVENESS (as nerve agent): 6.9</b>	
<b>OVERALL TOXICITY (as warfare agent): 5¾</b>	

### Procedure 04-003A: Preparation of Chlorosarin

**Summary:** Chlorosarin is easily prepared in a two-step process starting with the preparation of methyl phosphonic dichloride. The methyl phosphonic dichloride is easily made by reacting methyl chloride, and phosphorus trichloride in the presence of anhydrous aluminum chloride to form an insoluble complex. This insoluble complex is then recovered by filtration, dissolved in suitable solvent, and then hydrolyzed with concentrated hydrochloric acid. The hydrolyzed product is the methyl phosphonic dichloride. The methyl phosphonic dichloride is then carefully treated with isopropyl alcohol to yield chlorosarin.

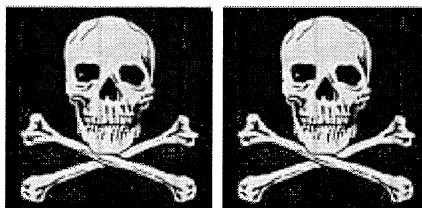
Chapter 10: Preparation of Nerve Agents



*Reaction Equation (by-products omitted)*

<b>Materials:</b>	1. 20 grams of phosphorus trichloride	6. 9 grams of anhydrous isopropyl alcohol
	2. 19.4 grams of anhydrous aluminum chloride	7. 40 grams of toluene
	3. 22 grams of methyl chloride	8. 10 grams of pyridine
	4. 292 milliliters of methylene chloride	9. 5 grams of anhydrous calcium chloride
	5. 36.8 milliliters of 35 to 37% hydrochloric acid	

**Hazards:**



**WARNING! WARNING!**

Do not attempt in anyway to prepare chlorosarin using the following procedure unless proper safety precautions are taken. 1) Perform all operations in a clean box, which is treated with a nitrogen atmosphere, and in which is completely sealed from the air. 2) After each procedure, all glassware and non-electric equipment should be soaked in a bleach (sodium hypochlorite) solution before removing from the clean box. Any electrical equipment such as hot plates and stirring equipment should be carefully wiped down with a bleached soaked rag before removing from the clean box. 3) After the entire operation is complete, the entire clean box should be disinfected with bleach before opening the clean box to the air. 4) The desired chlorosarin product should be stored in amber bottles, preferably non-breakable containers, and stored in a cool dry place away from sunlight. The bottles should also be placed inside an airtight sealed plastic bag, such as a 'ziplock' bag. 5) Storage of any and nerve agents should be in airtight cabinets, drawers, or the like, and said storage spaces should be equipped with chemical agent detection monitors to alert of any potential leakage.

Use caution when handling methyl phosphonic dichloride, which is highly toxic, and can be absorbed through the skin causing mild nerve agent symptoms. Use care when handling phosphorus trichloride, and aluminum chloride, both of which can cause irritation of the skin and eyes, and both of which violently react with water evolving corrosive and toxic fumes. Avoid inhalation of toluene vapors, as they are potentially carcinogenic. Wear gloves when handling concentrated hydrochloric acid, and avoid inhalation of the vapors.

**Procedure:**

Step 1: Preparation of methyl phosphonic dichloride

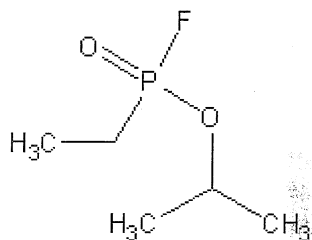
## Chapter 10: Preparation of Nerve Agents

Place 20 grams of pure phosphorus trichloride, 19.4 grams of pure anhydrous aluminum chloride, and a lecture bottle of anhydrous methyl chloride into a freezer, and chill to 0 Celsius prior to the following: Into a suitable glass stoppered bottle, place 19.4 grams of cold anhydrous aluminum chloride, and then 20 grams of cold phosphorus trichloride. Shortly thereafter, transfer in 22 grams of liquid methyl chloride. Then, stopper the bottle, and then shake the bottle for 1 hour to dissolve all solids. Note: Use caution as heat of reaction may boil-off some of the liquid methyl chloride producing dangerous pressures. If need be, the liquid methyl chloride can be replaced by rapidly bubbling 22 grams of ice cold methyl chloride gas into the phosphorus trichloride/aluminum chloride mixture, followed by stoppering the flask, and then shaking for 1 hour to dissolve all solids. After 1 hour, stop shaking, and then place the stoppered flask into a freezer and chill at 0 Celsius for 24 hours. After 24 hours, filter-off the precipitated solid, and then allow it dry in a desiccator filled with anhydrous sodium sulfate. When the solid is thoroughly dry, dissolve it into 292 milliliters of methylene chloride, and then chill this mixture to 0 Celsius by use of an ice bath. Then, place 36.8 milliliters of cold 35 to 37% hydrochloric acid into an addition funnel, and then add this acid, drop wise (at the rate of 10 drops per minute), to the methylene chloride mixture. Stir the methylene chloride mixture thoroughly during the addition of the hydrochloric acid. After the addition of the hydrochloric acid, continue to stir the reaction mixture for 90 minutes, while keeping the temperature at 5 Celsius or lower during the whole time. After stirring for 2 hours, filter-off any insoluble impurities, and then remove the upper water layer using a separatory funnel. Thereafter, place the methylene chloride layer into a distillation apparatus, or rotary evaporator, and then remove the methylene chloride solvent under vacuum. Note: if vacuum apparatus is unavailable, carefully distilling-off the methylene chloride at 40 Celsius can be used. After the solvent has been removed, place the remaining material into a clean rotary evaporator, or vacuum distillation apparatus, and distill the methyl phosphonic dichloride at 28 millimeters of mercury to obtain a semi-solid colorless mass, or clear liquid of methyl phosphonic dichloride.

### Step 2: Preparation of chlorosarin

Prepare a solution by adding and dissolving 20 grams of the product obtained in step 1 into 40 grams of toluene. Thereafter, add 10 grams of pyridine, and then stir the mixture for 10 minutes at room temperature. Then place the mixture into a cooling bath, and chill to about 0 Celsius by means of an ice. When the temperature of the mixture reaches 0 Celsius, add drop-wise, 9 grams of anhydrous isopropyl alcohol over a sufficient time as to maintain the reaction temperature around 0 Celsius. During the alcohol addition, rapidly stir the reaction mixture. After the alcohol addition, continue to stir reaction mixture for 1 hour at 0 Celsius. Thereafter, remove the cooling bath, and allow the reaction mixture to warm to room temperature, and thereafter stir the reaction mixture for 1 hour. Then pour the entire reaction mixture into 70 milliliters of ice water, and then stir the mixture for 10 minutes. Immediately thereafter, remove the upper toluene layer using a separatory funnel, or by decantation, and then add 5 grams of anhydrous calcium chloride, and stir the benzene layer for 5 minutes. Immediately thereafter, filter-off the insoluble calcium chloride, and then place the filtered toluene mixture into a rotary evaporator or vacuum distillation apparatus, and remove the benzene under vacuum, and under a temperature of 30 Celsius. After the benzene has been removed, place the remaining residue into a clean vacuum distillation apparatus, and distill the chlorosarin at 63 to 75 Celsius under a vacuum of 25 millimeters of mercury to obtain a refined chlorosarin product.

### 04-004. Sarin-Ethyl. GBE. Sarin-II. *Isopropylethylphosphonofluoridate; Isopropoxyethylphosphoryl fluoride;*



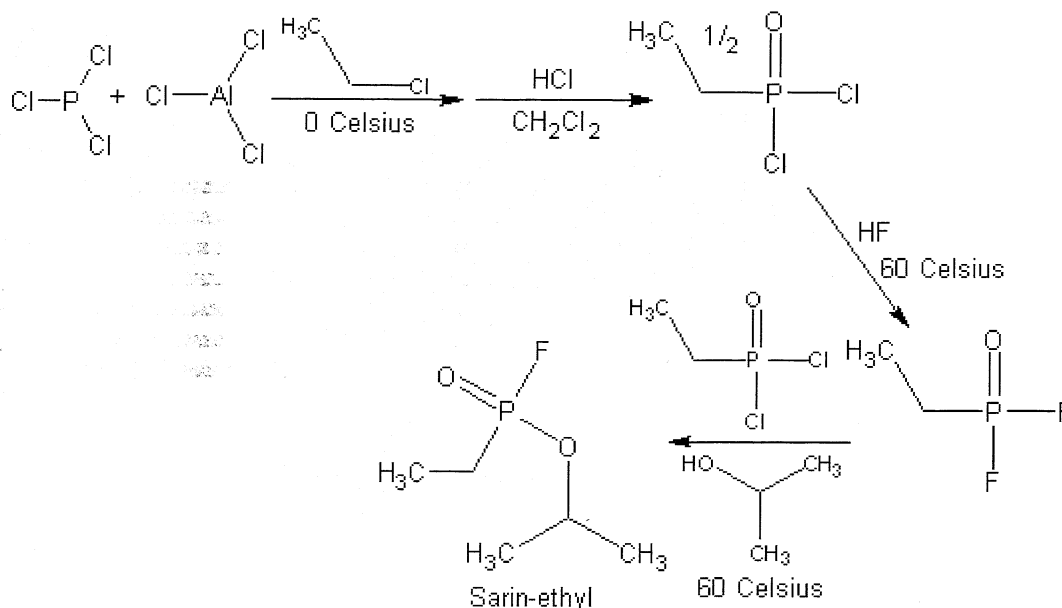
Sarin-Ethyl

Sarin-ethyl has similar physical properties to sarin, and similar environmental persistence. Little information exists on sarin-ethyl, but it is a colorless to light amber liquid, with a boiling point of 170 to 179 Celsius. It can be distilled at 66 to 73 Celsius under a vacuum of 20 millimeters of mercury. Its persistence would be greater than sarin, and it would hydrolyze in water at slower rates. It is only slightly soluble in water (84 grams per liter), but it is very soluble in the usual organic solvents. Sarin-ethyl could be used as a substitute for sarin. It can be disseminated using aerosols, explosives munitions, atomizers or humidifiers, or foggers. **Sarin-ethyl is a fast acting nerve agent capable of causing casualties within minutes of dissemination. Toxicity of sarin-ethyl is probably in the range of 950 micrograms to 2500 micrograms per person by inhalation. Sarin-ethyl is highly toxic through ingestion, inhalation, and skin and eye absorption.**

OVERALL RATING (scale from 1 to 10)	
Effectiveness (as nerve agent): 8	Field Stability: 7
Persistence (open area): 8	Storage stability: 8
Persistence (enclosed area): 9	Toxicity (as nerve agent): 7¼
TOTAL EFFECTIVENESS (as nerve agent): 7.9	
OVERALL TOXICITY (as warfare agent): 7½	

### Procedure 04-004A: Preparation of Sarin-ethyl

**Summary:** Sarin-ethyl is prepared in an identical way as for ordinary sarin. Sarin-ethyl is easily prepared using a convenient three-step process, starting with the preparation of ethyl phosphonic dichloride. The ethyl phosphonic dichloride is easily made by reacting ethyl chloride, and phosphorus trichloride in the presence of anhydrous aluminum chloride to form an insoluble complex. This insoluble complex is then recovered by filtration, dissolved in suitable solvent, and then hydrolyzed with concentrated hydrochloric acid. The hydrolyzed product is the ethyl phosphonic dichloride. Half this product is then treated with hydrofluoric acid to produce ethyl phosphonic difluoride. The difluoride intermediate is then treated with the other half of ethyl phosphonic dichloride, and the mixture then treated with isopropyl alcohol. Step 3 is the purification process, which utilizes the standard silica gel column method. Note: The preparation of ethyl phosphonic dichloride discussed in step 1, is similar or related to the process discussed in serial number 292,390 June 7<sup>th</sup>, 1952 by John P. Clay, assigned by Dugway Proving Grounds. This process may be protected by industrial/commercial process applications. Consult said application number before using the mentioned process for commercial or industrial processes.



*Reaction equation (by-products omitted)*

<b>Materials:</b>	1. 27.4 grams of phosphorus trichloride	6. 2.8 grams of 48% hydrofluoric acid
	2. 26.6 grams of anhydrous aluminum chloride	7. 4 grams of anhydrous isopropyl alcohol
	3. 38.6 grams of ethyl chloride	8. 30 grams of dry silica gel
	4. 500 milliliters of methylene chloride	9. 200+ milliliters of isopropyl ether
	5. 50.6 milliliters of 35 to 37% hydrochloric acid	

#### Hazards:



**WARNING! WARNING! WARNING!**

## Chapter 10: Preparation of Nerve Agents

Do not attempt in anyway to prepare sarin-ethyl using the following procedure unless proper safety precautions are taken. 1) Perform all operations in a clean box, which is treated with a nitrogen atmosphere, and in which is completely sealed from the air. 2) After each procedure, all glassware and non-electric equipment should be soaked in a bleach (sodium hypochlorite) solution before removing from the clean box. Any electrical equipment such as hot plates and stirring equipment should be carefully wiped down with a bleached soaked rag before removing from the clean box. 3) After the entire operation is complete, the entire clean box should be disinfected with bleach before opening the clean box to the air. 4) The desired sarin-ethyl product should be stored in amber bottles, preferably non-breakable containers, and stored in a cool dry place away from sunlight. The bottles should also be placed inside an airtight sealed plastic bag, such as a 'ziplock' bag. 5) Storage of any and all nerve agents should be in airtight cabinets, drawers, or the like, and said storage spaces should be equipped with chemical agent detection monitors to alert of any potential leakage.

Use caution when handling ethyl phosphonic dichloride, which is highly toxic, and can be absorbed through the skin causing mild nerve agent symptoms. Use care when handling phosphorus trichloride, and aluminum chloride, both of which can cause irritation of the skin and eyes, and both of which violently react with water evolving corrosive and toxic fumes. Use great care when handling hydrofluoric acid. The acid is highly toxic, and can cause sever tissue, and bone damage. Acid spilled on the skin should immediately be washed with large amounts of water, and a baking soda solution. Any personnel exposed to hydrofluoric acid upon the skin, or accidentally ingested should seek a hospital emergency room immediately for treatment. Wear gloves when handling concentrated hydrochloric acid, and avoid inhalation of the vapors.

### Procedure:

#### Step 1: Preparation of ethyl phosphonic dichloride

Into a suitable sized flask, place 26.6 grams of anhydrous aluminum chloride (pre-chilled in a freezer at 0 Celsius). Thereafter, add in 27.4 grams of pure phosphorus trichloride (also pre-chilled in a freezer at 0 Celsius), followed by 38.6 grams of anhydrous liquid ethyl chloride (from a lecture bottle, or liquid dispensed from proper container chilled to 0 Celsius). Then securely stopper the bottle, and then place into a shaking machine (if available), and rapidly shake the flask for 30 minutes until all solids dissolve (note: a slight increase in heat will result). Then place the sealed flask into a refrigerator at 5 Celsius for 24 hours. Note: During the shaking, pressure may build up; so occasional venting may be needed. When venting, just slightly open the flask to avoid excess air from entering the flask. After 24 hours, remove the flask from the refrigerator, and then filter-off the insoluble precipitate. The insoluble precipitate should then be vacuum dried, and then stored in a desiccator filled with inert drying agent such as anhydrous sodium sulfate for 24 hours. The result will be about 36 grams of the aluminum chloride/phosphorus trichloride/ethyl chloride complex. After drying the complex in the desiccator for 24 hours, remove it, and then dissolve it into 400 milliliters of methylene chloride contained in a suitable flask. Then place said flask into an ice bath and chill to 0 Celsius. Thereafter add drop wise, at the rate of about 10 drops per minute, 50.6 milliliters of 35 to 38% hydrochloric acid (pre-chilled to 0 Celsius) while stirring the methylene chloride mixture and maintaining its temperature around 0 Celsius. After the addition, continue to stir the reaction mixture at 0 Celsius for about 90 minutes. After 90 minutes, filter-off any insoluble impurities, and then place the filtered mixture into a separatory funnel, and then remove the upper water layer. Thereafter, place the lower methylene chloride layer into rotary evaporator, and evaporate off the methylene chloride under mild vacuum. If vacuum apparatus is unavailable, carefully distill-off the methylene chloride at 40 Celsius. After the methylene chloride has been removed, remove the remaining contents, and place into a clean vacuum distillation apparatus, and vacuum distill at 71 Celsius under a vacuum of 12 millimeters of mercury. The result will be about 14 grams of a semi-solid to liquid mass of ethyl phosphonic dichloride.

#### Step 2: Preparation of Sarin-ethyl

Too 10 grams of the product obtained in step 1, place 5 grams of it into a suitable flask, and then add 50 milliliters of methylene chloride. Then cool the flask to 0 Celsius by means of an ice bath. When the temperature of the methylene chloride mixture reaches 0 Celsius, slowly add, drop-wise, 2.8 grams of 48% hydrofluoric acid. During the addition, stir the reaction mixture and keep it's temperature around 0 Celsius. After the addition, stir the reaction mixture for 1 hour at 0 Celsius. After 1 hour, remove the ice bath, and then remove the upper water layer using a separatory funnel. Thereafter, pour the bottom methylene chloride layer into a reflux apparatus, and gently reflux the mixture at about 60 Celsius while stirring for 1 hour. Afterwards, remove the heat source, and allow the reaction mixture to cool to room temperature. Then add the other 5 grams of the product obtained in step 1, 50 additional milliliters of methylene chloride, and then stir the mixture at room temperature for 15 minutes. Then add drop-wise, 4 grams of anhydrous isopropyl alcohol over a sufficient time as to keep the reaction mixture around room temperature. During the addition, stir the reaction mixture. After the addition, continue to stir the reaction mixture at room temperature for about 1 hour, and then place the reaction mixture into a reflux apparatus, and reflux at 60 Celsius for 1 hour. Thereafter, filter-off any precipitated impurities, and then place the filtered reaction mixture into a rotary evaporator or vacuum distillation apparatus, and remove the methylene chloride solvent under mild vacuum. If vacuum apparatus is not available, remove the methylene chloride by distillation at 40 Celsius. **Note: The methylene chloride mixture can be used directly in chemical warfare operations, when disseminated properly.** When the

methylene chloride solvent has been evaporated, remove the remaining residue, and place it into a clean vacuum distillation apparatus, and distil the sarin-ethyl at 66 to 73 Celsius under a vacuum of 20 millimeters of mercury to obtain a crude sarin-ethyl product. **Note: this crude sarin-ethyl product need not be purified for use in chemical warfare operations. Purification of the sarin-ethyl is only desired if the sarin-ethyl is to be mixed with other agents.**

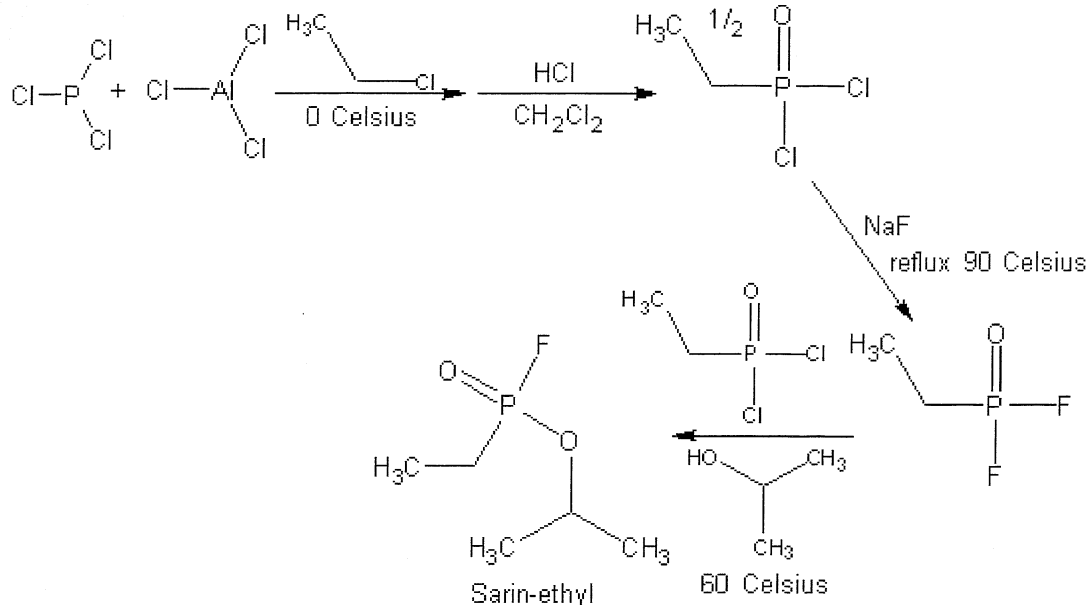
### Step 3: Purification of sarin-ethyl

Setup the apparatus displayed in figure 046, thereafter prepare the silica gel with the following process: Pour 200 milliliters of distilled water into a suitable beaker, and then slowly pour in 30 grams of dry silica gel of 50 to 200 mesh while gradually stirring the mixture. After the addition of the silica gel, rapidly stir the mixture for 15 minutes, and thereafter, carefully decant-off the "fines". The fines are particles of matter that need to be removed to ensure a good flow rate. Then pour the silica gel into the glass column (make sure the glass column's stopcock is closed), as pictured in the following figure. Thereafter, pour in distilled water until the glass column is nearly full. Then gently open the stopcock, and drain off most of the water, until only about 10 centimeters of water remains above the silica gel layer. Then add 50 milliliters of dry isopropyl ether into the glass column, and then carefully drain-off the ether until most of it has passed through (by this time most of the water should have been removed). Thereafter, close the stopcock, and then add enough isopropyl ether into the glass column until the glass column is nearly full. Then, gently open the stopcock, and begin a very slow drip of the ether, and then at the same time, pour the crude sarin-ethyl product, obtained in step 2, into the glass column, and allow it to slowly pass through the glass column, drip by drip. Now when the total liquid layer is about 10 centimeters above the silica gel layer, close the stopcock. Immediately thereafter, remove the washing portion from the apparatus (remove the receiver flask at the bottom), and pour the contents into a clean beaker. Then replace said receiver flask with a clean one, and then pour enough fresh isopropyl ether into the glass column until the glass column is nearly full (make sure the stopcock is closed). Then open the stopcock to form a gentle drip, and then immediately add in the ether-washing portion (containing the sarin-ethyl) contained in the beaker into the glass column. Allow most of the ether to drain into the receiver flask. After which, remove the receiver flask from the apparatus, and then remove any water by placing the mixture into a separatory funnel, and draining off the bottom water layer. After any water has been removed, place the ether mixture into a clean rotary evaporator, and distill-off the isopropyl ether under mild vacuum. When all the ether has been removed, take out the remaining residue, and place into a clean vacuum distillation apparatus. Then distill the sarin-ethyl at 66 to 73 Celsius under a vacuum of 20 millimeters of mercury to obtain a purified sarin-ethyl product. **Note: instead of distilling-off the isopropyl ether, the ether mixture may be used in chemical warfare operations, and is actually preferred as a method of storing, preserving, and protecting the sarin-ethyl from decomposition. Mixtures of sarin-ethyl with ether, or methylene chloride can be effectively used to disseminate the sarin-ethyl in wartime operations. Mixtures of sarin-ethyl in a solvent such as methylene chloride or ether may persist up to two or three times longer than straight sarin-ethyl in wartime operations.**

### Procedure 04-004B: Preparation of Sarin-ethyl (sodium fluoride process)

**Summary:** Sarin-ethyl can be made using a modified process where by sodium fluoride is the fluorinating agent rather than the dangerous to handle hydrofluoric acid. The first step is the preparation of the already discussed ethyl phosphonic dichloride. The second step is the preparation of the difluoride, which is accomplished by refluxing sodium fluoride with half of the ethyl phosphonic dichloride. The resulting difluoride is then mixed with the other half of ethyl phosphonic dichloride, and then treated with isopropyl alcohol. The sarin-ethyl can then be purified using the usual methods. Note: The preparation of ethyl phosphonic dichloride discussed in step 1, is similar or related to the process discussed in serial number 292,390 June 7<sup>th</sup>, 1952 by John P. Clay, assigned by Dugway Proving Grounds. This process may be protected by industrial/commercial process applications. Consult said application number before using the mentioned process for commercial or industrial processes.

Chapter 10: Preparation of Nerve Agents



Reaction equation (by-products omitted)

<b>Materials:</b>	1. 27.4 grams of phosphorus trichloride	6. 2.8 grams of sodium fluoride
	2. 26.6 grams of anhydrous aluminum chloride	7. 4 grams of anhydrous isopropyl alcohol
	3. 38.6 grams of ethyl chloride	8. 30 grams of dry silica gel
	4. 500 milliliters of methylene chloride	9. 200+ milliliters of isopropyl ether
	5. 50.6 milliliters of 35 to 37% hydrochloric acid	10. 100 milliliters of toluene

**Hazards:**



Do not attempt in anyway to prepare sarin-ethyl using the following procedure unless proper safety precautions are taken. 1) Perform all operations in a clean box, which is treated with a nitrogen atmosphere, and in which is completely sealed from the air. 2) After each procedure, all glassware and non-electric equipment should be soaked in a bleach (sodium hypochlorite) solution before removing from the clean box. Any electrical equipment such as hot plates and stirring equipment should be carefully wiped down with a bleached soaked rag before removing from the clean box. 3) After the entire operation is complete, the entire clean box should be disinfected with bleach before opening the clean box to the air. 4) The desired sarin-ethyl product should be stored in amber bottles, preferably non-breakable containers, and stored in a cool dry place away from sunlight. The bottles should also be placed inside an airtight sealed plastic bag, such as a 'ziplock' bag. 5) Storage of any and all nerve agents should be in airtight cabinets, drawers, or the like, and said storage spaces should be equipped with chemical agent detection monitors to alert of any potential leakage.

Use caution when handling ethyl phosphonic dichloride, which is highly toxic, and can be absorbed through the skin causing mild nerve agent symptoms. Use care when handling phosphorus trichloride, and aluminum chloride, both of which can cause irritation of the skin and eyes, and both of which violently react with water evolving corrosive and toxic fumes. Avoid inhalation of toluene vapors, as they are potentially carcinogenic. Wear gloves when handling sodium fluoride, and avoid ingestion and skin absorption. Wear gloves when handling concentrated hydrochloric acid, and avoid inhalation of the vapors.

**Procedure:**

Step 1: Preparation of ethyl phosphonic dichloride



Into a suitable sized flask, place 26.6 grams of anhydrous aluminum chloride (pre-chilled in a freezer at 0 Celsius). Thereafter, add in 27.4 grams of pure phosphorus trichloride (also pre-chilled in a freezer at 0 Celsius), followed by 38.6 grams of anhydrous liquid ethyl chloride (from a lecture bottle, or liquid dispensed from proper container chilled to 0 Celsius). Then securely stopper the bottle, and then place it into a shaking machine (if available), and rapidly shake the flask for 30 minutes until all solids dissolve (note: a slight increase in heat will result). Then place the sealed flask into a refrigerator at 5 Celsius for 24 hours. Note: During the shaking, pressure may build up; so occasional venting may be needed. When venting, just slightly open the flask to avoid excess air from entering the flask. After 24 hours, remove the flask from the refrigerator, and then filter-off the insoluble precipitate. The insoluble precipitate should then be vacuum dried, and then stored in a desiccator filled with inert drying agent such as anhydrous sodium sulfate for 24 hours. The result will be about 36 grams of the aluminum chloride/phosphorus trichloride/ethyl chloride complex. After drying the complex in the desiccator for 24 hours, remove it, and then dissolve it into 400 milliliters of methylene chloride contained in a suitable flask. Then place said flask into an ice bath and chill to 0 Celsius. Thereafter add drop wise, at the rate of about 10 drops per minute, 50.6 milliliters of 35 to 38% hydrochloric acid (pre-chilled to 0 Celsius) while stirring the methylene chloride mixture and maintaining its temperature around 0 Celsius. After the addition, continue to stir the reaction mixture at 0 Celsius for about 90 minutes. After 90 minutes, filter-off any insoluble impurities, and then place the filtered mixture into a separatory funnel, and then remove the upper water layer. Thereafter, place the lower methylene chloride layer into a rotary evaporator, and evaporate off the methylene chloride under mild vacuum. If vacuum apparatus is unavailable, carefully distill-off the methylene chloride at 40 Celsius. After the methylene chloride has been removed, remove the remaining contents, and place into a clean vacuum distillation apparatus, and vacuum distill at 71 Celsius under a vacuum of 12 millimeters of mercury. The result will be about 14 grams of a semi-solid to liquid mass of ethyl phosphonic dichloride.

### Step 2: Preparation of sarin-ethyl

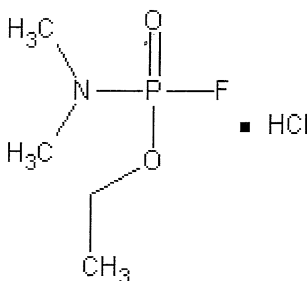
Too 10 grams of the product obtained in step 1, place 5 grams of it into a suitable flask, and then add 100 milliliters of toluene. Thereafter, add 2.8 grams of anhydrous sodium fluoride and then begin rapidly stirring the mixture. Then place the mixture into a reflux apparatus and reflux the mixture at 90 Celsius for 1 hour. After refluxing for 1 hour, remove the heat source, and then allow the reaction mixture to cool to room temperature. Thereafter, filter the reaction mixture to remove any insoluble impurities, and then place the filtered reaction mixture into a rotary evaporator, and evaporate-off the toluene under vacuum. When all the toluene has been removed, remove the remaining residue, and then place said residue into a clean flask, and then add 100 milliliters of methylene chloride, followed by the other 5 grams of the product obtained in step 1. Note: stir the mixture thereafter to dissolve the residue into the methylene chloride. Then add drop wise, 4 grams of anhydrous isopropyl alcohol over a period of about 5 minutes, while stirring the reaction mixture and maintaining the reaction mixtures temperature at room temperature. After the addition of the isopropyl alcohol, continue to stir the reaction mixture for 1 hour at room temperature. Thereafter, reflux the reaction mixture at 60 Celsius for 1 hour while stirring. After the reflux period, remove the heat source and allow the reaction mixture to cool to room temperature. Then filter the reaction mixture to remove any insoluble impurities, and then place the filtered reaction mixture into a rotary evaporator and evaporate-off the methylene chloride under mild vacuum. If vacuum apparatus is unavailable, distill-off the methylene chloride at 40 Celsius. **Note: The methylene chloride mixture can be used directly in chemical warfare operations, when disseminated properly.** When the methylene chloride has been removed, remove the remaining residue and place into a clean vacuum distillation apparatus, and distill the sarin-ethyl at 66 to 73 Celsius under a vacuum of 20 millimeters of mercury to obtain a crude sarin-ethyl product. **Note: this crude sarin-ethyl product need not be purified for use in chemical warfare operations. Purification of the sarin-ethyl is only desired if the sarin-ethyl is to be mixed with other agents.**

### Step 3: Purification of sarin-ethyl

Setup the apparatus displayed in figure 046, thereafter prepare the silica gel with the following process: Pour 200 milliliters of distilled water into a suitable beaker, and then slowly pour in 30 grams of dry silica gel of 50 to 200 mesh while gradually stirring the mixture. After the addition of the silica gel, rapidly stir the mixture for 15 minutes, and thereafter, carefully decant-off the "fines". The fines are particles of matter that need to be removed to ensure a good flow rate. Then pour the silica gel into the glass column (make sure the glass column's stopcock is closed), as pictured in the following figure. Thereafter, pour in distilled water until the glass column is nearly full. Then gently open the stopcock, and drain off most of the water, until only about 10 centimeters of water remains above the silica gel layer. Then add 50 milliliters of dry isopropyl ether into the glass column, and then carefully drain-off the ether until most of it has passed through (by this time most of the water should have been removed). Thereafter, close the stopcock, and then add enough isopropyl ether into the glass column until the glass column is nearly full. Then, gently open the stopcock, and begin a very slow drip of the ether, and then at the same time, pour the crude sarin-ethyl product, obtained in step 2, into the glass column, and allow it to slowly pass through the glass column, drip by drip. Now when the total liquid layer is about 10 centimeters above the silica gel layer, close the stopcock. Immediately thereafter, remove the washing portion from the apparatus (remove the receiver flask at the bottom), and pour the contents into a clean beaker. Then replace said receiver flask with a clean one, and then pour enough fresh isopropyl ether into the glass column until the glass column is nearly full (make sure the stopcock is closed). Then open the stopcock to form a gentle drip, and then immediately add in the ether-washing portion (containing the sarin-ethyl) contained in the beaker into the glass column. Allow most of the ether to drain into the receiver flask. After which, remove the receiver flask from the apparatus, and then

remove any water by placing the mixture into a separatory funnel, and draining off the bottom water layer. After any water has been removed, place the ether mixture into a clean rotary evaporator, and distill-off the isopropyl ether under mild vacuum. When all the ether has been removed, take out the remaining residue, and place into a clean vacuum distillation apparatus. Then distill the sarin-ethyl at 66 to 73 Celsius under a vacuum of 20 millimeters of mercury to obtain a purified sarin-ethyl product. **Note: instead of distilling-off the isopropyl ether, the ether mixture may be used in chemical warfare operations, and is actually preferred as a method of storing, preserving, and protecting the sarin-ethyl from decomposition. Mixtures of sarin-ethyl with ether, or methylene chloride can be effectively used to disseminate the sarin-ethyl in wartime operations. Mixtures of sarin-ethyl in a solvent such as methylene chloride or ether may persist up to two or three times longer than straight sarin-ethyl in wartime operations.**

#### 04-005. FluoroTabun Hydrochloride. FTH. *Dimethylamidoethoxyphosphoryl fluoride-Hydrochloride; N-Dimethylphosphoramidofluoridate-Hydrochloride*



FluoroTabun Hydrochloride

No sufficient data exists on fluorotabun hydrochloride, but it is presumed to be a colorless solid, with a faint fishy odor or a slight almond to chloroform like odor. Absolute pure fluorotabun is probably odorless. It is safe to predict that fluorotabun hydrochloride would be quite stable in water solutions making it much more efficient in military operations during wet and rainy conditions. Its stability in water may be up to 2 weeks under neutral conditions. Alkaline solutions would rapidly decompose fluorotabun hydrochloride. Practical methods of dissemination in wet climates would be from smoke generating compositions. Fluorotabun hydrochloride may be used in "covert" operations due to its low volatility. Such delivery systems in this regard would most likely be "pepper" type spraying devices, aerosols, or smoke grenades. Other, more overlooked reasons for rating this compound "very useful" in the field of chemical warfare is the simple fact that it's a solid, and as such, would be much easier to handle and store. Fluorotabun hydrochloride could be stored for long periods of time without fear or worry of leaks, or similar problems sometimes encountered with typical chemical warfare munitions. The toxicity of fluorotabun hydrochloride is presumed to be less than sarin, tabun, or soman (by inhalation or skin contact), but because of its water solubility and ability to easily be absorbed into the body (through ingestion) its toxicity through ingestion would be quite high. As briefly stated, no data exists on this compound so its unknown if fluorotabun hydrochloride would have any real potential use as a nerve agent. Nevertheless, it is probably safe to say that this compound does have application in the field of military operations, either for training military personnel, use in covert operations, or used in mass quantity on the battle field. Because few chemical warfare agents are solids, large areas of dry vegetation could be contaminated with said substance, and remain a threat to anyone who may brush a tree limb, sit down, or happen to have his or her skin come in contact with the aforementioned agent. Note: This substance may demonstrate excellent results in military operations when admixed with other nerve agents such as sarin, tabun, soman, or with the nitrogen mustards. **Fluorotabun hydrochloride is a potentially delayed action casualty agent capable of producing casualties within 1 to 36 hours after dissemination or exposure by personnel. Any personnel exposed to this agent may become incapacitated within minutes of contact, or after a delay period of up to 36 hours. The lethal dose, through ingestion is probably 2 to 28 milligrams per average man. The lethal dose per person through inhalation is probably 1 to 8 milligrams. Fluorotabun hydrochloride is highly toxic through ingestion, inhalation, and skin and eye absorption.**

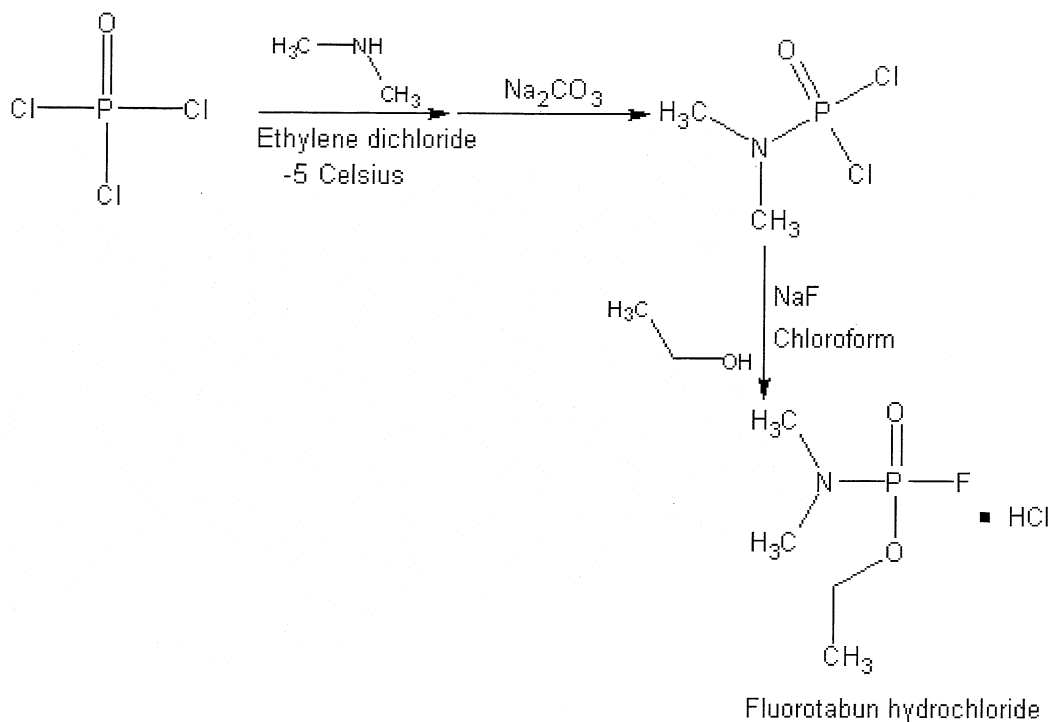
OVERALL RATING (scale from 1 to 10)	
<i>Effectiveness (as nerve agent): 6</i>	<i>Field Stability: 7</i>
<i>Persistence (open area): 9</i>	<i>Storage stability: 10</i>
<i>Persistence (enclosed area): 9</i>	<i>Toxicity (as nerve agent): 6½</i>
<b>TOTAL EFFECTIVENESS (as nerve agent): 7.9</b>	
<b>OVERALL TOXICITY (as warfare agent): 6</b>	

#### Procedure 04-005A: Preparation of FluoroTabun Hydrochloride

## Chapter 10: Preparation of Nerve Agents

**Summary:** Fluorotabun hydrochloride is readily prepared using a two-step process starting with the preparation of dimethylamido phosphoryl dichloride. The dichloride intermediate is prepared by reacting dimethylamine with phosphorus oxytrichloride in ethylene dichloride solvent. The resulting amine hydrochloride salt is then simultaneously decomposed to the diethylamido phosphoryl dichloride by the addition of sodium carbonate. The dimethylamido phosphoryl dichloride is then converted into fluorotabun hydrochloride by reaction with sodium fluoride and ethyl alcohol in the presence of chloroform. The resulting reaction mixture is then refluxed, filtered, and then stripped of solvent, and the remaining residue stirred with petroleum ether to obtain a crystalline product.

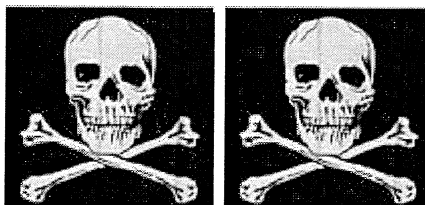
**Note:** The preparation of dimethylamido phosphoryl dichloride discussed in step 1, is similar or related to the process discussed in serial number 281,886 April 11<sup>th</sup>, 1952 by George A. Saul and Kenneth L. Godfrey, both of Virginia, assigned by Monsanto Chemical Company. This process may be protected by industrial/commercial process applications. Consult said application number before using the mentioned process for commercial or industrial purposes. Second note: The process discussed in step 2, is protected by Jared B. Ledgard, who subsequently is the inventor of said process. Please consult Jared B. Ledgard before using said process for commercial or industrial use.



### Reaction Equation (by-products omitted)

<b>Materials:</b>	1. 153.5 grams of phosphorus oxytrichloride	5. 5.1 grams of anhydrous sodium fluoride
	2. 600 grams of ethylene dichloride	6. 5.7 grams 95% ethyl alcohol
	3. 49.5 grams of anhydrous dimethylamine (lecture bottle)	7. 350 milliliters of chloroform
	4. 63.5 grams of anhydrous sodium carbonate	8. 50 milliliters of petroleum ether

### Hazards:



**WARNING! WARNING!**

Do not attempt in anyway to prepare fluorotabun hydrochloride using the following procedure unless proper safety precautions are taken. 1) Perform all operations in a clean box, which is treated with a nitrogen atmosphere, and in which is completely sealed from the air. 2) After each procedure, all glassware and non-electric equipment should be soaked in a bleach (sodium hypochlorite) solution before removing from the clean box. Any electrical equipment such as hot plates and stirring equipment should be carefully wiped down with a bleached soaked rag before removing from the clean box. 3) After the entire operation is complete, the entire clean box should be disinfected with bleach before

## Chapter 10: Preparation of Nerve Agents

opening the clean box to the air. 4) The desired fluorotabun hydrochloride product should be stored in amber bottles, preferably non-breakable containers, and stored in a cool dry place away from sunlight. The bottles should also be placed inside an airtight sealed plastic bag, such as a 'ziplock' bag. 5) Storage of any and all nerve agents should be in airtight cabinets, drawers, or the like, and said storage spaces should be equipped with chemical agent detection monitors to alert of any potential leakage.

Use caution when handling dimethylamido phosphoryl dichloride, which may cause nerve agent like symptoms if ingested or inhaled. Wear gloves when handling sodium fluoride, which is very poisonous and can be absorbed through the skin. Wear gloves when handling acetonitrile, which can be absorbed by the skin leading to toxic results. Ethanol and petroleum ether are flammable, so extinguish all flames before using. Use care when handling dimethylamine, which is an irritant. Use care when handling chloroform.

### Procedure:

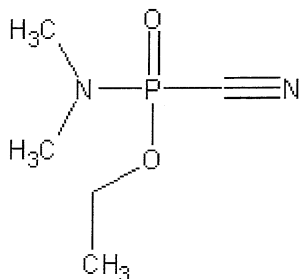
#### Step 1: Preparation of dimethylamido phosphoryl dichloride

Into a suitable flask, place 153.5 grams of phosphorus oxytrichloride, and then 500 grams of ethylene dichloride. Thereafter, place the mixture into a salt/ice bath, and chill to  $-5$  Celsius. When the temperature of the mixture reaches  $-5$  Celsius, slowly bubble into the mixture, 49.5 grams of dry dimethylamine while stirring the reaction mixture and maintaining its temperature at  $-5$  Celsius. After the addition of the dimethylamine, add in 63.5 grams of anhydrous and powdered sodium carbonate. During the addition, stir the reaction mixture, and maintain its temperature at  $-5$  Celsius. After the addition of the sodium carbonate, continue to stir the reaction for 30 minutes at  $-5$  Celsius. Thereafter, filter-off any insoluble impurities, and then wash these filtered-off impurities several times with a single washing portion of ethylene dichloride (100 grams). After the washing, combine the 100-gram portion of ethylene dichloride with the filtered reaction mixture, and then place the reaction mixture into a rotary evaporator or vacuum distillation apparatus, and remove the ethylene dichloride solvent under vacuum. After the ethylene dichloride solvent has been removed, place the remaining residue into a clean vacuum distillation apparatus, and fractionally distill the product at 90 Celsius under a vacuum of 22 millimeters of mercury to obtain a good yield of dimethylamido phosphoryl dichloride.

#### Step 2: Preparation of fluorotabun hydrochloride

Into a suitable flask, add 350 milliliters of chloroform, and then add and dissolve 20 grams of the product obtained in step 1. Thereafter, prepare a solution by adding and dissolving 5.1 grams of anhydrous sodium fluoride, and 5.7 grams of 95% ethyl alcohol into 10 milliliters of ice cold water. Then place the chloroform mixture into a cold-water bath, and chill to 10 Celsius. When the temperature reaches 10 Celsius, slowly add drop-wise, the sodium fluoride/ethyl alcohol solution to the chloroform mixture over a sufficient time as to keep the reaction mixtures temperature below 15 Celsius. During the addition, vigorously stir the reaction mixture. After the addition, vigorously stir the reaction mixture for 1 hour at 10 Celsius. Then remove the reaction mixture from the cold water bath, and then remove the upper water layer using a separatory funnel, or by decantation. Note: Do not filter-off any insoluble materials. Thereafter, reflux the lower chloroform mixture at 60 Celsius for 30 minutes. After 30 minutes, quickly remove the flask from the reflux apparatus, and then quickly filter the hot reaction mixture to remove any insoluble materials (discard these solids). Then allow the filtered reaction mixture to cool to room temperature. Note: if any solids precipitate at this point, filter them off using a clean filter, and keep the solids for later. Then place the reaction mixture into a rotary evaporator or vacuum distillation apparatus, and remove the chloroform solvent under vacuum. When all the chloroform has been removed, remove the remaining residue (and combine with any previously filtered-off solids), and then place all the solids (residue) into a clean flask, and then add 50 milliliters of petroleum ether. Then stir the mixture for several minutes at room temperature. Thereafter, filter-off the insoluble fluorotabun hydrochloride, and then vacuum dry or air dry.

### 04-006. Tabun. GA. *Dimethylamidoethoxyphosphoryl cyanide; N-Dimethylphosphoramidocyanidate*



Tabun

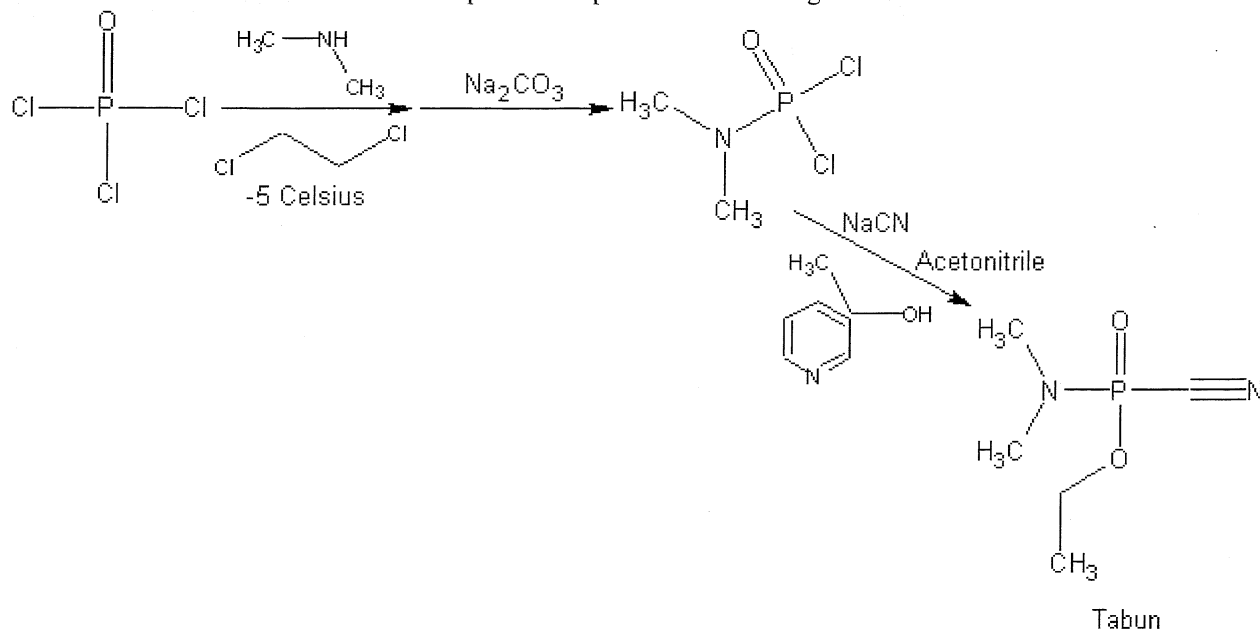
Tabun forms a colorless liquid, which is brown to amber in color when impure. It has no odor when pure, but has a slight almond to fruity odor when impure. It has a melting point of  $-50$  Celsius, and a boiling point of  $240$  Celsius (with decomposition). Tabun can be distilled at  $110$  Celsius under a vacuum of  $9$  millimeters of mercury. It is readily soluble in the usual organic solvents, and in water. Its solubility in water leads rise to hydrolysis, and it's decomposed by water at room temperature in about  $24$  hours. It is also decomposed rapidly by strong bases (alkalies), yielding the deadly poison, hydrogen cyanide, and the non-toxic products of ethanol and dimethylamido phosphoric acid. The half-life of tabun is  $97$  minutes at  $150$  Celsius. Tabun will persist for about  $24$  to  $48$  hours under normal environmental conditions. It takes  $20$  times longer than water to evaporate, meaning its volatility is relatively low, but under dry and cool conditions its persistence is quite satisfactory. Tabun is very effective when used within enclosed environments, such as tunnels, rooms, bunkers, and the like; especially under dry and cool conditions. One interesting fact about tabun is the difficulty in proper decontamination. The usual military decontamination kits do not effectively decontaminate contaminated equipment or areas containing tabun, because tabun gives rise to cyanogen chloride when treated with bleach or bleaching powder, or the deadly hydrogen cyanide when treated with alkalies. In open areas, decontamination with the usual kits is acceptable due to the very high volatility and dissipation rate of cyanogen chloride or hydrogen cyanide, but within enclosed environments, the cyanogen chloride, or hydrogen cyanide may linger for long periods of time causing a secondary "gas attack". Environments contaminated with tabun will most likely be "left along" by passing troops due to the pains involved in decontamination; as a result, tabun finds its most important military use as a "road block" purse, temporally diverting advancing troops. It may take up to  $48$  to  $72$  hours for tabun-contaminated areas to reach safe levels. Tabun can be efficiently disseminated through aerosols, explosives munitions, atomizers or humidifiers, or foggers. **Tabun is a fast acting causality producing agent capable of causing casualties within minutes of dissemination. Toxicity: Lethal dose 50% of population i.p. in mice: 0.60 milligrams per kilogram of body weight. The lethal dose for the average man is about 0.010 milligrams per kilogram (800 micrograms lethal dose for man of 180 pounds of weight). When used properly, 4 milligrams of tabun may kill 5 soldiers. Personnel exposed to non-lethal amounts of the agent may still become incapacitated within 10 minutes of exposure, and will become unable to perform their normal duties as soldiers. Those personnel exposed to lethal doses will be dead within 60 minutes. Note: Tabun is more effective in wartime operations than sarin, and is preferred 3 to1 over sarin in military operations. Tabun is highly toxic through ingestion, inhalation, and skin and eye absorption.**

OVERALL RATING (scale from 1 to 10)	
<i>Effectiveness (as nerve agent): 8</i>	<i>Field Stability: 7</i>
<i>Persistence (open area): 7</i>	<i>Storage stability: 9</i>
<i>Persistence (enclosed area): 8</i>	<i>Toxicity (as nerve agent): 7</i>
<b>TOTAL EFFECTIVENESS (as nerve agent): 7.6</b>	
<b>OVERALL TOXICITY (as warfare agent): 7½</b>	

### Procedure 04-006A: Preparation of Tabun (preferred process)

**Summary:** Tabun is readily prepared using a two-step process starting with the preparation of dimethylamido phosphoryl dichloride. The dichloride intermediate is prepared by reacting dimethylamine with phosphorus oxytrichloride in ethylene dichloride solvent. The resulting amine hydrochloride salt is then simultaneously decomposed to the diemethylamido phosphoryl dichloride by the addition of sodium carbonate. The dimethylamido phosphoryl dichloride is then converted into tabun by reaction with sodium cyanide and ethyl alcohol in acetonitrile in the presence of pyridine. The pyridine is used as an acid scavenger, removing the hydrogen chloride. The resulting reaction mixture is then filtered, stripped of solvent, and the remaining residue distilled to obtain refined tabun. Note: The preparation of dimethylamido phosphoryl dichloride discussed in step 1, is similar or related to the process discussed in serial number 281,886 April 11<sup>th</sup>, 1952 by George A. Saul and Kenneth L. Godfrey, both of Virginia, assigned by Monsanto Chemical Company. This process may be protected by industrial/commercial process applications. Consult said application number before using the mentioned process for commercial or industrial purposes.

Chapter 10: Preparation of Nerve Agents



*Reaction Equation (by product omitted)*

<b>Materials:</b>	1. 153.5 grams of phosphorus oxytrichloride	5. 6 grams of anhydrous sodium cyanide
	2. 780 grams of ethylene dichloride	6. 5.6 grams anhydrous ethyl alcohol (200 proof)
	3. 49.5 grams of anhydrous dimethylamine (lecture bottle)	7. 60 milliliters of acetonitrile
	4. 63.5 grams of anhydrous sodium carbonate	8. 10 grams of pyridine

**Hazards:**



**WARNING! WARNING! WARNING!**

Do not attempt in anyway to prepare tabun using the following procedure unless proper safety precautions are taken. 1) Perform all operations in a clean box, which is treated with a nitrogen atmosphere, and in which is completely sealed from the air. 2) After each procedure, all glassware and non-electric equipment should be soaked in a bleach (sodium hypochlorite) solution before removing from the clean box. Any electrical equipment such as hot plates and stirring equipment should be carefully wiped down with a bleached soaked rag before removing from the clean box. 3) After the entire operation is complete, the entire clean box should be disinfected with bleach before opening the clean box to the air. 4) The desired tabun product should be stored in amber bottles, preferably non-breakable containers, and stored in a cool dry place away from sunlight. The bottles should also be placed inside an airtight sealed plastic bag, such as a 'ziplock' bag. 5) Storage of any and all nerve agents should be in airtight cabinets, drawers, or the like, and said storage spaces should be equipped with chemical agent detection monitors to alert of any potential leakage. Use caution when handling dimethylamido phosphoryl dichloride, which may cause nerve agent like symptoms if ingested or inhaled. Wear gloves when handling sodium cyanide, and acetonitrile, both of which can be absorbed by the skin leading to toxic results. Ethanol is flammable, so extinguish all flames before using. Use care when handling dimethylamine, which is an irritant.

**Procedure:**

**Step 1: Preparation of dimethylamido phosphoryl dichloride**

Into a suitable flask, place 153.5 grams of phosphorus oxytrichloride, and then 500 grams of ethylene dichloride. Thereafter, place the mixture into a salt/ice bath, and chill to -5 Celsius. When the temperature of mixture reaches -5 Celsius, slowly bubble into the mixture, 49.5 grams of dry dimethylamine while stirring the reaction mixture and maintaining its temperature at -5 Celsius. After the

## Chapter 10: Preparation of Nerve Agents

addition of the dimethylamine, add in 63.5 grams of anhydrous and powdered sodium carbonate. During the addition, stir the reaction mixture, and maintain its temperature at  $-5$  Celsius. After the addition of the sodium carbonate, continue to stir the reaction mixture for 30 minutes at  $-5$  Celsius. Thereafter, filter-off any insoluble impurities, and then wash these filtered-off impurities several times with a single washing portion of ethylene dichloride (100 grams). After the washing, combine the 100-gram portion of ethylene dichloride with the filtered reaction mixture, and then place the reaction mixture into rotary evaporator or vacuum distillation apparatus, and remove the ethylene dichloride solvent under vacuum. After the ethylene dichloride solvent has been removed, place the remaining residue into a clean vacuum distillation apparatus, and fractionally distill the product at 90 Celsius under a vacuum of 22 millimeters of mercury to obtain a good yield of dimethylamido phosphoryl dichloride.

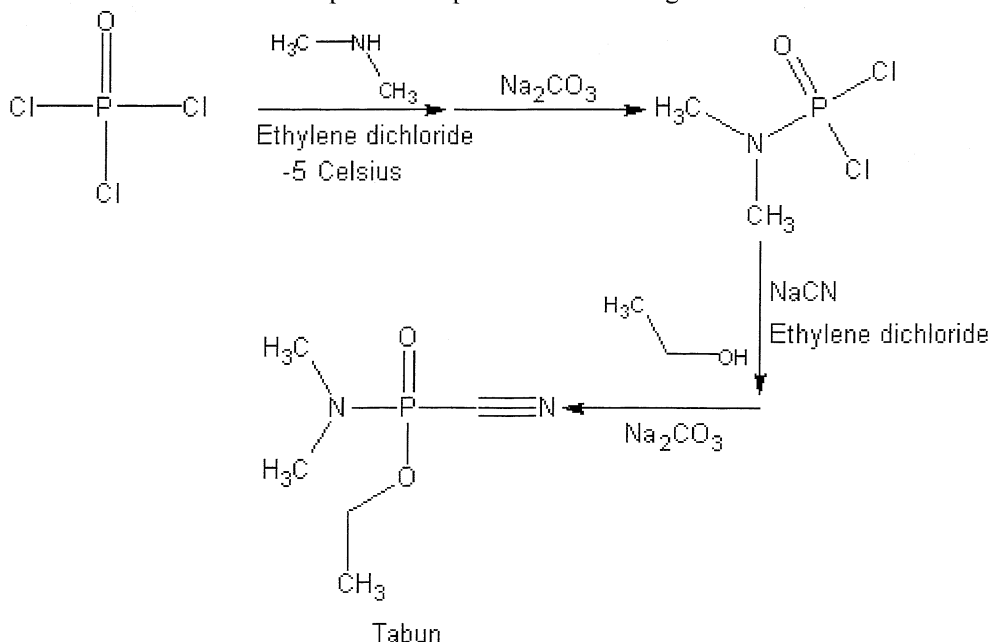
### Step 2: Preparation of tabun

Into a suitable flask, add 180 grams of ethylene dichloride, and then 20 grams of the product obtained in step 1. Thereafter, thoroughly blend the mixture to dissolve all solids. Then prepare a solution by adding and dissolving 6 grams of finely powdered anhydrous sodium cyanide, and then 10 grams of pyridine into 60 milliliters of acetonitrile, and thereafter, add and dissolve 5.6 grams of anhydrous ethyl alcohol there into. Then place the flask containing the ethylene dichloride mixture into an ice bath, and chill to 0 Celsius. Thereafter, slowly add drop-wise, the sodium cyanide/acetonitrile/pyridine/ethyl alcohol solution, to the ethylene dichloride mixture while vigorously stirring the ethylene dichloride mixture and keeping its temperature around 0 Celsius. After the addition, continue to vigorously stir the reaction mixture for 1 hour at 0 Celsius, after which, remove the ice bath, and then reflux the entire reaction mixture for 90 minutes at 84 Celsius with vigorous stirring. After 90 minutes, remove the heat source, and allow the reaction mixture to cool to room temperature. Thereafter, filter-off any insoluble solids, and then place the filtered reaction mixture into a rotary evaporator, or vacuum distillation apparatus, and remove the ethylene dichloride solvent, and acetonitrile solvent under vacuum. Note: These two solvents can be collected in the same receiver flask, and separated later, or fractionally distilled using two different angled liebig condensers. After the ethylene dichloride and acetonitrile solvents have been removed, remove the remaining residue, and place into a clean vacuum distillation apparatus, and fractionally distill the tabun at 110 Celsius under a vacuum of 9 millimeters of mercury to obtain a refined tabun product. Purification can be accomplished by using a silica gel column filled with aluminum oxide, and using methylene chloride solvent. **Note: The refined tabun product can be dissolved in methylene chloride, ether, or any desired solvent, and used as such in chemical warfare operations when properly disseminated.**

### Procedure 04-006B: Preparation of Tabun

**Summary:** Tabun is readily prepared using a two-step process starting with the preparation of dimethylamido phosphoryl dichloride. The dichloride intermediate is prepared by reacting dimethylamine with phosphorus oxytrichloride in ethylene dichloride solvent. The resulting amine hydrochloride salt is then simultaneously decomposed to the diemethylamido phosphoryl dichloride by the addition of sodium carbonate. The dimethylamido phosphoryl dichloride is then converted into tabun by reaction with sodium cyanide and ethyl alcohol in acetonitrile, followed by neutralization of the amine salt with sodium carbonate. The resulting reaction mixture is then stripped of solvent, and the remaining residue distilled to obtain refined tabun. Note: The preparation of dimethylamido phosphoryl dichloride discussed in step 1, is similar or related to the process discussed in serial number 281,886 April 11<sup>th</sup>, 1952 by George A. Saul and Kenneth L. Godfrey, both of Virginia, assigned by Monsanto Chemical Company. This process may be protected by industrial/commercial process applications. Consult said application number before using the mentioned process for commercial or industrial purposes.

Chapter 10: Preparation of Nerve Agents



*Reaction Equation (by-products omitted)*

<b>Materials:</b>	1. 153.5 grams of phosphorus oxytrichloride	5. 6 grams of anhydrous sodium cyanide
	2. 780 grams of ethylene dichloride	6. 5.6 grams anhydrous ethyl alcohol (200 proof)
	3. 49.5 grams of anhydrous dimethylamine (lecture bottle)	7. 60 milliliters of acetonitrile
	4. 69.5 grams of anhydrous sodium carbonate	

**Hazards:**



Do not attempt in anyway to prepare tabun using the following procedure unless proper safety precautions are taken. 1) Perform all operations in a clean box, which is treated with a nitrogen atmosphere, and in which is completely sealed from the air. 2) After each procedure, all glassware and non-electric equipment should be soaked in a bleach (sodium hypochlorite) solution before removing from the clean box. Any electrical equipment such as hot plates and stirring equipment should be carefully wiped down with a bleached soaked rag before removing from the clean box. 3) After the entire operation is complete, the entire clean box should be disinfected with bleach before opening the clean box to the air. 4) The desired tabun product should be stored in amber bottles, preferably non-breakable containers, and stored in a cool dry place away from sunlight. The bottles should also be placed inside an airtight sealed plastic bag, such as a 'ziplock' bag. 5) Storage of any and all nerve agents should be in airtight cabinets, drawers, or the like, and said storage spaces should be equipped with chemical agent detection monitors to alert of any potential leakage. Use caution when handling dimethylamido phosphoryl dichloride, which may cause nerve agent like symptoms if ingested or inhaled. Wear gloves when handling sodium cyanide, and acetonitrile, both of which can be absorbed by the skin leading to toxic results. Ethanol is flammable, so extinguish all flames before using. Use care when handling dimethylamine, which is an irritant.

**Procedure:**

Step 1: Preparation of dimethylamido phosphoryl dichloride

Into a suitable flask, place 153.5 grams of phosphorus oxytrichloride, and then 500 grams of ethylene dichloride. Thereafter, place the mixture into a salt/ice bath, and chill to -5 Celsius. When the temperature of mixture reaches -5 Celsius, slowly bubble into the

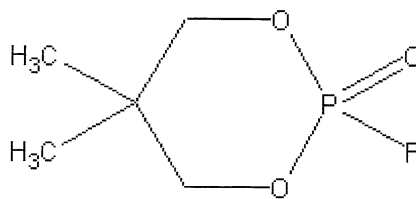


mixture, 49.5 grams of dry dimethylamine while stirring the reaction mixture and maintaining its temperature at  $-5$  Celsius. After the addition of the dimethylamine, add in 63.5 grams of anhydrous and powdered sodium carbonate. During the addition, stir the reaction mixture, and maintain its temperature at  $-5$  Celsius. After the addition of the sodium carbonate, continue to stir the reaction mixture for 30 minutes at  $-5$  Celsius. Thereafter, filter-off any insoluble impurities, and then wash these filtered-off impurities several times with a single washing portion of ethylene dichloride (100 grams). After the washing, combine the 100-gram portion of ethylene dichloride with the filtered reaction mixture, and then place the reaction mixture into rotary evaporator or vacuum distillation apparatus, and remove the ethylene dichloride solvent under vacuum. After the ethylene dichloride solvent has been removed, place the remaining residue into a clean vacuum distillation apparatus, and fractionally distill the product at 90 Celsius under a vacuum of 22 millimeters of mercury to obtain a good yield of dimethylamido phosphoryl dichloride.

#### Step 2: Preparation of tabun

Into a suitable flask, add 180 grams of ethylene dichloride, and then 20 grams of the product obtained in step 1. Thereafter, thoroughly blend the mixture to dissolve all solids. Then prepare a solution by adding and dissolving 6 grams of finely powdered anhydrous sodium cyanide into 60 milliliters of acetonitrile, and thereafter, add and dissolve 5.6 grams of anhydrous ethyl alcohol there into. Then place the flask containing the ethylene dichloride mixture into an ice bath, and chill to 0 Celsius. Thereafter, slowly add dropwise, the sodium cyanide/acetonitrile/ethyl alcohol solution, to the ethylene dichloride mixture while vigorously stirring the ethylene dichloride mixture and keeping its temperature around 0 Celsius. After the addition, continue to vigorously stir the reaction mixture for 1 hour at 0 Celsius, after which, remove the ice bath, and then reflux the entire reaction mixture for 90 minutes at 84 Celsius with vigorous stirring. After 90 minutes, remove the heat source, and allow the reaction mixture to cool to room temperature. Then place the reaction mixture into an ice water bath, and chill to 5 Celsius. Then gradually add in portions, 6 grams of anhydrous powdered sodium carbonate to the reaction mixture, and then vigorously stir the reaction mixture at room temperature for 30 minutes. Afterwards, filter-off any insoluble impurities, and then place the reaction mixture into a rotary evaporator, or vacuum distillation apparatus, and remove the ethylene dichloride solvent, and acetonitrile solvent under vacuum. Note: These two solvents can be collected in the same receiver flask, and separated later, or fractionally distilled using two different angled liebig condensers. After the ethylene dichloride and acetonitrile solvents have been removed, remove the remaining residue, and place into a clean vacuum distillation apparatus, and fractionally distill the tabun at 110 Celsius under a vacuum of 9 millimeters of mercury to obtain a refined tabun product. Purification can be accomplished by using a silica gel column filled with aluminum oxide, and using methylene chloride solvent. **Note: The refined tabun product can be dissolved in methylene chloride, ether, or any desired solvent, and used as such in chemical warfare operations when properly disseminated.**

#### 04-007. NPF. Neopentylene phosphoryl fluoridate; *Neopentylene fluorophosphate*



NPF

NPF is a colorless to light brown or yellowish liquid with a boiling point of 167 Celsius at 760 millimeters of mercury. It may begin to decompose when heated above 130 Celsius, but can be distilled at 69 Celsius under a vacuum of 25 millimeters of mercury. Impure NPF may be a viscous semi-solid liquid. Pure NPF is probably odorless, but as with other nerve agents it probably has a slight odor of hay or fruit when impure. It is only slightly soluble in water (146 grams per liter), but is very soluble in the usual organic solvents. The toxicity of NPF is relatively low, compared to other nerve agents, but its environmental persistence is very good. It can probably remain in the environment for up to 7 days or more, depending on conditions, and has found to be very effective when admixed with other agents such as sarin, or soman. Since the stability of NPF is greater than sarin, soman, or tabun, its effectiveness in military operations is quite high especially when mixed with sarin, or soman. Another potential use for NPF is as an additive with blister agents of the nitrogen mustard class. In cocktails with nitrogen mustards, NPF can demonstrate extremely effective battlefield use. Mixtures of NPF with nitrogen mustards can contaminate tactical areas for up to 4 to 9 days. Any exposed personnel to such contaminated areas may suffer from dangerous nerve agent effects days or even weeks after contact with said environments. This delayed effect is the result of the exposed personnel coming into contact with said blister agents, which cause delayed illness. During this delayed entry of illness, the NPF nerve agent is undergoing its process of body penetration. After body penetration, the exposed personnel can suffer from a numerous array of illnesses for periods of months to even years after exposure. NPF can be disseminated using aerosols, explosives munitions, atomizers or humidifiers, or foggers. **NPF is a mild, delayed action casualty producing nerve agent, capable of producing casualties within 48 hours of dissemination or exposure by personnel. Effects of exposure may not be recognized until days after exposure. The lethal dose for the average man is probably relatively high, anywhere from 2000**

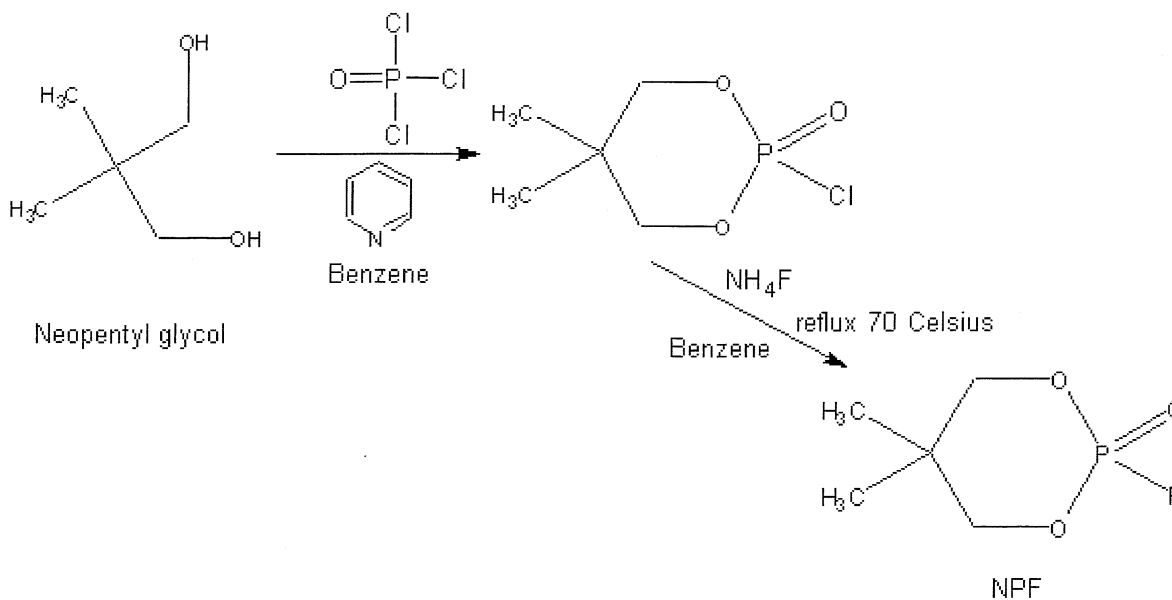
Chapter 10: Preparation of Nerve Agents

micrograms to 10,000 micrograms through inhalation, but the incapacitating effects of this agent, although delayed, may inflict illness to those contaminated for month's even years after exposure. Incapacitation doses may range from 900 to 1200 micrograms per person. Note: This agent can be used as an effective insecticide when diluted with water to a concentration of 0.125% by weight solution of said agent. Note: This agent might actually be available in certain commercial insecticide or pesticide products.

OVERALL RATING (scale from 1 to 10)	
Effectiveness (as nerve agent): 5	Field Stability: 9
Persistence (open area): 9	Storage stability: 8
Persistence (enclosed area): 9	Toxicity (as nerve agent): 5
TOTAL EFFECTIVENESS (as nerve agent): 7.5	
OVERALL TOXICITY (as warfare agent): 5¼	

**Procedure 04-007A: Preparation of NPF**

**Summary:** NPF can be made in a simple two-step process starting with the formation of neopentylene chlorophosphate. This chlorophosphate intermediate is simply prepared by reacting phosphorus oxytrichloride with neopentyl glycol in the presence of benzene. Pyridine is added along with the neopentyl glycol to act as a hydrogen chloride scavenger. The resulting reaction mixture is then stirred for 12 hours, filtered, to remove the insoluble pyridine hydrochloride (which can be recycled by mixing with sodium carbonate), and then evaporated to yield a dry solid. The dry solid is then recrystallized from hot petroleum ether. The resulting neopentylene chlorophosphate is then converted into NPF by reaction with anhydrous ammonium fluoride in benzene under reflux conditions. The resulting reaction mixture is then refluxed for additional time, and then stirred overnight. The resulting mixture is then filtered, evaporated, and then distilled to obtain the refined NPF product. Note: The preparation of neopentylene chlorophosphate discussed in step 1, is similar or related to the process discussed in serial number 274,336, April 19<sup>th</sup>, 1963 by Marcel A. Gradsten, of Demarest, NJ, assigned by Mesne assignments to Tenneco Chemicals, Inc. This process may be protected by industrial/commercial process applications. Consult said application number before using the mentioned process for commercial or industrial purposes.



*Reaction Equation (by products omitted)*

<b>Materials:</b>	1. 76.89 grams of phosphorus oxytrichloride	4. 79 grams of pyridine
	2. 710 milliliters of benzene	5. 200 milliliters of petroleum ether
	3. 52 grams of neopentyl glycol	6. 20 grams of anhydrous ammonium fluoride

**Hazards:**



Do not attempt in anyway to prepare NPF using the following procedure unless proper safety precautions are taken. 1) Perform all operations in a clean box, which is treated with a nitrogen atmosphere, and in which is completely sealed from the air. 2) After each procedure, all glassware and non-electric equipment should be soaked in a bleach (sodium hypochlorite) solution before removing from the clean box. Any electrical equipment such as hot plates and stirring equipment should be carefully wiped down with a bleached soaked rag before removing from the clean box. 3) After the entire operation is complete, the entire clean box should be disinfected with bleach before opening the clean box to the air. 4) The desired NPF product should be stored in amber bottles, preferably non-breakable containers, and stored in a cool dry place away from sunlight. The bottles should also be placed inside an airtight sealed plastic bag, such as a 'ziplock' bag. 5) Storage of any and all nerve agents should be in airtight cabinets, drawers, or the like, and said storage spaces should be equipped with chemical agent detection monitors to alert of any potential leakage. Use caution when handling neopentylene chlorophosphate, which is highly toxic and can be absorbed through the skin. Use caution when handling phosphorus oxytrichloride, which reacts with water producing toxic fumes. Benzene is a suspected carcinogen, so handle with care.

#### Procedure:

##### Step 1: Preparation of neopentylene chlorophosphate

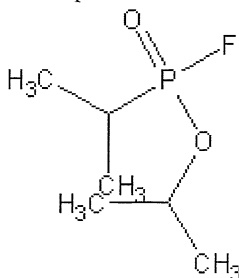
Into a suitable flask, place 76.89 grams of phosphorus oxytrichloride, followed by 350 milliliters of benzene. Thereafter, place this mixture into a cold-water bath, and chill to 10 to 13 Celsius. Thereafter, slowly add, drop wise, over a period of about 45 minutes, a solution prepared by adding and dissolving 52 grams of neopentyl glycol, and 79 grams of pyridine into 100 milliliters of benzene. During the addition, vigorously stir the reaction mixture and maintain its temperature around 10 to 13 Celsius. After the addition, remove the cold-water bath, and allow the reaction mixture to warm to room temperature. Thereafter, continue to stir the reaction mixture for 12 hours at room temperature. After 12 hours, filter-off any insoluble materials, and then wash the filtered-off materials with one 50 milliliter portion of benzene (using the same washing portion), and then wash the filtered-off materials once with a 25 milliliter portion of benzene. Then add the 50-milliliter and 25 milliliter washing portions of benzene to the reaction mixture, and then place the total reaction mixture into a rotary evaporator or vacuum distillation apparatus, and remove the toluene under vacuum. After the benzene is removed, a solid will remain. Then take this solid, and then dissolve it into 200 milliliters of hot petroleum ether. After which, a small amount of an oily residue may form; if an oily residue does form, remove it by decantation, and then allow the hot petroleum ether solution to cool to room temperature. Then place the petroleum ether mixture into an ice bath, and allow it to stand for several hours. Thereafter, filter-off the precipitated product, wash with the cold petroleum ether liquid, and then vacuum dry or air-dry the product. The remaining petroleum ether can be evaporated to yield a few grams more of additional product, which can then be recovered and dried.

##### Step 2: Preparation of NPF

Into a suitable flask, add 50 grams of the product obtained in step 1, and then add 50 milliliters of benzene. Then stir the mixture to dissolve all solids. Then prepare a solution by adding and dissolving 20 grams of anhydrous ammonium fluoride into 135 milliliters of benzene. Then place this ammonium fluoride mixture into a reflux apparatus, and begin refluxing at 70 Celsius with stirring. When the temperature of the ammonium fluoride mixture reaches 70 Celsius, slowly add drop wise, the benzene solution containing the product obtained in step 1 over a period of about 20 minutes while stirring the reaction mixture and maintaining its temperature under reflux at 70 Celsius. After the addition, continue to stir the reaction mixture for 2 hours at 70 Celsius with constant stirring. After stirring for 2 hours, remove the heat source, and allow the reaction mixture to cool to room temperature, and then allow the reaction mixture to stand at room temperature for 12 hours. 12 hours later, filter-off any insoluble impurities, and then place the filtered reaction mixture into a rotary evaporator or vacuum distillation apparatus, and remove the benzene solvent at 60 Celsius under vacuum. After the benzene has been removed, remove the remaining residue, and then place into a clean vacuum distillation apparatus, and distill the product at 69 Celsius under a vacuum of 25 millimeters of mercury to obtain a refined NPF product.

**04-008. Sarin-isopropyl. GBI. Sarin-III. Isopropyl-2-propylphosphonofluoridate;**  
*Isopropoxy-2-propylphosphoryl fluoride;*

Chapter 10: Preparation of Nerve Agents



Sarin-isopropyl

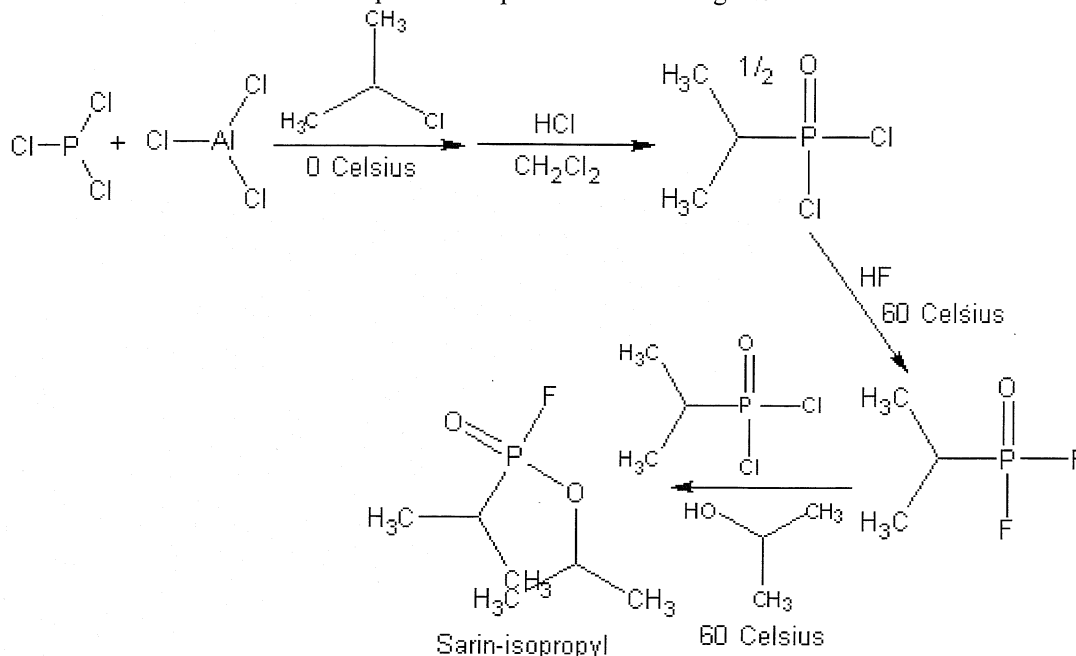
Sarin-isopropyl forms a colorless to lightly colored liquid with a boiling point of 185 Celsius at 760 millimeters of mercury. It begins to decompose when heated above 150 Celsius, but it can be distilled at 87 Celsius under a vacuum of 30 millimeters of mercury. It is only slightly soluble in water (42 grams per liter), but is very soluble in the usual organic solvents. It has similar physical properties to sarin, and similar environmental persistence. Little information exists on sarin-isopropyl, so toxicity data is limited, but it is logical to assume that it's probably related to sarin. It can be disseminated using aerosols, explosives munitions, atomizers or humidifiers, or foggers. **Sarin-isopropyl is a fast acting casualty producing agent capable of causing casualties within minutes of dissemination. The lethal dose for the average man is probably in the neighborhood of 1 to 5 milligrams (by inhalation). Sarin-isopropyl is highly toxic through ingestion, inhalation, and skin and eye absorption.**

OVERALL RATING (scale from 1 to 10)	
<i>Effectiveness (as nerve agent): 8</i>	<i>Field Stability: 8</i>
<i>Persistence (open area): 7</i>	<i>Storage stability: 8</i>
<i>Persistence (enclosed area): 8</i>	<i>Toxicity (as nerve agent): 7¾</i>
<b>TOTAL EFFECTIVENESS (as nerve agent): 7.7</b>	
<b>OVERALL TOXICITY (as warfare agent): 7½</b>	

**Procedure 04-008A: Preparation of Sarin-isopropyl**

**Summary:** Sarin-isopropyl is prepared in an identical way as for ordinary sarin. Sarin-isopropyl is easily prepared using a convenient three-step process, starting with the preparation of isopropyl phosphonic dichloride. The isopropyl phosphonic dichloride is easily made by reacting isopropyl chloride, and phosphorus trichloride in the presence of anhydrous aluminum chloride to form an insoluble complex. This insoluble complex is then recovered by filtration, dissolved in suitable solvent, and then hydrolyzed with concentrated hydrochloric acid. The hydrolyzed product is the isopropyl phosphonic dichloride. Half this product is then treated with hydrofluoric acid to produce isopropyl phosphonic difluoride. The difluoride intermediate is then treated with the other half of isopropyl phosphonic dichloride, and the mixture then treated with isopropyl alcohol. Step 3 is the purification process, which utilizes the standard silica gel column method. Note: The preparation of isopropyl phosphonic dichloride discussed in step 1, is similar or related to the process discussed in serial number 292,390 June 7<sup>th</sup>, 1952 by John P. Clay, assigned by Dugway Proving Grounds. This process may be protected by industrial/commercial process applications. Consult said application number before using the mentioned process for commercial or industrial purposes.

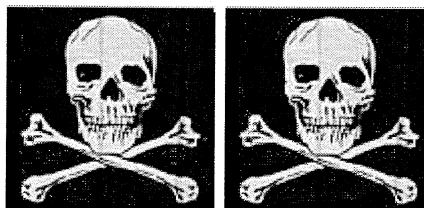
Chapter 10: Preparation of Nerve Agents



*Reaction equation (by-products omitted)*

<b>Materials:</b>	1. 53.6 grams of phosphorus trichloride	6. 2.6 grams of 48% hydrofluoric acid
	2. 52.2 grams of anhydrous aluminum chloride	7. 3.76 grams of anhydrous isopropyl alcohol
	3. 89.2 grams of isopropyl chloride	8. 30 grams of dry silica gel
	4. 340 milliliters of methylene chloride	9. 200+ milliliters of isopropyl ether
	5. 88 milliliters of 35 to 37% hydrochloric acid	

**Hazards:**



**WARNING! WARNING!**

Do not attempt in anyway to prepare sarin-isopropyl using the following procedure unless proper safety precautions are taken. 1) Perform all operations in a clean box, which is treated with a nitrogen atmosphere, and in which is completely sealed from the air. 2) After each procedure, all glassware and non-electric equipment should be soaked in a bleach (sodium hypochlorite) solution before removing from the clean box. Any electrical equipment such as hot plates and stirring equipment should be carefully wiped down with a bleached soaked rag before removing from the clean box. 3) After the entire operation is complete, the entire clean box should be disinfected with bleach before opening the clean box to the air. 4) The desired sarin-isopropyl product should be stored in amber bottles, preferably non-breakable containers, and stored in a cool dry place away from sunlight. The bottles should also be placed inside an airtight sealed plastic bag, such as a 'ziplock' bag. 5) Storage of any and all nerve agents should be in airtight cabinets, drawers, or the like, and said storage spaces should be equipped with chemical agent detection monitors to alert of any potential leakage.

Use caution when handling isopropyl phosphonic dichloride, which is highly toxic, and can be absorbed through the skin causing mild nerve agent symptoms. Use care when handling phosphorus trichloride, and aluminum chloride, both of which can cause irritation of the skin and eyes, and both of which violently react with water evolving corrosive and toxic fumes. Use great care when handling hydrofluoric acid. The acid is highly toxic, and can cause sever tissue, and bone damage. Acid spilled on the skin should immediately be washed with large amounts of water, and a baking soda solution. Any personnel exposed to hydrofluoric acid upon skin contact, or accidentally ingested should seek a hospital emergency room immediately for treatment. Wear gloves when handling concentrated hydrochloric acid, and avoid inhalation of the vapors.

## Step 1: Preparation of isopropyl phosphonic dichloride

Into a suitable flask equipped with a stirrer, and thermometer, place 52.2 grams of anhydrous aluminum chloride (pre-chilled to 0 Celsius), and then add 53.6 grams of pre-chilled anhydrous phosphorous trichloride. Then chill the flask to about 10 Celsius in an ice bath, and then add 89.2 grams of pre-chilled isopropyl chloride. Thereafter, stir the mixture for 30 minutes and maintain the reaction mixture temperature below 15 Celsius. Then seal the flask, and store in a refrigerator at 5 Celsius for 24 hours. Thereafter, filter-off the precipitated crystalline solid, and then vacuum dry the solid. Thereafter, place the vacuum dried crystalline solid into a desiccator filled with anhydrous sodium sulfate for 24 hours. After 24 hours, remove the dried crystalline solid, and then dissolve it into 340 milliliters of methylene chloride, and chill this methylene chloride mixture to -5 Celsius by means of a salt/ice bath. Thereafter, add drop-wise, 88 milliliters of 35 to 38% hydrochloric acid over a period of 2 hours, while stirring the reaction mixture, and maintaining its temperature at -5 Celsius. After the addition, filter-off any insoluble impurities, and then place the filtered reaction mixture into a separatory funnel and remove the upper water layer. Then place the lower methylene chloride layer into a rotary evaporator, and evaporate-off the methylene chloride under mild vacuum. When all the methylene chloride has been removed, remove the remaining residue and place into a clean vacuum distillation apparatus, and distill the residue at 76 Celsius under a vacuum of 23 millimeters of mercury to obtain a semi solid to liquid mass of isopropyl phosphonic dichloride.

## Step 2: Preparation of Sarin-isopropyl

Take 10 grams of the product obtained in step 1, place 5 grams of it into a suitable flask, and then add 50 milliliters of methylene chloride. Then cool the flask to 0 Celsius by means of an ice bath. When the temperature of the methylene chloride mixture reaches 0 Celsius, slowly add, drop-wise, 2.6 grams of 48% hydrofluoric acid. During the addition, stir the reaction mixture and keep its temperature around 0 Celsius. After the addition, stir the reaction mixture for 1 hour at 0 Celsius. After 1 hour, remove the ice bath, and then remove the upper water layer using a separatory funnel. Thereafter, pour the bottom methylene chloride layer into reflux apparatus, and gently reflux the mixture at about 60 Celsius while stirring for 1 hour. Afterwards, remove the heat source, and allow the reaction mixture to cool to room temperature. Then add the other 5 grams of the product obtained in step 1, 50 additional milliliters of methylene chloride, and then stir the mixture at room temperature for 15 minutes. Then add drop-wise, 3.76 grams of anhydrous isopropyl alcohol over a sufficient time as to keep the reaction mixture around room temperature. During the addition, stir the reaction mixture. After the addition, continue to stir the reaction mixture at room temperature for about 1 hour, and then place the reaction mixture into a reflux apparatus, and reflux at 60 Celsius for 1 hour. Thereafter, filter-off any precipitated impurities, and then place the filtered reaction mixture into a rotary evaporator or vacuum distillation apparatus, and remove the methylene chloride solvent under mild vacuum. If vacuum apparatus is not available, remove the methylene chloride by distillation at 40 Celsius. **Note: The methylene chloride mixture can be used directly in chemical warfare operations, when disseminated properly.** When the methylene chloride solvent has been evaporated, remove the remaining residue, and place it into a clean vacuum distillation apparatus, and distill the sarin-isopropyl at 87 Celsius under a vacuum of 30 millimeters of mercury to obtain a crude sarin-isopropyl product. **Note: this crude sarin-isopropyl product need not be purified for use in chemical warfare operations. Purification of the sarin-isopropyl is only desired if the sarin-isopropyl is to be mixed with other agents.**

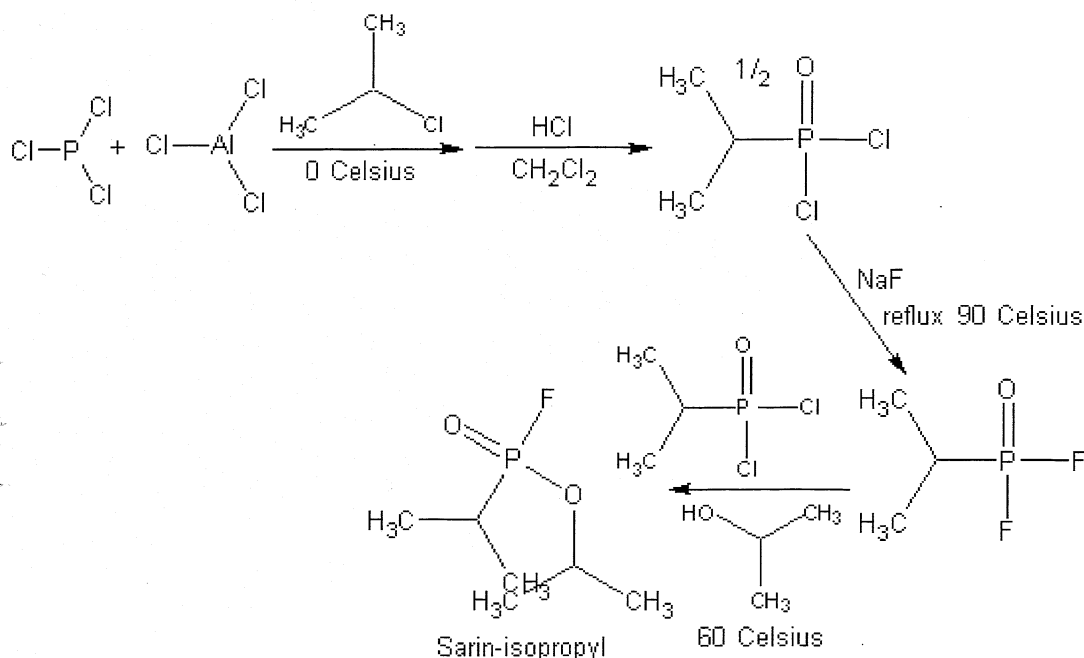
## Step 3: Purification of sarin-isopropyl

Setup the apparatus displayed in figure 046, thereafter prepare the silica gel with the following process: Pour 200 milliliters of distilled water into a suitable beaker, and then slowly pour in 30 grams of dry silica gel of 50 to 200 mesh while gradually stirring the mixture. After the addition of the silica gel, rapidly stir the mixture for 15 minutes, and thereafter, carefully decant-off the "fines". The fines are particles of matter that need to be removed to ensure a good flow rate. Then pour the silica gel into the glass column (make sure the glass column's stopcock is closed), as pictured in the following figure. Thereafter, pour in distilled water until the glass column is nearly full. Then gently open the stopcock, and drain off most of the water, until only about 10 centimeters of water remains above the silica gel layer. Then add 50 milliliters of dry isopropyl ether into the glass column, and then carefully drain-off the ether until most of it has passed through (by this time most of the water should have been removed). Thereafter, close the stopcock, and then add enough isopropyl ether into the glass column until the glass column is nearly full. Then, gently open the stopcock, and begin a very slow drip of the ether, and then at the same time, pour the crude sarin-isopropyl product, obtained in step 2, into the glass column, and allow it to slowly pass through the glass column, drip by drip. Now when the total liquid layer is about 10 centimeters above the silica gel layer, close the stopcock. Immediately thereafter, remove the washing portion from the apparatus (remove the receiver flask at the bottom), and pour the contents into a clean beaker. Then replace said receiver flask with a clean one, and then pour enough fresh isopropyl ether into the glass column until the glass column is nearly full (make sure the stopcock is closed). Then open the stopcock to form a gentle drip, and then immediately add in the ether-washing portion (containing the sarin-isopropyl) contained in the beaker into the glass column. Allow most of the ether to drain into the receiver flask. After which, remove the receiver flask from the apparatus, and then remove any water by placing the mixture into a separatory funnel, and draining off the bottom water layer. After any water has been removed, place the ether mixture into a clean rotary evaporator, and distill-off the isopropyl ether under mild vacuum. When all the ether has been removed, take out the remaining residue, and place into a clean vacuum distillation apparatus. Then distill the sarin-isopropyl at 87 Celsius under a vacuum of 30 millimeters of mercury to obtain a purified sarin-isopropyl product. **Note: instead of distilling-off the isopropyl ether, the ether mixture may be used in chemical warfare operations, and is actually preferred as a**

method of storing, preserving, and protecting the sarin-isopropyl from decomposition. Mixtures of sarin-isopropyl with ether, or methylene chloride can be effectively used to disseminate the sarin-isopropyl in wartime operations. Mixtures of sarin-isopropyl in a solvent such as methylene chloride or ether may persist up to two or three times longer than straight sarin-isopropyl in wartime operations.

### Procedure 04-008B: Preparation of Sarin-isopropyl (sodium fluoride process)

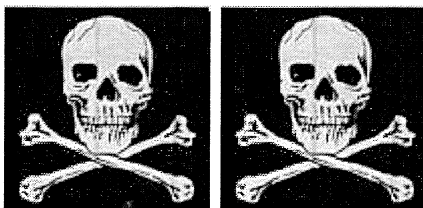
**Summary:** Sarin-isopropyl can be made using a modified process where by sodium fluoride is the fluorinating agent rather than the dangerous to handle hydrofluoric acid. The first step is the preparation of the already discussed isopropyl phosphonic dichloride. The second step is the preparation of the difluoride, which is accomplished by refluxing sodium fluoride with half of the isopropyl phosphonic dichloride. The resulting difluoride is then mixed with the other half of isopropyl phosphonic dichloride, and then treated with isopropyl alcohol. The sarin-isopropyl can then be purified using the usual methods. Note: The preparation of isopropyl phosphonic dichloride discussed in step 1, is similar or related to the process discussed in serial number 292,390 June 7<sup>th</sup>, 1952 by John P. Clay, assigned by Dugway Proving Grounds. This process may be protected by industrial/commercial process applications. Consult said application number before using the mentioned process for commercial or industrial purposes.



*Reaction equation (by-products omitted)*

<b>Materials:</b>	1. 53.6 grams of phosphorus trichloride	6. 2.6 grams of sodium fluoride
	2. 52.2 grams of anhydrous aluminum chloride	7. 3.76 grams of anhydrous isopropyl alcohol
	3. 89.2 grams of isopropyl chloride	8. 30 grams of dry silica gel
	4. 440 milliliters of methylene chloride	9. 200+ milliliters of isopropyl ether
	5. 88 milliliters of 35 to 37% hydrochloric acid	10. 100 milliliters of toluene

#### Hazards:



**WARNING! WARNING!**

Do not attempt in anyway to prepare sarin-isopropyl using the following procedure unless proper safety precautions are taken. 1) Perform all operations in a clean box, which is treated with a nitrogen atmosphere, and in which is completely sealed from the air. 2) After each procedure, all glassware and non-electric equipment should be soaked in

## Chapter 10: Preparation of Nerve Agents

a bleach (sodium hypochlorite) solution before removing from the clean box. Any electrical equipment such as hot plates and stirring equipment should be carefully wiped down with a bleached soaked rag before removing from the clean box. 3) After the entire operation is complete, the entire clean box should be disinfected with bleach before opening the clean box to the air. 4) The desired sarin-isopropyl product should be stored in amber bottles, preferably non-breakable containers, and stored in a cool dry place away from sunlight. The bottles should also be placed inside an airtight sealed plastic bag, such as a 'ziplock' bag. 5) Storage of any and all nerve agents should be in airtight cabinets, drawers, or the like, and said storage spaces should be equipped with chemical agent detection monitors to alert of any potential leakage.

Use caution when handling isopropyl phosphonic dichloride, which is highly toxic, and can be absorbed through the skin causing mild nerve agent symptoms. Use care when handling phosphorus trichloride, and aluminum chloride, both of which can cause irritation of the skin and eyes, and both of which violently react with water evolving corrosive and toxic fumes. Avoid inhalation of toluene vapors, as they are potentially carcinogenic. Wear gloves when handling sodium fluoride, and avoid ingestion and skin absorption. Wear gloves when handling concentrated hydrochloric acid, and avoid inhalation of the vapors.

### Procedure:

#### Step 1: Preparation of isopropyl phosphonic dichloride

Into a suitable flask equipped with a stirrer, and thermometer, place 52.2 grams of anhydrous aluminum chloride (pre-chilled to 0 Celsius), and then add 53.6 grams of pre-chilled anhydrous phosphorous trichloride. Then chill the flask to about 10 Celsius in an ice bath, and then add 89.2 grams of pre-chilled isopropyl chloride. Thereafter, stir the mixture for 30 minutes and maintain the reaction mixture temperature below 15 Celsius. Then seal the flask, and store in a refrigerator at 5 Celsius for 24 hours. Thereafter, filter-off the precipitated crystalline solid, and then vacuum dry the solid. Thereafter, place the vacuum dried crystalline solid into a desiccator filled with anhydrous sodium sulfate for 24 hours. After 24 hours, remove the dried crystalline solid, and then dissolve it into 340 milliliters of methylene chloride, and chill this methylene chloride mixture to -5 Celsius by means of a salt/ice bath. Thereafter, add drop-wise, 88 milliliters of 35 to 38% hydrochloric acid over a period of 2 hours, while stirring the reaction mixture, and maintaining its temperature at -5 Celsius. After the addition, filter-off any insoluble impurities, and then place the filtered reaction mixture into a separatory funnel and remove the upper water layer. Then place the lower methylene chloride layer into a rotary evaporator, and evaporate-off the methylene chloride under mild vacuum. When all the methylene chloride has been removed, remove the remaining residue and place into a clean vacuum distillation apparatus, and distill the residue at 76 Celsius under a vacuum of 23 millimeters of mercury to obtain a semi solid to liquid mass of isopropyl phosphonic dichloride.

#### Step 2: Preparation of sarin-isopropyl

Take 10 grams of the product obtained in step 1, place 5 grams of it into a suitable flask, and then add 100 milliliters of toluene. Thereafter, add 2.6 grams of anhydrous sodium fluoride and then begin rapidly stirring the mixture. Then place the mixture into a reflux apparatus and reflux the mixture at 90 Celsius for 1 hour. After refluxing for 1 hour, remove the heat source, and then allow the reaction mixture to cool to room temperature. Thereafter, filter the reaction mixture to remove any insoluble impurities, and then place the filtered reaction mixture into a rotary evaporator, and evaporate-off the toluene under vacuum. When all the toluene has been removed, remove the remaining residue, and then place said residue into a clean flask, and then add 100 milliliters of methylene chloride, followed by the other 5 grams of the product obtained in step 1. Note: stir the mixture thereafter to dissolve the residue into the methylene chloride. Then add drop wise, 3.76 grams of anhydrous isopropyl alcohol over a period of about 5 minutes, while stirring the reaction mixture and maintaining the reaction mixture temperature at room temperature. After the addition of the isopropyl alcohol, continue to stir the reaction mixture for 1 hour at room temperature. Thereafter, reflux the reaction mixture at 60 Celsius for 1 hour while stirring. After the reflux period, remove the heat source and allow the reaction mixture to cool to room temperature. Then filter the reaction mixture to remove any insoluble impurities, and then place the filtered reaction mixture into a rotary evaporator and evaporate-off the methylene chloride under mild vacuum. If vacuum apparatus is unavailable, distill-off the methylene chloride at 40 Celsius. **Note: The methylene chloride mixture can be used directly in chemical warfare operations, when disseminated properly.** When the methylene chloride has been removed, remove the remaining residue and place into a clean vacuum distillation apparatus, and distill the sarin-isopropyl at 87 Celsius under a vacuum of 30 millimeters of mercury to obtain a crude sarin-isopropyl product. **Note: this crude sarin-ethyl product need not be purified for use in chemical warfare operations. Purification of the sarin-isopropyl is only desired if the sarin-isopropyl is to be mixed with other agents.**

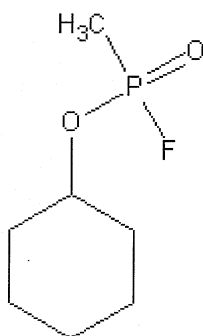
#### Step 3: Purification of sarin-isopropyl

Setup the apparatus displayed in figure 046, thereafter prepare the silica gel with the following process: Pour 200 milliliters of distilled water into a suitable beaker, and then slowly pour in 30 grams of dry silica gel of 50 to 200 mesh while gradually stirring the mixture. After the addition of the silica gel, rapidly stir the mixture for 15 minutes, and thereafter, carefully decant-off the "fines". The fines are particles of matter that need to be removed to ensure a good flow rate. Then pour the silica gel into the glass column (make sure the



glass column's stopcock is closed), as pictured in the following figure. Thereafter, pour in distilled water until the glass column is nearly full. Then gently open the stopcock, and drain off most of the water, until only about 10 centimeters of water remains above the silica gel layer. Then add 50 milliliters of dry isopropyl ether into the glass column, and then carefully drain-off the ether until most of it has passed through (by this time most of the water should have been removed). Thereafter, close the stopcock, and then add enough isopropyl ether into the glass column until the glass column is nearly full. Then, gently open the stopcock, and begin a very slow drip of the ether, and then at the same time, pour the crude sarin-isopropyl product, obtained in step 2, into the glass column, and allow it to slowly pass through the glass column, drip by drip. Now when the total liquid layer is about 10 centimeters above the silica gel layer, close the stopcock. Immediately thereafter, remove the washing portion from the apparatus (remove the receiver flask at the bottom), and pour the contents into a clean beaker. Then replace said receiver flask with a clean one, and then pour enough fresh isopropyl ether into the glass column until the glass column is nearly full (make sure the stopcock is closed). Then open the stopcock to form a gentle drip, and then immediately add in the ether-washing portion (containing the sarin-isopropyl) contained in the beaker into the glass column. Allow most of the ether to drain into the receiver flask. After which, remove the receiver flask from the apparatus, and then remove any water by placing the mixture into a separatory funnel, and draining off the bottom water layer. After any water has been removed, place the ether mixture into a clean rotary evaporator, and distill-off the isopropyl ether under mild vacuum. When all the ether has been removed, take out the remaining residue, and place into a clean vacuum distillation apparatus. Then distill the sarin-isopropyl at 87 Celsius under a vacuum of 30 millimeters of mercury to obtain a purified sarin-isopropyl product. **Note: instead of distilling-off the isopropyl ether, the ether mixture may be used in chemical warfare operations, and is actually preferred as a method of storing, preserving, and protecting the sarin-isopropyl from decomposition. Mixtures of sarin-isopropyl with ether, or methylene chloride can be effectively used to disseminate the sarin-isopropyl in wartime operations. Mixtures of sarin-isopropyl in a solvent such as methylene chloride or ether may persist up to two or three times longer than straight sarin-isopropyl in wartime operations.**

#### 04-009. Cyclosarin. GF. O-Cyclohexylmethylfluorophosphate; *CMPF*



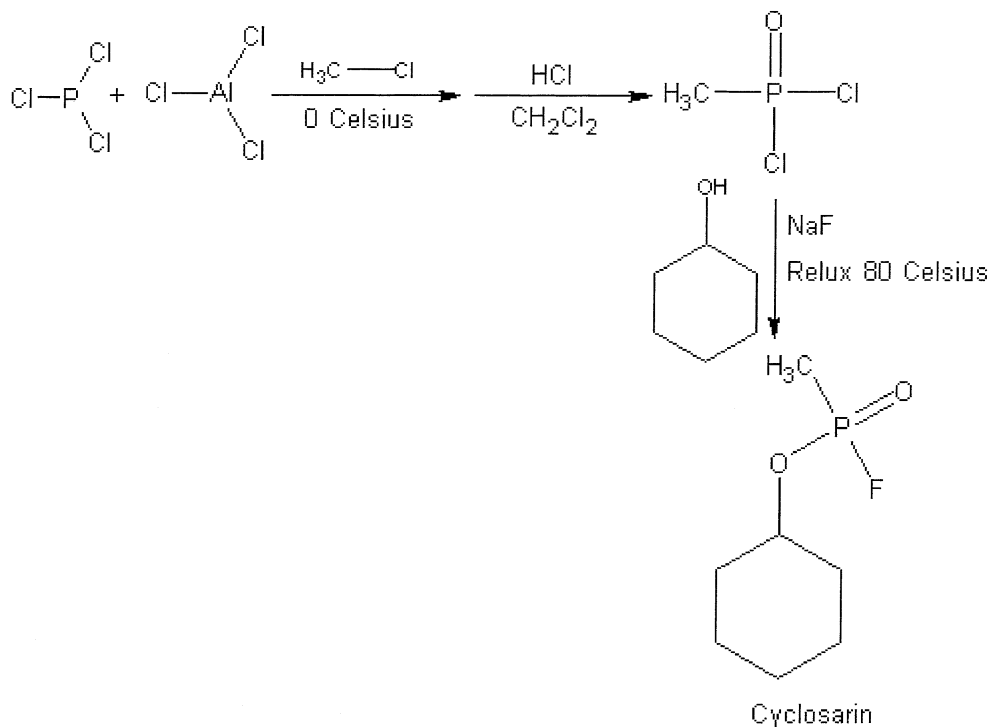
Cyclosarin

Cyclosarin from a colorless liquid, which may be colored amber to brown when impure. As with the usual nerve agents, it is odorless when pure. Impure cyclosarin may have variable odors ranging from fruity, to hay-like. It has a melting point of -30 Celsius, and a boiling point of 239 Celsius. Cyclosarin can be distilled at 104 Celsius under a vacuum of 10 millimeters of mercury. Cyclosarin is insoluble in water (15 grams per liter), and is not decomposed by it under normal conditions. It is only decomposed by water when heated. The high stability of cyclosarin to hydrolysis makes it much more persistent than sarin, tabun, or soman. Cyclosarin is also very persistent to volatility, as it evaporates 20 times slower than water. Cyclosarin is very soluble in the usual organic solvents. Cyclosarin is much more desirable than sarin, or soman in military operations. Environments contaminated with cyclosarin may remain effectively contaminated for up to 1 month under normal conditions. As with the usual nerve agents, cyclosarin is easily decomposed by bleaching powder or by alkalies. It can be disseminated using aerosols, explosives munitions, atomizers or humidifiers, or foggers. **Cyclosarin is a fast acting nerve agent capable of producing casualties within minutes of dissemination. The lethal dose for cyclosarin in the average man may vary, but is about 900 micrograms to 1200 micrograms per person by inhalation. Personnel exposed to non-lethal quantities may still suffer from incapacitating effects hours or weeks after exposure. Personnel exposed to lethal concentrations will be dead within 15 to 60 minutes of exposure. Cyclosarin is highly toxic through ingestion, inhalation, and skin and eye absorption.**

OVERALL RATING (scale from 1 to 10)	
<i>Effectiveness (as nerve agent): 8</i>	<i>Field Stability: 9</i>
<i>Persistence (open area): 9</i>	<i>Storage stability: 9</i>
<i>Persistence (enclosed area): 9</i>	<i>Toxicity (as nerve agent): 8</i>

**Procedure 04-009A: Preparation of Cyclosarin (standard sodium fluoride process)**

**Summary:** Cyclosarin is easily prepared using a convenient three-step process, starting with the preparation of methyl phosphonic dichloride. The methyl phosphonic dichloride is easily made by reacting methyl chloride, and phosphorus trichloride in the presence of anhydrous aluminum chloride to form an insoluble complex. This insoluble complex is then recovered by filtration, dissolved in suitable solvent, and then hydrolyzed with concentrated hydrochloric acid. The hydrolyzed product is the methyl phosphonic dichloride. The methyl phosphonic dichloride is then treated with a mixture of sodium fluoride and cyclohexanol in toluene. The resulting reaction mixture is then refluxed at moderate temperature, allowed to cool, and then filtered. The filtered reaction mixture is then distilled to yield a crude cyclosarin product, which is then purified by the usual manner.



*Reaction equation (by-products omitted)*

<b>Materials:</b>	1. 10 grams of phosphorus trichloride	6. 3.1 grams of sodium fluoride
	2. 9.7 grams of anhydrous aluminum chloride	7. 5.3 grams of anhydrous cyclohexanol
	3. 11 grams of methyl chloride	8. 30 grams of dry silica gel
	4. 146 milliliters of methylene chloride	9. 200+ milliliters of isopropyl ether
	5. 18.4 milliliters of 35 to 37% hydrochloric acid	10. 100 milliliters of toluene

**Hazards:**

**WARNING! WARNING! WARNING!**

Do not attempt in anyway to prepare cyclosarin using the following procedure unless proper safety precautions are taken. 1) Perform all operations in a clean box, which is treated with a nitrogen atmosphere, and in which is completely sealed from the air. 2) After each procedure, all glassware and non-electric equipment should be soaked in a bleach (sodium hypochlorite) solution before removing from the clean box. Any electrical equipment such as hot

## Chapter 10: Preparation of Nerve Agents

plates and stirring equipment should be carefully wiped down with a bleached soaked rag before removing from the clean box. 3) After the entire operation is complete, the entire clean box should be disinfected with bleach before opening the clean box to the air. 4) The desired cyclosarin product should be stored in amber bottles, preferably non-breakable containers, and stored in a cool dry place away from sunlight. The bottles should also be placed inside an airtight sealed plastic bag, such as a 'ziplock' bag. 5) Storage of any and all nerve agents should be in airtight cabinets, drawers, or the like, and said storage spaces should be equipped with chemical agent detection monitors to alert of any potential leakage.

Use caution when handling methyl phosphonic dichloride, which is highly toxic, and can be absorbed through the skin causing mild nerve agent symptoms. Use care when handling phosphorus trichloride, and aluminum chloride, both of which can cause irritation of the skin and eyes, and both of which violently react with water evolving corrosive and toxic fumes. Avoid inhalation of toluene vapors, as they are potentially carcinogenic. Wear gloves when handling sodium fluoride, and avoid ingestion and skin absorption. Wear gloves when handling concentrated hydrochloric acid, and avoid inhalation of the vapors.

### Procedure:

#### Step 1: Preparation of methyl phosphonic dichloride

Place 10 grams of pure phosphorus trichloride, 9.7 grams of pure anhydrous aluminum chloride, and a lecture bottle of anhydrous methyl chloride into a freezer, and chill to 0 Celsius prior to the following: Into a suitable glass stoppered bottle, place 9.7 grams of cold anhydrous aluminum chloride, and then 10 grams of cold phosphorus trichloride. Shortly thereafter, transfer in 11 grams of liquid methyl chloride. Then, stopper the bottle, and then shake the bottle for 1 hour to dissolve all solids. Note: Use caution as heat of reaction may boil-off some of the liquid methyl chloride producing dangerous pressures. If need be, the liquid methyl chloride can be replaced by rapidly bubbling 11 grams of ice cold methyl chloride gas into the phosphorus trichloride/aluminum chloride mixture, followed by stoppering the flask, and then shaking for 1 hour to dissolve all solids. After 1 hour, stop shaking, and then place the stoppered flask into a freezer and chill at 0 Celsius for 24 hours. After 24 hours, filter-off the precipitated solid, and then allow it dry in a desiccator filled with anhydrous sodium sulfate. When the solid is thoroughly dry, dissolve it into 146 milliliters of methylene chloride, and then chill this mixture to 0 Celsius by use of an ice bath. Then, place 18.4 milliliters of cold 35 to 37% hydrochloric acid into an addition funnel, and then add this acid, drop wise (at the rate of 10 drops per minute), to the methylene chloride mixture. Stir the methylene chloride mixture thoroughly during the addition of the hydrochloric acid. After the addition of the hydrochloric acid, continue to stir the reaction mixture for 90 minutes, while keeping the temperature at 5 Celsius or lower during the whole time. After stirring for 2 hours, filter-off any insoluble impurities, and then remove the upper water layer using a separatory funnel. Thereafter, place the methylene chloride layer into a distillation apparatus, or rotary evaporator, and then remove the methylene chloride solvent under vacuum. Note: if vacuum apparatus is unavailable, carefully distilling-off the methylene chloride at 40 Celsius can be used. After the solvent has been removed, place the remaining material into a clean rotary evaporator, or vacuum distillation apparatus, and distil the methyl phosphonic dichloride at 28 millimeters of mercury to obtain a semi-solid colorless mass, or clear liquid of methyl phosphonic dichloride.

#### Step 2: Preparation of cyclosarin

Into a suitable flask, place 100 milliliters of anhydrous toluene, 3.1 grams of anhydrous sodium fluoride, and then 5.3 grams of anhydrous cyclohexanol. Thereafter stir the mixture at room temperature for 15 minutes or until all ingredients are dissolved. Then heat the mixture to 80 Celsius under reflux, and when the temperature reaches 80 Celsius, slowly add portion wise, 10 grams of the product obtained in step 1. After the addition of the methyl phosphonic dichloride product obtained in step 1, continue to stir the reaction mixture, and then reflux the reaction mixture at 80 Celsius for about 1 hour. After 1 hour, remove the heat source, and allow the reaction mixture to cool to room temperature. Thereafter, filter the reaction mixture to remove any insoluble impurities, and then place the filtered reaction mixture into a rotary evaporator, and evaporate-off the toluene under vacuum. **Note: The toluene mixture can be used directly in chemical warfare operations, when disseminated properly** When all the toluene has been removed, remove the remaining residue, and then place said residue into a clean vacuum distillation apparatus, and distill the cyclosarin at 104 Celsius under a vacuum of 10 millimeters of mercury to obtain a crude cyclosarin product. **Note: This crude cyclosarin product need not be purified for use in chemical warfare operations. Purification of the cyclosarin is only desired if the cyclosarin is to be mixed with other agents.**

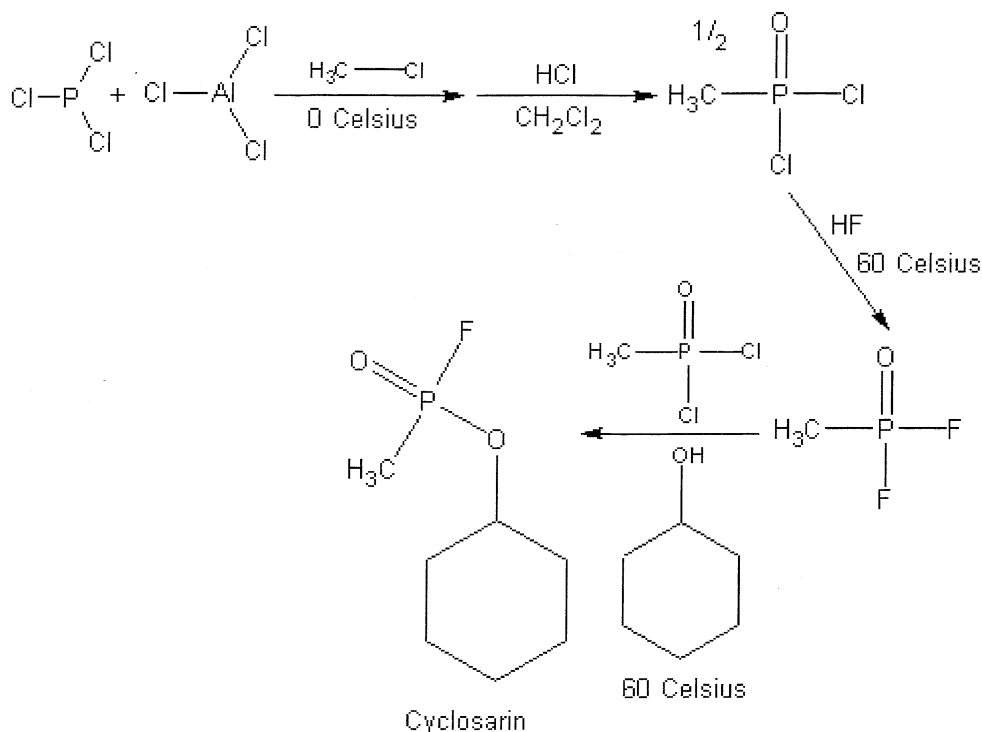
#### Step 3: Purification

Setup the apparatus displayed in figure 046, thereafter prepare the silica gel with the following process: Pour 200 milliliters of distilled water into a suitable beaker, and then slowly pour in 30 grams of dry silica gel of 50 to 200 mesh while gradually stirring the mixture. After the addition of the silica gel, rapidly stir the mixture for 15 minutes, and thereafter, carefully decant-off the "fines". The fines are particles of matter that need to be removed to ensure a good flow rate. Then pour the silica gel into the glass column (make sure the glass column's stopcock is closed), as pictured in the following figure. Thereafter, pour in distilled water until the glass column is

nearly full. Then gently open the stopcock, and drain off most of the water, until only about 10 centimeters of water remains above the silica gel layer. Then add 50 milliliters of dry isopropyl ether into the glass column, and then carefully drain-off the ether until most of it has passed through (by this time most of the water should have been removed). Thereafter, close the stopcock, and then add enough isopropyl ether into the glass column until the glass column is nearly full. Then, gently open the stopcock, and begin a very slow drip of the ether, and then at the same time, pour the crude cyclosarin product, obtained in step 2, into the glass column, and allow it to slowly pass through the glass column, drip by drip. Now when the total liquid layer is about 10 centimeters above the silica gel layer, close the stopcock. Immediately thereafter, remove the washing portion from the apparatus (remove the receiver flask at the bottom), and pour the contents into a clean beaker. Then replace said receiver flask with a clean one, and then pour enough fresh isopropyl ether into the glass column until the glass column is nearly full (make sure the stopcock is closed). Then open the stopcock to form a gentle drip, and then immediately add in the ether-washing portion (containing the cyclosarin) contained in the beaker into the glass column. Allow most of the ether to drain into the receiver flask. After which, remove the receiver flask from the apparatus, and then remove any water by placing the mixture into a separatory funnel, and draining off the bottom water layer. After any water has been removed, place the ether mixture into a clean rotary evaporator, and distill-off the isopropyl ether under mild vacuum. When all the ether has been removed, take out the remaining residue, and place into a clean vacuum distillation apparatus. Then vacuum distill the cyclosarin at 104 Celsius under a vacuum of 10 millimeters of mercury to obtain a purified cyclosarin product, well suitable for use in chemical warfare cocktails. **Note: instead of distilling-off the isopropyl ether, the ether mixture may be used in chemical warfare operations. Mixtures of cyclosarin with ether, or methylene chloride can be effectively used to disseminate the cyclosarin in wartime operations. Mixtures of cyclosarin in a solvent such as methylene chloride or ether may persist up to two or three times longer than straight cyclosarin in wartime operations within enclosed areas.**

### Procedure 04-009B: Preparation of Cyclosarin (preferred procedure)

**Summary:** Cyclosarin is easily prepared using a convenient three-step process, starting with the preparation of methyl phosphonic dichloride. The methyl phosphonic dichloride is easily made by reacting methyl chloride, and phosphorus trichloride in the presence of anhydrous aluminum chloride to form an insoluble complex. This insoluble complex is then recovered by filtration, dissolved in suitable solvent, and then hydrolyzed with concentrated hydrochloric acid. The hydrolyzed product is the methyl phosphonic dichloride. Half this product is then treated with hydrofluoric acid to produce methyl phosphonic difluoride. The fluoride intermediate is then treated with the other half of methyl phosphonic dichloride, and the mixture then treated with cyclohexanol. Step 3 is the purification process, which utilizes the standard silica gel column method.



*Reaction equation (by-products omitted)*

<b>Materials:</b>	1. 10 grams of phosphorus trichloride	6. 3.1 grams of 48% hydrofluoric acid
	2. 9.7 grams of anhydrous aluminum chloride	7. 5.3 grams of anhydrous cyclohexanol
	3. 11 grams of methyl chloride	8. 30 grams of dry silica gel

4. 296 milliliters of methylene chloride	9. 200+ milliliters of isopropyl ether
5. 18.4 milliliters of 35 to 37% hydrochloric acid	

**Hazards:**

Do not attempt in anyway to prepare cyclosarin using the following procedure unless proper safety precautions are taken. 1) Perform all operations in a clean box, which is treated with a nitrogen atmosphere, and in which is completely sealed from the air. 2) After each procedure, all glassware and non-electric equipment should be soaked in a bleach (sodium hypochlorite) solution before removing from the clean box. Any electrical equipment such as hot plates and stirring equipment should be carefully wiped down with a bleached soaked rag before removing from the clean box. 3) After the entire operation is complete, the entire clean box should be disinfected with bleach before opening the clean box to the air. 4) The desired cyclosarin product should be stored in amber bottles, preferably non-breakable containers, and stored in a cool dry place away from sunlight. The bottles should also be placed inside an airtight sealed plastic bag, such as a 'ziplock' bag. 5) Storage of any and all nerve agents should be in airtight cabinets, drawers, or the like, and said storage spaces should be equipped with chemical agent detection monitors to alert of any potential leakage.

Use caution when handling methyl phosphonic dichloride, which is highly toxic, and can be absorbed through the skin causing mild nerve agent symptoms. Use care when handling phosphorus trichloride, and aluminum chloride, both of which can cause irritation of the skin and eyes, and both of which violently react with water evolving corrosive and toxic fumes. Use great care when handling hydrofluoric acid. The acid is highly toxic, and can cause sever tissue, and bone damage. Acid spilled on the skin should immediately be washed with large amounts of water, and a baking soda solution. Any personnel exposed to hydrofluoric acid upon the skin, or accidentally ingested should seek a hospital emergency room immediately for treatment. Wear gloves when handling concentrated hydrochloric acid, and avoid inhalation of the vapors.

**Procedure:****Step 1: Preparation of methyl phosphonic dichloride**

Place 10 grams of pure phosphorus trichloride, 9.7 grams of pure anhydrous aluminum chloride, and a lecture bottle of anhydrous methyl chloride into a freezer, and chill to 0 celsius prior to the following: Into a suitable glass stoppered bottle, place 9.7 grams of cold anhydrous aluminum chloride, and then 10 grams of cold phosphorus trichloride. Shortly thereafter, transfer in 11 grams of liquid methyl chloride. Then, stopper the bottle, and then shake the bottle for 1 hour to dissolve all solids. Note: Use caution as heat of reaction may boil-off some of the liquid methyl chloride producing dangerous pressures. If need be, the liquid methyl chloride can be replaced by rapidly bubbling 11 grams of ice cold methyl chloride gas into the phosphorus trichloride/aluminum chloride mixture, followed by stoppering the flask, and then shaking for 1 hour to dissolve all solids. After 1 hour, stop shaking, and then place the stoppered flask into a freezer and chill at 0 Celsius for 24 hours. After 24 hours, filter-off the precipitated solid, and then allow it dry in a desiccator filled with anhydrous sodium sulfate. When the solid is thoroughly dry, dissolve it into 146 milliliters of methylene chloride, and then chill this mixture to 0 Celsius by use of an ice bath. Then, place 18.4 milliliters of cold 35 to 37% hydrochloric acid into an addition funnel, and then add this acid, drop wise (at the rate of 10 drops per minute), to the methylene chloride mixture. Stir the methylene chloride mixture thoroughly during the addition of the hydrochloric acid. After the addition of the hydrochloric acid, continue to stir the reaction mixture for 90 minutes, while keeping the temperature at 5 Celsius or lower during the whole time. After stirring for 2 hours, filter-off any insoluble impurities, and then remove the upper water layer using a seperatory funnel. Thereafter, place the methylene chloride layer into a distillation apparatus, or rotary evaporator, and then remove the methylene chloride solvent under vacuum. Note: if vacuum apparatus is unavailable, carefully distilling-off the methylene chloride at 40 Celsius can be used. After the solvent has been removed, place the remaining material into a clean rotary evaporator, or vacuum distillation apparatus, and distil the methyl phosphonic dichloride at 28 millimeters of mercury to obtain a semi-solid colorless mass, or clear liquid of methyl phosphonic dichloride.

**Step 2: Preparation of cyclosarin**

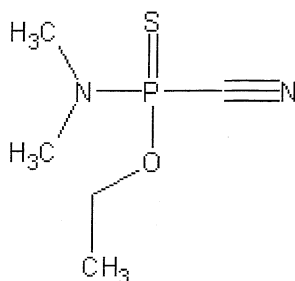
## Chapter 10: Preparation of Nerve Agents

Too 10 grams of the product obtained in step 1, place 5 grams of it into a suitable flask, and then add 100 milliliters of methylene chloride. Then cool the flask to 0 Celsius by means of an ice bath. When the temperature of the methylene chloride mixture reaches 0 Celsius, slowly add, drop-wise, 3.1 grams of 48% hydrofluoric acid. During the addition, stir the reaction mixture and keep its temperature around 0 Celsius. After the addition, stir the reaction mixture for 1 hour at 0 Celsius. After 1 hour, remove the ice bath, and then remove the upper water layer using a separatory funnel. Thereafter, pour the bottom methylene chloride layer into a reflux apparatus, and gently reflux the mixture at about 60 Celsius while stirring for 1 hour. Afterwards, remove the heat source, and allow the reaction mixture to cool to room temperature. Then add the other 5 grams of the product obtained in step 1, 50 additional milliliters of methylene chloride, and then stir the mixture at room temperature for 15 minutes. Then add portion-wise, 5.3 grams of anhydrous cyclohexanol over a sufficient time as to keep the reaction mixture around room temperature. During the addition, stir the reaction mixture. After the addition, continue to stir the reaction mixture at room temperature for about 1 hour, and then place the reaction mixture into a reflux apparatus, and reflux at 60 Celsius for 1 hour. Thereafter, filter-off any precipitated impurities, and then place the filtered reaction mixture into a rotary evaporator or vacuum distillation apparatus, and remove the methylene chloride solvent under mild vacuum. If vacuum apparatus is not available, remove the methylene chloride by distillation at 40 Celsius. **Note: The methylene chloride mixture can be used directly in chemical warfare operations, when disseminated properly.** When the methylene chloride solvent has been evaporated, remove the remaining residue, and place it into a clean vacuum distillation apparatus, and distil the cyclosarin at 104 Celsius under a vacuum of 10 millimeters of mercury to obtain a crude cyclosarin product. **Note: this crude cyclosarin product need not be purified for use in chemical warfare operations. Purification of the cyclosarin is only desired if the cyclosarin is to be mixed with other agents.**

### Step 3: Purification

Setup the apparatus displayed in figure 046, thereafter prepare the silica gel with the following process: Pour 200 milliliters of distilled water into a suitable beaker, and then slowly pour in 30 grams of dry silica gel of 50 to 200 mesh while gradually stirring the mixture. After the addition of the silica gel, rapidly stir the mixture for 15 minutes, and thereafter, carefully decant-off the "fines". The fines are particles of matter that need to be removed to ensure a good flow rate. Then pour the silica gel into the glass column (make sure the glass column's stopcock is closed), as pictured in the following figure. Thereafter, pour in distilled water until the glass column is nearly full. Then gently open the stopcock, and drain off most of the water, until only about 10 centimeters of water remains above the silica gel layer. Then add 50 milliliters of dry isopropyl ether into the glass column, and then carefully drain-off the ether until most of it has passed through (by this time most of the water should have been removed). Thereafter, close the stopcock, and then add enough isopropyl ether into the glass column until the glass column is nearly full. Then, gently open the stopcock, and begin a very slow drip of the ether, and then at the same time, pour the crude cyclosarin product, obtained in step 2, into the glass column, and allow it to slowly pass through the glass column, drip by drip. Now when the total liquid layer is about 10 centimeters above the silica gel layer, close the stopcock. Immediately thereafter, remove the washing portion from the apparatus (remove the receiver flask at the bottom), and pour the contents into a clean beaker. Then replace said receiver flask with a clean one, and then pour enough fresh isopropyl ether into the glass column until the glass column is nearly full (make sure the stopcock is closed). Then open the stopcock to form a gentle drip, and then immediately add in the ether-washing portion (containing the cyclosarin) contained in the beaker into the glass column. Allow most of the ether to drain into the receiver flask. After which, remove the receiver flask from the apparatus, and then remove any water by placing the mixture into a separatory funnel, and draining off the bottom water layer. After any water has been removed, place the ether mixture into a clean rotary evaporator, and distill-off the isopropyl ether under mild vacuum. When all the ether has been removed, take out the remaining residue, and place into a clean vacuum distillation apparatus. Then vacuum distill the cyclosarin under at 104 Celsius under a vacuum of 10 millimeters of mercury to obtain a purified cyclosarin product, well suitable for use in chemical warfare cocktails. **Note: instead of distilling-off the isopropyl ether, the ether mixture may be used in chemical warfare operations. Mixtures of cyclosarin with ether, or methylene chloride can be effectively used to disseminate the cyclosarin in wartime operations. Mixtures of cyclosarin in a solvent such as methylene chloride or ether may persist up to two or three times longer than straight cyclosarin in wartime operations.**

### 04-010. ThioTabun. GAA. *Diethylamidoethoxythiophosphorus cyanide; N-Diethylthiophosphoramidocyanidate*



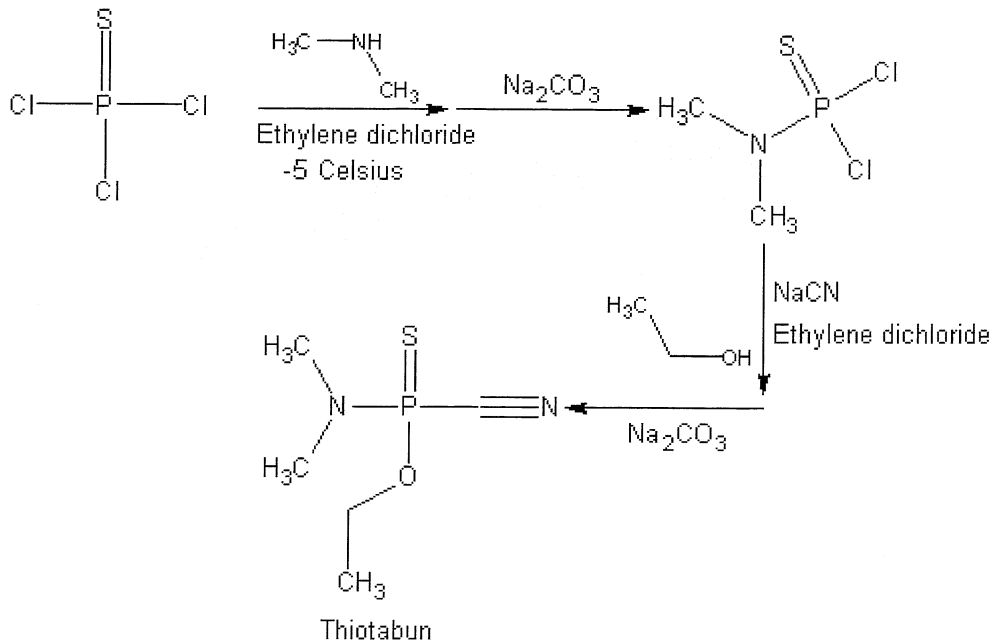
Chapter 10: Preparation of Nerve Agents  
Thiotabun

Very little data exists on thiotabun, but it is a colorless to yellowish liquid with a boiling point of 208 Celsius at 760 millimeters of mercury (begins to decompose around 150 Celsius). It can be distilled under vacuum at 86 Celsius under 10 millimeters of mercury. It has a faint fishy odor or a slight almond like odor. As with most nerve agents, absolute pure thiotabun is probably odorless. It is safe to predict that thiotabun would be closely related to tabun in physical properties, and characteristics. The stability of thiotabun in water is probably greater than tabun, and as result, so is its environmental persistence. Thiotabun is only very slightly soluble in water (62 grams per liter). The toxicity and persistence of thiotabun is probably similar to tabun but this information cannot be confirmed. As briefly stated, very little data exists on this compound so its unknown if thiotabun would have any potential use as a nerve agent. It is probably safe to assume that this compound would have definite use in military operations especially when mixed with other agents such as sarin, soman, or the nitrogen or sulfur mustards. Thiotabun may be used for training military personnel, and for calibrating chemical agent detection equipment in the field. It can be disseminated using aerosols, explosives munitions, atomizers or humidifiers, or foggers. **Thiotabun is a fast acting causality producing nerve agent capable of producing causalities within 24 hours of dissemination. The lethal dose for the average man is probably in the neighborhood of 1 to 5 milligrams (by inhalation). Thiotabun is highly toxic through ingestion, inhalation, and skin and eye absorption.**

OVERALL RATING (scale from 1 to 10)	
<i>Effectiveness (as nerve agent): 7</i>	<i>Field Stability: 9</i>
<i>Persistence (open area): 9</i>	<i>Storage stability: 9</i>
<i>Persistence (enclosed area): 9</i>	<i>Toxicity (as nerve agent): 7</i>
<b>TOTAL EFFECTIVENESS (as nerve agent): 8.3</b>	
<b>OVERALL TOXICITY (as warfare agent): 7½</b>	

**Procedure 04-010A: Preparation of Thiotabun**

**Summary:** Thioabun is readily prepared using a two-step process starting with the preparation of dimethylamido thiophosphorus dichloride. The dichloride intermediate is prepared by reacting dimethylamine with thiophosphorus trichloride in trichloroethylene solvent. The resulting amine hydrochloride salt is then simultaneously decomposed to the diemethylamido thiophosphorus dichloride by the addition of sodium carbonate. The dimethylamido thiophosphorus dichloride is then converted into thiotabun by reaction with sodium cyanide and ethyl alcohol in acetonitrile, followed by neutralization of the amine salt with sodium carbonate. The resulting reaction mixture is then stripped of solvent, and the remaining residue distilled to obtain refined thiotabun. Note: The preparation of dimethylamido thiophosphorus dichloride discussed in step 1, is similar or related to the process discussed in serial number 281,886 April 11<sup>th</sup>, 1952 by George A. Saul and Kenneth L. Godfrey, both of Virginia, assigned by Monsanto Chemical Company. This process may be protected by industrial/commercial process applications. Consult said application number before using the mentioned process for commercial or industrial purposes.



*Reaction Equation (by-products omitted)*

## Chapter 10: Preparation of Nerve Agents

<b>Materials:</b>	1. 169.4 grams of thiophosphorus trichloride	5. 5.5 grams of anhydrous sodium cyanide
	2. 580 grams trichloroethylene	6. 5.1 grams anhydrous ethyl alcohol (200 proof)
	3. 46 grams of anhydrous dimethylamine (lecture bottle)	7. 60 milliliters of acetonitrile
	4. 59 grams of anhydrous sodium carbonate	

### Hazards:



Do not attempt in anyway to prepare thiotabun using the following procedure unless proper safety precautions are taken. 1) Perform all operations in a clean box, which is treated with a nitrogen atmosphere, and in which is completely sealed from the air. 2) After each procedure, all glassware and non-electric equipment should be soaked in a bleach (sodium hypochlorite) solution before removing from the clean box. Any electrical equipment such as hot plates and stirring equipment should be carefully wiped down with a bleached soaked rag before removing from the clean box. 3) After the entire operation is complete, the entire clean box should be disinfected with bleach before opening the clean box to the air. 4) The desired thiotabun product should be stored in amber bottles, preferably non-breakable containers, and stored in a cool dry place away from sunlight. The bottles should also be placed inside an airtight sealed plastic bag, such as a 'ziplock' bag. 5) Storage of any and all nerve agents should be in airtight cabinets, drawers, or the like, and said storage spaces should be equipped with chemical agent detection monitors to alert of any potential leakage.

Use caution when handling dimethylamido thiophosphorus dichloride, which may cause nerve agent like symptoms if ingested or inhaled. Wear gloves when handling sodium cyanide, and acetonitrile, both of which can be absorbed by the skin leading to toxic results. Ethanol is flammable, so extinguish all flames before using. Use care when handling dimethylamine, which is an irritant.

### Procedure:

#### Step 1: Preparation of dimethylamido thiophosorus dichloride

Into a suitable flask place 169.4 grams of thiophosphorus trichloride, and then add 400 grams of trichloroethylene. Then stir the mixture for several minutes. Thereafter, place the mixture into a cold-water bath, and chill to 10 Celsius. When the temperature reaches 10 Celsius, slowly bubble into the mixture, 46 grams of anhydrous dimethylamine gas over a period sufficient to keep the reaction mixture below 30 Celsius. During the addition of the gaseous dimethylamine, vigorously stir the reaction mixture. After the addition, continue to stir the reaction mixture for 30 minutes at 10 Celsius, and then remove the reaction mixture from the cold water bath, and then place into an ice bath at 0 Celsius. When the temperature of the reaction mixture reaches 0 Celsius, slowly add, portion wise, 53 grams of anhydrous sodium carbonate, while stirring the reaction mixture. During the addition of the sodium carbonate, carbon dioxide gas will be steadily evolved. After the addition of the sodium carbonate, stir the reaction mixture at 0 Celsius for 30 minutes, and then filter-off any precipitated impurities. Then place the filtered reaction mixture into a rotary evaporator or vacuum distillation apparatus, and remove the trichloroethylene solvent under vacuum. When all the trichloroethylene solvent has been removed, remove the remaining residue and place into a clean vacuum distillation apparatus, and fractionally distill the residue under a vacuum of 16 millimeters of mercury, and at a temperature of 90 Celsius.

#### Step 2: Preparation of thiotabun

Into a suitable flask, add 180 grams of trichloroethylene, and then 20 grams of the product obtained in step 1. Thereafter, thoroughly blend the mixture to dissolve all solids. Then prepare a solution by adding and dissolving 5.5 grams of finely powdered anhydrous sodium cyanide into 60 milliliters of acetonitrile, and thereafter, add and dissolve 5.1 grams of anhydrous ethyl alcohol there into. Then place the flask containing the trichloroethylene mixture into an ice bath, and chill to 0 Celsius. Thereafter, slowly add drop-wise, the sodium cyanide/acetonitrile/ethyl alcohol solution, to the trichloroethylene mixture while vigorously stirring the trichloroethylene mixture and keeping its temperature around 0 Celsius. After the addition, continue to vigorously stir the reaction mixture for 1 hour at 0 Celsius, after which, remove the ice bath, and then reflux the entire reaction mixture for 90 minutes at 84 Celsius with vigorous stirring. After 90 minutes, remove the heat source, and allow the reaction mixture to cool to room temperature. Then place the reaction mixture into an ice water bath, and chill to 5 Celsius. Then gradually add in portions, 6 grams of anhydrous powdered sodium carbonate to the reaction mixture, and then vigorously stir the reaction mixture at room temperature for 30 minutes. Afterwards, filter-



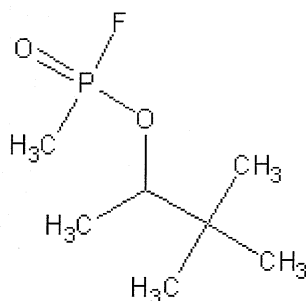
off any insoluble impurities, and then place the reaction mixture into a rotary evaporator, or vacuum distillation apparatus, and remove the trichloroethylene solvent, and acetonitrile solvent under vacuum. Note: These two solvents can be collected in the same receiver flask, and separated later, or fractionally distilled using two different angled liebig condensers. After the trichloroethylene and acetonitrile solvents have been removed, remove the remaining residue, and place into a clean vacuum distillation apparatus, and fractionally distill the thiotabun at 86 Celsius under a vacuum of 10 millimeters of mercury to obtain a refined tabun product.

Purification can be accomplished by using a silica gel column filled with aluminum oxide, and using methylene chloride solvent.

**Note: The refined thiotabun product can be dissolved in methylene chloride, ether, or any desired solvent, and used as such in chemical warfare operations when properly disseminated.**

#### 04-011. Soman. GD. Trilon. Pinacolyl methylphosphonofluoridate;

*Methylphosphonofluoridic acid 1,2,2-tri-methylpropyl ester.*



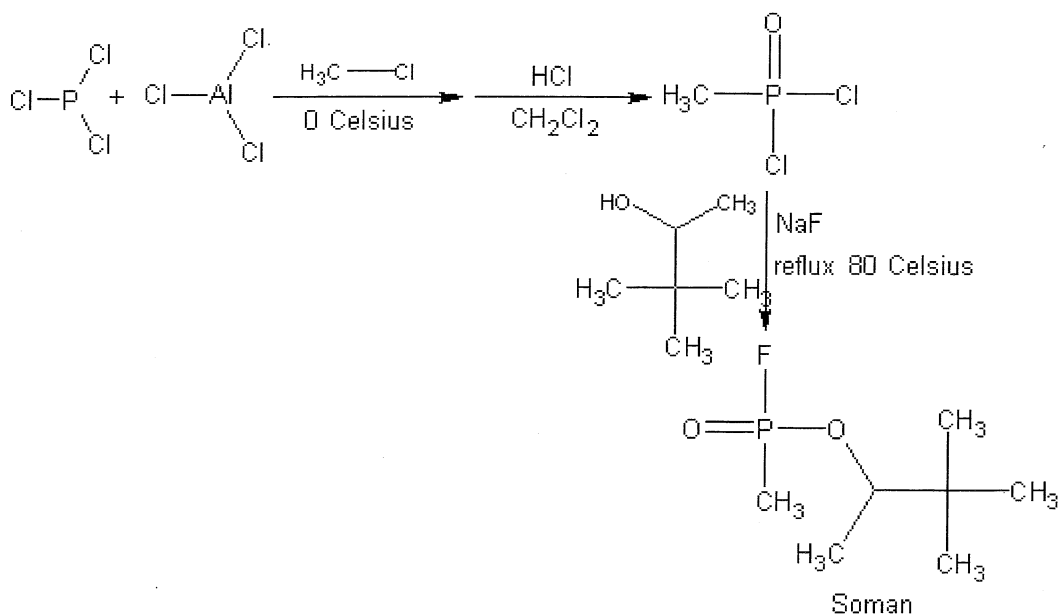
Soman

Soman is colorless, to lightly colored liquid with a boiling point of 198 Celsius, and a melting point of -30 Celsius. Impure soman may have a melting point ranging from -30 Celsius to -80 Celsius. It begins to decompose when heated at 130+ Celsius. It can be distilled at 84 Celsius under a vacuum of 15 millimeters of mercury. Impure or contaminated soman may be of any color ranging from light brown, amber, or yellow, to orange, to black all depending on what impurities may be present. Military grade soman is a colorless odorless liquid. Stabilized soman has a half-life of 2 hours at 130 Celsius, and a half-life of 1 hour at 130 Celsius when unstabilized. Solubility in water is 20 grams soman per 80 grams of water at room temperature. The stability of soman in water is much better than for sarin. Droplets of soman onto water may persist for several hours or days, depending on environmental conditions. During warm and moist or wet conditions, the persistence of soman is very low (1 to 2 days), but during dry and cool conditions the persistence of soman is quite well (most likely up to 2 days). Soman evaporates four times slower than water. As with sarin, soman is readily attacked by strong alkalis such as sodium hydroxide, sodium carbonate, or potassium bases. Soman itself is very soluble in the usual organic solvents including methylene chloride, dimethyl sulfoxide, ether, toluene, and dimethylformamide. Pure soman has no odor, but soman containing impurities may have a weak camphor like odor, weak pinacolyl alcohol odor, or weak odor of nutmeg. Impure soman may also have a slight odor of orange peel. Although pure soman is odorless, in some cases it may have a slight fruity odor. Standard military decontamination kits are more than satisfactory for its neutralization. Bleaching powder, or *Clorox* bleach decontaminates soman very well, and should be used in all cases to decontaminate, destroy, or clean any contaminated environments. Soman, like sarin is readily soluble in fats and lipids. It can be disseminated using aerosols, explosives munitions, atomizers or humidifiers, or foggers. *Note: One use of soman during military operations is to contaminate food supplies. During the event of a chemical war, the CIA and military personnel will attempt to distribute cooking oils and other food products contaminated with soman. During the Vietnam War the US military distributed soman containing cooking oil, rice, and vegetables to villagers in the hope that the enemy would use them. Meats such as pork, chicken, and beef can act as the perfect sponge, absorbing soman. When said meat is then cooked, the cooking process causes the soman to volatilize into the atmosphere, performing a perfect act of dissemination. The "chef", and any other personnel within the vicinity of the cooking meat will be exposed to such agent, causing the usual effects, and death. To this day, it is unknown how many Vietnamese personnel may have been exposed to such agents in said manner. As usual, the US government denies all involvement in such acts, and any attempt to prove the governments guilt may result in damage to ones career—a well known CNN reporter was fired after claiming the US used nerve gas during the Vietnam war—perhaps you remember who I am referring to. Soman is a fast acting nerve agent capable of producing casualties within minutes of dissemination. Toxicity: Lethal dose 50% of population i.p. in mice: 0.062 milligrams per kilogram of body weight, and 0.780 milligrams dermally in mice. The lethal dose for the average man is about 0.010 milligrams per kilogram (800 micrograms lethal dose for man of 180 pounds of weight). When used properly, 4 milligrams of soman can kill 5 soldiers. Personnel exposed to non-lethal amounts of the agent may still become incapacitated within 10 minutes of exposure, and will become unable to perform their normal duties as soldiers. Those personnel exposed to lethal doses will be dead within 60 minutes. Note: Soman is more effective in wartime operations than sarin, and is preferred 2 to1 over sarin in military operations. Soman is highly toxic through ingestion, inhalation, and skin and eye absorption.*

OVERALL RATING (scale from 1 to 10)	
<i>Effectiveness (as nerve agent): 8</i>	<i>Field Stability: 8</i>
<i>Persistence (open area): 7</i>	<i>Storage stability: 8</i>
<i>Persistence (enclosed area): 8</i>	<i>Toxicity (as nerve agent): 8½</i>
<b>TOTAL EFFECTIVENESS (as nerve agent): 7.9</b>	
<b>OVERALL TOXICITY (as warfare agent): 8¼</b>	

### Procedure 04-011A: Preparation of Soman (sodium fluoride process)

**Summary:** Soman is easily prepared using a convenient three-step process, starting with the preparation of methyl phosphonic dichloride. The methyl phosphonic dichloride is easily made by reacting methyl chloride, and phosphorus trichloride in the presence of anhydrous aluminum chloride to form an insoluble complex. This insoluble complex is then recovered by filtration, dissolved in suitable solvent, and then hydrolyzed with concentrated hydrochloric acid. The hydrolyzed product is the methyl phosphonic dichloride. The methyl phosphonic dichloride is then treated with a mixture of sodium fluoride and pinacolyl alcohol in toluene. The resulting reaction mixture is then refluxed at moderate temperature, allowed to cool, and then filtered. The filtered reaction mixture is then distilled to yield a crude soman product, which is then purified by the usual manner.



*Reaction equation (by-products omitted)*

<b>Materials:</b>	1. 10 grams of phosphorus trichloride	6. 3.1 grams of sodium fluoride
	2. 9.7 grams of anhydrous aluminum chloride	7. 5.4 grams pinacolyl alcohol
	3. 11 grams of methyl chloride	8. 30 grams of dry silica gel
	4. 146 milliliters of methylene chloride	9. 200+ milliliters of isopropyl ether
	5. 18.4 milliliters of 35 to 37% hydrochloric acid	10. 100 milliliters of toluene

#### Hazards:



**WARNING! WARNING! WARNING!**

Do not attempt in anyway to prepare soman using the following procedure unless proper safety precautions are taken.

1) Perform all operations in a clean box, which is treated with a nitrogen atmosphere, and in which is completely sealed from the air. 2) After each procedure, all glassware and non-electric equipment should be soaked in a bleach (sodium hypochlorite) solution before removing from the clean box. Any electrical equipment such as hot plates and

## Chapter 10: Preparation of Nerve Agents

stirring equipment should be carefully wiped down with a bleached soaked rag before removing from the clean box. 3) After the entire operation is complete, the entire clean box should be disinfected with bleach before opening the clean box to the air. 4) The desired soman product should be stored in amber bottles, preferably non-breakable containers, and stored in a cool dry place away from sunlight. The bottles should also be placed inside an airtight sealed plastic bag, such as a 'ziplock' bag. 5) Storage of any and all nerve agents should be in airtight cabinets, drawers, or the like, and said storage spaces should be equipped with chemical agent detection monitors to alert of any potential leakage. Use caution when handling methyl phosphonic dichloride, which is highly toxic, and can be absorbed through the skin causing mild nerve agent symptoms. Use care when handling phosphorus trichloride, and aluminum chloride, both of which can cause irritation of the skin and eyes, and both of which violently react with water evolving corrosive and toxic fumes. Avoid inhalation of toluene vapors, as they are potentially carcinogenic. Wear gloves when handling sodium fluoride, and avoid ingestion and skin absorption. Wear gloves when handling concentrated hydrochloric acid, and avoid inhalation of the vapors.

### Procedure:

#### Step 1: Preparation of methyl phosphonic dichloride

Place 10 grams of pure phosphorus trichloride, 9.7 grams of pure anhydrous aluminum chloride, and a lecture bottle of anhydrous methyl chloride into a freezer, and chill to 0 Celsius prior to the following: Into a suitable glass stoppered bottle, place 9.7 grams of cold anhydrous aluminum chloride, and then 10 grams of cold phosphorus trichloride. Shortly thereafter, transfer in 11 grams of liquid methyl chloride. Then, stopper the bottle, and then shake the bottle for 1 hour to dissolve all solids. Note: Use caution as heat of reaction may boil-off some of the liquid methyl chloride producing dangerous pressures. If need be, the liquid methyl chloride can be replaced by rapidly bubbling 11 grams of ice cold methyl chloride gas into the phosphorus trichloride/aluminum chloride mixture, followed by stoppering the flask, and then shaking for 1 hour to dissolve all solids. After 1 hour, stop shaking, and then place the stoppered flask into a freezer and chill at 0 Celsius for 24 hours. After 24 hours, filter-off the precipitated solid, and then allow it dry in a desiccator filled with anhydrous sodium sulfate. When the solid is thoroughly dry, dissolve it into 146 milliliters of methylene chloride, and then chill this mixture to 0 Celsius by use of an ice bath. Then, place 18.4 milliliters of cold 35 to 37% hydrochloric acid into an addition funnel, and then add this acid, drop wise (at the rate of 10 drops per minute), to the methylene chloride mixture. Stir the methylene chloride mixture thoroughly during the addition of the hydrochloric acid. After the addition of the hydrochloric acid, continue to stir the reaction mixture for 90 minutes, while keeping the temperature at 5 Celsius or lower during the whole time. After stirring for 2 hours, filter-off any insoluble impurities, and then remove the upper water layer using a separatory funnel. Thereafter, place the methylene chloride layer into a distillation apparatus, or rotary evaporator, and then remove the methylene chloride solvent under vacuum. Note: if vacuum apparatus is unavailable, carefully distilling-off the methylene chloride at 40 Celsius can be used. After the solvent has been removed, place the remaining material into a clean rotary evaporator, or vacuum distillation apparatus, and distil the methyl phosphonic dichloride at 28 millimeters of mercury to obtain a semi-solid colorless mass, or clear liquid of methyl phosphonic dichloride.

#### Step 2: Preparation of soman

Into a suitable flask, place 100 milliliters of anhydrous toluene, 3.1 grams of anhydrous sodium fluoride, and then 5.4 grams of anhydrous pinacolyl alcohol. Thereafter stir the mixture at room temperature for 15 minutes or until all ingredients are dissolved. Then heat the mixture to 80 Celsius under reflux, and when the temperature reaches 80 Celsius, slowly add portion wise, 10 grams of the product obtained in step 1. After the addition of the methyl phosphonic dichloride product obtained in step 1, continue to stir the reaction mixture, and then reflux the reaction mixture at 80 Celsius for about 1 hour. After 1 hour, remove the heat source, and allow the reaction mixture to cool to room temperature. Thereafter, filter the reaction mixture to remove any insoluble impurities, and then place the filtered reaction mixture into a rotary evaporator, and evaporate-off the toluene under vacuum. **Note: The toluene mixture can be used directly in chemical warfare operations, when disseminated properly** When all the toluene has been removed, remove the remaining residue, and then place said residue into a clean vacuum distillation apparatus, and distill the soman at 84 Celsius under a vacuum of 15 millimeters of mercury to obtain a crude soman product. **Note: This crude soman product need not be purified for use in chemical warfare operations. Purification of the soman is only desired if the soman is to be mixed with other agents.**

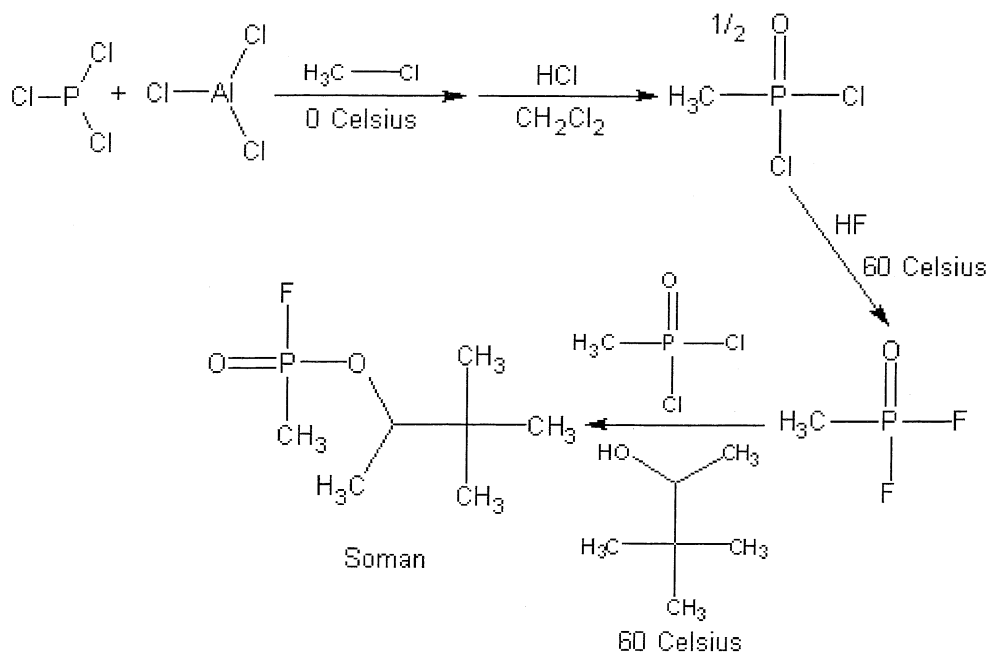
#### Step 3: Purification

Setup the apparatus displayed in figure 046, thereafter prepare the silica gel with the following process: Pour 200 milliliters of distilled water into a suitable beaker, and then slowly pour in 30 grams of dry silica gel of 50 to 200 mesh while gradually stirring the mixture. After the addition of the silica gel, rapidly stir the mixture for 15 minutes, and thereafter, carefully decant-off the "fines". The fines are particles of matter that need to be removed to ensure a good flow rate. Then pour the silica gel into the glass column (make sure the glass column's stopcock is closed), as pictured in the following figure. Thereafter, pour in distilled water until the glass column is nearly full. Then gently open the stopcock, and drain off most of the water, until only about 10 centimeters of water remains above the

silica gel layer. Then add 50 milliliters of dry isopropyl ether into the glass column, and then carefully drain-off the ether until most of it has passed through (by this time most of the water should have been removed). Thereafter, close the stopcock, and then add enough isopropyl ether into the glass column until the glass column is nearly full. Then, gently open the stopcock, and begin a very slow drip of the ether, and then at the same time, pour the crude soman product, obtained in step 2, into the glass column, and allow it to slowly pass through the glass column, drip by drip. Now when the total liquid layer is about 10 centimeters above the silica gel layer, close the stopcock. Immediately thereafter, remove the washing portion from the apparatus (remove the receiver flask at the bottom), and pour the contents into a clean beaker. Then replace said receiver flask with a clean one, and then pour enough fresh isopropyl ether into the glass column until the glass column is nearly full (make sure the stopcock is closed). Then open the stopcock to form a gentle drip, and then immediately add in the ether-washing portion (containing the soman) contained in the beaker into the glass column. Allow most of the ether to drain into the receiver flask. After which, remove the receiver flask from the apparatus, and then remove any water by placing the mixture into a separatory funnel, and draining off the bottom water layer. After any water has been removed, place the ether mixture into a clean rotary evaporator, and distill-off the isopropyl ether under mild vacuum. When all the ether has been removed, take out the remaining residue, and place into a clean vacuum distillation apparatus. Then vacuum distill the soman at 84 Celsius under a vacuum of 15 millimeters of mercury to obtain a purified soman product, well suitable for use in chemical warfare cocktails. **Note: instead of distilling-off the isopropyl ether, the ether mixture may be used in chemical warfare operations, and is actually preferred as a method of storing, preserving, and protecting the soman from decomposition. Mixtures of soman with ether, or methylene chloride can be effectively used to disseminate the soman in wartime operations. Mixtures of soman in a solvent such as methylene chloride or ether may persist up to two or three times longer than straight soman in wartime operations.**

### Procedure 04-011B: Preparation of Soman (preferred process)

**Summary:** Soman is easily prepared using a convenient three-step process, starting with the preparation of methyl phosphonic dichloride. The methyl phosphonic dichloride is easily made by reacting methyl chloride, and phosphorus trichloride in the presence of anhydrous aluminum chloride to form an insoluble complex. This insoluble complex is then recovered by filtration, dissolved in suitable solvent, and then hydrolyzed with concentrated hydrochloric acid. The hydrolyzed product is the methyl phosphonic dichloride. Half this product is then treated with hydrofluoric acid to produce methyl phosphonic difluoride. The fluoride intermediate is then treated with the other half of methyl phosphonic dichloride, and the mixture then treated with pinacolyl alcohol. Step 3 is the purification process, which utilizes the standard silica gel column method.



#### Reaction Equation (by-products omitted)

<b>Materials:</b>	1. 10 grams of phosphorus trichloride	6. 3.1 grams of 48% hydrofluoric acid
	2. 9.7 grams of anhydrous aluminum chloride	7. 5.4 grams of anhydrous pinacolyl alcohol
	3. 11 grams of methyl chloride	8. 30 grams of dry silica gel
	4. 246 milliliters of methylene chloride	9. 200+ milliliters of isopropyl ether
	5. 18.4 milliliters of 35 to 37% hydrochloric acid	

**Hazards:**

Do not attempt in anyway to prepare soman using the following procedure unless proper safety precautions are taken. 1) Perform all operations in a clean box, which is treated with a nitrogen atmosphere, and in which is completely sealed from the air. 2) After each procedure, all glassware and non-electric equipment should be soaked in a bleach (sodium hypochlorite) solution before removing from the clean box. Any electrical equipment such as hot plates and stirring equipment should be carefully wiped down with a bleached soaked rag before removing from the clean box. 3) After the entire operation is complete, the entire clean box should be disinfected with bleach before opening the clean box to the air. 4) The desired soman product should be stored in amber bottles, preferably non-breakable containers, and stored in a cool dry place away from sunlight. The bottles should also be placed inside an airtight sealed plastic bag, such as a 'ziplock' bag. 5) Storage of any and all nerve agents should be in airtight cabinets, drawers, or the like, and said storage spaces should be equipped with chemical agent detection monitors to alert of any potential leakage. Use caution when handling methyl phosphonic dichloride, which is highly toxic, and can be absorbed through the skin causing mild nerve agent symptoms. Use care when handling phosphorus trichloride, and aluminum chloride, both of which can cause irritation of the skin and eyes, and both of which violently react with water evolving corrosive and toxic fumes. Use great care when handling hydrofluoric acid. The acid is highly toxic, and can cause sever tissue, and bone damage. Acid spilled on the skin should immediately be washed with large amounts of water, and a baking soda solution. Any personnel exposed to hydrofluoric acid upon the skin, or accidentally ingested should seek a hospital emergency room immediately for treatment. Wear gloves when handling concentrated hydrochloric acid, and avoid inhalation of the vapors.

**Procedure:****Step 1: Preparation of methyl phosphonic dichloride**

Place 10 grams of pure phosphorus trichloride, 9.7 grams of pure anhydrous aluminum chloride, and a lecture bottle of anhydrous methyl chloride into a freezer, and chill to 0 celsius prior to the following: Into a suitable glass stoppered bottle, place 9.7 grams of cold anhydrous aluminum chloride, and then 10 grams of cold phosphorus trichloride. Shortly thereafter, transfer in 11 grams of liquid methyl chloride. Then, stopper the bottle, and then shake the bottle for 1 hour to dissolve all solids. Note: Use caution as heat of reaction may boil-off some of the liquid methyl chloride producing dangerous pressures. If need be, the liquid methyl chloride can be replaced by rapidly bubbling 11 grams of ice cold methyl chloride gas into the phosphorus trichloride/aluminum chloride mixture, followed by stoppering the flask, and then shaking for 1 hour to dissolve all solids. After 1 hour, stop shaking, and then place the stoppered flask into a freezer and chill at 0 Celsius for 24 hours. After 24 hours, filter-off the precipitated solid, and then allow it dry in a desiccator filled with anhydrous sodium sulfate. When the solid is thoroughly dry, dissolve it into 146 milliliters of methylene chloride, and then chill this mixture to 0 Celsius by use of an ice bath. Then, place 18.4 milliliters of cold 35 to 37% hydrochloric acid, and then add this acid, drop wise (at the rate of 10 drops per minute), to the methylene chloride mixture. Stir the methylene chloride mixture thoroughly during the addition of the hydrochloric acid. After the addition of the hydrochloric acid, continue to stir the reaction mixture for 90 minutes, while keeping the temperature at 5 Celsius or lower during the whole time. After stirring for 2 hours, filter-off any insoluble impurities, and then remove the upper water layer using a seperatory funnel. Thereafter, place the methylene chloride layer into a distillation apparatus, or rotary evaporator, and then remove the methylene chloride solvent under vacuum. Note: if vacuum apparatus is unavailable, carefully distilling-off the methylene chloride at 40 Celsius can be used. After the solvent has been removed, place the remaining material into a clean rotary evaporator, or vacuum distillation apparatus, and distil the methyl phosphonic dichloride at 28 millimeters of mercury to obtain a semi-solid colorless mass, or clear liquid of methyl phosphonic dichloride.

**Step 2: Preparation of soman**

Too 10 grams of the product obtained in step 1, place 5 grams of it into a suitable flask, and then add 50 milliliters of methylene chloride. Then cool the flask to 0 Celsius by means of an ice bath. When the temperature of the methylene chloride mixture reaches 0 Celsius, slowly add, drop-wise, 3.1 grams of 48% hydrofluoric acid. During the addition, stir the reaction mixture and keep it's temperature around 0 Celsius. After the addition, stir the reaction mixture for 1 hour at 0 Celsius. After 1 hour, remove the ice bath,

## Chapter 10: Preparation of Nerve Agents

and then remove the upper water layer using a separatory funnel. Thereafter, pour the bottom methylene chloride layer into a reflux apparatus, and gently reflux the mixture at about 60 Celsius while stirring for 1 hour. Afterwards, remove the heat source, and allow the reaction mixture to cool to room temperature. Then add the other 5 grams of the product obtained in step 1, 50 additional milliliters of methylene chloride, and then stir the mixture at room temperature for 15 minutes. Then add drop-wise, 5.4 grams of anhydrous pinacolyl alcohol over a sufficient time as to keep the reaction mixture around room temperature. During the addition, stir the reaction mixture. After the addition, continue to stir the reaction mixture at room temperature for about 1 hour, and then place the reaction mixture into a reflux apparatus, and reflux at 60 Celsius for 1 hour. Thereafter, filter-off any precipitated impurities, and then place the filtered reaction mixture into a rotary evaporator or vacuum distillation apparatus, and remove the methylene chloride solvent under mild vacuum. If vacuum apparatus is not available, remove the methylene chloride by distillation at 40 Celsius. **Note: The methylene chloride mixture can be used directly in chemical warfare operations, when disseminated properly.** When the methylene chloride solvent has been evaporated, remove the remaining residue, and place it into a clean vacuum distillation apparatus, and distil the soman at 84 Celsius under a vacuum of 15 millimeters of mercury to obtain a crude soman product. **Note: this crude soman product need not be purified for use in chemical warfare operations. Purification of the soman is only desired if the soman is to be mixed with other agents.**

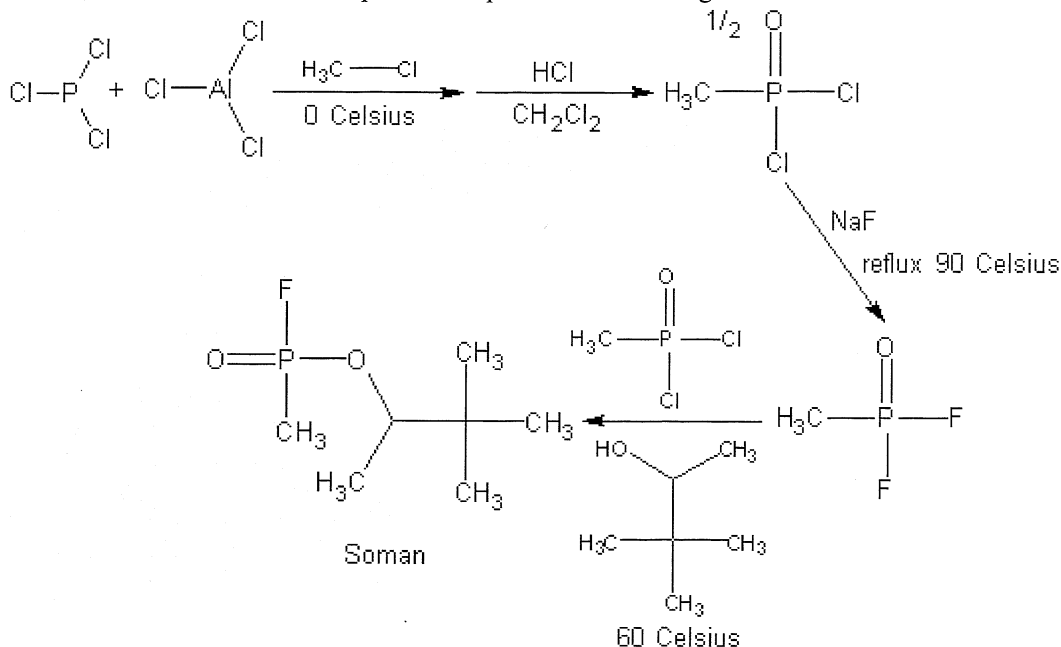
### Step 3: Purification

Setup the apparatus displayed in figure 046, thereafter prepare the silica gel with the following process: Pour 200 milliliters of distilled water into a suitable beaker, and then slowly pour in 30 grams of dry silica gel of 50 to 200 mesh while gradually stirring the mixture. After the addition of the silica gel, rapidly stir the mixture for 15 minutes, and thereafter, carefully decant-off the "fines". The fines are particles of matter that need to be removed to ensure a good flow rate. Then pour the silica gel into the glass column (make sure the glass column's stopcock is closed), as pictured in the following figure. Thereafter, pour in distilled water until the glass column is nearly full. Then gently open the stopcock, and drain off most of the water, until only about 10 centimeters of water remains above the silica gel layer. Then add 50 milliliters of dry isopropyl ether into the glass column, and then carefully drain-off the ether until most of it has passed through (by this time most of the water should have been removed). Thereafter, close the stopcock, and then add enough isopropyl ether into the glass column until the glass column is nearly full. Then, gently open the stopcock, and begin a very slow drip of the ether, and then at the same time, pour the crude soman product, obtained in step 2, into the glass column, and allow it to slowly pass through the glass column, drip by drip. Now when the total liquid layer is about 10 centimeters above the silica gel layer, close the stopcock. Immediately thereafter, remove the washing portion from the apparatus (remove the receiver flask at the bottom), and pour the contents into a clean beaker. Then replace said receiver flask with a clean one, and then pour enough fresh isopropyl ether into the glass column until the glass column is nearly full (make sure the stopcock is closed). Then open the stopcock to form a gentle drip, and then immediately add in the ether-washing portion (containing the soman) contained in the beaker into the glass column. Allow most of the ether to drain into the receiver flask. After which, remove the receiver flask from the apparatus, and then remove any water by placing the mixture into a separatory funnel, and draining off the bottom water layer. After any water has been removed, place the ether mixture into a clean rotary evaporator, and distill-off the isopropyl ether under mild vacuum. When all the ether has been removed, take out the remaining residue, and place into a clean vacuum distillation apparatus. Then vacuum distill the soman at 84 Celsius under a vacuum of 15 millimeters of mercury to obtain a purified soman product, well suitable for use in chemical warfare cocktails. **Note: instead of distilling-off the isopropyl ether, the ether mixture may be used in chemical warfare operations, and is actually preferred as a method of storing, preserving, and protecting the soman from decomposition. Mixtures of soman with ether, or methylene chloride can be effectively used to disseminate the soman in wartime operations. Mixtures of soman in a solvent such as methylene chloride or ether may persist up to two or three times longer than straight soman in wartime operations.**

### Procedure 04-011C: Preparation of Soman (modified sodium fluoride process)

**Summary:** Soman can be made using a modified process where by sodium fluoride is the fluorinating agent rather than the dangerous to handle hydrofluoric acid. The first step is the preparation of the already discussed methyl phosphonic dichloride. The second step is the preparation of the difluoride, which is accomplished by refluxing sodium fluoride with half of the methyl phosphonic dichloride. The resulting difluoride is then mixed with the other half of methyl phosphonic dichloride, and then treated with pinacolyl alcohol. The soman can then be purified using the usual methods.

Chapter 10: Preparation of Nerve Agents



*Reaction Equation (by-products omitted)*

<b>Materials:</b>	1. 10 grams of phosphorus trichloride	6. 3.1 grams of sodium fluoride
	2. 9.7 grams of anhydrous aluminum chloride	7. 5.4 grams pinacolyl alcohol
	3. 11 grams of methyl chloride	8. 30 grams of dry silica gel
	4. 146 milliliters of methylene chloride	9. 200+ milliliters of isopropyl ether
	5. 18.4 milliliters of 35 to 37% hydrochloric acid	10. 100 milliliters of toluene

**Hazards:**



**WARNING! WARNING! WARNING!**

Do not attempt in anyway to prepare soman using the following procedure unless proper safety precautions are taken. 1) Perform all operations in a clean box, which is treated with a nitrogen atmosphere, and in which is completely sealed from the air. 2) After each procedure, all glassware and non-electric equipment should be soaked in a bleach (sodium hypochlorite) solution before removing from the clean box. Any electrical equipment such as hot plates and stirring equipment should be carefully wiped down with a bleached soaked rag before removing from the clean box. 3) After the entire operation is complete, the entire clean box should be disinfected with bleach before opening the clean box to the air. 4) The desired soman product should be stored in amber bottles, preferably non-breakable containers, and stored in a cool dry place away from sunlight. The bottles should also be placed inside an airtight sealed plastic bag, such as a 'ziplock' bag. 5) Storage of any and all nerve agents should be in airtight cabinets, drawers, or the like, and said storage spaces should be equipped with chemical agent detection monitors to alert of any potential leakage. Use caution when handling methyl phosphonic dichloride, which is highly toxic, and can be absorbed through the skin causing mild nerve agent symptoms. Use care when handling phosphorus trichloride, and aluminum chloride, both of which can cause irritation of the skin and eyes, and both of which violently react with water evolving corrosive and toxic fumes. Avoid inhalation of toluene vapors, as they are potentially carcinogenic. Wear gloves when handling sodium fluoride, and avoid ingestion and skin absorption. Wear gloves when handling concentrated hydrochloric acid, and avoid inhalation of the vapors.

**Procedure:**

Step 1: Preparation of methyl phosphonic dichloride



## Chapter 10: Preparation of Nerve Agents

Place 10 grams of pure phosphorus trichloride, 9.7 grams of pure anhydrous aluminum chloride, and a lecture bottle of anhydrous methyl chloride into a freezer, and chill to 0 Celsius prior to the following: Into a suitable glass stoppered bottle, place 9.7 grams of cold anhydrous aluminum chloride, and then 10 grams of cold phosphorus trichloride. Shortly thereafter, transfer in 11 grams of liquid methyl chloride. Then, stopper the bottle, and then shake the bottle for 1 hour to dissolve all solids. Note: Use caution as heat of reaction may boil-off some of the liquid methyl chloride producing dangerous pressures. If need be, the liquid methyl chloride can be replaced by rapidly bubbling 11 grams of ice cold methyl chloride gas into the phosphorus trichloride/aluminum chloride mixture, followed by stoppering the flask, and then shaking for 1 hour to dissolve all solids. After 1 hour, stop shaking, and then place the stoppered flask into a freezer and chill at 0 Celsius for 24 hours. After 24 hours, filter-off the precipitated solid, and then allow it dry in a desiccator filled with anhydrous sodium sulfate. When the solid is thoroughly dry, dissolve it into 146 milliliters of methylene chloride, and then chill this mixture to 0 Celsius by use of an ice bath. Then, place 18.4 milliliters of cold 35 to 37% hydrochloric acid into an addition funnel, and then add this acid, drop wise (at the rate of 10 drops per minute), to the methylene chloride mixture. Stir the methylene chloride mixture thoroughly during the addition of the hydrochloric acid. After the addition of the hydrochloric acid, continue to stir the reaction mixture for 90 minutes, while keeping the temperature at 5 Celsius or lower during the whole time. After stirring for 2 hours, filter-off any insoluble impurities, and then remove the upper water layer using a separatory funnel. Thereafter, place the methylene chloride layer into a distillation apparatus, or rotary evaporator, and then remove the methylene chloride solvent under vacuum. Note: if vacuum apparatus is unavailable, carefully distilling-off the methylene chloride at 40 Celsius can be used. After the solvent has been removed, place the remaining material into a clean rotary evaporator, or vacuum distillation apparatus, and distil the methyl phosphonic dichloride at 28 millimeters of mercury to obtain a semi-solid colorless mass, or clear liquid of methyl phosphonic dichloride.

### Step 2: Preparation of soman

Too 10 grams of the product obtained in step 1, place 5 grams of it into a suitable flask, and then add 100 milliliters of toluene. Thereafter, add 3.1 grams of anhydrous sodium fluoride and then begin rapidly stirring the mixture. Then place the mixture into a reflux apparatus and reflux the mixture at 90 Celsius for 1 hour. After refluxing for 1 hour, remove the heat source, and then allow the reaction mixture to cool to room temperature. Thereafter, filter the reaction mixture to remove any insoluble impurities, and then place the filtered reaction mixture into a rotary evaporator, and evaporate-off the toluene under vacuum. When all the toluene has been removed, remove the remaining residue, and then place said residue into a clean flask, and then add 100 milliliters of methylene chloride, followed by the other 5 grams of the product obtained in step 1. Note: stir the mixture thereafter to dissolve the residue into the methylene chloride. Then add drop wise, 5.4 grams of anhydrous pinacolyl alcohol over a period of about 5 minutes, while stirring the reaction mixture and maintaining the reaction mixtures temperature at room temperature. After the addition of the isopropyl alcohol, continue to stir the reaction mixture for 1 hour at room temperature. Thereafter, reflux the reaction mixture at 60 Celsius for 1 hour while stirring. After the reflux period, remove the heat source and allow the reaction mixture to cool to room temperature. Then filter the reaction mixture to remove any insoluble impurities, and then place the filtered reaction mixture into a rotary evaporator and evaporate-off the methylene chloride under mild vacuum. If vacuum apparatus is unavailable, distill-off the methylene chloride at 40 Celsius. **Note: The methylene chloride mixture can be used directly in chemical warfare operations, when disseminated properly.** When the methylene chloride has been removed, remove the remaining residue and place into a clean vacuum distillation apparatus, and distill the soman at 84 Celsius under a vacuum of 15 millimeters of mercury to obtain a crude soman product. **Note: this crude soman product need not be purified for use in chemical warfare operations. Purification of the soman is only desired if the soman is to be mixed with other agents.**

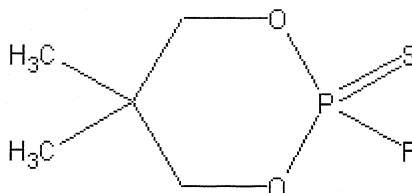
### Step 3: Purification

Setup the apparatus displayed in figure 046, thereafter prepare the silica gel with the following process: Pour 200 milliliters of distilled water into a suitable beaker, and then slowly pour in 30 grams of dry silica gel of 50 to 200 mesh while gradually stirring the mixture. After the addition of the silica gel, rapidly stir the mixture for 15 minutes, and thereafter, carefully decant-off the "fines". The fines are particles of matter that need to be removed to ensure a good flow rate. Then pour the silica gel into the glass column (make sure the glass column's stopcock is closed), as pictured in the following figure. Thereafter, pour in distilled water until the glass column is nearly full. Then gently open the stopcock, and drain off most of the water, until only about 10 centimeters of water remains above the silica gel layer. Then add 50 milliliters of dry isopropyl ether into the glass column, and then carefully drain-off the ether until most of it has passed through (by this time most of the water should have been removed). Thereafter, close the stopcock, and then add enough isopropyl ether into the glass column until the glass column is nearly full. Then, gently open the stopcock, and begin a very slow drip of the ether, and then at the same time, pour the crude sarin product, obtained in step 2, into the glass column, and allow it to slowly pass through the glass column, drip by drip. Now when the total liquid layer is about 10 centimeters above the silica gel layer, close the stopcock. Immediately thereafter, remove the washing portion from the apparatus (remove the receiver flask at the bottom), and pour the contents into a clean beaker. Then replace said receiver flask with a clean one, and then pour enough fresh isopropyl ether into the glass column until the glass column is nearly full (make sure the stopcock is closed). Then open the stopcock to form a gentle drip, and then immediately add in the ether-washing portion (containing the soman) contained in the beaker into the glass column. Allow most of the ether to drain into the receiver flask. After which, remove the receiver flask from the apparatus, and then remove



any water by placing the mixture into a separatory funnel, and draining off the bottom water layer. After any water has been removed, place the ether mixture into a clean rotary evaporator, and distill-off the isopropyl ether under mild vacuum. When all the ether has been removed, take out the remaining residue, and place into a clean vacuum distillation apparatus. Then vacuum distill the soman at 84 Celsius under a vacuum of 15 millimeters of mercury to obtain a purified soman product, well suitable for use in chemical warfare cocktails. **Note: instead of distilling-off the isopropyl ether, the ether mixture may be used in chemical warfare operations, and is actually preferred as a method of storing, preserving, and protecting the soman from decomposition. Mixtures of soman with ether, or methylene chloride can be effectively used to disseminate the soman in wartime operations. Mixtures of soman in a solvent such as methylene chloride or ether may persist up to two or three times longer than straight soman in wartime operations.**

#### 04-012. NPSF. Neopentylene thiophosphorus fluoridate; *Neopentylene fluorophosphonothioate*



NPSF

NPSF is a colorless liquid with a boiling point of 173 Celsius at 760 millimeters of mercury. It can be distilled at 54 Celsius under a vacuum of 10 millimeters of mercury. Impure NPSF may be a waxy to semi-solid mass or brownish to amber colored liquid. The odor of pure NPSF is probably odorless, but as with other nerve agents it probably has a slight odor of fruit or thiol like odor when impure. The toxicity of NPSF is probably similar to NPF, along with its environmental persistence, but it may be more toxic and persistent than NPF. It can probably remain in the environment for up to 7 days or more, depending on conditions, and has found to be very effective when admixed with other agents such as sarin, or soman. Since the stability of NPSF is greater than sarin, soman, or tabun, its effectiveness in military operations is quite high especially when mixed with sarin, or soman. Another potential use of NPSF is as an additive with blister agents of the nitrogen mustard class. In cocktails with nitrogen mustards, NPSF can demonstrate extremely effective battlefield use. Mixtures of NPSF with nitrogen mustards can contaminate tactical areas for up to 4 to 9 days. Any exposed personnel within such contaminated areas may suffer from dangerous nerve agent effects days or even weeks after contact with said environments. This delayed effect is the result of the exposed personnel coming into contact with said blister agents, which cause delayed illness. During this delayed entry of illness, the NPSF nerve agent is undergoing its process of body penetration. After body penetration, the exposed personnel can suffer from a numerous array of illnesses for periods of months to even years. NPSF can be disseminated using aerosols, explosives munitions, atomizers or humidifiers, or foggers. **NPSF is a mild, delayed action casualty producing nerve agent. Effects of exposure may not be recognized until days after exposure. The lethal dose for the average man is probably relatively high, anywhere from 1800 micrograms to 8,000 micrograms through inhalation, but the incapacitating effects of this agent, although delayed, may inflict illness to those contaminated for month's even years after exposure. The average incapacitating dose ranges from 50 to 800 micrograms.**

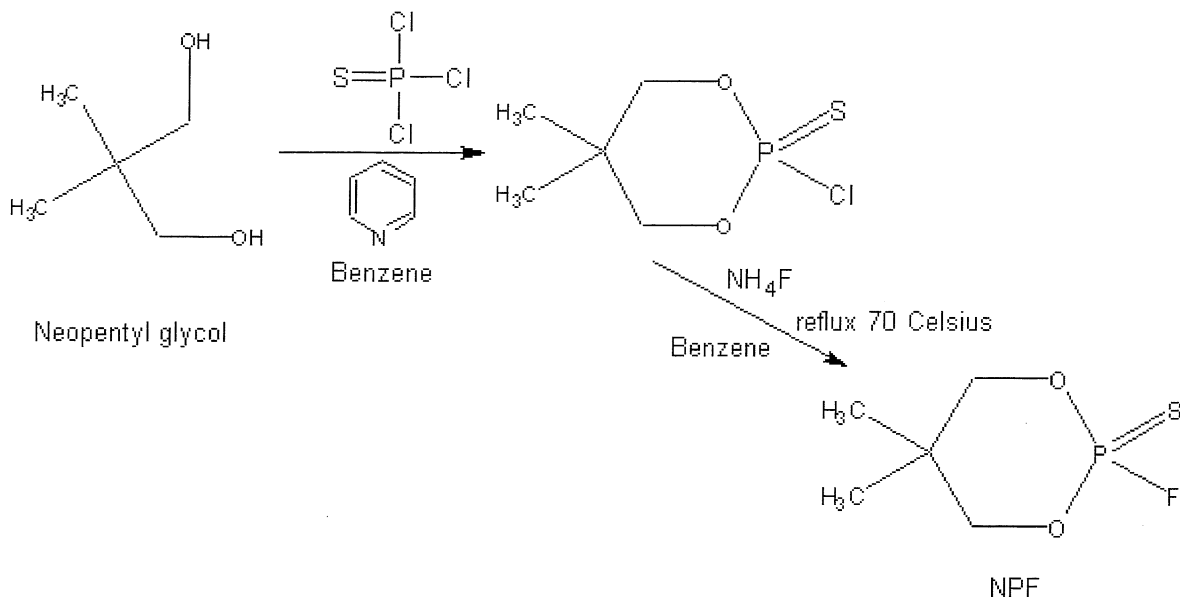
OVERALL RATING (scale from 1 to 10)	
<i>Effectiveness (as nerve agent): 7</i>	<i>Field Stability: 9</i>
<i>Persistence (open area): 8</i>	<i>Storage stability: 8</i>
<i>Persistence (enclosed area): 8</i>	<i>Toxicity (as nerve agent): 7</i>
<b>TOTAL EFFECTIVENESS (as nerve agent): 7.8</b>	
<b>OVERALL TOXICITY (as warfare agent): 6½</b>	

#### Procedure 04-012A: Preparation of NPSF

**Summary:** NPSF can be made in a simple two-step process starting with the formation of neopentylene chlorophosphonylthioate. This chlorophosphonylthioate intermediate is simply prepared by reacting thiophosphorus trichloride with neopentyl glycol in the presence of benzene. Pyridine is added along with the neopentyl glycol to act as a hydrogen chloride scavenger. The resulting reaction mixture is then stirred for 12 hours, filtered, to remove the insoluble pyridine hydrochloride (which can be recycled by mixing with sodium carbonate), and then evaporated to yield a dry solid. The dry solid is then recrystallized from hot petroleum ether. The resulting neopentylene chlorophosphonylthioate is then converted into NPSF by reaction with anhydrous ammonium fluoride in benzene under reflux conditions. The resulting reaction mixture is then refluxed for additional time, and then stirred overnight. The resulting mixture is then filtered, evaporated, and then distilled to obtain the refined NPSF product. Note: The preparation of

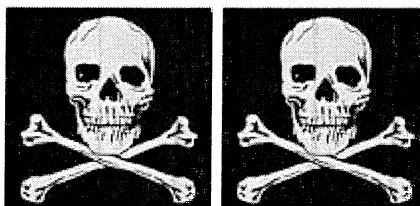
Chapter 10: Preparation of Nerve Agents

neopentylene chlorophosphate discussed in step 1, is similar or related to the process discussed in serial number 274,336, April 19<sup>th</sup>, 1963 by Marcel A. Gradsten, of Demarest, NJ, assigned by Mesne assignments to Tenneco Chemicals, Inc. This process may be protected by industrial/commercial process applications. Consult said application number before using the mentioned process for commercial or industrial purposes.



<b>Materials:</b>	1. 85 grams of thiophosphorus trichloride	4. 79 grams of pyridine
	2. 696 milliliters of benzene	5. 200 milliliters of petroleum ether
	3. 52 grams of neopentyl glycol	6. 18 grams of anhydrous ammonium fluoride

**Hazards:**



**WARNING! WARNING!**

Do not attempt in anyway to prepare NPSF using the following procedure unless proper safety precautions are taken. 1) Perform all operations in a clean box, which is treated with a nitrogen atmosphere, and in which is completely sealed from the air. 2) After each procedure, all glassware and non-electric equipment should be soaked in a bleach (sodium hypochlorite) solution before removing from the clean box. Any electrical equipment such as hot plates and stirring equipment should be carefully wiped down with a bleached soaked rag before removing from the clean box. 3) After the entire operation is complete, the entire clean box should be disinfected with bleach before opening the clean box to the air. 4) The desired NPSF product should be stored in amber bottles, preferably non-breakable containers, and stored in a cool dry place away from sunlight. The bottles should also be placed inside an airtight sealed plastic bag, such as a 'ziplock' bag. 5) Storage of any and all nerve agents should be in airtight cabinets, drawers, or the like, and said storage spaces should be equipped with chemical agent detection monitors to alert of any potential leakage. Use caution when handling neopentylene chlorophosphonylthioate, which is highly toxic and can be absorbed through the skin. Use caution when handling thiophosphorus oxytrichloride, which reacts with water producing toxic fumes. Benzene is a suspected carcinogen, so handle with care.

**Procedure:**

**Step 1: Preparation of neopentylene chlorophosphonylthioate**

Into a suitable flask, place 85 grams of thiophosphorus trichloride, followed by 350 milliliters of benzene. Thereafter, place this mixture into a cold-water bath, and chill to 10 to 13 Celsius. Thereafter, slowly add, drop wise, over a period of about 45 minutes, a solution prepared by adding and dissolving 52 grams of neopentyl glycol, and 79 grams of pyridine into 100 milliliters of benzene.

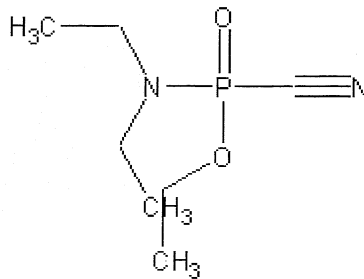
## Chapter 10: Preparation of Nerve Agents

During the addition, vigorously stir the reaction mixture and maintain its temperature around 10 to 13 Celsius. After the addition, remove the cold-water bath, and allow the reaction mixture to warm to room temperature. Thereafter, continue to stir the reaction mixture for 12 hours at room temperature. After 12 hours, filter-off any insoluble materials, and then wash the filtered-off materials with one 50 milliliter portion of benzene (using the same washing portion), and then wash the filtered-off materials once with a 25 milliliter portion of benzene. Then add the 50-milliliter and 25-milliliter washing portions of benzene to the reaction mixture, and then place the total reaction mixture into a rotary evaporator or vacuum distillation apparatus, and remove the toluene under vacuum. After the benzene is removed, a light brown solid will remain. Then take this light brown solid, and then dissolve it into 200 milliliters of hot petroleum ether. After which, a small amount of an oily residue will form; thereafter, remove the oily residue by decantation, and then allow the hot petroleum ether solution to cool to room temperature. Then place the petroleum ether mixture into an ice bath, and allow it to stand for several hours. Thereafter, filter-off the precipitated product, wash with the cold petroleum ether liquid, and then vacuum dry or air-dry the product. The dry product will be about 81 grams. The remaining petroleum ether can be evaporated to yield about 5 grams of additional product, which can then be recovered and dried.

### Step 2: Preparation of NPSF

Into a suitable flask, add 50 grams of the product obtained in step 1, and then add 50 milliliters of benzene. Then stir the mixture to dissolve all solids. Then prepare a solution by adding and dissolving 18 grams of anhydrous ammonium fluoride into 121 milliliters of benzene. Then place this ammonium fluoride mixture into a reflux apparatus, and begin refluxing at 70 Celsius with stirring. When the temperature of the ammonium fluoride mixture reaches 70 Celsius, slowly add drop wise, the benzene solution containing the product obtained in step 1 over a period of about 20 minutes while stirring the reaction mixture and maintaining its temperature under reflux at 70 Celsius. After the addition, continue to stir the reaction mixture for 2 hours at 70 Celsius with constant stirring. After stirring for 2 hours, remove the heat source, and allow the reaction mixture to cool to room temperature, and then allow the reaction mixture to stand at room temperature for 12 hours. 12 hours later, filter-off any insoluble impurities, and then place the filtered reaction mixture into a rotary evaporator or vacuum distillation apparatus, and remove the benzene solvent at 60 Celsius under vacuum. After the benzene has been removed, remove the remaining residue, and then place into a clean vacuum distillation apparatus, and distill the product at 54 Celsius under a vacuum of 10 millimeters of mercury to obtain a refined NPSF product.

### 04-013. Tabun-II. GAA. *Diethylamidoethoxyphosphoryl cyanide; N-Diethylphosphoramidocyanidate*



Tabun-II

Currently there is little data on Tabun-II. Tabun-II is a colorless to light yellow or brown viscous oily liquid with a boiling point of 270 to 280 Celsius. It probably begins to decompose when heated to 150 Celsius, but it can be distilled at 123 Celsius under a vacuum of 5 millimeters of mercury. Impure tabun-II may be a dirty colored solid, or semi-solid viscous liquid. Tabun-II has similar properties to tabun because of its resembling structure; two ethyl groups rather than two methyl groups. Tabun-II is readily soluble in water (303 grams per liter), and it is very soluble in the usual organic solvents, and oils. Its persistence and stability in water would be greater than for tabun. Its stability in water would be 48 to 72 hours under normal conditions. Its persistence in the environment would be satisfactory, and it may possess a greater threat than original tabun. Tabun-II could be used as an effective substitute for tabun, sarin, or soman for military operations. It can be disseminated by aerosols, smoke generating munitions, explosives munitions, or foggers. **Tabun-II is a fast acting casualty producing nerve agent capable of causing casualties within minutes of dissemination. The lethal dose for the average man is probably around 1 to 2 milligrams per person by inhalation. Tabun-II is highly toxic through ingestion, inhalation, and skin and eye absorption.**

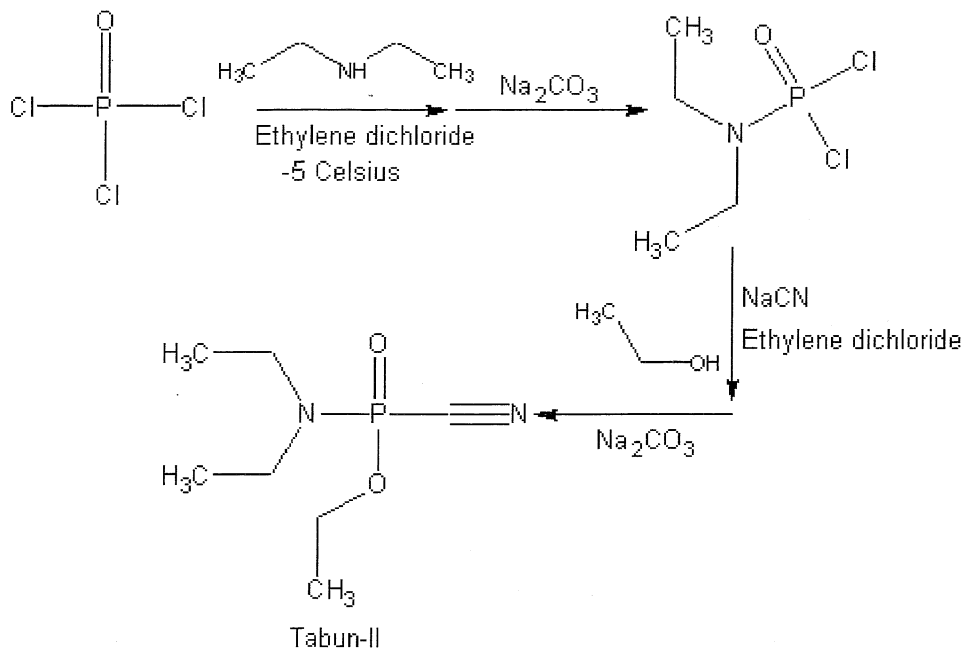
OVERALL RATING (scale from 1 to 10)	
<i>Effectiveness (as nerve agent):</i> 7¾	<i>Field Stability:</i> 8
<i>Persistence (open area):</i> 8	<i>Storage stability:</i> 8
<i>Persistence (enclosed area):</i> 9	<i>Toxicity (as nerve agent):</i> 7¾

TOTAL EFFECTIVENESS (as nerve agent): 8

OVERALL TOXICITY (as warfare agent): 7½

## Procedure 04-013A: Preparation of Tabun-II

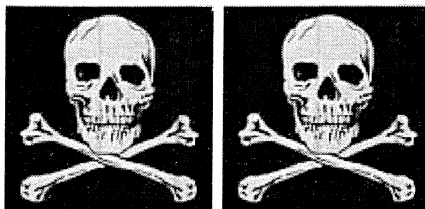
**Summary:** This process is identical to the preparation of tabun. Tabun-II is readily prepared using a two-step process starting with the preparation of diethylamido phosphoryl dichloride. The dichloride intermediate is prepared by reacting diethylamine with phosphorus oxytrichloride in ethylene dichloride solvent. The resulting amine hydrochloride salt is then simultaneously decomposed to the diethylamido phosphoryl dichloride by the addition of sodium carbonate. The diethylamido phosphoryl dichloride is then converted into tabun-II by reaction with sodium cyanide and ethyl alcohol in acetonitrile, followed by neutralization of the amine salt with sodium carbonate. The resulting reaction mixture is then stripped of solvent, and the remaining residue distilled to obtain refined tabun-II. Note: The preparation of diethylamido phosphoryl dichloride discussed in step 1, is similar or related to the processes discussed in serial number 281,886 April 11<sup>th</sup>, 1952 by George A. Saul and Kenneth L. Godfrey, both of Virginia, assigned by Monsanto Chemical Company. This process may be protected by industrial/commercial process applications. Consult said application number before using the mentioned process for commercial or industrial purposes.



## Reaction Equation (by-products omitted)

<b>Materials:</b>	1. 55 grams of phosphorus oxytrichloride	5. 5.1 grams of anhydrous sodium cyanide
	2. 350 grams of ethylene dichloride	6. 4.8 grams anhydrous ethyl alcohol (200 proof)
	3. 26 grams of anhydrous diethylamine	7. 60 milliliters of acetonitrile
	4. 19 grams of anhydrous sodium carbonate	

## Hazards:

**WARNING! WARNING!**

Do not attempt in anyway to prepare tabun-II using the following procedure unless proper safety precautions are taken. 1) Perform all operations in a clean box, which is treated with a nitrogen atmosphere, and in which is completely sealed from the air. 2) After each procedure, all glassware and non-electric equipment should be soaked in a bleach (sodium hypochlorite) solution before removing from the clean box. Any electrical equipment such as hot plates and stirring equipment should be carefully wiped down with a bleached soaked rag before removing from the

## Chapter 10: Preparation of Nerve Agents

clean box. 3) After the entire operation is complete, the entire clean box should be disinfected with bleach before opening the clean box to the air. 4) The desired tabun-II product should be stored in amber bottles, preferably non-breakable containers, and stored in a cool dry place away from sunlight. The bottles should also be placed inside an airtight sealed plastic bag, such as a 'ziplock' bag. 5) Storage of any and all nerve agents should be in airtight cabinets, drawers, or the like, and said storage spaces should be equipped with chemical agent detection monitors to alert of any potential leakage.

Use caution when handling diethylamido phosphoryl dichloride, which may cause nerve agent like symptoms if ingested or inhaled. Wear gloves when handling sodium cyanide, and acetonitrile, both of which can be absorbed by the skin leading to toxic results. Ethanol is flammable, so extinguish all flames before using. Use care when handling diethylamine, which is also flammable, and an irritant.

### Procedure:

#### Step 1: Preparation of diethylamido phosphoryl dichloride

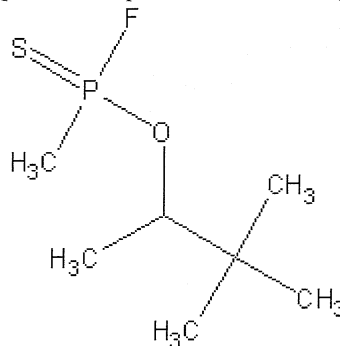
Into a suitable flask, place 55 grams of phosphorus oxytrichloride, and then 300 grams of ethylene dichloride. Thereafter, place the mixture into a salt/ice bath, and chill to  $-5$  Celsius. When the temperature of mixture reaches  $-5$  Celsius, slowly add drop wise, 26 grams of anhydrous diethylamine while stirring the reaction mixture and maintaining its temperature at  $-5$  Celsius. After the addition of the diethylamine, add in 19 grams of anhydrous and powdered sodium carbonate. During the addition, stir the reaction mixture, and maintain its temperature at  $-5$  Celsius. After the addition of the sodium carbonate, continue to stir the reaction mixture for 30 minutes at  $-5$  Celsius. Thereafter, filter-off any insoluble impurities, and then wash these filtered-off impurities several times with a single washing portion of ethylene dichloride (50 grams). After the washing, combine the 50-gram portion of ethylene dichloride with the filtered reaction mixture, and then place the reaction mixture into a rotary evaporator or vacuum distillation apparatus, and remove the ethylene dichloride solvent under vacuum. After the ethylene dichloride solvent has been removed, place the remaining residue into a clean vacuum distillation apparatus, and fractionally distill the product under high vacuum and under a temperature of 110 Celsius to obtain a good yield of diethylamido phosphoryl dichloride.

#### Step 2: Preparation of tabun-II

Into a suitable flask, add 180 grams of ethylene dichloride, and then 20 grams of the product obtained in step 1. Thereafter, thoroughly blend the mixture to dissolve all solids. Then prepare a solution by adding and dissolving 5.1 grams of finely powdered anhydrous sodium cyanide into 60 milliliters of acetonitrile, and thereafter, add and dissolve 4.8 grams of anhydrous ethyl alcohol there into. Then place the flask containing the ethylene dichloride mixture into an ice bath, and chill to 0 Celsius. Thereafter, slowly add drop-wise, the sodium cyanide/acetonitrile/ethyl alcohol solution, to the ethylene dichloride mixture while vigorously stirring the ethylene dichloride mixture and keeping its temperature around 0 Celsius. After the addition, continue to vigorously stir the reaction mixture for 1 hour at 0 Celsius, after which, remove the ice bath, and then reflux the entire reaction mixture for 90 minutes at 84 Celsius with vigorous stirring. After 90 minutes, remove the heat source, and allow the reaction mixture to cool to room temperature. Then place the reaction mixture into an ice water bath, and chill to 5 Celsius. Then gradually add in portions, 6 grams of anhydrous powdered sodium carbonate to the reaction mixture, and then vigorously stir the reaction at room temperature for 30 minutes. Afterwards, filter-off any insoluble impurities, and then place the reaction mixture into a rotary evaporator, or vacuum distillation apparatus, and remove the ethylene dichloride solvent, and acetonitrile solvent under vacuum. Note: These two solvents can be collected in the same receiver flask, and separated later, or fractionally distilled using two different angled liebig condensers. After the ethylene dichloride and acetonitrile solvents have been removed, remove the remaining residue, and place into a clean vacuum distillation apparatus, and fractionally distill the tabun-II at 123 Celsius under a vacuum of 5 millimeters of mercury to obtain a refined tabun-II product. Purification can be accomplished by using a silica gel column filled with aluminum oxide, and using methylene chloride solvent. **Note: The refined tabun-II product can be dissolved in methylene chloride, ether, or any desired solvent, and used as such in chemical warfare operations when properly disseminated.**

### **04-014. ThioSoman. GDS. ThioTrilon. Pinacolyl methylthiophosphorusfluoridate;** *Methylthiophosphorusfluoridic acid 1,2,2-tri-methylpropyl ester.*

Chapter 10: Preparation of Nerve Agents



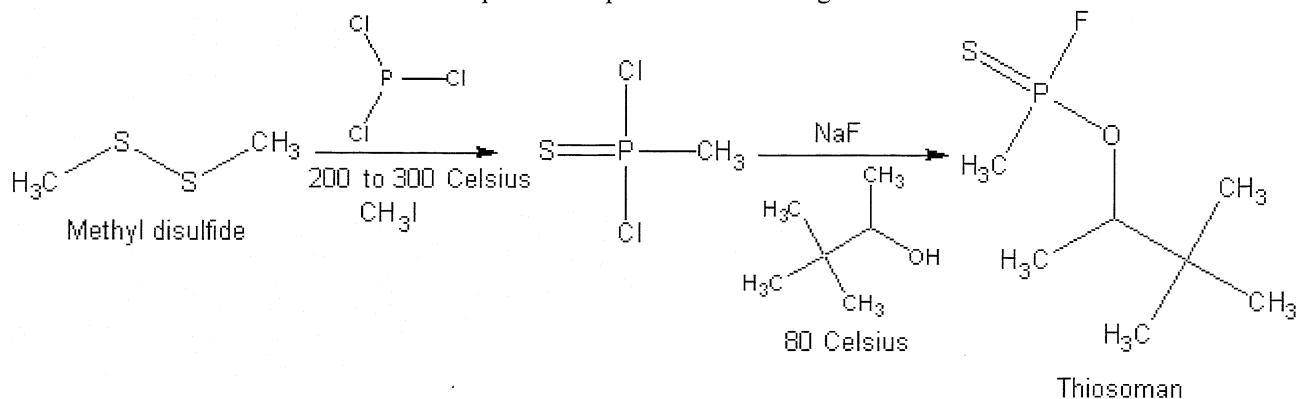
Thiosoman

Very little data was obtainable on thiosoman, but it is a liquid, most likely colorless when pure and lightly colored when impure. It has a boiling point of 200 to 220 celsius at 760 millimeters of mercury, and it can be distilled at 76 Celsius under 10 millimeters of mercury. It probably has no odor, but impure thiosoman probably has an odor similar to impure thiosarin with a possible fruity to rotten-fruity odor. Through simple observation it is evident that thiosoman would have greater environmental persistence than thiosarin, and would have a greater half-life than thiosarin due to the sulfur-phosphorus bond, and the greater molecular weight. The phosphorus-fluorine bond would probably show some hydrolysis effect with water, but to a lesser extent than for thiosarin. Thiosoman is almost entirely insoluble in water. It is safe to assume that thiosoman would have similar toxicity as that of thiosarin. Thiosoman would probably be more biologically active than thiosarin, making it more effective as a "nerve agent". The potential for thiosoman as an effective nerve agent is probable. Note: Certain biological studies have shown that thiosoman is more toxic than soman. It can be disseminated using aerosols, explosives munitions, atomizers or humidifiers, or foggers. **Thiosoman is a moderately fast acting nerve agent capable of producing casualties within 12 hours of dissemination or exposure by personnel. The lethal dose for the average man is probably about 800 micrograms to 1500 micrograms by inhalation. Thiosoman is highly toxic through ingestion, inhalation, and skin and eye absorption.**

OVERALL RATING (scale from 1 to 10)	
<i>Effectiveness (as nerve agent): 7</i>	<i>Field Stability: 8</i>
<i>Persistence (open area): 9</i>	<i>Storage stability: 8</i>
<i>Persistence (enclosed area): 9</i>	<i>Toxicity (as nerve agent): 7¾</i>
<b>TOTAL EFFECTIVENESS (as nerve agent): 8.1</b>	
<b>OVERALL TOXICITY (as warfare agent): 7¾</b>	

**Procedure 04-014A: Preparation of Thiosoman**

**Summary:** Thiosoman is prepared in a two-step process starting with the formation of methyl thiophosphorus dichloride. The thiophosphorus dichloride is prepared by thermally reacting phosphorus trichloride with methyl disulfide under heat and pressure. The resulting thiophosphorus dichloride is then recovered by fractional distillation under vacuum. In this procedure, there are included two methods of preparing methyl thiophosphorus dichloride (step 1B is a modified process utilizing a methyl iodide catalyst). The thiosoman is then easily prepared by reacting the methyl thiophosphorus dichloride with sodium fluoride and isopropyl alcohol in toluene. Recovery of the thiosoman is accomplished by vacuum distillation using the normal techniques. Note: The preparation of methyl thiophosphorus dichloride discussed in step 1A and step 1B, is similar or related to the process discussed in serial number 515,754 December 22<sup>nd</sup>, 1965 by Joseph W. Baker of Kirkwood Missouri; Raymond E. Stenseth of St. Louise Missouri, assigned by Monsanto Company. This process may be protected by industrial/commercial process applications. Consult said application number before using the mentioned process for commercial or industrial purposes.



<b>Materials:</b>	1. 274.8 grams of phosphorus trichloride	6. 50 milliliters of toluene
	2. or 76 grams of phosphorus trichloride	7. 10.3 grams of anhydrous pinacolyl alcohol
	3. 190.2 grams of methyl disulfide	8. 4.2 grams of anhydrous sodium fluoride
	4. or 54 grams of methyl disulfide	
	5. 4.6 grams of methyl iodide	

**Hazards:****WARNING! WARNING! WARNING!**

Do not attempt in anyway to prepare thiosoman using the following procedure unless proper safety precautions are taken. 1) Perform all operations in a clean box, which is treated with a nitrogen atmosphere, and in which is completely sealed from the air. 2) After each procedure, all glassware and non-electric equipment should be soaked in a bleach (sodium hypochlorite) solution before removing from the clean box. Any electrical equipment such as hot plates and stirring equipment should be carefully wiped down with a bleached soaked rag before removing from the clean box. 3) After the entire operation is complete, the entire clean box should be disinfected with bleach before opening the clean box to the air. 4) The desired thiosoman product should be stored in amber bottles, preferably non-breakable containers, and stored in a cool dry place away from sunlight. The bottles should also be placed inside an airtight sealed plastic bag, such as a 'ziplock' bag. 5) Storage of any and all nerve agents should be in airtight cabinets, drawers, or the like, and said storage spaces should be equipped with chemical agent detection monitors to alert of any potential leakage.

Use caution when handling methyl thiophosphorus dichloride, which is highly toxic, and can be absorbed through the skin causing mild nerve agent symptoms. Use care when handling phosphorus trichloride, which can cause irritation of the skin and eyes, and which violently reacts with water evolving corrosive and toxic fumes. Avoid inhalation of toluene vapors, as they are potentially carcinogenic. Wear gloves when handling sodium fluoride, and avoid ingestion and skin absorption.

**Procedure:****Step 1A: Preparation of methyl thiophosphorus dichloride (method 1)**

Into a pressure vessel (as shown in figure 047), place 190.2 grams of methyl disulfide, and then 274.8 grams of phosphorus trichloride. Thereafter seal the pressure vessel, and heat the ingredients in the pressure vessel to 275 Celsius. Continue to heat the ingredients in the pressure vessel at 275 Celsius for 12 hours. Note: Read your pressure vessel operators manual thoroughly before using such pressure vessel. Pressures vessels can lead to dangerous explosions if not used properly. After heating for 12 hours, remove the heat source, and allow the reaction mixtures ingredients to cool to room temperature. Thereafter, open the pressure vessel (use caution, as great pressure will be relieved; mostly in the form of gaseous methyl chloride by-product). After opening the pressure vessel, remove

the contents there from, and place into a clean vacuum distillation apparatus, and fractionally distill the product at 70 Celsius under a vacuum of 50 millimeters of mercury to obtain the methyl thiophosphorus dichloride.

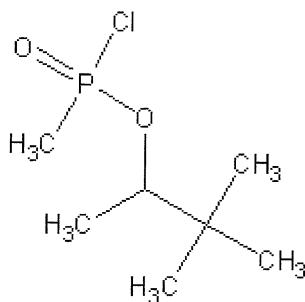
Step 1B: Modified preparation for methyl thiophosphorus dichloride (this step can be used in place of step 1A for the preparation of methyl thiophosphorus dichloride)

Into a pressure vessel (as shown in figure 047), place 54 grams of methyl disulfide, then 76 grams of phosphorus trichloride, and then add 4.6 grams of methyl iodide. Thereafter seal the pressure vessel, and heat the ingredients in the pressure vessel to 260 Celsius. Continue to heat the ingredients in the pressure vessel at 260 Celsius for 8 hours. Note: Read your pressure vessel operators manual thoroughly before using such pressure vessel. Pressures vessels can lead to dangerous explosions if not used properly. After heating for 8 hours, remove the heat source, and allow the reaction mixtures ingredients to cool to room temperature. Thereafter, open the pressure vessel (use caution, as great pressure will be relieved; mostly in the form of gaseous methyl chloride by-product). After opening the pressure vessel, remove the contents there from, and place into a clean vacuum distillation apparatus, and fractionally distill the product at 70 Celsius under a vacuum of 50 millimeters of mercury to obtain the methyl thiophosphorus dichloride.

Step 2: Preparation of thiosoman

Into a suitable flask, place 50 milliliters of toluene, and then add 4.2 grams of anhydrous sodium fluoride. Thereafter, add 10.3 grams of anhydrous pinacolyl alcohol, and then stir the mixture at room temperature for several minutes. Then heat the mixture to about 80 Celsius under reflux, and then carefully add portion-wise, 15 grams of the product obtained in step 1A or step 1B. During the addition, stir the reaction mixture and maintain its temperature at 80 Celsius. After the addition, continue to heat the reaction mixture at 80 Celsius, and continue stirring for an additional 60 minutes. After heating and stirring for 60 minutes, remove the heat source, and allow the reaction mixture to cool to room temperature. Then filter-off any insoluble impurities, and then place the filtered reaction mixture into a rotary evaporator or vacuum distillation apparatus and remove the toluene under vacuum. When all the toluene has been removed, remove the remaining residue, and place into a clean vacuum distillation apparatus, and distill the thiosoman at 76 Celsius under 10 millimeters of mercury to obtain a refined thiosoman product. Purification, if desired, may be carried out by using a silica gel column filled with aluminum oxide, or silica.

#### 04-015. ChloroSoman. GDCl. ChloroTrilon. Pinacolyl methylchlorophosphonylfluoridate; *Methylchlorophosphonylfluoridic acid 1,2,2-tri-methylpropyl ester*.



Chlorosoman

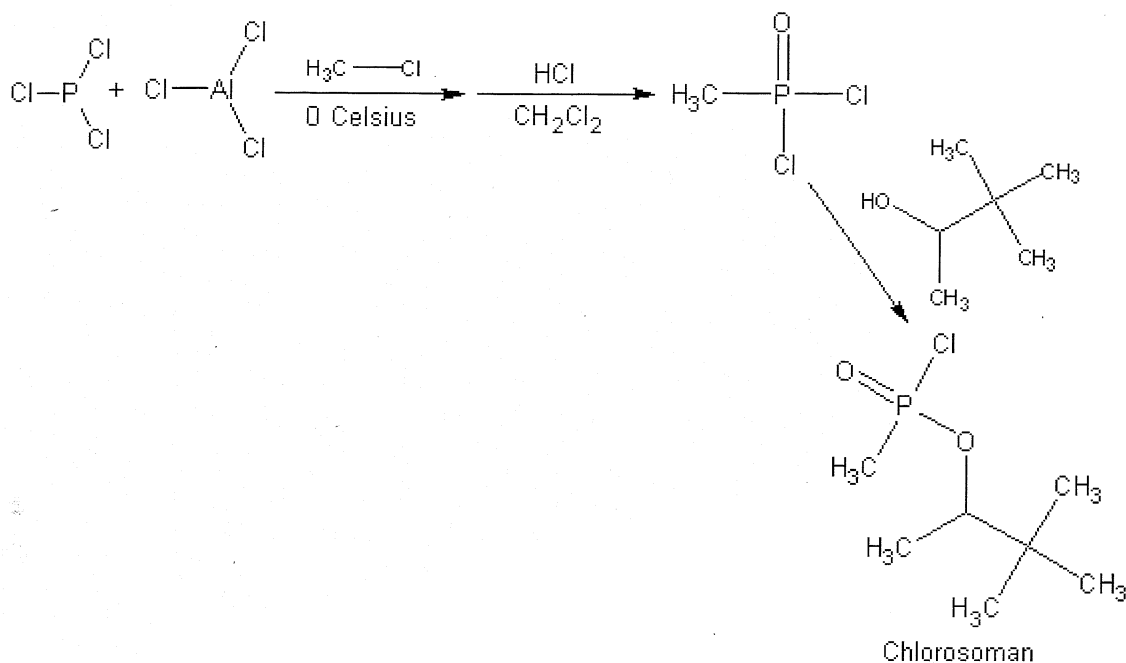
Chlorosoman is a colorless liquid with a boiling point of 200 to 240 Celsius at 760 millimeters of mercury. It may begin to disassociate at 140 Celsius, but can be distilled at 89 Celsius under a vacuum of 7 millimeters of mercury. Its properties are similar to chlorosarin, with similar decomposition rates. The persistence of chlorosoman is probably similar to soman, but only slightly less volatile. Very little data exists on this substance so exact numbers are unknown. It is safe to say that chlorosoman has a slight greater persistence than soman, but may be more prone to hydrolysis. Chlorosoman is soluble in water, but soluble in the usual organic solvents. The use of chlorosoman in wartime would most likely not be seen, but it can be used to train military troops, and to calibrate chemical agent detection systems. Chlorosoman produces the usual nerve agent symptoms, but with less lethality than soman. It can be disseminated using aerosols, explosives munitions, atomizers or humidifiers, or foggers. **Chlorosoman is a delayed action casualty producing agent, capable of producing casualties within 48 hours of dissemination or exposure by personnel. Lethal dose for the average man is probably 2 to 12 milligrams by inhalation. Chlorosoman is highly toxic through ingestion, inhalation, and skin and eye absorption.**

OVERALL RATING (scale from 1 to 10)	
<i>Effectiveness (as nerve agent):</i> 5	<i>Field Stability:</i> 7
<i>Persistence (open area):</i> 7	<i>Storage stability:</i> 8

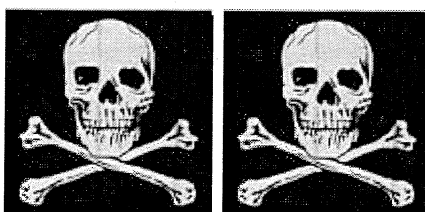


*Persistence (enclosed area): 8**Toxicity (as nerve agent): 6***TOTAL EFFECTIVENESS (as nerve agent): 6.8****OVERALL TOXICITY (as warfare agent): 6****Procedure 04-015A: Preparation of Chlorosoman**

**Summary:** Chlorosoman is easily prepared in a two-step process starting with the preparation of methyl phosphonic dichloride. The methyl phosphonic dichloride is easily made by reacting methyl chloride, and phosphorus trichloride in the presence of anhydrous aluminum chloride to form an insoluble complex. This insoluble complex is then recovered by filtration, dissolved in suitable solvent, and then hydrolyzed with concentrated hydrochloric acid. The hydrolyzed product is the methyl phosphonic dichloride. The methyl phosphonic dichloride is then carefully treated with pinacolyl alcohol to yield chlorosoman.

*Reaction Equation (by-products omitted)*

<b>Materials:</b>	1. 20 grams of phosphorus trichloride	6. 15.2 grams of anhydrous pinacolyl alcohol
	2. 19.4 grams of anhydrous aluminum chloride	7. 40 grams of toluene
	3. 22 grams of methyl chloride	8. 10 grams of pyridine
	4. 292 milliliters of methylene chloride	9. 5 grams of anhydrous calcium chloride
	5. 36.8 milliliters of 35 to 37% hydrochloric acid	

**Hazards:****WARNING! WARNING!**

Do not attempt in anyway to prepare chlorosoman using the following procedure unless proper safety precautions are taken. 1) Perform all operations in a clean box, which is treated with a nitrogen atmosphere, and in which is completely sealed from the air. 2) After each procedure, all glassware and non-electric equipment should be soaked in a bleach (sodium hypochlorite) solution before removing from the clean box. Any electrical equipment such as hot plates and stirring equipment should be carefully wiped down with a bleached soaked rag before removing from the clean box. 3) After the entire operation is complete, the entire clean box should be disinfected with bleach before opening the clean box to the air. 4) The desired chlorosoman product should be stored in amber bottles, preferably

## Chapter 10: Preparation of Nerve Agents

non-breakable containers, and stored in a cool dry place away from sunlight. The bottles should also be placed inside an airtight sealed plastic bag, such as a 'ziplock' bag. 5) Storage of any and all nerve agents should be in airtight cabinets, drawers, or the like, and said storage spaces should be equipped with chemical agent detection monitors to alert of any potential leakage.

Use caution when handling methyl phosphonic dichloride, which is highly toxic, and can be absorbed through the skin causing mild nerve agent symptoms. Use care when handling phosphorus trichloride, and aluminum chloride, both of which can cause irritation of the skin and eyes, and both of which violently react with water evolving corrosive and toxic fumes. Avoid inhalation of toluene vapors, as they are potentially carcinogenic. Wear gloves when handling concentrated hydrochloric acid, and avoid inhalation of the vapors.

### Procedure:

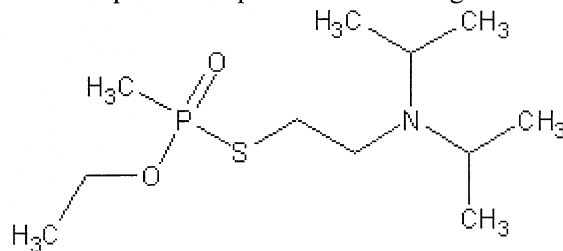
#### Step 1: Preparation of methyl phosphonic dichloride

Place 20 grams of pure phosphorus trichloride, 19.4 grams of pure anhydrous aluminum chloride, and a lecture bottle of anhydrous methyl chloride into a freezer, and chill to 0 Celsius prior to the following. Into a suitable glass stoppered bottle, place 19.4 grams of cold anhydrous aluminum chloride, and then 20 grams of cold phosphorus trichloride. Shortly thereafter, transfer in 22 grams of liquid methyl chloride. Then, stopper the bottle, and then shake the bottle for 1 hour to dissolve all solids. Note: Use caution as heat of reaction may boil-off some of the liquid methyl chloride producing dangerous pressures. If need be, the liquid methyl chloride can be replaced by rapidly bubbling 22 grams of ice cold methyl chloride gas into the phosphorus trichloride/aluminum chloride mixture, followed by stoppering the flask, and then shaking for 1 hour to dissolve all solids. After 1 hour, stop shaking, and then place the stoppered flask into a freezer and chill at 0 Celsius for 24 hours. After 24 hours, filter-off the precipitated solid, and then allow it dry in a desiccator filled with anhydrous sodium sulfate. When the solid is thoroughly dry, dissolve it into 292 milliliters of methylene chloride, and then chill this mixture to 0 Celsius by use of an ice bath. Then, place 36.8 milliliters of cold 35 to 37% hydrochloric acid into an addition funnel, and then add this acid, drop wise (at the rate of 10 drops per minute), to the methylene chloride mixture. Stir the methylene chloride mixture thoroughly during the addition of the hydrochloric acid. After the addition of the hydrochloric acid, continue to stir the reaction mixture for 90 minutes, while keeping the temperature at 5 Celsius or lower during the whole time. After stirring for 2 hours, filter-off any insoluble impurities, and then remove the upper water layer using a separatory funnel. Thereafter, place the methylene chloride layer into a distillation apparatus, or rotary evaporator, and then remove the methylene chloride solvent under vacuum. Note: if vacuum apparatus is unavailable, carefully distilling-off the methylene chloride at 40 Celsius can be used. After the solvent has been removed, place the remaining material into a clean rotary evaporator, or vacuum distillation apparatus, and distill the methyl phosphonic dichloride at 28 millimeters of mercury to obtain a semi-solid colorless mass, or clear liquid of methyl phosphonic dichloride.

#### Step 2: Preparation of chlorosoman

Prepare a solution by adding and dissolving 20 grams of the product obtained in step 1 into 40 grams of toluene. Thereafter, add 10 grams of pyridine, and then stir the mixture for 10 minutes at room temperature. Then place the mixture into a cooling bath, and chill to about 0 Celsius by means of ice. When the temperature of the mixture reaches 0 Celsius, add drop-wise, 15.2 grams of anhydrous pinacolyl alcohol over a sufficient time as to maintain the reaction temperature around 0 Celsius. During the alcohol addition, rapidly stir the reaction mixture. After the alcohol addition, continue to stir reaction mixture for 1 hour at 0 Celsius. Thereafter, remove the cooling bath, and allow the reaction mixture to warm to room temperature, and thereafter stir the reaction mixture for 1 hour. Then gently reflux the reaction mixture at 40 Celsius for 30 minutes. After refluxing for 30 minutes, remove the heat source, and allow the reaction mixture to cool to room temperature. Thereafter, pour the entire reaction mixture into 70 milliliters of ice water, and then stir the mixture for 10 minutes. Immediately thereafter, remove the upper toluene layer using a separatory funnel, or by decantation, and then add 5 grams of anhydrous calcium chloride, and stir the benzene layer for 5 minutes. Immediately thereafter, filter-off the insoluble calcium chloride, and then place the filtered toluene mixture into a rotary evaporator or vacuum distillation apparatus, and remove the benzene under vacuum, and under a temperature of 30 Celsius. After the benzene has been removed, place the remaining residue into a clean vacuum distillation apparatus, and distill the chlorosoman at 89 Celsius under a vacuum of 7 millimeters of mercury to obtain a refined chlorosoman product.

**04-016. VX. TX-60; S-(2-diisopropylaminoethyl)-O-ethyl methylphosphonothiolate; O-ethyl S-[2-(diisopropylamino)ethyl]methylphosphonothioate; Methylphosphonothioic acid S-[2-[bis(1-methylethyl)amino]ethyl] O-ethyl ester;**



VX

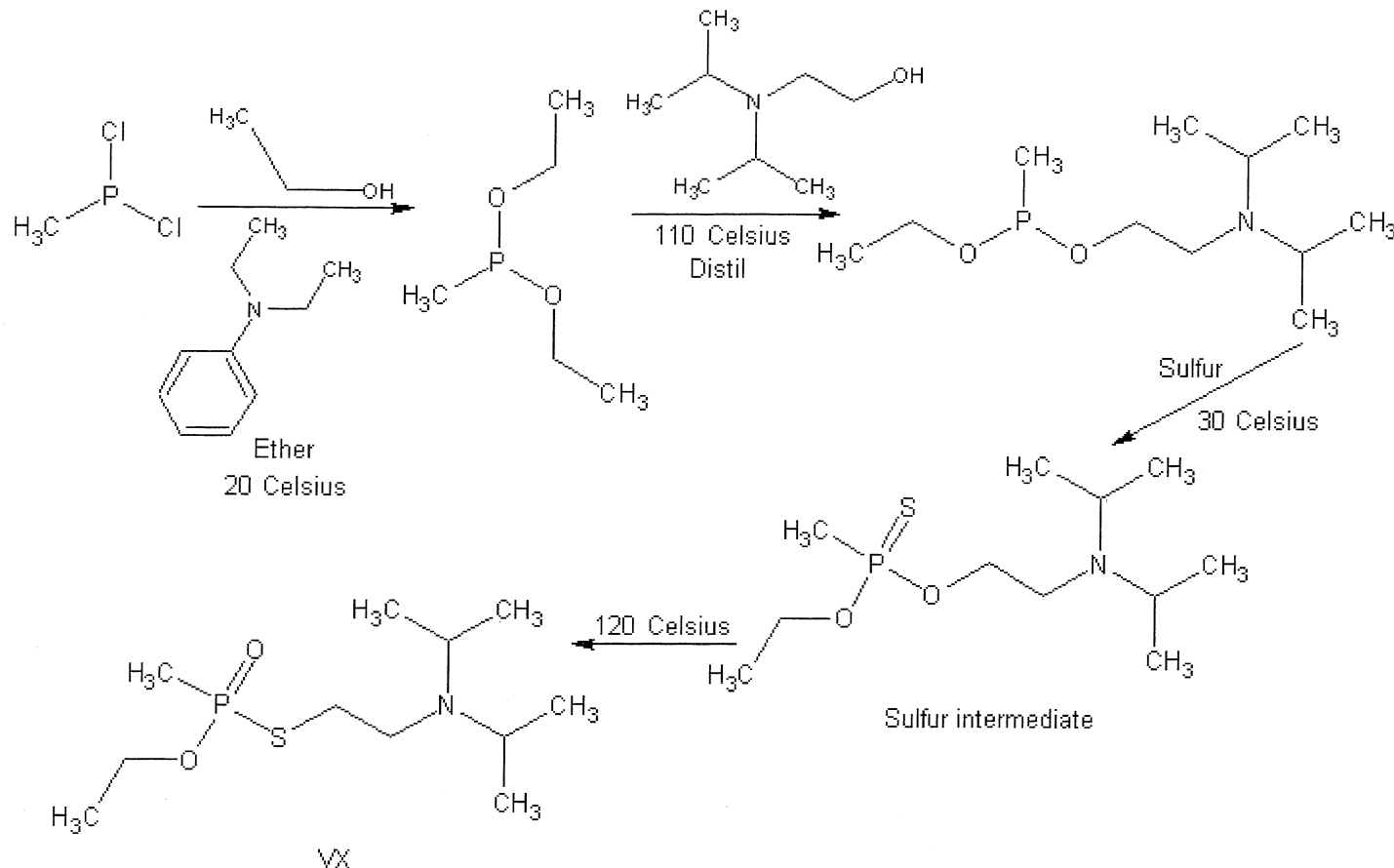
VX forms a colorless odorless liquid, which has a distinct amber color when impure. When impure, it has a slight odor of rotten fish, and a thiosulfur like odor (reminiscent to a dilute odor of leaking natural gas). Pure VX is odorless, and gives absolutely no sign of its presence. VX has a melting point of  $-39$  Celsius, and a boiling point of  $298.4$  Celsius (with decomposition). VX can be distilled at  $157$  Celsius under  $5$  millimeters of mercury with only some decomposition. The solubility of VX in water is  $1$  gram in  $32$  grams of water ( $3\%$  solution by weight). VX is very soluble in many organic solvents, fats, and lipids. The stability of VX in water is absolutely remarkable. It can persist in water solution for up to  $2$  months under normal conditions. Droplets of VX onto water can persist for up to  $3$  months. VX shows no volatility under normal conditions, and evaporates about  $1500$  times slower than sarin. As with other agents, it is decomposed by bleaching powder, and alkalis. Although, solutions of alkalis decompose VX at much slower rates than the other nerve agents. The half-life of VX is  $36$  hours at  $150$  Celsius. VX is by far the greatest chemical warfare agent known to man. It can remain in almost any environment for up to  $2$  to  $3$  months without appreciable decomposition. The stability of VX in dry and cool environments can be even greater; up to  $4$  months. VX is the most effective and largest volume produced nerve agent in any military arsenal, and its manufacture and use has been strictly debated by most nations. The reasons are the fact that VX can persist for months in almost any environment, and these environments can become uninhabitable by humans and animals for very long periods of time, ranging from  $2$  months to  $6$  months. VX was stockpiled in huge quantities by the US, Soviet Union, and China during the cold war, and even to this day, huge stockpiles of VX are probably common by most nations who wish to make it. Some common Russian long-range missiles were equipped to carry up to  $500$  gallons of pure VX, and were capable of contaminating huge areas, including entire cities. Battlefield use of VX is delivered by many common munitions such as mortar shells, artillery bombs, aerial bombs, rockets, grenades, land mines, missiles, and common dissemination systems carried by aircraft, and ground vehicles. Due to VX's environmental stability, its use in tactical warfare operations is more than relevant. In one tactical example, VX can be used to contaminate environments to "divert" enemy troops into a kill zone, hold back enemy troop advancements, preoccupy troop movements, or keep them from advancing in desired directions. Like land mines, VX can be used as such to ambush unsuspecting enemy personnel, and the like. Environments contaminated with VX can cause casualties to unprotected personnel for up to  $3$  months. The most common means of human contamination is through skin contact and absorption, or eye absorption. In many cases, people exposed to VX by skin contact will have no signs of contamination until its too late. VX can be disseminated using aerosols, explosives munitions, atomizers or humidifiers, or foggers. **VX is a rapid acting casualty producing nerve agent capable of producing casualties within minutes of dissemination or exposure by personnel. Toxicity: Lethal dose 50% of population s.c. in rabbits: 0.0154 milligrams per kilogram of body weight. The Most toxic nerve agent known to man. The lethal dose for the average man is about 0.009 milligrams per kilogram (734 micrograms lethal dose for man of 180 pounds of weight). When used properly, 5 milligrams of VX can kill 6.8 soldiers. Personnel exposed to non-lethal amounts of the agent may still become incapacitated within minutes of exposure, and will become unable to perform their normal duties as soldiers. Those personnel exposed to lethal doses will be dead within 15 minutes to 1 hour. VX is highly toxic through ingestion, inhalation, and skin and eye absorption.**

OVERALL RATING (scale from 1 to 10)	
<i>Effectiveness (as nerve agent):</i> 10	<i>Field Stability:</i> 10
<i>Persistence (open area):</i> 10	<i>Storage stability:</i> 10
<i>Persistence (enclosed area):</i> 10	<i>Toxicity (as nerve agent):</i> 10
<b>TOTAL EFFECTIVENESS (as nerve agent):</b> 10	
<b>OVERALL TOXICITY (as warfare agent):</b> 9¾	

### Procedure 04-016A: Preparation of VX

**Summary:** VX is made in a three-step process starting with the formation of ethyl methylphosphonite. The phosphonite is prepared by the reaction of dichloromethylphosphine with ethyl alcohol in the presence of diethylaniline. The diethylaniline removes the hydrogen chloride formed during the reaction. The resulting ethyl methylphosphonite is then recovered by filtering the reaction mixture to remove insoluble impurities, distilled to recover the ether, and then fractionally distilled under vacuum to obtain the ethyl methylphosphonite. This product is then converted into ethyl 2-diisopropylaminoethyl methylphosphonite by reaction with 2-diisopropylaminoethanol. The reaction mixture is then heated to distill-off the by-product ethanol, and the resulting reaction mixture

then cooled to room temperature, and then vacuum distilled twice, to recover the desired ethyl 2-diisopropylaminoethyl methylphosphonite. This ethyl 2-diisopropylaminoethyl methylphosphonite is then converted into VX by the reaction with ordinary powdered rhombic sulfur, followed by heating to 120 Celsius to inflict a chemical rearrangement of the sulfur intermediate. The VX is then collected by either vacuum distillation, or by solvent treatment. Note: This entire process is similar or related to the process discussed in application number 62,305 Oct. 12<sup>th</sup>, 1960 by Sigmund R. Eckhaus, Baltimore MD; Jefferson C. Davis, Jr., Austin, TX; Bernard M. Zeffert, Baltimore, MD; and Thomas R. Moore, Hoboken, NJ; assigned by the United States Army. This process may be protected by industrial/commercial process applications. Consult said application number before using the mentioned process for commercial or industrial purposes.



*Reaction Equation (by-products omitted)*

<b>Materials:</b>	1. 950 milliliters of anhydrous diethyl ether	4. 313.5 grams of N,N-diethylaniline
	2. 117 grams of purified dichloromethylphosphine	5. 20.1 grams of 2-diisopropylaminoethanol
	3. 96.6 grams of anhydrous ethyl alcohol	6. 2.9 grams powdered rhombic sulfur

**Hazards:**



**WARNING! WARNING! WARNING! WARNING! WARNING!**

Do not attempt in anyway to prepare VX using the following procedure unless proper safety precautions are taken. 1) Perform all operations in a clean box, which is treated with a nitrogen atmosphere, and in which is completely sealed from the air. 2) After each procedure, all glassware and non-electric equipment should be soaked in a bleach (sodium hypochlorite) solution before removing from the clean box. Any electrical equipment such as hot plates and stirring equipment should be carefully wiped down with a bleached soaked rag before removing from the clean box. 3) After

## Chapter 10: Preparation of Nerve Agents

the entire operation is complete, the entire clean box should be disinfected with bleach before opening the clean box to the air. 4) The desired VX product should be stored in amber bottles, preferably non-breakable containers, and stored in a cool dry place away from sunlight. The bottles should also be placed inside an airtight sealed plastic bag, such as a 'ziplock' bag. 5) Storage of any and all nerve agents should be in airtight cabinets, drawers, or the like, and said storage spaces should be equipped with chemical agent detection monitors to alert of any potential leakage. Use care when handling dichloromethylphosphine, which can be absorbed through the skin. Diethyl ether is highly flammable, so extinguish all flames before use, and perform the peroxide test before heating. Ethanol is flammable, so use necessary precautions.

### Procedure:

#### Step 1: Preparation of Diethyl methylphosphonite

Note: All flasks, and apparatus should be flushed with nitrogen before each process (to remove oxygen), and all apparatus should be equipped with nitrogen purge and mercury bubblers to keep air out (with the exception of the filtration process using the Buchner funnel). Into a flask place 500 milliliters of anhydrous diethyl ether, followed by 117 grams of purified dichloromethylphosphine. Immediately thereafter, prepare a mixture by adding 96.6 grams of anhydrous ethyl alcohol to 313.5 grams of N,N-diethyl aniline. Then stir this ethyl alcohol solution to form a uniform mixture. Thereafter, place this solution into a dropping funnel, and attach the dropping funnel to the flask containing the ethyl ether (see figure 048). Then place the flask containing the ethyl ether and dichloromethylphosphine into an ice bath, and quickly chill to 20 Celsius. Then add drop wise, the ethyl alcohol/N,N-diethylaniline mixture to the ethyl ether and dichloromethylphosphine mixture while stirring the ethyl ether/dichloromethylphosphine mixture and maintaining its temperature at 20 to 30 Celsius. After the addition, continue to stir the reaction mixture for 90 minutes at 20 Celsius. After 90 minutes, remove the flask from the apparatus illustrated in figure 048, and then pour the entire contents of said flask into a Buchner funnel (connected to a mild vacuum, i.e. just like vacuum filtration), and filter-off any insoluble materials. Thereafter, quickly flush the empty reaction flask with 150 milliliters of anhydrous diethyl ether (to remove any residue clinging to the inner walls of the flask), and then pour said ether into the Buchner funnel. Then continue to vacuum filter the filtered-off insoluble materials, and then wash these filtered-off insoluble materials with two 150 milliliter portions of anhydrous diethyl ether. Then place the filtered reaction mixture into a distillation apparatus (see figure 049), and then remove the ether at 60 Celsius. Note: during the distillation, use a nitrogen purge. After all the ether has been removed, remove the remaining residue from the flask, and then place into a clean rotary evaporator, or vacuum distillation apparatus, and fractionally distill the product at 47 Celsius under a vacuum of 50 millimeters of mercury to obtain 111 grams of the desired product. Note: During the vacuum distillation process, no nitrogen purge should be used.

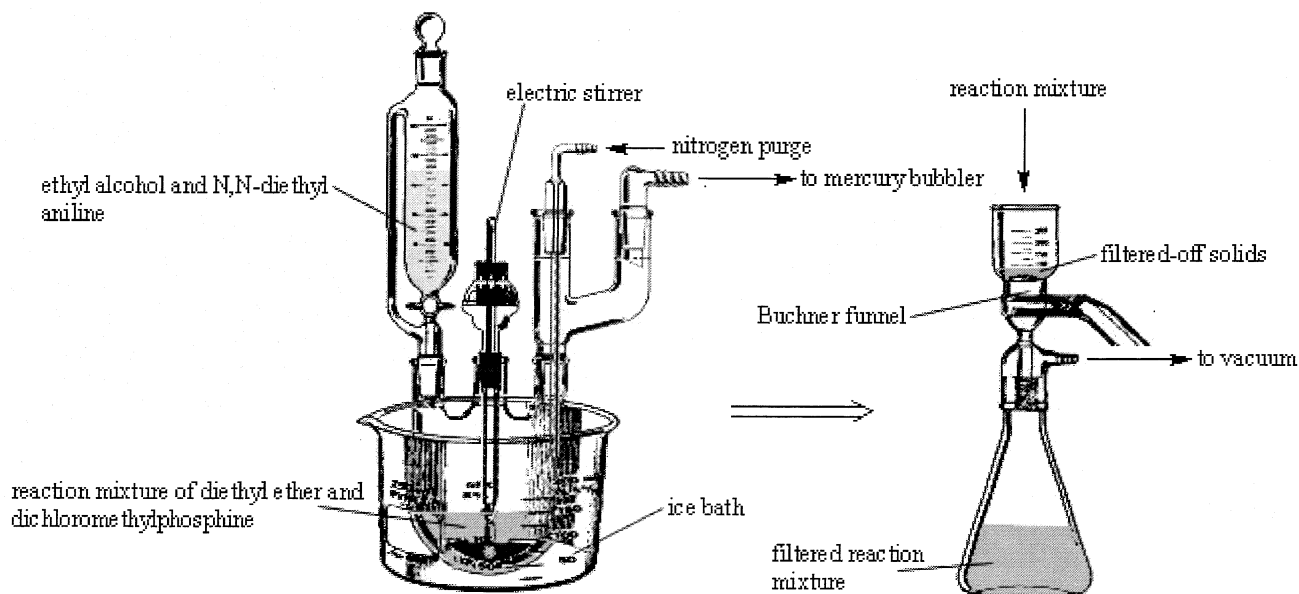
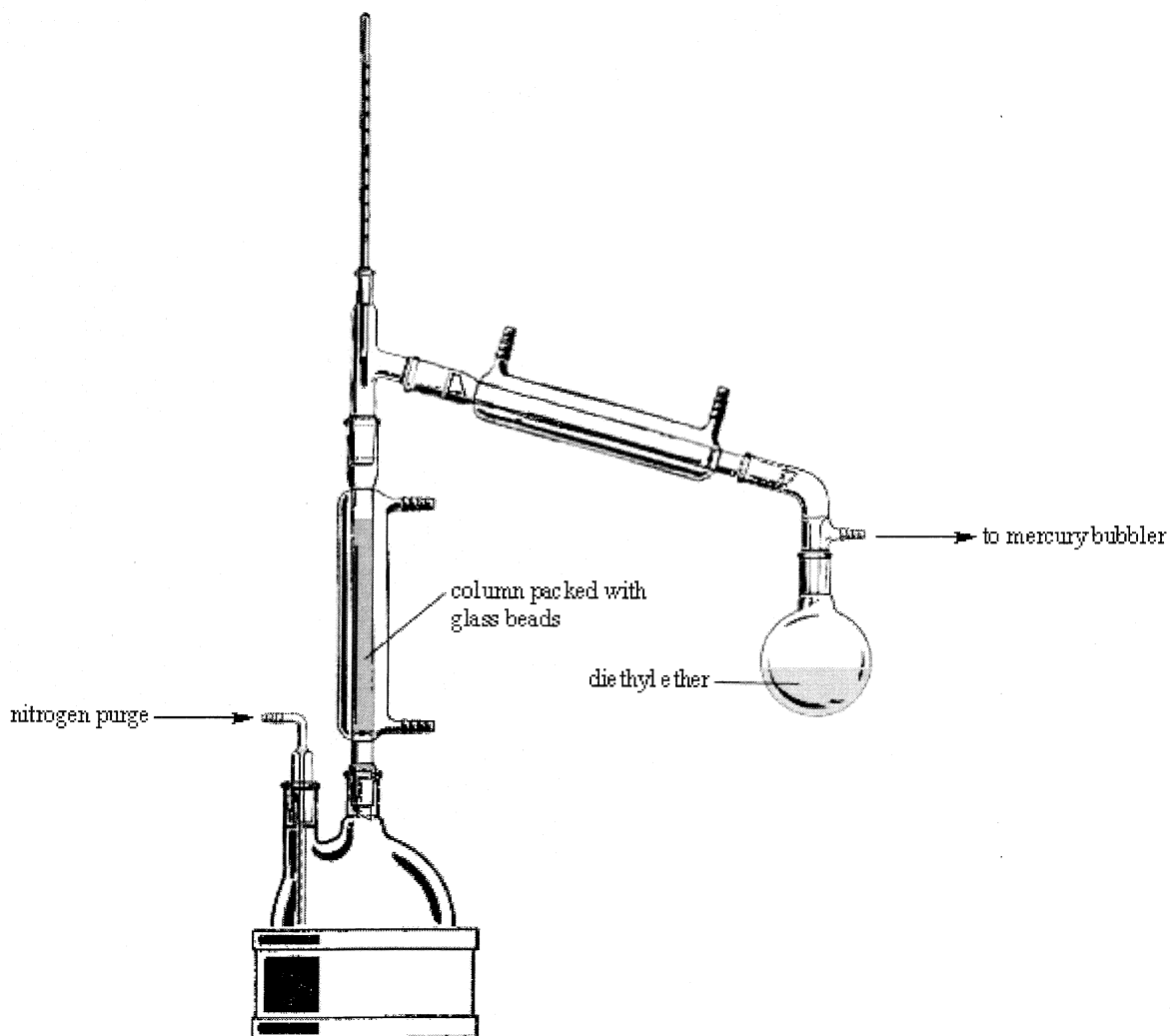


Figure 048. Setup for step 1. Left illustration: Addition of the ethyl alcohol and N,N-diethylaniline. Right illustration: setup to remove insoluble materials.



**Figure 049.** Setup for the removal of diethyl ether in step 1. Use a nitrogen purge when distilling-off the ether.

**Step 2: Preparation of ethyl 2-diisopropylaminoethyl methylphosphonite**

Note: All flasks and apparatus should be flushed with nitrogen before each process (to remove oxygen), and all apparatus should be equipped with nitrogen purge and mercury bubblers to keep the air out. Into a suitable flask, place 37.5 grams of the product obtained in step 1, and then rapidly add 20.1 grams of 2-diisopropylaminoethanol. Thereafter, gradually heat the reaction mixture to 110 Celsius over a period of 28 minutes in a distillation apparatus (equipped with nitrogen purge and mercury bubbler). During the heating process, ethanol will be continuously distilled over. After the initial 28-minute heating period, continue to heat the reaction mixture at 110 Celsius for 33 minutes. Note: 6.3 grams of ethanol should be distilled over, so if at the end of the 33-minute heating period, less than 6.3 grams of ethanol is in the receiver flask, continue heating at 110 to 150 Celsius for additional time to recover all 6.3 grams of ethanol. After the heating period, and after all the ethanol has been recovered in the receiver flask, remove the heat source, and allow the reaction mixture to cool to room temperature. Note: During the cool down period, continue the nitrogen purge. Thereafter, remove the flask containing the reaction mixture, and place into a clean vacuum distillation apparatus, and then distill the reaction mixture at 48 Celsius under a vacuum of 50 millimeters of mercury to obtain the byproduct, diethyl methylphosphonite. Note: during the vacuum distillation process, do not use a nitrogen purge. The yield of this by-product will be about 16 grams. After this by-product has been removed, place the flask containing the remaining residue into a clean vacuum distillation apparatus, and fractionally distill the ethyl 2-diisopropylaminoethyl methylphosphonite at 54 Celsius under a vacuum of 0.10 millimeters of mercury to obtain about 22 grams of the desired ethyl 2-diisopropylaminoethyl methylphosphonite. Note: during the vacuum distillation process, do not use a nitrogen purge.

**Step 3: Preparation of VX**

Assemble the apparatus in figure 050, and then place 21 grams of the product obtained in step 2, into the reaction flask. Thereafter, begin a nitrogen purge to maintain an inert atmosphere within the reaction apparatus all throughout the process. Then place the reaction flask into an oil bath filled with ethylene glycol, and gently heat the contents in the reaction flask to 30 Celsius. Then, by use of a powder addition funnel, slowly add 2.9 grams of finely powdered rhombic sulfur over a period of about 5 minutes while stirring the ethyl 2-diisopropylaminoethyl methylphosphonite product contained in the reaction flask. During the addition, maintain the reaction temperature at 30 Celsius. Note: during the addition of the sulfur, the temperature of the ethylene glycol oil bath may increase above 30 Celsius. To avoid any increase of temperature above 30 Celsius, small pieces of dry ice should be added to the ethylene glycol oil bath; an electric thermometer equipped with an LCD display should be used to monitor the temperature of the ethylene glycol oil bath. After the addition of the sulfur, continue to stir the reaction mixture, and maintain its temperature at 30 Celsius for about an additional 5 minutes. After which, immediately raise the temperature of the ethylene glycol oil bath to 120 Celsius as quickly as possible, but not too quick as to over heat above the recommended 120 Celsius mark. Then heat the reaction mixture while stirring for about 10 minutes at 120 Celsius. After heating for 10 minutes, remove the heat source, and allow the reaction mixture to cool to room temperature. Then place the reaction mixture into a clean vacuum distillation apparatus, and vacuum distill the VX under high vacuum and under a temperature of 150 Celsius to obtain a relatively pure VX product. Note: do not use a nitrogen purge when vacuum distilling the VX. Note: Instead of vacuum distilling the VX, the reaction flask can be removed from the reaction apparatus of figure 050, and then any where from 50 to 500 milliliters of methylene chloride, ether, or any other desired solvent can be added to dissolve the VX product. This resulting mixture containing the desired solvent and the VX can then be evaporated under vacuum, or carefully distilled, to remove the solvent, and leave behind a refined VX product (well suitable for use in warfare operations), or can be used as such in chemical warfare operations when properly disseminated.

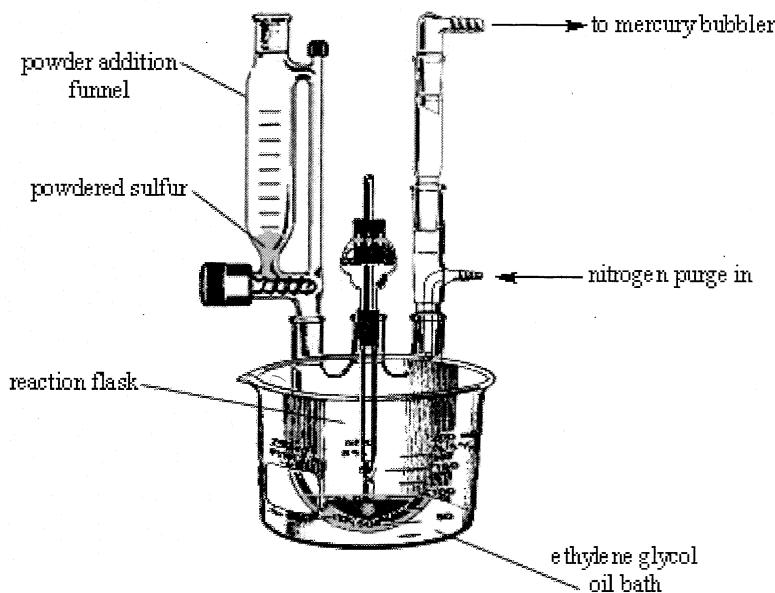
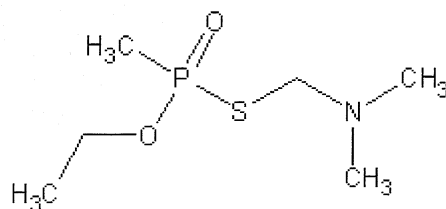


Figure 050. Apparatus for the addition of sulfur. The immersion heater is not shown.

**04-017. IIVX. Sub-VX; S-(2-dimethylaminomethyl)-O-ethyl methylphosphonothiolate; O-ethyl S-[2-(dimethylamino)methyl]methylphosphonothioate;**



IIVX

IIVX has similar properties to VX, and can be used as a substitute to VX. It is a colorless liquid with a faint odor of fish, and may be the usual amber color when impure. It has a boiling point of 200 to 250 Celsius, and can be distilled at 87 Celsius under a vacuum of 5 millimeters of mercury. The toxicity and environmental persistence of IIVX would be lower than VX, due to its decreased molecular

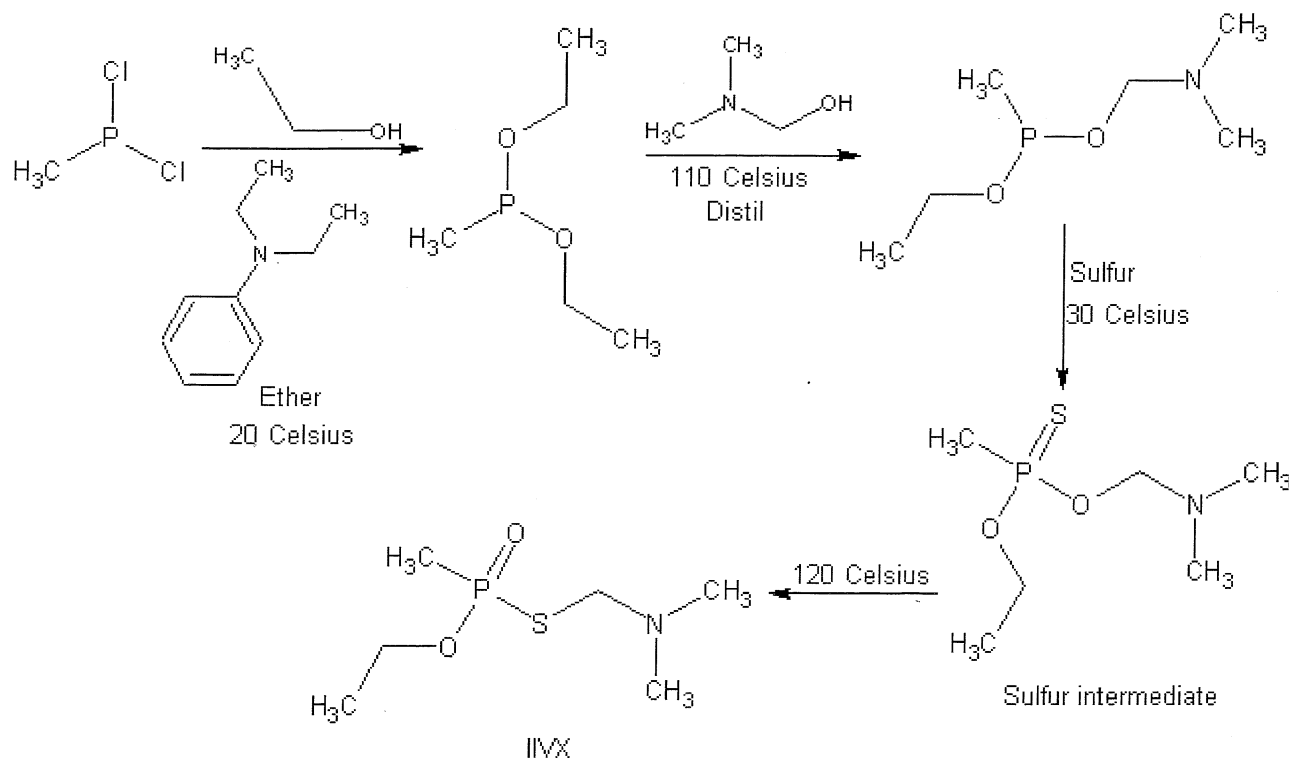
Chapter 10: Preparation of Nerve Agents

weight, but it would demonstrate excellent battle field use in place of VX. IIVX would have a melting point of about -60 to -40 Celsius. It is moderately soluble in water (248 grams per liter at pH 7), and is very soluble in the usual organic solvents. It can be effectively disseminated using aerosols, explosives munitions, atomizers or humidifiers, or foggers. **IIVX is a fast acting casualty producing nerve agent capable of causing casualties within minutes of dissemination. Toxicity: Lethal dose 50% of population: unknown, possibly as low as 0.05 milligrams per kilogram of body weight. The lethal dose for the average man may be about 0.014 to 0.057 milligrams per kilogram (1.14 to 4.6 milligrams lethal dose for man of 180 pounds of weight). Personnel exposed to non-lethal amounts of the agent may still become incapacitated within days of exposure, and will become unable to perform their normal duties as soldiers. IIVX is highly toxic through ingestion, inhalation, and skin and eye absorption.**

OVERALL RATING (scale from 1 to 10)	
<i>Effectiveness (as nerve agent): 8</i>	<i>Field Stability: 10</i>
<i>Persistence (open area): 10</i>	<i>Storage stability: 10</i>
<i>Persistence (enclosed area): 10</i>	<i>Toxicity (as nerve agent): 8</i>
<b>TOTAL EFFECTIVENESS (as nerve agent): 9.3</b>	
<b>OVERALL TOXICITY (as warfare agent): 8</b>	

**Procedure 04-017A: Preparation of IIVX**

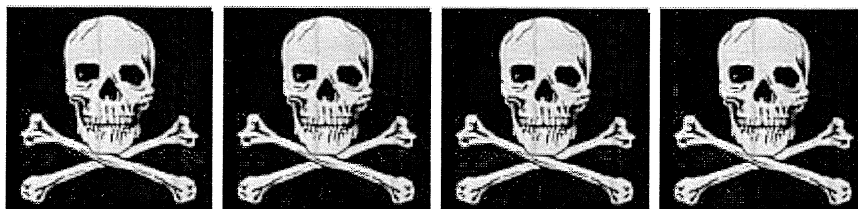
**Summary:** This process is identical to the preparation of VX. IIVX is made in a three-step process starting with the formation of ethyl methylphosphonite. The phosphonite is prepared by the reaction of dichloromethylphosphine with ethyl alcohol in the presence of diethylaniline. The diethylaniline removes the hydrogen chloride formed during the reaction. The resulting ethyl methylphosphonite is then recovered by first, filtering the reaction mixture to remove insoluble impurities, distilled to recover the ether, and then fractionally distilled under vacuum to obtain the ethyl methylphosphonite. This product is then converted into ethyl 2-dimethylaminomethyl methylphosphonite by reaction with 2-dimethylaminomethanol. The reaction mixture is then heated to distill-off the by-product ethanol, and the resulting reaction mixture then cooled to room temperature, and then vacuum distilled twice, to recover the desired ethyl 2-dimethylaminomethyl methylphosphonite. This ethyl 2-dimethylaminomethyl methylphosphonite is then converted into IIVX by the reaction with ordinary powdered rhombic sulfur, followed by heating to 120 Celsius to inflict a chemical rearrangement of the sulfur intermediate. The IIVX is then collected by either vacuum distillation, or by solvent treatment. Note: This entire process is similar or related to the process discussed in application number 62,305 Oct. 12<sup>th</sup>, 1960 by Sigmund R. Eckhaus, Baltimore MD; Jefferson C. Davis, Jr., Austin, TX; Bernard M. Zeffert, Baltimore, MD; and Thomas R. Moore, Hoboken, NJ; assigned by the United States Army. This process may be protected by industrial/commercial process applications. Consult said application number before using the mentioned process for commercial or industrial purposes.



*Reaction Equation (by-products omitted)*



<b>Materials:</b>	1. 950 milliliters of anhydrous diethyl ether	4. 313.5 grams of N,N-diethylaniline
	2. 117 grams of purified dichloromethylphosphine	5. 10.5 grams of 2-dimethylaminomethanol
	3. 96.6 grams of anhydrous ethyl alcohol	6. 4.07 grams powdered rhombic sulfur

**Hazards:**

**WARNING! WARNING! WARNING! WARNING!**

Do not attempt in anyway to prepare IIVX using the following procedure unless proper safety precautions are taken.

1) Perform all operations in a clean box, which is treated with a nitrogen atmosphere, and in which is completely sealed from the air. 2) After each procedure, all glassware and non-electric equipment should be soaked in a bleach (sodium hypochlorite) solution before removing from the clean box. Any electrical equipment such as hot plates and stirring equipment should be carefully wiped down with a bleached soaked rag before removing from the clean box. 3) After the entire operation is complete, the entire clean box should be disinfected with bleach before opening the clean box to the air. 4) The desired IIVX product should be stored in amber bottles, preferably non-breakable containers, and stored in a cool dry place away from sunlight. The bottles should also be placed inside an airtight sealed plastic bag, such as a 'ziplock' bag. 5) Storage of any and all nerve agents should be in airtight cabinets, drawers, or the like, and said storage spaces should be equipped with chemical agent detection monitors to alert of any potential leakage. Use care when handling dichloromethylphosphine, which can be absorbed through the skin. Diethyl ether is highly flammable, so extinguish all flames before use, and perform the peroxide test before heating. Ethanol is flammable, so use necessary precautions.

**Procedure:****Step 1: Preparation of Diethyl methylphosphonite**

Note: All flasks, and apparatus should be flushed with nitrogen before each process (to remove oxygen), and all apparatus should be equipped with nitrogen purge and mercury bubblers to keep air out (with the exception of the filtration process using the Buchner funnel). Into a flask place 500 milliliters of anhydrous diethyl ether, followed by 117 grams of purified dichloromethylphosphine. Immediately thereafter, prepare a mixture by adding 96.6 grams of anhydrous ethyl alcohol to 313.5 grams of N,N-diethyl aniline. Then stir this ethyl alcohol solution to form a uniform mixture. Thereafter, place this solution into a dropping funnel, and attach the dropping funnel to the flask containing the ethyl ether (see figure 048; 4-0016A). Then place the flask containing the ethyl ether and dichloromethylphosphine into an ice bath, and quickly chill to 20 Celsius. Then add drop wise, the ethyl alcohol/N,N-diethylaniline mixture to the ethyl ether and dichloromethylphosphine mixture while stirring the ethyl ether/dichloromethylphosphine mixture and maintaining its temperature at 20 to 30 Celsius. After the addition, continue to stir the reaction mixture for 90 minutes at 20 Celsius. After 90 minutes, remove the flask from the apparatus illustrated in figure 048, and then pour the entire contents of said flask into a Buchner funnel (connected to a mild vacuum, i.e. just like vacuum filtration), and filter-off any insoluble materials. Thereafter, quickly flush the empty reaction flask with 150 milliliters of anhydrous diethyl ether (to remove any residue clinging to the inner walls of the flask), and then pour said ether into the Buchner funnel. Then continue to vacuum filter the filtered-off insoluble materials, and then wash these filtered-off insoluble materials with two 150 milliliter portions of anhydrous diethyl ether. Then place the filtered reaction mixture into a distillation apparatus (see figure 049; 4-0016A), and then remove the ether at 60 Celsius. Note: during the distillation, use a nitrogen purge. After all the ether has been removed, remove the remaining residue from the flask, and then place into a clean rotary evaporator, or vacuum distillation apparatus, and fractionally distill the product at 47 Celsius under a vacuum of 50 millimeters of mercury to obtain 111 grams of the desired product. Note: During the vacuum distillation process, no nitrogen purge should be used.

**Step 2: Preparation of ethyl 2-dimethylaminomethyl methylphosphonite**

Note: All flasks and apparatus should be flushed with nitrogen before each process (to remove oxygen), and all apparatus should be equipped with nitrogen purge and mercury bubblers to keep the air out. Into a suitable flask, place 37.5 grams of the product obtained in step 1, and then rapidly add 10.5 grams of 2-dimethylaminomethanol. Thereafter, gradually heat the reaction mixture to 110 Celsius over a period of 28 minutes in a distillation apparatus (equipped with nitrogen purge and mercury bubbler). During the heating process, ethanol will be continuously distilled over. After the initial 28-minute heating period, continue to heat the reaction mixture at

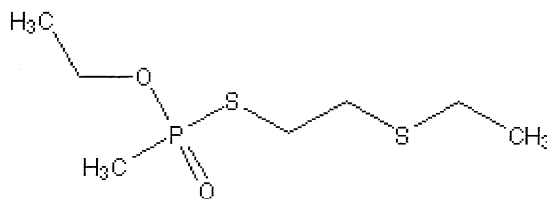
## Chapter 10: Preparation of Nerve Agents

110 Celsius for 33 minutes. Note: 6.3 grams of ethanol should be distilled over, so if at the end of the 33-minute heating period, less than 6.3 grams of ethanol is in the receiver flask, continue heating at 110 to 150 Celsius for additional time to recover all 6.3 grams of ethanol. After the heating period, and after all the ethanol has been recovered in the receiver flask, remove the heat source, and allow the reaction mixture to cool to room temperature. Note: During the cool down period, continue the nitrogen purge. Thereafter, remove the flask containing the reaction mixture, and place into a clean vacuum distillation apparatus, and then distill the reaction mixture at 48 Celsius under a vacuum of 50 millimeters of mercury to obtain the byproduct, diethyl methylphosphonite. Note: during the vacuum distillation process, do not use a nitrogen purge. After this by-product has been removed, place the flask containing the remaining residue into a clean vacuum distillation apparatus, and fractionally distill the ethyl 2-dimethylaminomethyl methylphosphonite at 20 to 50 Celsius under a vacuum of 1 to 0.10 millimeters of mercury to obtain the desired ethyl 2-dimethylaminomethyl methylphosphonite. Note: during the vacuum distillation process, do not use a nitrogen purge.

### Step 3: Preparation of IIVX

Assemble the apparatus in figure 050 (4-0016A), and then place 21 grams of the product obtained in step 2, into the reaction flask. Thereafter, begin a nitrogen purge to maintain an inert atmosphere within the reaction apparatus all throughout the process. Then place the reaction flask into an oil bath filled with ethylene glycol, and gently heat the contents in the reaction flask to 30 Celsius. Then, by use of a powder addition funnel, slowly add 4.07 grams of finely powdered rhombic sulfur over a period of about 5 minutes while stirring the ethyl 2-dimethylaminomethyl methylphosphonite product contained in the reaction flask. During the addition, maintain the reaction temperature at 30 Celsius. Note: during the addition of the sulfur, the temperature of the ethylene glycol oil bath may increase above 30 Celsius. To avoid any increase of temperature above 30 Celsius, small pieces of dry ice should be added to the ethylene glycol oil bath; an electric thermometer equipped with an LCD display should be used to monitor the temperature of the ethylene glycol oil bath. After the addition of the sulfur, continue to stir the reaction mixture, and maintain its temperature at 30 Celsius for about an additional 5 minutes. After which, immediately raise the temperature of the ethylene glycol oil bath to 120 Celsius as quickly as possible, but not too quick as to over heat above the recommended 120 Celsius mark. Then heat the reaction mixture while stirring for about 10 minutes at 120 Celsius. After heating for 10 minutes, remove the heat source, and allow the reaction mixture to cool to room temperature. Then place the reaction mixture into a clean vacuum distillation apparatus, and vacuum distill the IIVX at 87 Celsius under a vacuum of 5 millimeters of mercury to obtain a relatively pure IIVX product. Note: do not use a nitrogen purge when vacuum distilling the IIVX. Note: **Instead of vacuum distilling the IIVX, the reaction flask can be removed from the reaction apparatus of figure 050 (4-0016A), and then any where from 50 to 500 milliliters of methylene chloride, ether, or any other desired solvent can be added to dissolve the IIVX product. This resulting mixture containing the desired solvent and the IIVX can then be evaporated under vacuum, or carefully distilled, to remove the solvent, and leave behind a refined IIVX product (well suitable for use in warfare), or can be used as such in chemical warfare operations when properly disseminated.**

### 04-018. V-sub x. O-Ethyl 2-ethylthioethyl methylphosphonothioate



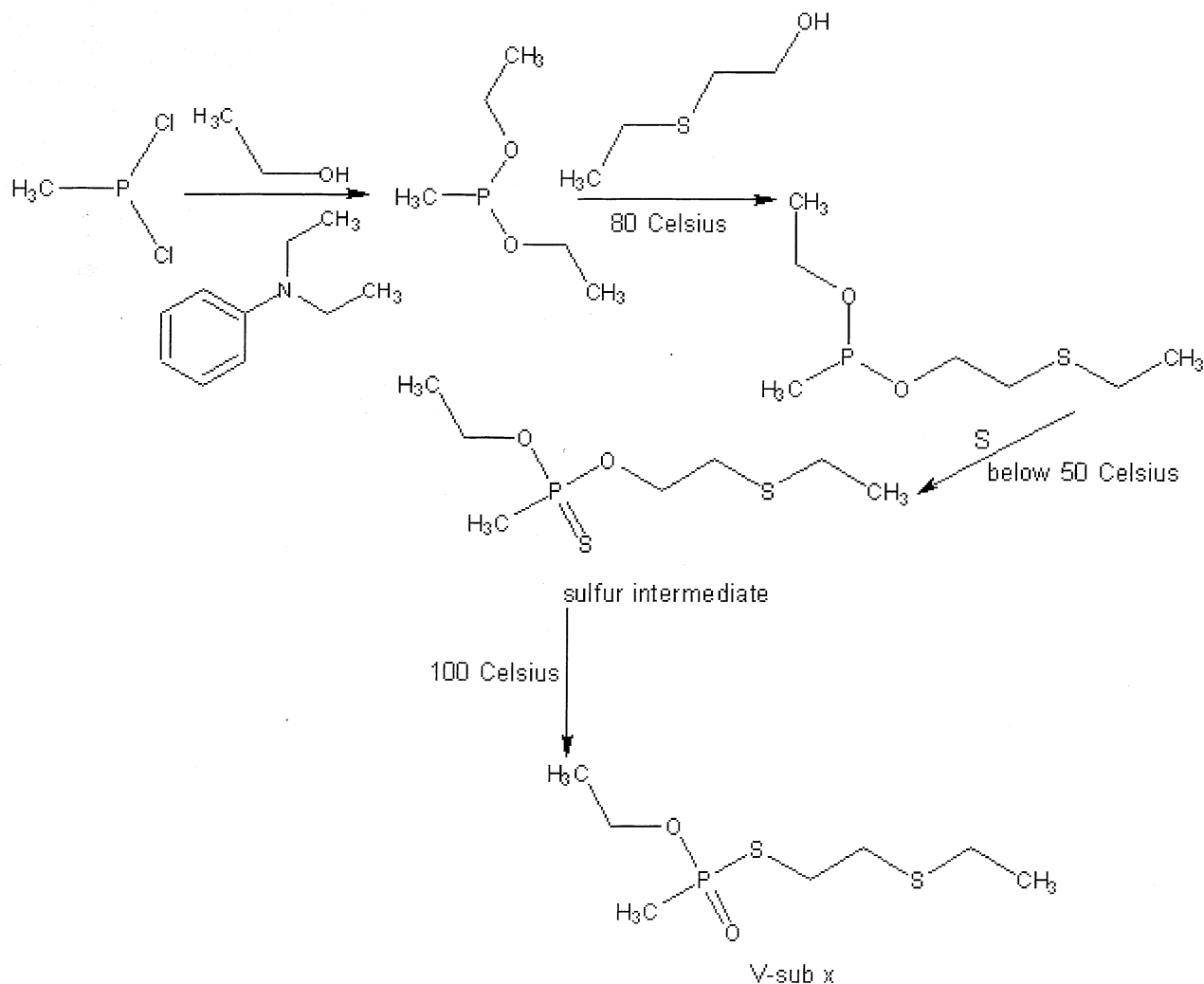
V-sub x

Very little is known about V-sub x, but it is presumed to be an odorless, colorless to slightly colored liquid. It has a boiling point of 280 to 320 Celsius, with decomposition starting around 150 Celsius. It can be distilled at 139 Celsius under a vacuum of 5 millimeters of mercury. The impure liquid may be light amber to brownish, or light tan in color. It is not very soluble in water, but is readily soluble in most common organic solvents. V-sub x is an effective biologically active agent, capable of being used in admixture with VX, or with other nerve agents. V-sub x demonstrates excellent stability, and persistence. Its persistence in the environment may be up to 2 months under normal conditions, but it may be less persistent than VX due to its second sulfur atom; gives rise to hydrolysis at a higher rate than VX. V-sub x can be disseminated from aerosols, explosives munitions, atomizers or humidifiers, or foggers. **V-sub x is a fast acting nerve agent capable of causing casualties within 12 hours of dissemination. Personnel exposed to non-lethal amounts of the agent may still become incapacitated within days of exposure, and will become unable to perform their normal duties as soldiers. V-sub x is highly toxic through ingestion, inhalation, and skin and eye absorption. The toxicity through inhalation is unknown, but ranges from 1 to 6 milligrams. Eye absorption of as little as 5 milligrams may be fatal, and skin absorption of 8 to 12 milligrams may be fatal. The agent produces no irritation of any kind upon eye or skin contact, or inhalation.**

<b>OVERALL RATING (scale from 1 to 10)</b>	
<i>Effectiveness (as nerve agent):</i> 8	<i>Field Stability:</i> 10
<i>Persistence (open area):</i> 10	<i>Storage stability:</i> 10
<i>Persistence (enclosed area):</i> 10	<i>Toxicity (as nerve agent):</i> 8
<b>TOTAL EFFECTIVENESS (as nerve agent):</b> 9.3	
<b>OVERALL TOXICITY (as warfare agent):</b> 8	

### Procedure 04-018A: Preparation of V-sub x

**Summary:** V-sub x is prepared in a convenient three step process starting with the formation diethyl methylphosphonite. This diethyl methylphosphonite is prepared in the usual manner as for VX, and after it has been obtained, it is reacted with 2-ethylthioethanol to yield ethyl 2-ethylthioethyl methylphosphonite. This ethyl 2-ethylthioethyl methylphosphonite is then converted into a sulfur intermediate by reaction with ordinary sulfur. The sulfur intermediate is then trans esterified by heating the sulfur intermediate to 100 Celsius. The trans esterification produces the desired V-sub x, which can then be collected by high vacuum distillation, or by solvent extraction with methylene chloride. Note: This entire process is similar or related to the process discussed in application number 62,305 Oct. 12<sup>th</sup>, 1960 by Sigmund R. Eckhaus, Baltimore MD; Jefferson C. Davis, Jr., Austin, TX; Bernard M. Zeffert, Baltimore, MD; and Thomas R. Moore, Hoboken, NJ; as well as serial number 696,296, November 13<sup>th</sup>, 1957, by Friedrich W. Hoffmann, of Bel Air MD, and Thomas R. Moore, of Middletown, NY, both assigned by the United States Army. This process may be protected by industrial/commercial process applications. Consult said application number before using the mentioned process for commercial or industrial purposes.

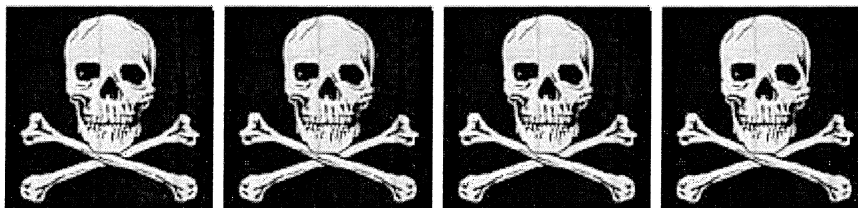


#### Reaction Equation (by-products omitted)

<b>Materials:</b>	1. 950 milliliters of anhydrous diethyl ether	4. 313.5 grams of N,N-diethylaniline
	2. 117 grams of purified dichloromethylphosphine	5. 24 grams of 2-ethylthioethanol

3. 96.6 grams of anhydrous ethyl alcohol

6. 8.3 grams powdered rhombic sulfur

**Hazards:****WARNING! WARNING! WARNING! WARNING!**

Do not attempt in anyway to prepare V-sub x using the following procedure unless proper safety precautions are taken. 1) Perform all operations in a clean box, which is treated with a nitrogen atmosphere, and in which is completely sealed from the air. 2) After each procedure, all glassware and non-electric equipment should be soaked in a bleach (sodium hypochlorite) solution before removing from the clean box. Any electrical equipment such as hot plates and stirring equipment should be carefully wiped down with a bleached soaked rag before removing from the clean box. 3) After the entire operation is complete, the entire clean box should be disinfected with bleach before opening the clean box to the air. 4) The desired V-sub x product should be stored in amber bottles, preferably non-breakable containers, and stored in a cool dry place away from sunlight. The bottles should also be placed inside an airtight sealed plastic bag, such as a 'ziplock' bag. 5) Storage of any and all nerve agents should be in airtight cabinets, drawers, or the like, and said storage spaces should be equipped with chemical agent detection monitors to alert of any potential leakage.

Use care when handling dichloromethylphosphine, which can be absorbed through the skin. Diethyl ether is highly flammable, so extinguish all flames before use, and perform the peroxide test before heating. Ethanol is flammable, so use necessary precautions.

**Procedure:****Step 1: Preparation of Diethyl methylphosphonite**

Note: All flasks, and apparatus should be flushed with nitrogen before each process (to remove oxygen), and all apparatus should be equipped with nitrogen purge and mercury bubblers to keep air out (with the exception of the filtration process using the Buchner funnel). Into a flask place 500 milliliters of anhydrous diethyl ether, followed by 117 grams of purified dichloromethylphosphine. Immediately thereafter, prepare a mixture by adding 96.6 grams of anhydrous ethyl alcohol to 313.5 grams of N,N-diethyl aniline. Then stir this ethyl alcohol solution to form a uniform mixture. Thereafter, place this solution into a dropping funnel, and attach the dropping funnel to the flask containing the ethyl ether (see figure 048; 4-0016A). Then place the flask containing the ethyl ether and dichloromethylphosphine into an ice bath, and quickly chill to 20 Celsius. Then add drop wise, the ethyl alcohol/N,N-diethylaniline mixture to the ethyl ether and dichloromethylphosphine mixture while stirring the ethyl ether/dichloromethylphosphine mixture and maintaining its temperature at 20 to 30 celsius. After the addition, continue to stir the reaction mixture for 90 minutes at 20 Celsius. After 90 minutes, remove the flask from the apparatus illustrated in figure 048, and then pour the entire contents of said flask into a Buchner funnel (connected to a mild vacuum, i.e. just like vacuum filtration), and filter-off any insoluble materials. Thereafter, quickly flush the empty reaction flask with 150 milliliters of anhydrous diethyl ether (to remove any residue clinging to the inner walls of the flask), and then pour said ether into the Buchner funnel. Then continue to vacuum filter the filtered-off insoluble materials, and then wash these filtered-off insoluble materials with two 150 milliliter portions of anhydrous diethyl ether. Then place the filtered reaction mixture into a distillation apparatus (see figure 049; 4-0016A), and then remove the ether at 60 Celsius. Note: during the distillation, use a nitrogen purge. After all the ether has been removed, remove the remaining residue from the flask, and then place into a clean rotary evaporator, or vacuum distillation apparatus, and fractionally distill the product at 47 Celsius under a vacuum of 50 millimeters of mercury to obtain 111 grams of the desired product. Note: During the vacuum distillation process, no nitrogen purge should be used.

**Step 2: Preparation ethyl 2-ethylthioethyl methylphosphonite**

Note: All flasks, and apparatus should be flushed with nitrogen before each process (to remove oxygen), and all apparatus should be equipped with nitrogen purge and mercury bubblers to keep air out. Into a standard distillation apparatus, equipped with a nitrogen purge and a mercury bubbler, place 31 grams of diethyl methylphosphonite (prepared in step 1), followed by 24 grams of 2-ethylthioethanol. Thereafter, slowly heat the reaction mixture to 80 Celsius while stirring the reaction mixture. Note: During the distillation, ethanol will steadily distill over. Continue to heat and stir the reaction mixture at 80 Celsius until about 10 grams of ethanol is distilled over. After about 10 grams of ethanol has been collected, remove the heat source, and allow the reaction mixture to cool to room temperature. Note: During the cool down period, continue the nitrogen purge Then place the reaction mixture into a

clean vacuum distillation apparatus, and vacuum distil at 40 Celsius under an extreme vacuum of 0.040 millimeters of mercury to obtain a refined product of ethyl 2-ethylthioethyl methylphosphonite. Note: During the vacuum distillation process do not use a nitrogen purge.

Step 3: Preparation of V-sub x

Assemble the apparatus in figure 050 (4-0016A), and then place the refined product (obtained in step 2) into the reaction flask. Thereafter, begin a nitrogen purge to maintain an inert atmosphere within the reaction apparatus all throughout the process. Then place the reaction flask into an oil bath filled with ethylene glycol, and gently heat the contents in the reaction flask to 30 Celsius. Then, by use of a powder addition funnel, slowly add 8.3 grams of finely powdered rhombic sulfur over a period of about 30 minutes while stirring the contents of the reaction flask. During the addition, maintain the reaction temperature below 50 Celsius. Note: during the addition of the sulfur, the temperature of the ethylene glycol oil bath may increase above 50 Celsius. To avoid any increase of temperature above 50 Celsius, small pieces of dry ice should be added to the ethylene glycol oil bath; an electric thermometer equipped with an LCD display should be used to monitor the temperature of the ethylene glycol oil bath. After the addition of the sulfur, continue to stir the reaction mixture, and maintain its temperature below 50 Celsius for about an additional 15 minutes. After which, immediately raise the temperature of the ethylene glycol oil bath to 100 Celsius as quickly as possible, but not too quick as to over heat above the recommended 100 celsius mark. Then heat the reaction mixture while stirring for about 15 minutes at 100 Celsius. After heating for 15 minutes, remove the heat source, and allow the reaction mixture to cool to room temperature. Then place the reaction mixture into a clean vacuum distillation apparatus, and vacuum distill the V-sub x under high vacuum and under a temperature of 150 Celsius to obtain a relatively pure V-sub x product. Note: do not use a nitrogen purge when vacuum distilling the V-sub x. **Note: Instead of vacuum distilling the V-sub x, the reaction flask can be removed from the reaction apparatus of figure 050 (4-0016A), and then any where from 50 to 500 milliliters of methylene chloride, ether, or any other desired solvent can be added to dissolve the V-sub x product. This resulting mixture containing the desired solvent and the V-sub x can then be evaporated under mild vacuum, or distilled at 40 Celsius (if using methylene chloride) to remove the solvent, and leave behind a refined V-sub x product (well suitable for warfare use), or can be used as such in chemical warfare operations when properly disseminated.**

# Section VI

## EXPERIMENTAL CHEMICAL WARFARE

### Chapter 11: The preparation of experimental chemical warfare agents

#### Overview

Experimental chemical warfare agents are a class of a highly lethal chemical compounds that contain quaternary “nitrogen” ions. A great many quaternary nitrogen compounds are known, but most of them are relatively non-toxic in nature, and have in no way the toxicities of the quaternary compounds that will be discussed in this section. In fact, a few quaternary compounds are used as nerve agent antidotes.

The quaternary nitrogen compounds in this section are deadly agents that act upon the peripheral autonomic cholinergic nervous system, which includes the motor nerves, preganglionic fibers, ganglia, and neuromuscular functions. These quaternary nitrogen compounds are in general highly active towards the aforementioned bodily systems because of their “onium” centers, and they are attracted to the anionic sites in the tissues, especially those situated at cell surfaces and interfaces.

The quaternary nitrogen compounds in this section can induce physiological responses that can mimic or antagonize the actions of acetylcholine. They interact with the various physiological receptor sites of acetylcholine, especially those at membranes of muscle cells. These quaternary nitrogen compounds can also combine with enzymes such as acetylcholinesterase, additional esterases, acetylcholineacetylase, and more; as a result, the quaternary nitrogen compounds inhibit the biological processes of the aforementioned.

One of the contributing factors to the toxicity of these experimental compounds is the anatomical differences between the neuromuscular junctions and other acetylcholine receptive sites, and the comparative ease at which they penetrate the membrane barriers or sheaths such as the envelopes of the ganglia, and act upon the neuromuscular junctions replacing normal system processes with “onium” centers; thus greatly interfering with the natural biological processes. This partly explains why in many cases, only very small doses are needed evoke physiological actions that modify or interrupt normal neuromuscular impulse transmission. In essence, the quaternary compounds in this section act in a similar manner as nerve agents, but with more complex reactions, and rates of neuro disruption.

Many quaternary nitrogen compounds differ in their physiological effects, as previously stated, some are used as nerve agent antidotes. They interfere with the neurological mechanisms of impulse transmission in many different ways, and the final physiological effects can vary considerably. Some quaternary nitrogen compounds are used to treat various medical illnesses, and in various types of medical therapies, but a few, like the ones discussed in this section are highly lethal. The magnitude and ease at which these toxic quaternary nitrogen compounds interfere with neurological systems depends on the accessibility, and distribution of the positive charges of the quaternary nitrogen’s themselves. Different physiological behaviors have been observed by different quaternary compounds. In the case of those quaternary compounds discussed in this section, they have the perfect size, shape, charge, and accessibility that make them so lethal.

The nature of the groups attached to the quaternary nitrogen’s influences their distribution and cationic charges. The length and branching of these groups ultimately leads to ease or difficulty in which they approach the specific receptor sites. The groups located upon the “onium” centers in the chemical agents discussed in this book, are perfect for interaction with the esteratic sites of various enzymes; as a result, they have high potency, and toxicity because of their ability to penetrate cell membranes and attack the receptor sites interfering with neurological transmission.

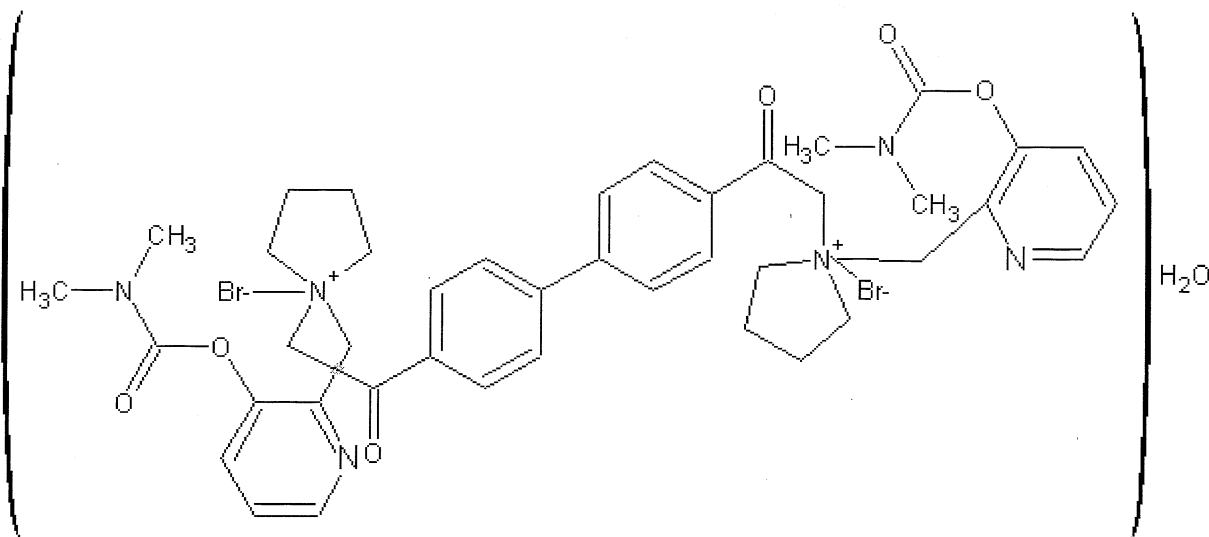
The receptor sites are located in close vicinity to the positively charged “onium” centers of the quaternary nitrogen compounds. Substitution of different functional groups within the quaternary nitrogen’s may give rise to different functions, and may change the interactions with the receptors. Bis-quaternary and poly-quaternary compounds may have different electrical charge balances, as a result, to large of substitutional groups, or inadequate alkyl or aryl groups may disrupt the experimental chemical warfare agents ability to penetrate into the body efficiently. In some cases, certain quaternary nitrogen compounds undergo reversible reactions within the body, therefore leading to decreased toxicities. The chemical agents discussed in this section have been chosen for their regioselectivity, and non-reversible reaction nature, lending them to high potency and toxicity.

In general, the chemical agents discussed in this section interfere with the normal neurological processes leading to severe disruption in the neuromuscular impulse transmissions, and thus interfering with the propagation of impulses from nerves to muscles. Signs and

Chapter 11: The preparation of experimental chemical warfare agents

symptoms of exposure to these agents is similar in nature to the nerve agents, but includes an additional arsenal of incapacitation symptoms including muscle “lock ups”, meaning the muscles tense up or “freeze” making movement almost impossible, total and complete memory loss, severe vision problems, spasms, severe decreases in the ability to think and talk, seizures, drooling, runny nose, and complete loss of bodily functions. The effects from long term exposure to non-lethal concentrations has not been thoroughly researched. Exposure to lethal concentrations is easily fatal within 10 to 90 minutes of exposure, but in many cases, victims will be comatized or even catatonic for days prior to death—this effect can render a severe strain upon military and/or civilian medical and rescue personnel in the event of an attack by these chemical warfare agents. Currently there are no antidotes or methods of treatment for exposure to these experimental chemical warfare agents.

**11-001. Chemical agent 4-692-530-01. bis{α-[(3-dimethylcarbamoy-α-picolinyl)pyrrolidinio]}-4,4'-biacetophenone dibromide monohydrate**



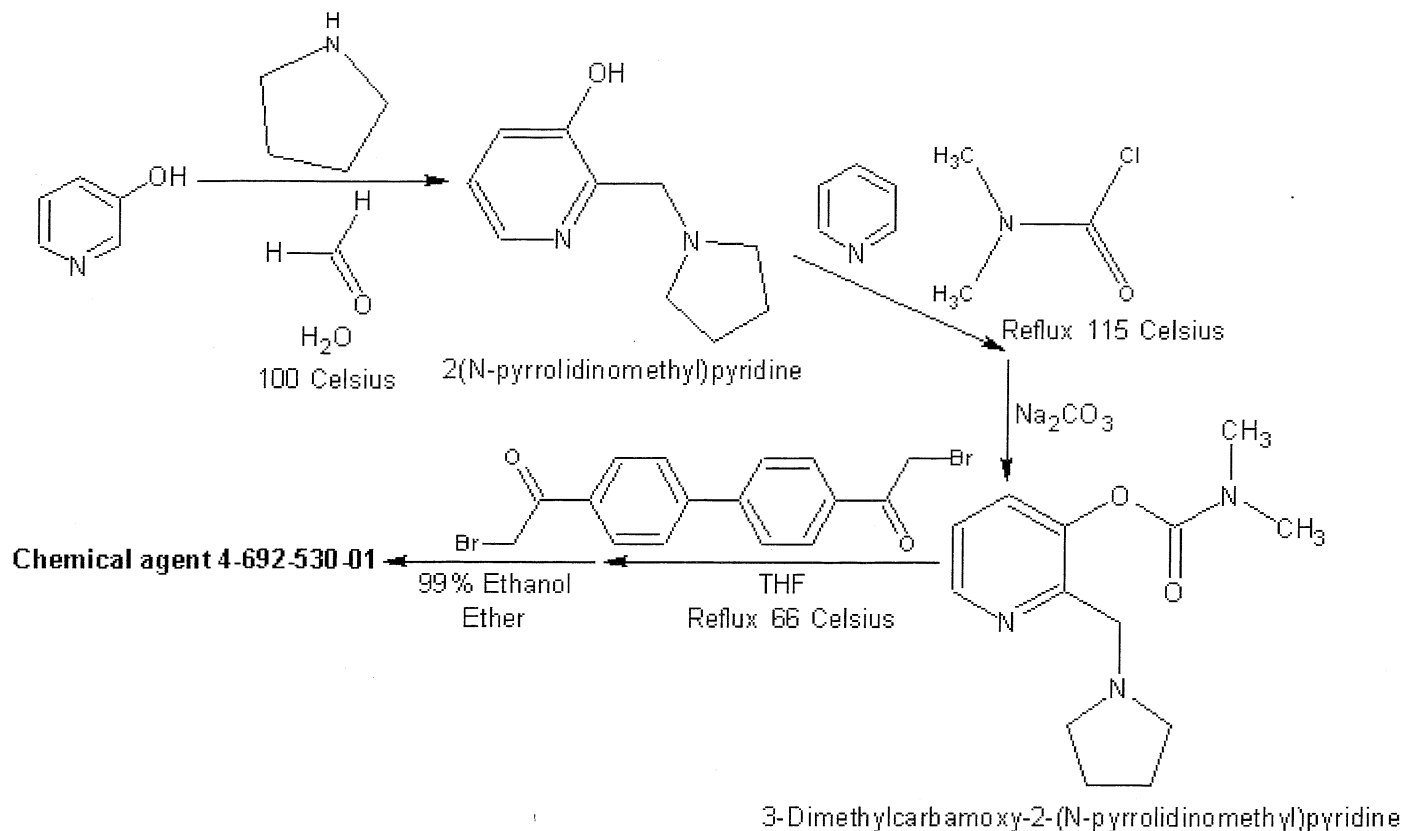
Chemical agent 4-692-530-01

Chemical agent 4-692-530-01 forms a white to colorless or off-white solid with a melting point of 138 Celsius (with decomposition). In some cases, chemical agent 4-692-530-01 may be lightly colored amber or brown, and may have a melting point of 134 Celsius. Chemical agent 4-692-530-01 is a highly toxic agent capable of disrupting nerve transmissions, and causing incapacitation and death. The agent is extremely toxic, and is more toxic than the nerve agents. Currently this agent is not being used in chemical warfare munitions, but its place among the future of chemical warfare is definite. Chemical agent 4-692-530-01 may be used in small arms munitions for tactical or covert operations. Chemical agent 4-692-530-01 can be disseminated using aerosols, smoke generating munitions, or explosives munitions. If smoke generating devices are used, the fuel component should be low burning, and the agent should be in excess as to avoid excessive decomposition. The persistence of chemical agent 4-692-530-01 is dependent on environmental conditions, but ranges from poor to mild. Because it's a solid, its persistence is similar to the riot control agent CS, but its toxicity is so high that it can linger on walls, equipment, clothing, branches, leaves, water, and anything else for very long periods of time and still remain a major threat for months. The agent is rapidly absorbed by the eyes, respiratory tract, and skin. Chemical agent 4-692-530-01 can be decontaminated with bleach, hot potassium permanganate solution, or hot caustic soda solution. **Chemical agent 4-692-530-01 is a fast acting, and highly lethal chemical agent capable of producing casualties within minutes of dissemination. The lethal dose through inhalation in the average man may be as low as 700 micrograms, but usually ranges from 1.2 to 2 milligrams. Inhalation of non-lethal concentrations in the range of 50 to 500 micrograms may produce incapacitation within minutes. The agent has little or no irritating effect upon inhalation, ingestion, or eye and skin absorption.**

<b>OVERALL RATING (scale from 1 to 10)</b>	
<i>Effectiveness (as specialty nerve agent): 10</i>	<i>Field Stability: 10</i>
<i>Persistence (open area): 10</i>	<i>Storage stability: 10</i>
<i>Persistence (enclosed area): 10</i>	<i>Toxicity (as specialty nerve agent): 10</i>
<b>TOTAL EFFECTIVENESS (as specialty nerve agent): 10</b>	
<b>OVERALL TOXICITY (as warfare agent): 10</b>	

Chapter 11: The preparation of experimental chemical warfare agents  
**Procedure 11-001A: Preparation of Chemical agent 4-692-530-01**

**Summary:** Chemical agent 4-692-530-01 can be prepared in a three-step process starting with the formation of 2-(N-pyrrolidinomethyl) pyridine. This intermediate is prepared by reacting 3-pyridol with pyrrolidine in the presence of concentrated formaldehyde solution. Water is added to the reaction mixture to dilute the formaldehyde solution, and the resulting diluted solution is then refluxed for 2 hours at 100 Celsius. The resulting 2-(N-pyrrolidinomethyl) pyridine is then collected by double distillation under high vacuum. Step 2 involves the preparation of 3-Dimethylcarbamoxy-2-(N-pyrrolidinomethyl) pyridine, which is accomplished by reacting the 2-(N-pyrrolidinomethyl) pyridine with dimethylcarbamoyl chloride in the presence of pyridine under reflux. After the reflux period, the resulting reaction mixture is cooled on ice, and then treated with sodium carbonate to liberate the free base from the hydrogen chloride salt. The free base is then recovered by extraction of the entire reaction mixture with chloroform, followed by mild vacuum distillation to remove the chloroform. After the chloroform has been removed, the remaining residue is vacuum distilled twice, to recover the desired 3-Dimethylcarbamoxy-2-(N-pyrrolidinomethyl) pyridine. Step 3 involves the condensation of 3-Dimethylcarbamoxy-2-(N-pyrrolidinomethyl) pyridine with  $\alpha,\alpha'$ -dibromo-4,4'-biacetophenone in the presence of tetrahydrofuran (THF) under reflux. The resulting precipitated product is then dissolved in ethyl alcohol, mixed with charcoal (for purification), and then precipitated by the addition of ether. The re-precipitated product is then vacuum dried or air-dried, and then stored in a desiccator filled with phosphorus pentoxide. Note: This entire process is similar or related to the process discussed in application number 624,649, March 7<sup>th</sup>, 1967 by Harold Z. Sommer, of Havre de Grace, MD; assigned by the United States Army. This process may be protected by industrial/commercial process applications. Consult said application number before using the mentioned process for commercial or industrial purposes.



*Reaction Equation (by-products omitted)*

<b>Materials:</b>	1. 57 grams 3-pyridol	8. 100 grams of anhydrous sodium sulfate
	2. 45.5 grams of pyrrolidine	9. 500 milliliters of dry tetrahydrofuran
	3. 53.5 grams of a 37% formaldehyde	10. 16 grams of $\alpha,\alpha'$ -dibromo-4,4'-biacetophenone
	4. 64 milliliters of pyridine	11. 150 milliliter of 99% ethanol
	5. 41 grams of dimethylcarbamoyl chloride	12. 15 grams of regular charcoal
	6. 500 milliliters of a 25% sodium carbonate solution	13. 150 milliliters of dry ethyl ether
	7. 900 milliliters of chloroform	

**Hazards:**





## **WARNING! WARNING! WARNING! WARNING! WARNING!**

Do not attempt in anyway to prepare chemical agent 4-692-530-01 using the following procedure unless proper safety precautions are taken. 1) Perform all operations in a clean box, which is treated with a nitrogen atmosphere, and in which is completely sealed from the air. 2) After each procedure, all glassware and non-electric equipment should be soaked in a bleach (sodium hypochlorite) solution before removing from the clean box. Any electrical equipment such as hot plates and stirring equipment should be carefully wiped down with a bleached soaked rag before removing from the clean box. 3) After the entire operation is complete, the entire clean box should be disinfected with bleach before opening the clean box to the air. 4) The desired chemical agent 4-692-530-01 should be stored in amber bottles, preferably non-breakable containers, and stored in a cool dry place away from sunlight. The bottles should also be placed inside an airtight sealed plastic bag, such as a 'ziplock' bag. 5) Storage of this agent should be in airtight cabinets, drawers, or the like, and said storage spaces should be equipped with chemical agent detection monitors to alert of any potential leakage.

3-Pyridol, pyrrolidine, pyridine, charcoal, and 99% ethanol are flammable, so extinguish all flames before using. Tetrahydrofuran, and diethyl ether are highly flammable and explosive, handle with care and perform the peroxide test before using. Use care when handling  $\alpha,\alpha'$ -dibromo-4,4'-biacetophenone, which is irritating to the nose and throat. Dimethylcarbonyl chloride is irritating and corrosive, use caution when handling, and avoid inhalation of the fumes. 37% Formaldehyde solution is a very volatile liquid, so avoid inhalation of the vapors.

### **Procedure:**

#### Step 1: Preparation of 2-(N-pyrrolidinomethyl) pyridine

Into a standard reflux apparatus, add 57 grams 3-pyridol, 45.5 grams of pyrrolidine, 53.5 grams of a 37% formaldehyde solution, and 100 milliliters of water. Thereafter, reflux this entire mixture for about 2 hours at 100 Celsius using a steam bath as the external heating source. After the reflux period, allow the mixture to cool to room temperature, and then pour the entire reaction mixture into a vacuum distillation apparatus, and fractionally distill the reaction mixture at 140 Celsius under a vacuum of 3.5 millimeters of mercury to obtain a crude product. After the distillation process, place the crude product into a clean vacuum distillation apparatus, and re-distill the crude product at 110 Celsius under a vacuum of 2 millimeters of mercury to obtain 65 grams of a refined product of 2-(N-pyrrolidinomethyl) pyridine.

#### Step 2: Preparation of 3-Dimethylcarbamoxy-2-(N-pyrrolidinomethyl) pyridine

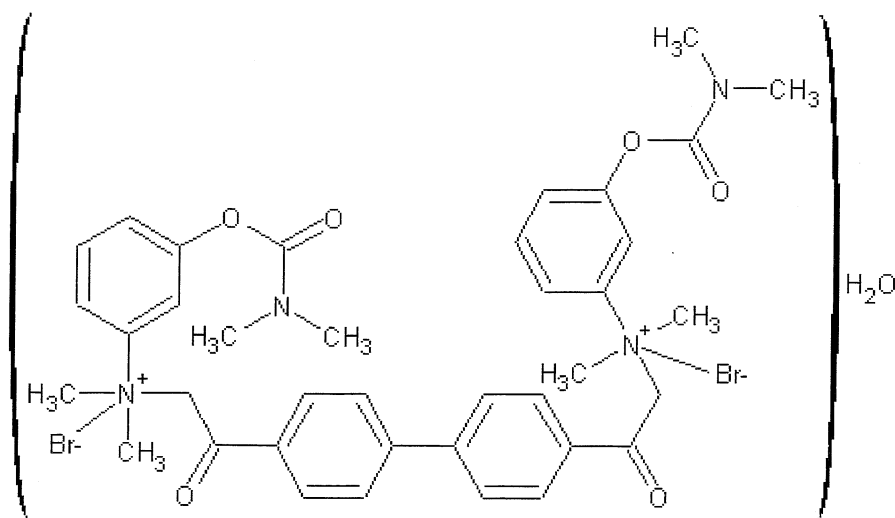
Into a clean reflux apparatus, place the 65 grams of the refined product obtained in step1, followed by 64 milliliters of pyridine, and 41 grams of dimethylcarbonyl chloride. Thereafter, reflux the entire reaction mixture for 60 minutes at 115 Celsius. After refluxing for 60 minutes, remove the heat source, and allow the reaction mixture to cool to room temperature. Then pour the entire reaction mixture onto 100 grams of ice contained in a beaker. Allow the ice to melt, and then add in 500 milliliters of a 25% sodium carbonate solution, and stir the reaction mixture for 30 minutes. After the addition of sodium carbonate (to neutralize the hydrochloride base), extract the entire mixture with six 150-milliliter portions of dry chloroform. After the extraction process, combine all chloroform extracts (if not already done so), and then dry the combined chloroform extracts by adding 100 grams of anhydrous sodium sulfate and stirring the mixture for 10 minutes; thereafter, filter-off the sodium sulfate. Then place the entire filtered chloroform mixture into a clean rotary evaporator or vacuum distillation apparatus, and remove the chloroform under mild vacuum. Thereafter, place the remaining residue into a clean vacuum distillation apparatus, and vacuum distill at 130 Celsius and under a vacuum of 1.6 millimeters of mercury to obtain a crude product. Then place this crude product into a clean vacuum distillation apparatus, and re-distill the crude product at 117 Celsius, and under a vacuum of 0.08 millimeters of mercury to obtain 24.5 grams of a refined 3-Dimethylcarbamoxy-2-(N-pyrrolidinomethyl)pyridine.

#### Step 3: Preparation of chemical agent 4-692-530-01

Into a clean reflux apparatus place 500 milliliters of dry tetrahydrofuran, and then 16 grams of  $\alpha,\alpha'$ -dibromo-4,4'-biacetophenone. Thereafter, stir the mixture for several minutes to dissolve the solids. Then add 20 grams of the product obtained in step 2, and then reflux the entire reaction mixture at 66 Celsius for 4 hours. After refluxing the reaction mixture for 4 hours, remove the heat source, and allow the reaction mixture to cool to room temperature. Then filter-off the precipitated product, and then dissolve this precipitated

product into 150 milliliters of 99% ethanol. Note: More or less 99% ethanol may or may not be needed to dissolve the precipitated product. When the filtered-off precipitated product has dissolved in the 99% ethanol, add in 15 grams of regular charcoal, and then stir the whole mixture for 10 minutes. After 10 minutes, filter-off the insoluble charcoal, and then add 150 milliliters of dry ethyl ether. Note: More or less diethyl ether may or may not be needed. After the addition of the diethyl ether, the purified product will precipitate. Allow this ethanol/ether mixture to stand for 1 hour at room temperature (to allow for the product to precipitate fully), and then filter-off the precipitated product. Then carefully vacuum dry or air-dry this filtered-off product, and then store it in a desiccator filled with phosphorus pentoxide for 12 hours. The result will be about 15 grams of the desired chemical agent 4-692-530-01.

### 11-002. Chemical agent 4-692-530-02. bis{ $\alpha$ -[(3-dimethylcarbamoylphenyl)methylamino]}-4,4'-biacetophenone dimethobromide monohydrate



Chemical agent 4-692-530-02

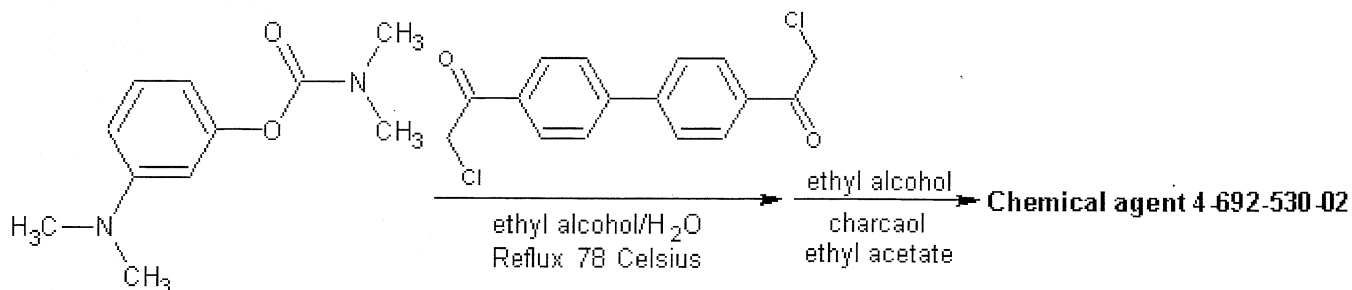
Chemical agent 4-692-530-02 forms a light yellowish to off-white odorless solid with a melting point of 152 Celsius. In some cases the solid may have a light amber or faded tint to it, with a characteristic, yet mild odor. Chemical agent 4-692-530-02 is very similar in nature to chemical agent 4-692-530-01. It can be used in chemical warfare operations with lethal results. Chemical agent 4-692-530-02 is a highly lethal chemical agent capable of incapacitating and killing exposed personnel within moments. The agent is rapidly absorbed by the eyes, respiratory tract, and skin. Currently, it is not being used in military munitions, but its future in chemical warfare is definite. It may currently be used in tactical and covert munitions such as grenades and land mines. Its persistence is similar to chemical agent 4-692-530-01, and it can linger on clothing, walls, equipment, leaves, branches and other objects from which it can remain a lethal threat for months. It can be effectively disseminated through aerosols, smoke generating munitions, or explosives munitions. If smoke generating devices are used, the fuel component should be low burning, and the agent should be in excess as to avoid excessive decomposition. Chemical agent 4-692-530-02 can be decontaminated with bleach, or hot caustic alkali. **Chemical agent 4-692-530-02 is a fast acting, and highly lethal chemical agent capable of producing casualties within minutes of dissemination. The agent is highly toxic through inhalation, ingestion, and eye and skin absorption. The lethal dose through inhalation in the average man may be as low as 900 micrograms, but usually ranges from 1.8 to 2.2 milligrams. Inhalation of non-lethal concentrations in the range of 120 to 800 micrograms may produce incapacitation within minutes. The agent has little or no irritating effect upon inhalation, ingestion, or eye and skin absorption.**

OVERALL RATING (scale from 1 to 10)	
<i>Effectiveness (as specialty nerve agent):</i> 10	<i>Field Stability:</i> 10
<i>Persistence (open area):</i> 10	<i>Storage stability:</i> 10
<i>Persistence (enclosed area):</i> 10	<i>Toxicity (as specialty nerve agent):</i> 9
TOTAL EFFECTIVENESS (as specialty nerve agent): 9.8	
OVERALL TOXICITY (as warfare agent): 9½	

#### Procedure 11-002A: Preparation of Chemical agent 4-692-530-02

Chapter 11: The preparation of experimental chemical warfare agents

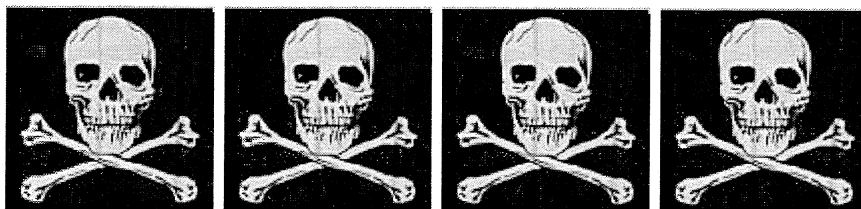
**Summary:** Chemical agent 4-692-530-02 is prepared in a simple one step process by the condensation of 3-dimethylcarbamoyldimethylaniline with  $\alpha,\alpha'$ -dibromo-4,4'-biacetophenone under reflux, and in the presence of ethyl alcohol and water. The reflux process takes about 35 hours, and afterwards, the resulting reaction mixture is stripped of solvent and water, and then treated with charcoal for purification. The purified mixture is then filtered, to remove the charcoal, and then treated with ethyl acetate and then stored in a refrigerator to allow all the product to precipitate. The precipitated product is then easily recovered by filtration, and then dried. Note: This entire process is similar or related to the process discussed in application number 624,649, March 7<sup>th</sup>, 1967 by Harold Z. Sommer, of Havre de Grace, MD; assigned by the United States Army. This process may be protected by industrial/commercial process applications. Consult said application number before using the mentioned process for commercial or industrial purposes.



*Reaction Equation (by-products omitted)*

<b>Materials:</b>	1. 600 milliliters of 95% ethyl alcohol	4. 300 milliliters of 99% ethyl alcohol
	2. 22 grams of 3-dimethylcarbamoyldimethylaniline	5. 10 grams of regular charcoal
	3. 11.8 grams of $\alpha,\alpha'$ -dibromo-4,4'-biacetophenone	6. 300 milliliters of ethyl acetate

**Hazards:**



**WARNING! WARNING! WARNING! WARNING!**

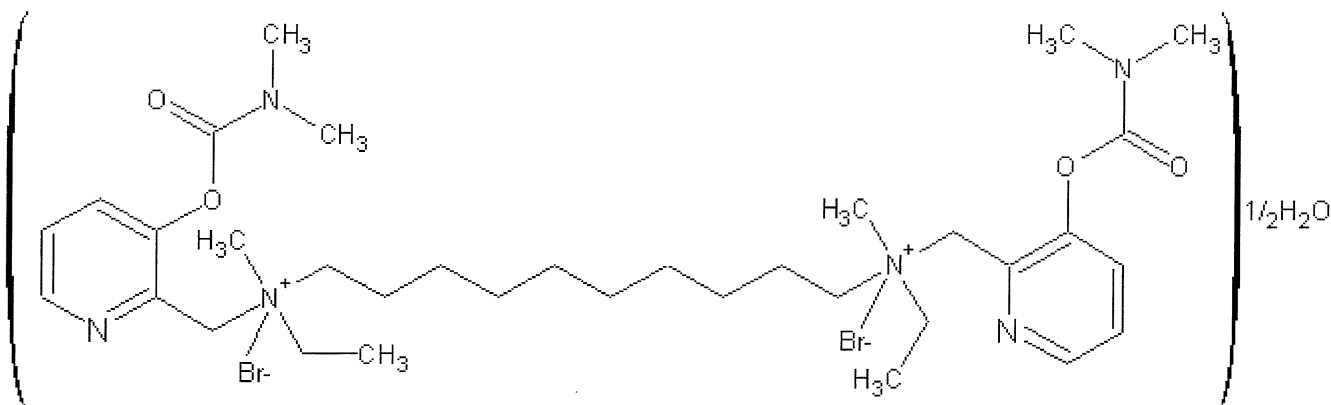
Do not attempt in anyway to prepare chemical agent 4-692-530-02 using the following procedure unless proper safety precautions are taken. 1) Perform all operations in a clean box, which is treated with a nitrogen atmosphere, and in which is completely sealed from the air. 2) After each procedure, all glassware and non-electric equipment should be soaked in a bleach (sodium hypochlorite) solution before removing from the clean box. Any electrical equipment such as hot plates and stirring equipment should be carefully wiped down with a bleached soaked rag before removing from the clean box. 3) After the entire operation is complete, the entire clean box should be disinfected with bleach before opening the clean box to the air. 4) The desired chemical agent 4-692-530-02 should be stored in amber bottles, preferably non-breakable containers, and stored in a cool dry place away from sunlight. The bottles should also be placed inside an airtight sealed plastic bag, such as a 'ziplock' bag. 5) Storage of this agent should be in airtight cabinets, drawers, or the like, and said storage spaces should be equipped with chemical agent detection monitors to alert of any potential leakage.

Ethyl alcohol, charcoal, and ethyl acetate are flammable, so extinguish all flames before using. Use care when handling  $\alpha,\alpha'$ -dibromo-4,4'-biacetophenone, which is irritating to the nose and throat.

**Procedure:** Into a suitable reflux apparatus, add 600 milliliters of 95% ethyl alcohol, 1200 milliliters of water, 22 grams of 3-dimethylcarbamoyldimethylaniline, and 11.8 grams of  $\alpha,\alpha'$ -dibromo-4,4'-biacetophenone. Thereafter reflux this entire reaction mixture at 78 Celsius for 35 hours. After the reflux period, remove the heat source, and allow the reaction mixture to cool to room temperature. Then place the entire reaction mixture into a rotary evaporator or vacuum distillation apparatus, and remove the ethyl alcohol and water under vacuum at about 50 millimeters of mercury. Thereafter, remove the remaining oily residue, and dissolve it into 300 milliliters of hot 99% ethyl alcohol. After the oily residue has dissolved, add in 10 grams of regular charcoal, and then stir the entire mixture for about 30 minutes. Then filter-off the charcoal, and any other insoluble materials, and then mix 300 milliliters of ethyl acetate (more or less may be needed) with the filtered ethyl alcohol mixture. Thereafter, place this ethyl acetate/ethyl alcohol

mixture into a refrigerator and allow it to stand over night. The following day, filter-off the precipitated yellowish solid, and then vacuum dry or air-dry this filtered-off solid, and then store it in a desiccator filled with phosphorus pentoxide for 24 hours.

### 11-003. Chemical agent 4-686-293-01. Agent 1-10. 1,10-Bis[(3-dimethylcarbamoyl- $\alpha$ -picolinyl)ethylamino]decane dimethobromide $\frac{1}{2}$ hydrate



Chemical agent 4-686-293-01

Chemical agent 4-686-293-01 forms a crystalline white solid, with a melting point of 173 Celsius. It may have an off-white appearance to it, and sometimes may be colored light yellow to brown. The pure compound has no odor, but impure varieties may have a characteristic light "oily" smell. Chemical agent 4-686-293-01 is a highly potent and lethal nerve agent, which can render exposed personnel incapacitated or dead with microgram quantities. The agent is rapidly absorbed by the eyes, respiratory tract, and skin. Its higher melting point, and extreme toxicity makes it perfect for use in chemical weapons. Currently it is not in active use by military forces. Chemical agent 4-686-293-01 is one of the most lethal chemical warfare agents known to man. Its persistence in the environment is similar to chemical agents 4-692-530-01, and 4-692-530-02, but it is more persistent; it can remain embedded in clothing and other garments, and it can linger on walls, branches, grass, trees, and equipment of all kinds from which it can remain a lethal threat for months. It can be disseminated using aerosols, smoke generating munitions, or explosives munitions. The agent can be decontaminated with bleach, or hot caustic soda. **Chemical agent 4-686-293-01 is a fast acting and lethal chemical warfare agent capable of producing casualties within minutes of dissemination. The agent is highly toxic through inhalation, ingestion, and eye and skin absorption. The lethal dose through inhalation in the average man is as low as 320 micrograms, but ranges from 500 to 900 micrograms. Inhalation, ingestion, or eye/skin absorption of as little as 5 to 50 micrograms can lead to incapacitation. The agent has little or no irritating effect upon inhalation, ingestion, or eye and skin absorption.**

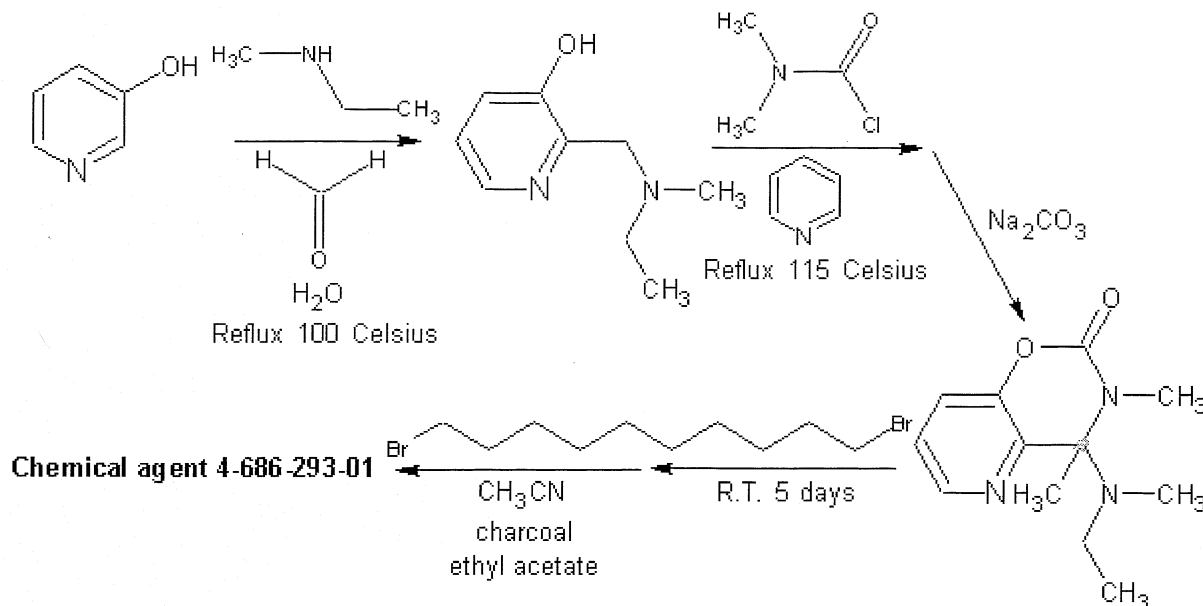
OVERALL RATING (scale from 1 to 10)	
<i>Effectiveness (as specialty nerve agent):</i> 10	<i>Field Stability:</i> 10
<i>Persistence (open area):</i> 10	<i>Storage stability:</i> 10
<i>Persistence (enclosed area):</i> 10	<i>Toxicity (as specialty nerve agent):</i> 10
<b>TOTAL EFFECTIVENESS (as specialty nerve agent): 10</b>	
<b>OVERALL TOXICITY (as warfare agent): 10</b>	

#### Procedure 11-003A: Preparation of Chemical agent 4-686-293-01

**Summary:** Chemical agent 4-686-293-01 is prepared in a three step process starting with the formation of 2-{{[ethyl(methyl)amino]methyl}pyridin-3-ol. This intermediate compound is prepared by reacting 3-pyridol with ethylmethylamine in the presence of concentrated formaldehyde and water under reflux. The resulting product is then collected by double distillation under high vacuum. Step 2 involves the formation of (3-dimethylcarbamoyl- $\alpha$ -picolinyl)-methyl ethylamine, which is accomplished by interacting 2-{{[ethyl(methyl)amino]methyl}pyridin-3-ol with dimethylcarbamoyl chloride in the presence of pyridine, and under reflux conditions. The desired (3-dimethylcarbamoyl- $\alpha$ -picolinyl)-methyl ethylamine is then collected by treating the reaction mixture with sodium carbonate (to neutralize the hydrochloride salt), extraction of the reaction mixture with chloroform, stripping the chloroform solvent, and then vacuum distilling the remaining residue under high vacuum. Step 3 involves the conversion of (3-dimethylcarbamoyl- $\alpha$ -picolinyl)-methyl ethylamine into the desired chemical agent 4-686-293-01 by reacting (3-dimethylcarbamoyl- $\alpha$ -picolinyl)-methyl ethylamine with 1,10-dibromodecane at room temperature for 5 days. The resulting reaction mixture is then triturated with 200 milliliters of acetone, followed by filtering-off the insoluble crude product. The insoluble crude product is then dissolved into hot acetonitrile, treated with charcoal (to absorb impurities), followed by precipitation by the addition of ethyl acetate.

Chapter 11: The preparation of experimental chemical warfare agents

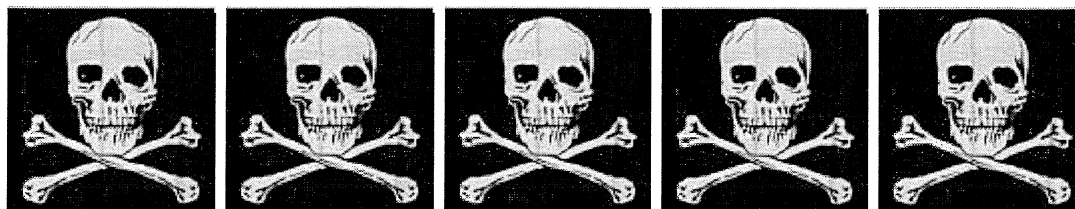
The precipitated product is then collected by filtration, dried, and then stored in a desiccator filled with phosphorus pentoxide for 12 hours. Note: This entire process is similar or related to the process discussed in application number 643,302 March 29<sup>th</sup>, 1967 by Harold Z. Sommer, of Havre de Grace, MD, and Omer O. Owens, Abingdon, MD; assigned by the United States Army. This process may be protected by industrial/commercial process applications. Consult said application number before using the mentioned process for commercial or industrial purposes.



Reaction equation (by-products omitted)

<b>Materials:</b>	1. 57 grams 3-pyridol	8. 100 grams of anhydrous sodium sulfate
	2. 36 grams of ethylmethylamine	9. 18 grams of 1,10-dibromodecane
	3. 53.5 grams of a 37% formaldehyde solution	10. 200 milliliters of acetone
	4. 64 milliliters of pyridine	11. 200 milliliters of hot acetonitrile
	5. 44 grams of dimethylcarbamoyl chloride	12. 15 grams of charcoal
	6. 500 milliliters of a 25% sodium carbonate solution	13. 200 milliliters of ethyl acetate
	7. 900 milliliters of chloroform	

**Hazards:**



**WARNING! WARNING! WARNING! WARNING! WARNING!**

Do not attempt in anyway to prepare chemical agent 4-686-293-01 using the following procedure unless proper safety precautions are taken. 1) Perform all operations in a clean box, which is treated with a nitrogen atmosphere, and in which is completely sealed from the air. 2) After each procedure, all glassware and non-electric equipment should be soaked in a bleach (sodium hypochlorite) solution before removing from the clean box. Any electrical equipment such as hot plates and stirring equipment should be carefully wiped down with a bleached soaked rag before removing from the clean box. 3) After the entire operation is complete, the entire clean box should be disinfected with bleach before opening the clean box to the air. 4) The desired chemical agent 4-686-293-01 should be stored in amber bottles, preferably non-breakable containers, and stored in a cool dry place away from sunlight. The bottles should also be placed inside an airtight sealed plastic bag, such as a 'ziplock' bag. 5) Storage of this agent should be in airtight cabinets, drawers, or the like, and said storage spaces should be equipped with chemical agent detection monitors to alert of any potential leakage.

3-pyridol, pyridine, charcoal, and ethyl acetate are flammable so extinguish all flames before using. 37% formaldehyde is a highly volatile substance, avoid inhalation of the vapors. Dimethylcarbamoyl chloride is irritating to

Chapter 11: The preparation of experimental chemical warfare agents  
the nose and throat, so avoid vapor contact. Acetone is highly flammable, extinguish all flames before using. Acetonitrile is very toxic, so avoid skin contact and inhalation of vapors.

### Procedure:

#### Step 1: Preparation of 2-{{ethyl(methyl)amino}methyl}pyridin-3-ol

Into a standard reflux apparatus, add 57 grams 3-pyridol, 36 grams of ethylmethylamine, 53.5 grams of a 37% formaldehyde solution, and 100 milliliters of water. Thereafter, reflux this entire mixture for about 2 hours at 100 Celsius using a steam bath as the external heating source. After the reflux period, allow the mixture to cool to room temperature, and then pour the entire reaction mixture into a vacuum distillation apparatus, and fractionally distill the reaction mixture at 130 Celsius under a vacuum of 1.00 millimeters of mercury to obtain a crude product. After the distillation process, place the crude product into a clean vacuum distillation apparatus, and re-distill the crude product at 117 Celsius under a vacuum of 1 millimeters of mercury to obtain a refined product of 2-{{ethyl(methyl)amino}methyl}pyridin-3-ol.

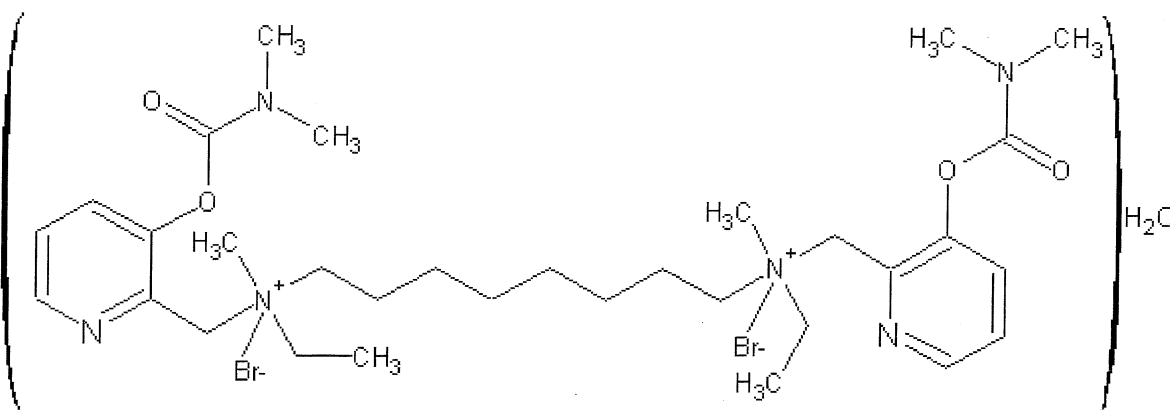
#### Step 2: Preparation of (3-dimethylcarbamoxy- $\alpha$ -picolinyl)-methyl ethylamine

Into a clean reflux apparatus, place the 65 grams of refined product obtained in step 1, followed by 64 milliliters of pyridine, and 44 grams of dimethylcarbamoyl chloride. Thereafter, reflux the entire reaction mixture for 60 minutes at 115 Celsius. After refluxing for 60 minutes, remove the heat source, and allow the reaction mixture to cool to room temperature. Then pour the entire reaction mixture onto 100 grams of ice contained in a beaker. Allow the ice to melt, and then add in 500 milliliters of a 25% sodium carbonate solution, and stir the reaction mixture for 30 minutes. After the addition of sodium carbonate (to neutralize the hydrochloride base), extract the entire mixture with six 150-milliliter portions of dry chloroform. After the extraction process, combine all chloroform extracts (if not already done so), and then dry the combined chloroform extracts by adding 100 grams of anhydrous sodium sulfate and stirring the mixture for 10 minutes; thereafter, filter-off the sodium sulfate. Then place the entire filtered chloroform mixture into a clean rotary evaporator or vacuum distillation apparatus, and remove the chloroform under mild vacuum. Thereafter, place the remaining residue into a clean vacuum distillation apparatus, and vacuum distill at 160 Celsius and under a vacuum of 2 millimeters of mercury to obtain a crude product. Then place this crude product into a clean vacuum distillation apparatus, and re-distill the crude product at 138 Celsius, and under a vacuum of 2 millimeters of mercury to obtain a refined (3-dimethylcarbamoxy- $\alpha$ -picolinyl)-methyl ethylamine.

#### Step 3: Preparation of chemical agent 4-686-293-01

Into a suitable flask, place 28 grams of the product obtained in step 2, followed by 18 grams of 1,10-dibromodecane. Then allow this reaction mixture to stand for 5 days at room temperature. During this standing period, the reaction mixture will solidify. After allowing the reaction mixture to stand for 5 days, mix in 200 milliliters of acetone, and then stir the whole reaction mixture for about 15 minutes. Thereafter, filter-off the insoluble solids, and then dissolve these insoluble solids into 200 milliliters of hot acetonitrile. After the bulk of the solids have dissolved, add in 15 grams of charcoal, and then stir the whole mixture for about 10 minutes. Then before the acetonitrile cools down, filter-off the charcoal, and any insoluble solids, and then add this filtered acetonitrile mixture to about 200 milliliters of ethyl acetate (more or less ethyl acetate may or may not be needed). During and after the addition of the ethyl acetate, the mixture will become turbid in nature. After the addition of the ethyl acetate, allow the entire mixture to stand overnight at room temperature. The next day, filter-off the precipitated product, and then vacuum dry or air dry it, and then store it in a desiccator filled with phosphorus pentoxide for 12 hours.

### 11-004. Chemical agent 4-686-293-02. Agent 1-8. 1,8-Bis[(3-dimethylcarbamoxy- $\alpha$ -picolinyl)ethylamino]octane dimethobromide monohydrate



## Chemical agent 4-686-293-02

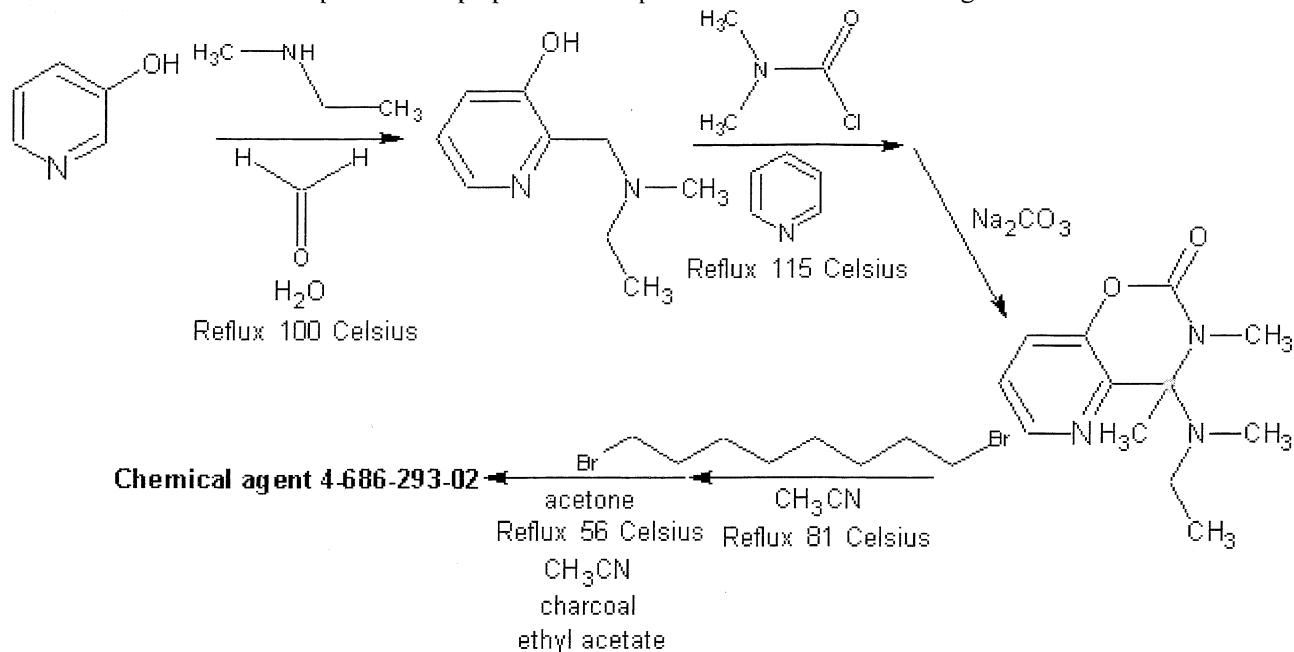
Chemical agent 4-686-293-02 forms a colorless to white crystalline solid with a melting point of 139 Celsius. Impure forms may be off white or light amber to brown in color, and may have a slight odor of almonds, or burnt garlic. The pure compound is odorless, and gives off a colorless to white vapor upon volatilization. Chemical agent 4-686-292-02 is stable and its persistence is very good. Like the other experimental agents, it can linger on clothing, equipment, leaves, trees, and the like from which it can remain a major threat for months. Chemical agent 4-686-293-02 is one of the most toxic chemical warfare agents known to man. The agent is highly toxic through inhalation, ingestion, and eye and skin absorption. It's not currently under military use, but like the others, its future in chemical warfare is definite. The agent can be disseminated under the usual techniques, but its low melting point makes it less satisfactory for use in smoke generating munitions; although it can be used in smoke generating munitions as long as the fuel component is low burning, and the chemical agent is in excess. Chemical agent 4-686-293-02 can be decontaminated with bleach, or hot caustic soda. **Chemical agent 4-686-293-02 is a fast acting and lethal chemical warfare agent capable of producing casualties within minutes of dissemination. The agent is highly toxic through inhalation, ingestion, and eye and skin absorption. The lethal dose through inhalation in the average man is as low as 340 micrograms, but ranges from 550 to 800 micrograms. Inhalation, ingestion, or eye/skin absorption of as little as 5 to 55 micrograms can lead to incapacitation. The agent has little or no irritating effect upon inhalation, ingestion, or eye and skin absorption.**

OVERALL RATING (scale from 1 to 10)	
<i>Effectiveness (as specialty nerve agent):</i> 10	<i>Field Stability:</i> 10
<i>Persistence (open area):</i> 10	<i>Storage stability:</i> 10
<i>Persistence (enclosed area):</i> 10	<i>Toxicity (as specialty nerve agent):</i> 10
TOTAL EFFECTIVENESS (as specialty nerve agent): 10	
OVERALL TOXICITY (as warfare agent): 10	

**Procedure 11-004A: Preparation of Chemical agent 4-686-293-02**

**Summary:** Chemical agent 4-686-293-02 is prepared in a three step process starting with the formation of 2-{{ethyl(methyl)amino}methyl}pyridin-3-ol. This intermediate compound is prepared in an identical manner as in 11-003A, see vide supra. Step 2 involves the formation of (3-dimethylcarbamoxy- $\alpha$ -picolinyl)-methyl ethylamine, which is accomplished in an identical manner as in 11-003A, see vide supra. Step 3 involves the conversion of (3-dimethylcarbamoxy- $\alpha$ -picolinyl)-methyl ethylamine into the desired chemical agent 4-686-293-02 by reacting (3-dimethylcarbamoxy- $\alpha$ -picolinyl)-methyl ethylamine with 1,8-dibromooctane in the presence of acetonitrile under reflux for 2 days. The resulting reaction mixture is then stripped of solvent, and the remaining oily residue is then refluxed with acetone. The resulting mixture is then filtered to remove the insoluble product, and the resulting solid product is then dissolved into acetonitrile and treated with charcoal. After removing the charcoal through filtration, the desired product is then precipitated by the addition of ethyl acetate, and then recovered by filtration. The final product is then dried and then stored in a desiccator filled with phosphorus pentoxide for 12 hours. Note: This entire process is similar or related to the process discussed in application number 643,302 March 29<sup>th</sup>, 1967 by Harold Z. Sommer, of Havre de Grace, MD, and Omer O. Owens, Abingdon, MD; assigned by the United States Army. This process may be protected by industrial/commercial process applications. Consult said application number before using the mentioned process for commercial or industrial purposes.

Chapter 11: The preparation of experimental chemical warfare agents



Reaction Equation (by products omitted)

<b>Materials:</b>	1. 57 grams 3-pyridol	8. 100 grams of anhydrous sodium sulfate
	2. 36 grams of ethylmethylamine	9. 16 grams of 1,8-dibromooctane
	3. 53.5 grams of a 37% formaldehyde solution	10. 200 milliliters of acetone
	4. 64 milliliters of pyridine	11. 500 milliliters of acetonitrile
	5. 44 grams of dimethylcarbonyl chloride	12. 10 grams of charcoal
	6. 500 milliliters of a 25% sodium carbonate solution	13. 200 milliliters of ethyl acetate
	7. 900 milliliters of chloroform	

Hazards:



**WARNING! WARNING! WARNING! WARNING! WARNING!**

Do not attempt in anyway to prepare chemical agent 4-686-293-02 using the following procedure unless proper safety precautions are taken. 1) Perform all operations in a clean box, which is treated with a nitrogen atmosphere, and in which is completely sealed from the air. 2) After each procedure, all glassware and non-electric equipment should be soaked in a bleach (sodium hypochlorite) solution before removing from the clean box. Any electrical equipment such as hot plates and stirring equipment should be carefully wiped down with a bleached soaked rag before removing from the clean box. 3) After the entire operation is complete, the entire clean box should be disinfected with bleach before opening the clean box to the air. 4) The desired chemical agent 4-686-293-02 should be stored in amber bottles, preferably non-breakable containers, and stored in a cool dry place away from sunlight. The bottles should also be placed inside an airtight sealed plastic bag, such as a 'ziplock' bag. 5) Storage of this agent should be in airtight cabinets, drawers, or the like, and said storage spaces should be equipped with chemical agent detection monitors to alert of any potential leakage.

3-pyridol, pyridine, charcoal, and ethyl acetate are flammable so extinguish all flames before using. 37% formaldehyde is a highly volatile substance, avoid inhalation of the vapors. Dimethylcarbonyl chloride is irritating to the nose and throat, so avoid vapor contact. Acetone is highly flammable, extinguish all flames before using. Acetonitrile is very toxic, so avoid skin contact and inhalation of vapors.

Procedure:



## Chapter 11: The preparation of experimental chemical warfare agents

### Step 1: Preparation of 2-[[ethyl(methyl)amino]methyl]pyridin-3-ol

Into a standard reflux apparatus, add 57 grams 3-pyridol, 36 grams of ethylmethylamine, 53.5 grams of a 37% formaldehyde solution, and 100 milliliters of water. Thereafter, reflux this entire mixture for about 2 hours at 100 Celsius using a steam bath as the external heating source. After the reflux period, allow the mixture to cool to room temperature, and then pour the entire reaction mixture into a vacuum distillation apparatus, and fractionally distill the reaction mixture at 130 Celsius under a vacuum of 1.00 millimeters of mercury to obtain a crude product. After the distillation process, place the crude product into a clean vacuum distillation apparatus, and re-distill the crude product at 117 Celsius under a vacuum of 1 millimeters of mercury to obtain a refined product of 2-[[ethyl(methyl)amino]methyl]pyridin-3-ol.

### Step 2: Preparation of (3-dimethylcarbamoxy- $\alpha$ -picolinyl)-methyl ethylamine

Into a clean reflux apparatus, place the 65 grams of refined product obtained in step 1, followed by 64 milliliters of pyridine, and 44 grams of dimethylcarbamoyl chloride. Thereafter, reflux the entire reaction mixture for 60 minutes at 115 Celsius. After refluxing for 60 minutes, remove the heat source, and allow the reaction mixture to cool to room temperature. Then pour the entire reaction mixture onto 100 grams of ice contained in a beaker. Allow the ice to melt, and then add in 500 milliliters of a 25% sodium carbonate solution, and stir the reaction mixture for 30 minutes. After the addition of sodium carbonate (to neutralize the hydrochloride base), extract the entire mixture with six 150-milliliter portions of dry chloroform. After the extraction process, combine all chloroform extracts (if not already done so), and then dry the combined chloroform extracts by adding 100 grams of anhydrous sodium sulfate and stirring the mixture for 10 minutes; thereafter, filter-off the sodium sulfate. Then place the entire filtered chloroform mixture into a clean rotary evaporator or vacuum distillation apparatus, and remove the chloroform under mild vacuum. Thereafter, place the remaining residue into a clean vacuum distillation apparatus, and vacuum distill at 160 Celsius and under a vacuum of 2 millimeters of mercury to obtain a crude product. Then place this crude product into a clean vacuum distillation apparatus, and re-distill the crude product at 138 Celsius, and under a vacuum of 2 millimeters of mercury to obtain a refined (3-dimethylcarbamoxy- $\alpha$ -picolinyl)-methyl ethylamine.

### Step 3: Preparation of chemical agent 4-686-293-02

Into a suitable reflux apparatus, place 28 grams of the product obtained in step 2, followed by a solution prepared by adding and dissolving 16 grams of 1,8-dibromooctane into 300 milliliters of acetonitrile. Thereafter, reflux this reaction mixture for 48 hours at 81 Celsius. After refluxing the reaction mixture for 48 hours, remove the heat source, and allow the reaction mixture to cool to room temperature. Then place the entire reaction mixture into a rotary evaporator, and remove the acetonitrile under mild vacuum and heat. After the acetonitrile has been removed, take the remaining oily residue and place it into 200 milliliters of acetone. Thereafter, reflux this new mixture for about 20 minutes at 56 Celsius. After this short reflux period, remove the heat source, and allow the mixture to cool to room temperature. Then filter-off the insoluble solid product, and then dissolve it into 200 milliliters of hot acetonitrile. Once the solid product has dissolved into the acetonitrile, add in 10 grams of regular charcoal, and then stir the mixture for about 10 minutes; then filter-off the charcoal. After filtering-off the charcoal, and before the acetonitrile cools down, add 200 milliliters of ethyl acetate (more or less ethyl acetate may or may not be needed). During and after the addition of the ethyl acetate, the mixture will become turbid in nature. After the addition of the ethyl acetate, allow the entire mixture to stand overnight at room temperature. The following day, filter-off the precipitated product, and then vacuum dry or air-dry it; followed by storing in a desiccator filled with phosphorus pentoxide for 12 hours. The result will be about 6 grams of the desired product.

# Section VII

## METHODS OF DISSEMINATION AND USE

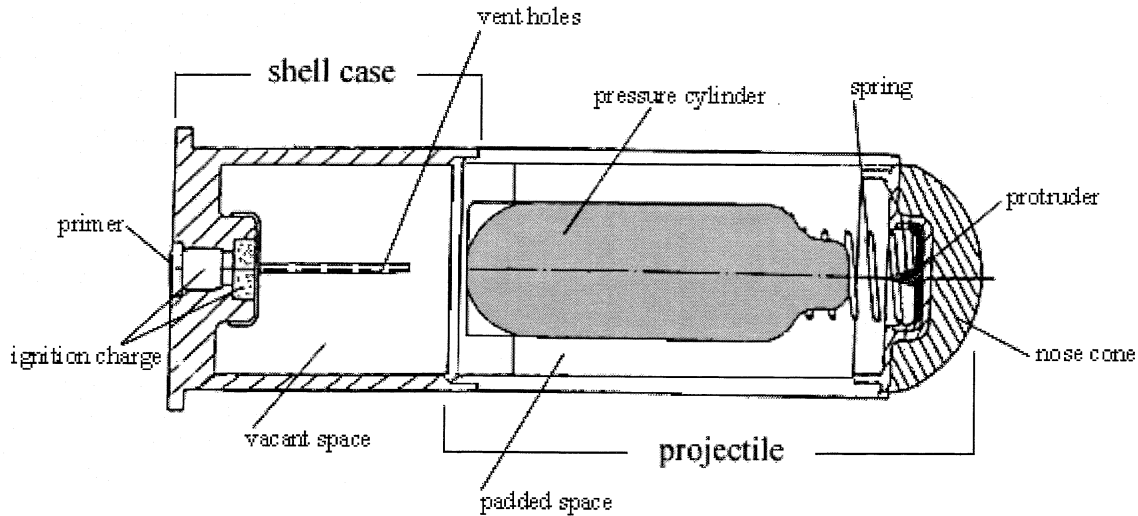
### Chapter 12: Dissemination techniques and munitions

#### I. Aerosol Techniques (pressure release systems)

Aerosol dissemination is very common for distributing chemical warfare agents on the battlefield. In fact, they are one most widely used and useful methods for disseminating agents. The method behind aerosols, other wise known as pressure release systems is quite easy. Think about a container of deodorant, hairspray, cooking spray, or fire extinguisher. Inside these containers there is a mixture of chemicals mixed in with a liquefied gas, called the propellant. The chemicals can be any desired substance or substances, and the propellant can be a number of compounds including propane, butane, isobutene, or isobutylene. Under normal conditions the propellant is normally a simple liquefied hydrocarbon gas, and the chemicals are hair styling compounds, skin treating compounds, food products, or chemicals designed to fight fires. When the container devices are actuated, either by depressing a button, pulling a trigger, or by bursting, the contents within these containers are rapidly dispersed outwards in a matter of moments.

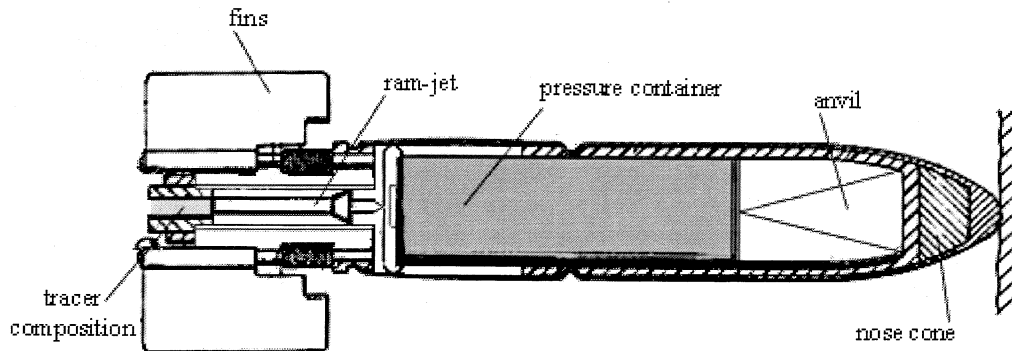
To understand how these pressurized containers disseminate the desired chemicals, one must understand the nature of aerosols, other wise known as "pressure release systems". Within an aerosol container, the propellant is under pressure. Most propellants are liquefied within the aerosol can—shake a can of hairspray—it makes the sound of liquid sloshing around. This liquid is the liquid propellant, which is the liquefied hydrocarbon gas. In essence, liquefied gases don't want to be liquids—they want to be gases, so when these liquefied gases are allowed to escape, they do so under tremendous force. When the liquefied gases are allowed to escape, they burst outwards forcing the ingredients within the container into the air—or onto your hair, skin, cooking pan, or grease fire. The chemicals, whether they are solids, liquids, or gases, when forced out of the container, form tiny dispersed particles. These tiny dispersed particles are called "micro fine particle dispersions". These micro fine particle dispersions are commonly formed due to the energy of the expanding propellant gas. The propellant gas, when it rapidly expands, forms a uniform dispersion with the chemical ingredients in the container—forming the micro fine particle dispersions. These dispersions contain the propellant gas, and any other ingredients within the container, and they can spread over large areas in a matter of seconds.

For chemical warfare aerosol munitions, the chemicals or ingredients are obviously not hair care products, skin ointments, cooking oils, or fire-fighting compounds—they are lethal or body-damaging chemicals capable of killing you, or seriously injuring you. The typical ingredients in a chemical warfare aerosol munition are: 1) 15 to 40% liquefied gas, 2) 1 to 2% stabilizer or thickener, and 3) 84 to 58% warfare agent or mixture. The liquefied gas can be propane, butane, isobutane, isobutylene, cyclopropane, cyclobutane, carbon dioxide, nitrous oxide, tetrafluoroethylene, or CFC's. The stabilizers or thickeners may vary, but can include any substance that does not react with the warfare agent or mixture, provides more viscosity to the agent, and provides a protection against decay or decomposition on prolonged storage. Such examples include saturated hydrocarbon oils, waxes, cyclic hydrocarbons such as benzene, toluene, and mesitylene, and various polymers ranging from PVC to Teflon—practically any polymer can be used as long it's somewhat soluble in the chemical agent or liquefied propellant gas. In some cases chemical agents, mostly vesicants and nerve agents, can be thickened by the same chemicals used to thicken gasoline or diesel fuel—aluminum or zinc salts of palmitic and naphthenic acids. Most chemical warfare agents can be stored for long periods of time, as long as water is not present—decay or decomposition of chemical warfare agents is usually the result of traces of water—this should be considered before preparing warfare munitions. When it comes to chemical warfare aerosol munitions, they all function and work the way as any other aerosol or pressure release systems, but with two main modes of actuation: 1) controlled release, and 2) un-controlled release. Controlled release is just like using a can of "hairspray". When we use the hairspray, we depress a small valve, which only lets out a small amount—small amount or not, a single burst from a can of hairspray sends it over a wide area—whether we tend to recognize it or not. Controlled release aerosols are quite common within riot control munitions of the grenade or low velocity projectile type—these devices emit a steady stream of agent once triggered. Controlled release aerosol systems can be used in most civilian and military scenarios, but is usually limited to dissemination of riot control agents, insecticides, herbicides, and rodenticides. Typical military operations using controlled release devices include, flushing out enemy personnel from bunkers, tunnels, or caves, dispersing crowds, or contaminating battlefields—either using lethal or non-lethal agents.

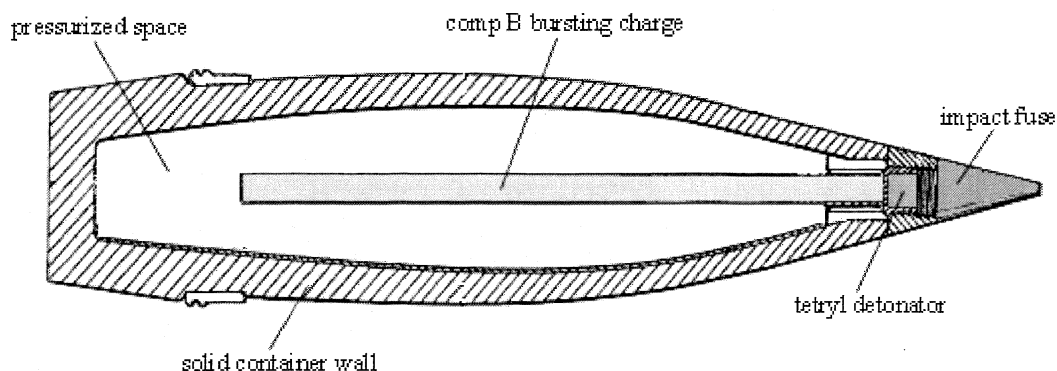


**Figure 051. Controlled release 40mm aerosol grenade.** This 40mm grenade is of typical design for controlled release aerosol munitions—when dealing with the function of the projectile; most controlled aerosol munitions of this type range from 40mm to 120mm, but can be as high as 160mm. The weapon is actuated when the projectile is fired from a launcher—upon activation of the primer, the ignition charge produces large volumes of gas, which fill the vacant space. The resulting pressure forces the projectile towards the target. Upon impact, the nose cone collapses inwards, causing the protruder to move inwards, and puncturing the pressure vessel. After the pressure vessel is punctured, the contents are evolved as a steady stream of vapor.

Un-controlled release aerosols are the most common aerosol devices used in warfare operations, and they are highly effective at delivering high concentrations of agent to specified areas in seconds. These aerosol devices emit their ingredients all at once, and this is accomplished by merely puncturing the pressurized aerosol container to form a large hole. In short, when an un-controlled release is desired, the aerosol container is ruptured, allowing the pressurized ingredients to escape and expand extremely rapidly—rather than slow and cumbersome. Munitions of this type include rockets, mortars, artillery shells, bombs, grenades, land mines, and any other type of weapon delivery system imaginable. If you want to understand better the nature of un-controlled release, think what would happen if we shot a cylinder of gas with a high-powered rifle—the container would explode like a bomb. Military weapons of the un-controlled type don't use violent techniques like rifle bullets to cause rupturing—they merely use ramjets, or protruders which puncture the container upon impact of the projectile, or actuation of the weapon. In some cases, small explosive charges can be used to rupture the pressurized container.



**Figure 052. Un-controlled aerosol warhead.** The warhead is fired from high velocity weapons such as rocket launchers, or gun barrels—20mm to 155mm. Note: Bazookas cannot be used. The projectile functions as follows: when the projectile is fired, from either weapon system, it travels towards the target at high velocity—must be at least 300 meters per second; a 9mm pistol bullet travels at about 950 meters per second. Upon impact, the forward physical force of the projectile striking the target and abruptly stopping, causes the ramjet to slam forward—rupturing the pressure container. The reverse anvil applies forward force. The contents of the pressure container are then suddenly released all at once.



**Figure 053. Explosive activated uncontrolled aerosol munition.** This illustration shows a 155mm artillery aerosol shell. The impact fuse triggers the tetryl detonator on impact of the shell, which in turn initiates the composition B bursting charge. The bursting charge rips apart the shell, and allows the pressurized contents to burst out all at once. These shells are extremely effective at delivering any known chemical warfare agent or mixture onto the battlefield. The composition B bursting charge only destroys about 10-15% of the agent upon detonation. In some cases highly flammable liquefied gases should not be used—due to possible ignition of the gas by the composition B bursting charge; although, in most cases, this is not a major concern.

The pressure vessels must be made of proper materials, and they must be able to withstand the necessary pressures. For example, a standard propane tank is designed to withstand the pressures applied to its walls—if the pressure is too great, the container will rupture prematurely. In most cases, the containers are made of steel, or some other high strength material. The ingredients are charged into the container, and the resulting container is then sealed—its like taking your barbecue propane tank in for re-filling, except in this case, the pressure vessels are filled with warfare agents, not propane.

Aerosol munitions can be used to disseminate any known chemical warfare agent; although, some chemical agents may chemically react with the steel or other material used for the container—this factor should always be discussed before charging the pressure vessel with the desired agent. For nerve agents, riot control agents, irritants, and experimental agents, standard steel containers can be used; for vesicants, high carbon steel doped with vanadium or titanium should be used. For blood agents especially hydrogen cyanide, specially designed steel containers should be used—consult shipping container info for hydrogen cyanide by checking with local chemical dealers—in some cases, normal steel may be used.

Aerosols are extremely effective at delivering any known chemical agent onto the battlefield; nevertheless, they may not always be the right choice of delivery. In some cases, different factors will rule out aerosols as delivery methods. High winds, windy weather, or heavy rain are unsatisfactory conditions for using aerosol weapons, unless for tactical reasons. High force winds tend to blow the chemical agents over too wide of areas—thereby diluting and dissipating the warfare agents. Because dissemination through aerosols produces very fine mists and vapors of the agent(s), high winds can easily blow these agents away—dissipating them to the point where their desired toxicities are decreased or eliminated.

Within enclosed environments such as bunkers, tunnels, and holes, dissemination of warfare agents through aerosols is extremely effective, and the most desired method of dissemination. During cold or warm, non-windy and/or non-heavy rain conditions, aerosol dissemination of warfare agents onto large open battlefields is very effective, and preferred as a major method of delivery in many cases.

There are drawbacks to aerosol munitions: 1) storage, and 2) premature munition rupturing. In many cases, storage of chemical warfare agents can be a major concern and problem. Numerous incidents of spills, and leaking munitions have been reported—although mostly from old, non-aerosol explosive actuated munitions. Because aerosol munitions are under constant pressure, they must be monitored and kept away from direct sunlight, and excessive heat. During combat, aerosol munitions must be stored in appropriate bunkers with adequate protection—the bunkers should be at least 3/4<sup>th</sup> underground, bunker roofs should be covered with at least 2 feet of heavy sandbags, and the bunker entrances must be out of direct range from in-coming shells or bombs—in any case, no method can fully protect from a massive direct hit from a penetrable shell or bomb. A bunker destroyed by an enemy shell or bomb could have disastrous consequences. This fact must always be a major concern, as artillery is the most likely weapon system to deliver the munitions—so munitions will be stored nearby. Other enemy munitions such as napalm could heat the munitions to the point where they burst from excessive pressures. In all cases, aerosol munitions must be protected from heat, fire, bombs, and any high velocity projectiles that could cause pre-mature rupturing.

## II. Smoke generating techniques (pyrotechnic devices)

Smoke generating munitions are primarily used to disseminate solid warfare agents. Because most chemical warfare agents are volatile or moderately volatile liquids, dissemination through smoke generating munitions is much less common. However, for

## Chapter 12: Dissemination techniques and munitions

chemical agents that are solids, dissemination through smoke generating techniques is quite common, and more practical than most other methods of dissemination. Smoke generating munitions are much cheaper and easier to produce than other munition delivery methods, and they are easier to maintain and much less prone to leaks, and spills. Smoke generating munitions also have much longer shelf lives than other munition delivery methods.

Smoke generating munitions are most common for the dissemination of riot control agents, vomiting agents, and irritants. They are also used to disseminate experimental warfare agents, and a select few nerve agents. Some nerve agents such as VX, V-sub x and IIVX can be disseminated with moderate success using smoke generating techniques. In essence, any chemical warfare agent can be disseminated with limited success using smoke generating munitions, but due to excessive heat produced upon ignition of the munitions, much of the liquid warfare agent is destroyed.

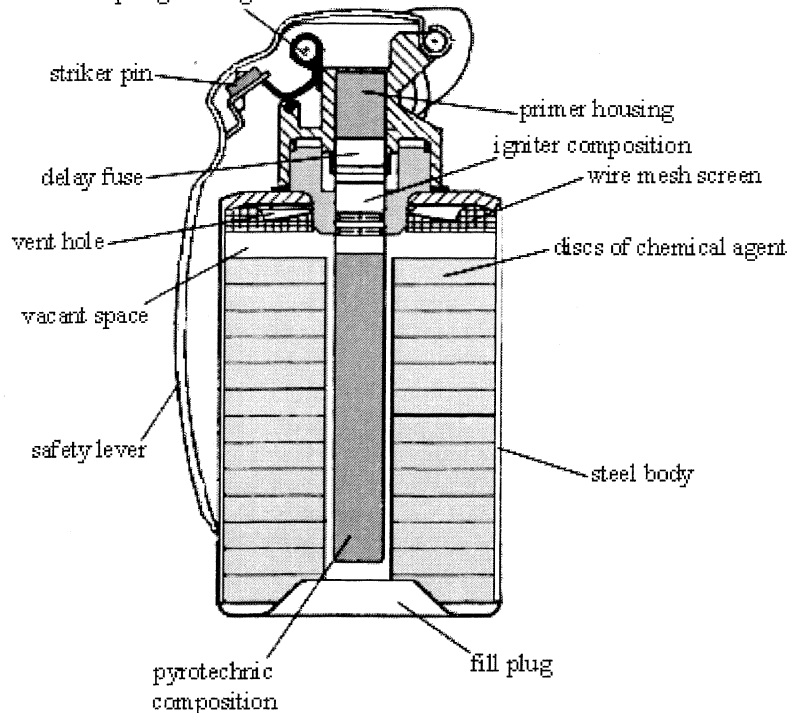
Smoke generating munitions work using the dynamics of volatilization with fast moving hot gas particles. When solids are subjected to heat and pressures under suitable conditions, they tend to volatilize or undergo a process similar to volatilization. Within smoke generating munitions there exists two simple components: 1) the fuel, or pyrotechnic mixture, and 2) the active chemical agent. The fuel is made up of a standard pyrotechnic mixture, similar to gunpowder, which burns when ignited. This burning pyrotechnic mixture produces heat and pressure, which leads to the solid chemical agent volatilization. The heat and pressure is not what directly causes the agent to volatilize, but rather generates high velocity forces, which literally shatter and blow the solid agent outwards. This outward thrust of solid agent produces micro-fine particles, which in turn, form a uniform mixture with the hot escaping gases produced by the burning fuel. The result is a uniform mixture of solid and gas, which expands like ordinary gases, and is called "smoke". Smoke in general, is a mixture of uniform solid particles mixed with hot expanding gases. Examples of other smoke generating processes include: 1) burning wood, 2) a burning cigarette, or 3) a typical colored smoke bomb firework.

As briefly mentioned earlier, any chemical warfare agent can theoretically be disseminated with limited success using smoke generating munitions; although because most chemical agents tend to decompose when excessively heated or exposed to fire, much of the agent would be destroyed during the burning of the fuel component. In most cases, smoke generating munitions are unsatisfactory for disseminating most chemical agents. A major factor besides heat and fire that supports this is the fact that most chemical agents are liquids, and would behave differently to the violent forces of the burning pyrotechnic fuel composition. Under these conditions, a liquid agent would more likely be "spit", or simply thrown out of the device like a shaken Champaign bottle rather than disseminated in a satisfactory form. This may work for contaminating a small area directly within the radius of the munition, but satisfactory dissemination is the ability to mix the agent with gas so as to give it the physical characteristics to expand over a wide area—a factor that would not be seen using smoke generating munitions with liquid agents.

Even during the process of smoke generation with solid chemical agents, as much as 25% of the desired chemical agent may be destroyed before it has time to escape the burning innards of the munition and form smoke. For most smoke generating riot control munitions, usually 15 to 20% of the chemical agent is destroyed during the deployment of the munition. These factors should always be considered before choosing to go with smoke generating munitions rather than aerosols.

So far the major drawbacks of smoke generating munitions has been discussed, but there are a few other drawbacks to this form of dissemination. 1) Smoke generating munitions produce much heat upon ignition. In some cases, sparks or burning embers from the device may shoot out or make their way out from the burning device into the surrounding environment. If this happens, brush fires and even forest fires may result. Several incidences of brush fires and forest fires have been caused by smoke generating munitions during military training exercises. These accidents were caused by regular smoke producing devices. 2) Smoke generating devices tend to take much longer to disseminate the agent than other delivery munitions, and the time for dissemination to complete depends on how long it takes for the fuel to complete its burn. For smaller munitions, this is not a concern, but large munitions such as shells and bombs would require significantly longer burning times to fully disseminate the agent. 3) High velocity projectiles, artillery shells, and bombs may become damaged or deformed upon impact with the target or ground. Damaged munitions may disrupt or defeat the proper functioning of the device.

Smoke generating munitions all function in the same manner, regardless of size or shape. The munitions in general contain a central core of pyrotechnic mixture, and an outer sphere of chemical agent. The inner core of pyrotechnic mixture is in the form of a solid rod, or cylindrical shaped rod composed of multiple circular discs of pyrotechnic mixture. The outer sphere of chemical agent is in the form of circular discs, like doughnuts. The central core of pyrotechnic mixture can be any known pyrotechnic composition composed of an oxidizer, combustible material, and binder. Satisfactory oxidizers are nitrates, chlorates, perchlorates, bromates, dichromates, or permanganates. Satisfactory combustible materials are charcoal, sulfur, flour, saw dust, cellulose, solid high molecular weight hydrocarbons, or powdered sugar—powdered metals should not be used. Binders can be a multitude of substances, as long they do not act as oxidizers. Binders are merely "glue" like materials that are used to "bind" the molecules of oxidizer with the molecules of combustible material to form a hardened body. The outer discs of chemical agent should consist of 80 to 90% chemical agent, and 20 to 10% binder. In this case, the binder should be a non-flammable mass.



**Figure 054.** A standard smoke generating munition—a hand grenade. The grenade works in the usual manner, and after the safety lever has been thrown clear and the primer actuated by the striker pin, a slow delay element of black powder burns down to an igniter composition. The igniter composition initiates the burn of the pyrotechnic composition. The burning pyrotechnic composition produces heat and pressure, which forces the chemical agent out through the vent holes. The wire mesh screens are used to decrease the chance for burning embers to escape.

### III. Explosive techniques (explosives munitions)

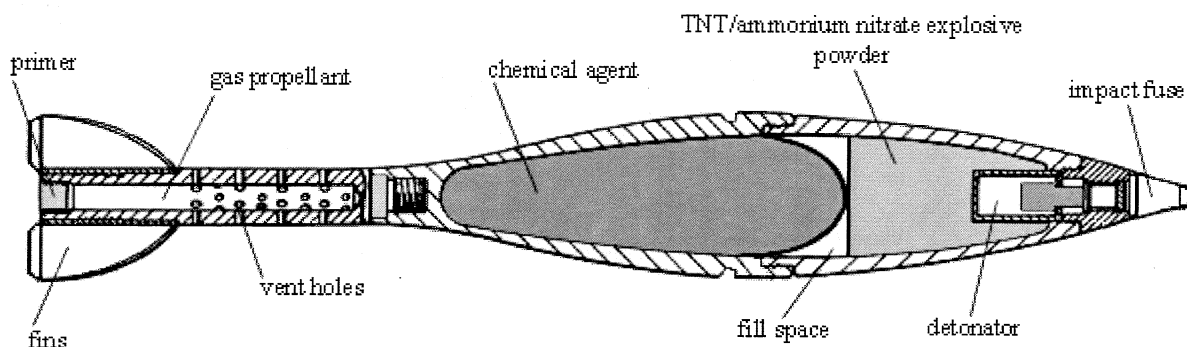
Dissemination of chemical warfare agents using explosive munitions is the most common method. Most chemical warfare munitions are projectiles, shells, bombs, or other devices, which detonate upon impact or activation, causing the agent or mixture to be thrown over a moderate area. Explosives munitions are quite easy to produce, and in essence, the most convenient source for chemical warfare delivery. Unlike aerosols, which require special apparatus and equipment for loading or unloading munitions, explosives oriented munitions are rapidly assembled and/or disassembled within minutes.

Even though explosive munitions are the most commonly used method for delivering chemical warfare agents onto the battlefield, they are not necessarily very effective. In many cases, much of the chemical agent is destroyed upon detonation, due to excessive heats produced from the explosion, and proper dissemination is often there for missed. Explosions can blow the warfare agents into the air and surrounding environment, but often dirt and other debris mixes with the agents, thereby disrupting the ability of the agents to thoroughly blend with the air and expand. However, explosive munitions can effectively distribute vesicants and nerve agents over specified areas, and contaminating said areas by contact—rather than through air contamination.

Explosives munitions cannot effectively be used to disseminate solid warfare agents. Attempts to disseminate solid warfare agents using explosive shells results in much decomposition of the solid agents, along with inadequate dissemination. Liquid agents show greater dissemination than solid warfare agents, and explosives munitions in general are primarily used to disseminate liquid vesicants and nerve agents.

Dissemination of chemical warfare agents is not all un-satisfactory when it comes to explosives munitions, and this is determined heavily on the amount of explosive used, and munition design. Obviously too much explosive would cause excessive decomposition of the liquid agent, but too little would do very poorly at dissemination. In essence, the explosive munition, the amount of explosive used, and the stability of the liquid nerve agent drastically determines the munitions ability to properly contaminate an area, and satisfactory dissemination of the agents. Munition design is considered an art form, but a few simple guidelines can be followed. For shells, and projectiles the following should be used: 1) The area of the shell, or projectile that contains the agent should be located to the rear of the munition; 2) The explosive used should be of low velocity (i.e., TNT and ammonium nitrate based), and should be located to the front of the munition, and in front of the chemical agent; 3) the explosive should not dip, or come in direct contact within the radius or vicinity of the liquid agent; 4) The amount of explosive used should only be about 20 to 30% of the total weight of the chemical agent, and the explosive body should not be casted—it should be in granular or powder form; and 5) the walls of the shell or projectile should not be excessively strong, meaning the shell or projectile should easily come apart upon detonation.

Regardless of shell design, on average at least 15 to 25% of the total chemical agent by weight is destroyed upon explosion of the shell, or projectile. Thickening agents can be mixed with the liquid chemical agent to provide added stability. Thickeners can range from waxes, oils, hydrocarbon solids, benzenes, and/or aluminum or zinc salts of palmitic or naphthenic acids.



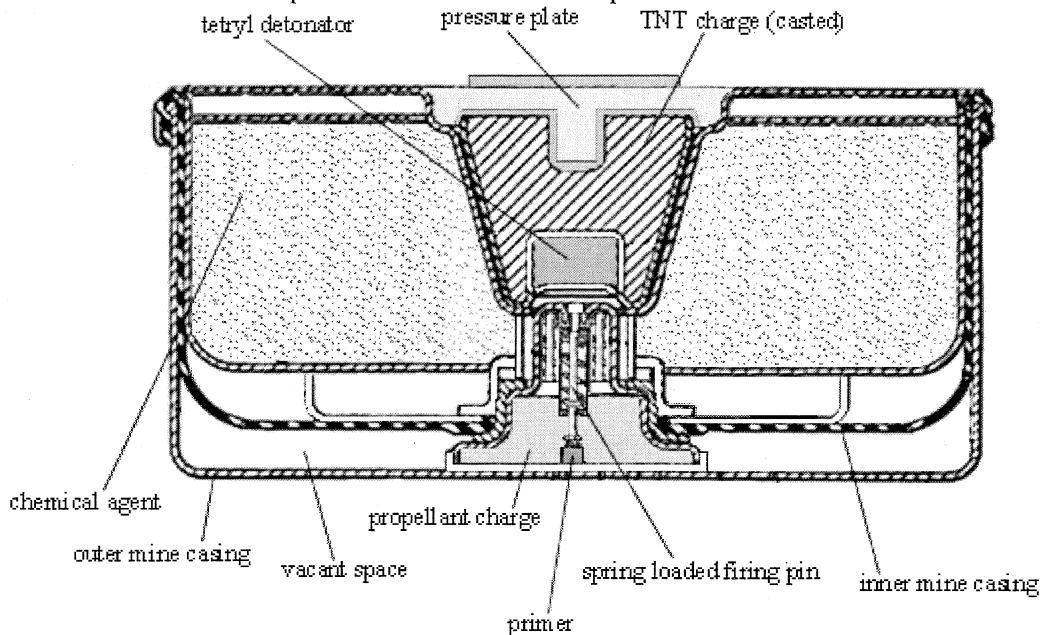
**Figure 055. A standard mortar shell. Mortars are fired when they are dropped into a mortar tube. The mortar tube contains a firing pin at the bottom of the tube, and when the mortar shell slides down the tube, it strikes the firing pin, which initiates the gas propellant mixture. The gas propellant mixture produces tremendous pressure which forces the shell down-range. Upon impact of the shell, the detonator is activated, which initiates the TNT/ammonium nitrate explosive mixture. The detonation of this explosive rips apart the shell, and throws the liquid chemical agent into the environment, contaminating a small area.**

Bombs and other large explosive munitions should be designed by the following: 1) The inner core of the bomb is where the explosive goes. As with shells and projectiles, the explosive used should be TNT/ammonium nitrate based, and should be in granular or powder form—about 20 to 30% of the total weight of the chemical agent; 2) the outer space surrounding the inner core of explosive is where the chemical agent goes. For large bombs, the liquid chemical agent should be thickened using petroleum oils, or aluminum or zinc salts of palmitic or naphthenic acids; 3) The walls of the bomb should not be excessively thick, meaning the bomb should easily break apart upon detonation; and 4) The fuse of the bomb should be designed so it detonates the bomb above the target, not on impact. The size of the bomb dictates the altitude—for bombs up to 500 pounds (total weight), the bomb should be detonated at 25 feet above the target; bombs up to 1000 pounds should be detonated at 40 feet above the target; and bombs up to 2000 pounds should be detonated at 60 feet above the target.

Explosive shells, projectiles, and bombs are not the only delivery methods for explosive oriented warfare munitions. Most often left behind closed doors, are specialty designed explosive chemical warfare munitions. The most common of these types of munitions are chemical land mines. Ordinary land mines are already under much debate and scrutiny, but chemical land mines break the mold of controversy. Believe it or not, the US and other western nations have stock piled chemical land mines, and have extensive battle plans for the use there of. Chemical land mines are one the most secret, and covert methods of distributing chemical warfare agents, and contaminating environments. Many chemical land mines are air-deliverable, meaning they are dropped from “cluster bomb” type weapons—where they get self-buried in the ground over short periods of time. Despite the many weapon systems available for the distribution and dissemination of chemical agents, chemical land mines are actually quite common, and remain a preferred method for tactical operations.

Specialty munitions like chemical mines should be designed as follows: 1) The mines outer casing should be composed of all weather, chemical resistant metal alloy, which is strong; 2) The inner mine casing should be composed of mild metal alloy, and it should be readily breakable upon mind detonation; 3) The explosive charge should be composed of casted TNT, Picric acid, or any medium velocity explosive; and 4) The mines should be bounding type mines, which are highly effective at disseminating the chemical agent—as they air burst upon activation. The bounding mines can be pressure activated, trip wire activated, tilt rod activated, or man fired. Preferably, the bounding mines should be supplied with not only a pressure plate, but one or more tilt rods, and one or more trip wires—preferably 6 to 9 trip wires forming a plurality that extends like a spider web from the central mine. Multiple activated bounding land minds are the best for maximizing potential activation by enemy personnel.





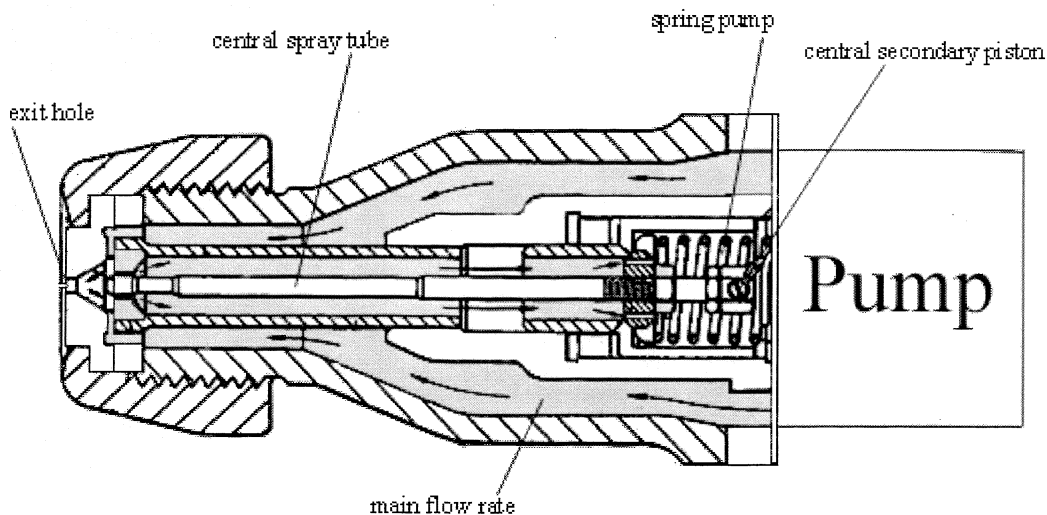
**Figure 056. A bounding land mine.** The mine is activated when someone steps on the pressure plate. Pressure from a man's foot depresses the pressure plate, which releases a spring-loaded firing pin. The firing pin slams down, striking a primer, which activates the propellant charge. The propellant charge produces large volumes of gas which forces the inner mine, which is the actual mine, up into the air where it detonates. A quick burning pyrotechnic fuse, not shown, is ignited simultaneously as the propellant charge. This quick burning fuse burns to the tetryl detonator within a matter of seconds. By the time the quick fuse burns to the tetryl detonator, the mine has reached an altitude of about 5 meters. The detonation of the tetryl booster, initiates the casted TNT charge. The detonation of the TNT throws the chemical agent in all directions, whereby a small area is contaminated.

#### IV. Special techniques (atomizers, humidifiers, and foggers)

Atomizers, humidifiers, and foggers are unique devices for the delivery of chemical warfare agents. In many cases, they are quite common, but are only used during special situations. Under most conditions, chemical warfare agents are delivered and disseminated using aerosols or explosive munitions. Aerosols and explosives munitions are primarily used to delivery and disseminate warfare agents directly or indirectly to the desired target areas from safe distances. Atomizers, humidifiers, and foggers however, are used in cases where warfare agents need to be disseminated on-site, and in various quantities. To do this, atomizers, humidifiers, and foggers are specially designed machines, which disseminate the agents on-site utilizing various techniques of volatization and humidification. The techniques of volatization and humidification utilize air as a major component to proper function, and resemble the natural processes of mists, humidity, and fog. Most atomizers, humidifiers, and foggers used in chemical warfare are mounted on trucks, tanks, or other vehicles.

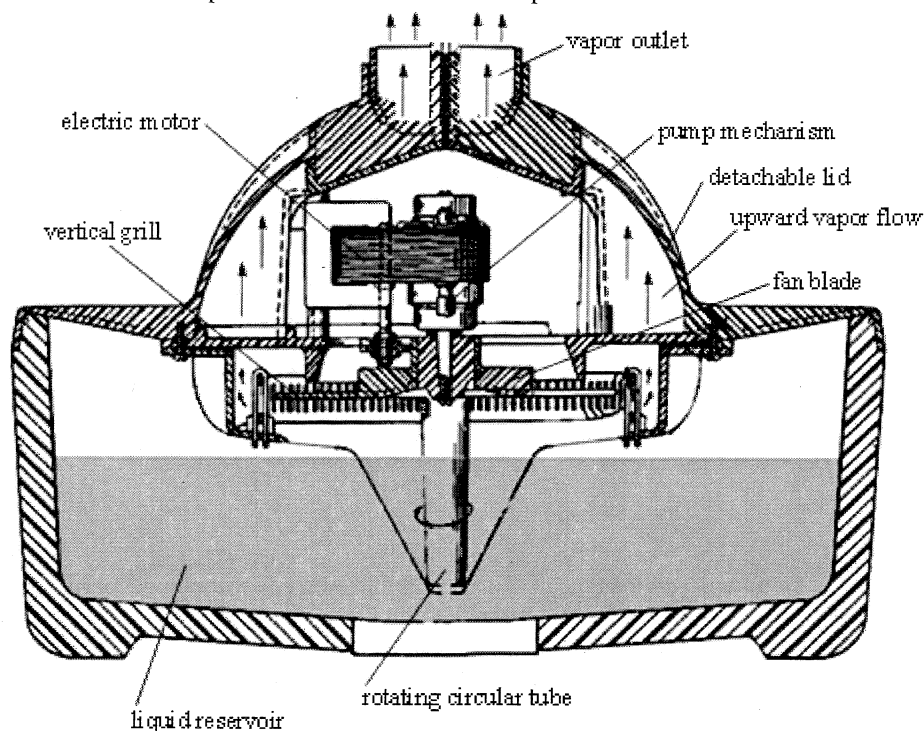
Atomizers, humidifiers, and foggers used for the dissemination of chemical warfare agents, work in similar manners as for commercial or industrial devices. Such examples include fuel injection systems (atomizers), personnel health care humidifiers, and agricultural pesticide dissemination techniques utilizing fog-making machines. Other examples include: industrial chemical applications, spraying operations for personnel, commercial, and/or agricultural means, and fire extinguishing systems. Atomizers are special, yet simple devices, which cause liquids to form fine mists or sprays. These mists or sprays easily mix with air and expand over wide areas. The exact mechanical nature of atomizers is similar, but can vary widely. The main focus of atomizers is to produce fine mists or sprays of any desired liquid. To do this, most atomizers use piston type mechanical functions to produce suction, so as to bring in the fluid from a central reservoir, and then force said fluid through a specially designed nozzle, where by it is "atomized" into a fine mist or spray. In general, an atomizer functions in a manner resembling a standard household spray bottle, such as a "windex" or "4 or 9" bottle. In this case, the force action of the sprayers finger on the trigger mechanism of the bottle, forces a piston into movement. This movement creates a suction, which draws in the liquid from the reservoir (the bottle), and discharges it through a simple, yet specially designed nozzle—this action creates a fine mist or spray. Most atomizers used in chemical warfare use gas operated or electrically operated pistons to create suction and discharge of the liquid. Atomizers can only be used to disseminate liquid agents, or solutions of solid agents dissolved in suitable solvents. Any solid warfare agent dissolved in an appropriate solvent can be used with atomizers.





**Figure 057. Close up view of a standard atomizer head. The pump and other features have been omitted from the illustration. The pump can be of many different styles and/or function, but they are normally electrically actuated pumps. The central secondary piston is connected to the main piston, and it is responsible for a secondary pump action—sending the fluid down the central spray tube under erratic pressures. The erratic pressures coincide with the suction created with the pump, and this activity is what causes the fluid to be ejected from the exit hole at high velocity. The high velocity ejection creates a very fine mist or spray—depending on spray pattern chosen for the exit hole. This particular design would produce a very fine mist upon actuation.**

Humidifiers are devices that produce very fine vapors composed of liquid and air—similar to ordinary moisture in the air. Essentially, humidifiers atomize the liquid component into a fine mist or spray, but instead of ejecting said atomized liquid as is, the fine mist or spray is mixed thoroughly with air on-site, so as to produce a uniform mixture of liquid and air particles. This fine uniform mixture, other wise known as a “humidified” vapor, is then ejected into the atmosphere. In short, the atomized chemical agent is produced using a different approach then for ordinary atomizers. The chemical agent or liquid is drawn up into the housing of the device using a centrifugal force pump. This centrifugal pump pulls the liquid agent up and onto a fan blade, which disperses the liquid onto a vertical grill. This action produces a high surface area upon the liquid. The high surface area of the liquid that is created produces a fine mist, which then mixes with a current of air to form a “humidified” vapor. The vapor then escapes through the top vent port of the device. In essence, these humidifiers are identical in nature to standard store bought water humidifiers. Humidifiers can only be used to effectively disseminate some liquid agents. In most cases, the more non-volatile liquid agents will not disseminate properly using humidifiers. Dissemination of solutions containing dissolved solid agents in appropriate solvent(s) is impossible because only the liquid solvent part is removed, which would leave the solid agent behind.

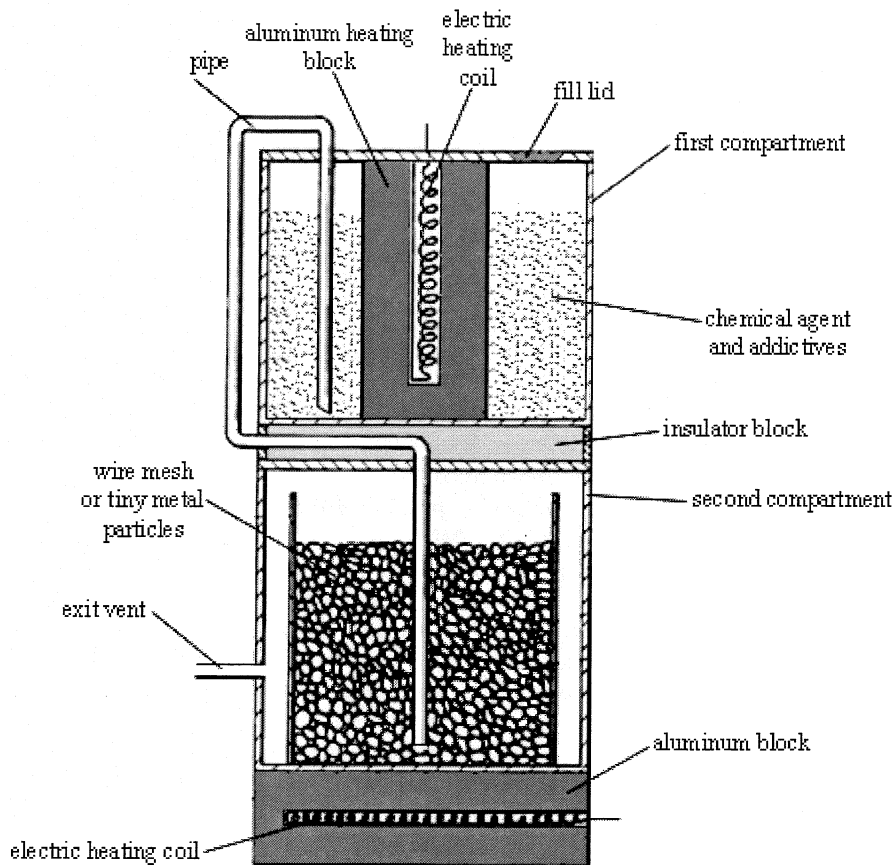


**Figure 058.** A standard humidifier—similar, but much smaller than a vehicle mounted device. The electric motor functions in two parts: 1) moving the centrifugal pump, and turning the fan blades. The centrifugal pump forces liquid up into the housing where by it makes contact with the fan blade. The force of the fan blade throws the liquid against a vertical grill thereby forcing the liquid into a greater surface area. The rotational action of the fan blade then proceeds to spray the high surfaced liquid into fine mists. Suction created by the electric motor draws air into the housing, whereby it mixes with the fine mists of liquid. The mixing of the fine mists of liquid with the air, produces a uniform vapor, which exits the device at the upper outlet vents. This vapor flow is directed upwards by the simple rotational direction of the fan blades. For information on the general function of humidifiers (not for chemical warfare dissemination), see serial number 187,695 April 16<sup>th</sup>, 1962 by Paal Myklebust, Baraboo, assigned to Hanksraft Company,

Foggers are used to generate fine dispersions of tiny uniform particles of chemical agent resembling that of natural fog or smoke. The design of foggers can vary widely, but they all produce uniform dispersions of particles by utilizing volatilization and pressure. A standard fogger is composed of two main compartments. Both compartments are connected using a pipe, and both compartments are heated using electrical coils. The first compartment contains the active chemical agent and additives. The second compartment contains wire mesh screen, or small fragments of metal. The additives used in the first compartment are determined by what chemical agent or mixture of agents is to be disseminated. When heat is applied to the first compartment, the liquid mixture begins to volatilize producing pressure. This pressure forces the liquid mixture into the pipe, which connects both compartments. As this liquid reaches the second compartment, its surface area is changed drastically as it makes contact with the wire mesh screen or tiny metal particles. The heat of the liquid mixture making contact with the wire mesh screen or small metal fragments causes the liquid mixture to expand, and untimely vaporize to the point where additional pressure forces it out an exit vent. The second compartment is heated as well, so as to continue pressurization of the liquid mixture. As the vaporized liquid mixture is ejected from the exit vent, its contact with the outside air, which is much cooler, causes the vaporized liquid mixture to suddenly cool and form a fine dispersion of tiny particles of chemical agent and air. This fine dispersion expands and occupies an area like a natural fog. Sometimes this synthetic fog will linger in areas for periods of time ranging from 1 hour to 12 hours depending on the weather. In most cases, the synthetic fog will condense on the surface of plants, leaves, trees, grass, wood, and many other objects within hours of release.

Not all chemical agents can be satisfactorily disseminated using foggers. Decomposition due to heat and pressure may result from certain agents. Chemical agents that can be satisfactorily disseminated are solid agents that are soluble in high boiling hydrocarbon liquids or glycols, and relatively moderate to non-volatile liquid agents. Such agents include, VX, VX-II, V-sub x, soman, thiosoman, and cyclosarin. The additives include a series of compounds of the glycol family or high boiling hydrocarbon liquids. For VX, VXII, and V-sub x, propylene glycol, ethylene glycol, or high boiling hydrocarbon liquids should be used as the additive. Heavy viscous hydrocarbon oils, which can be selected from a huge family of compounds, can also be used. High boiling hydrocarbon liquids should be used with soman, thiosoman, and cyclosarin. As previously stated, solid warfare agents cannot be disseminated properly if they do not dissolve in the appropriate glycol or hydrocarbon liquid—in other words, solid warfare agents need to be dissolved into the glycols or hydrocarbon liquids prior to use.

Once the appropriate additive has been chosen, it should be added to the first compartment, along with the desired chemical agent—if using a solid warfare agent, it needs to be dissolved in the additive prior to loading into the first compartment. Once the first compartment has been loaded, the device is sealed, and electrical power supplied to the heating coils. Once the pressure builds up in the first compartment, dissemination of the liquid mixture begins rapidly, and large amounts of “fog” are produced. It does not take long for the first compartment to be depleted of liquid mixture; as a result, foggers in most cases are rather large devices mounted on trucks, tanks, or other vehicles, and they are connected to central reservoirs so as to reload the first compartment for additional fog making.



**Figure 059.** A schematic of a standard fogger. The temperature of the first compartment should be around 115 to 125 Celsius. The temperature for the second compartment usually ranges from 220 to 320 Celsius. The wire mesh or small metal fragments should be made of inert metal—usually steel, nickel, or titanium. Note: The design and function of foggers can vary, and there are numerous variations and styles that can be made to this general design. For more info on fog makers (not for chemical warfare distribution), see Application number: 648, 189, PCT filed: November 24<sup>th</sup>, 1994 Alfona Vandoninck of Deurne, Belgium. Assigned by Jaico, of Oplabeck, Belgium

## References

- “Cyanophosphonoamides and method for preparation”  
Application number: 09/450,309, November 29<sup>th</sup>, 1999  
Patrick J. Lennon, of Webster groves MO, and Serge G. Vulfson, of Chesterfield, MO. Assigned to Monsanto Company.
- “Non-lethal Ammunition with Incapacitating effect”  
Application number: 09/202,848, June 21<sup>st</sup>, 1996  
Genevieve Leichter, of Pibrac France, Michel Castarede, of Saint-Orens, France, and Bruno Gromek, of Muret, France. Assigned by Etienne Lacroix Tous Artifices S.A.
- “Rapid-release smoke hand grenade”  
Application number: 768,898, December 17<sup>th</sup>, 1996  
Peter Rayer, of Neuenburg, Germany, Norbert Wardecki, of Heuweiler, Germany, and Karl Raupp, of Neuenburg, Germany. Assigned by Buck Werke GmbH & Co.
- “Device for generating a fog”  
Application number: 648, 189, PCT filed: November 24<sup>th</sup>, 1994  
Alfona Vandoninck of Deurne, Belgium. Assigned by Jaico, of Opplabeck, Belgium
- “1,1,1-Trichloro-2-nitroethane production”  
Application number: 908,725, July 6<sup>th</sup>, 1992  
Isao Aoki, of Daiwahigashi, Japan, Takanori Tabuchi, of Osaka, Japan, and Isao Minamida, of Hyoge, Japan. Assigned by Takeda Chemical Industries, Ltd.
- “Mortar Grenade”  
Application number: 864,008, May 16<sup>th</sup>, 1986  
Jose G. Garcia, of Vizcaya, Spain. Assigned by Esperanza y Cia, S.A., Spain
- “Production of dichloroformoxime”  
Application number: 603,847, April 25<sup>th</sup>, 1984  
William R. Hydro, of Bel Air, MD
- “Process for preparing dicyanogen”  
Application number: 518,899, August 1<sup>st</sup>, 1983  
Rudolf Fauss, of Cologne, Germany, Karl Heinz Linker, of Leverkusen, Germany, and Kurt Findeisen, of Odenthal, Germany
- “Aerosol Projectile for Lachrymating Material”  
Application number: 704,788, July 13<sup>th</sup>, 1976  
Guido John Gaggini, of Cowansville PA, and Eugene Lawrence Gould, of Kittanning, PA  
Assigned by Federal laboratories, Inc.
- “Atomizers”  
Application number: 553,657, February 27<sup>th</sup>, 1975  
Terence Tyler, Allestree, England. Assigned by Clarke Champman Limited.
- “Process for the manufacture of cyanogen”  
Application number: 583,516, June 4<sup>th</sup>, 1975  
Wilhelm Riemenschneider, of Frankfurt am Main, Germany, and Peter Wegener, of Schneidhain, Taunus, Germany. Assigned by Hoechst Aktiengesellschaft
- “Synthesis of Ortho-chlorobenzalmalononitrile”  
Application number: 496,571, August 12<sup>th</sup>, 1974  
John S. Knapp, of Pittsburgh, PA. Assigned by Federal Laboratories, Inc.
- “Process for the manufacture of orthochlorobenzalmalononitrile”  
Application number: 8,388, February 3<sup>rd</sup>, 1970  
Walter L. Berry, Jr., of Yardley, PA, Dan P. Nisonger, and Preston S. Craig, both of St. Simons Island, GA.
- “Novel Diimine compounds”  
Serial number: 32,384, April 27<sup>th</sup>, 1970  
Jonathan M. Kliegman and Robert K. Barnes, both of Charleston, West Virginia. Assigned by Union Carbide Corporation.
- “Production of O-chlorobenzalmalononitrile”  
Serial number: 765,673, October 7<sup>th</sup>, 1968  
Jacob Rosin, of Maplewood, NJ. Assigned by Chris-Craft Industries, Inc.
- “Chemical Agents”  
Application number: 624,649, March 7<sup>th</sup>, 1967  
Harold Z. Sommer, of Havre de Grace, MD. Assigned by The United States Army
- “Chemical agents”  
Application number: 643,302, May 29<sup>th</sup>, 1967

## References

- Harold Z. Sommer, of Havre de Grace, MD, and Omer O. Owens, of Abingdon, MD. Assigned by The United States Army.  
“Explosive Projector”  
Serial number: 454,470, May 10<sup>th</sup>, 1965
- Clayton J. Schneider, Jr., of Amhurst, NY. Assigned by Cornell Aeronautical Laboratory, Inc.  
“Preparation of phosphorus halides”  
Serial number: 515,754, December 22<sup>nd</sup>, 1965
- Joseph W. Baker, of Kirkwood MO, and Raymond E. Stenseth, of St. Louise MO. Assigned to Monsanto Company.  
“O.O-Neopentylene-N-Diethylphosphoroamidothioate”  
Serial number: 274,336, April 19<sup>th</sup>, 1963
- Marcel A. Gradsten, of Demarest, NJ. Assigned to Mesne assignments, to Tenneco Chemicals, Inc.  
“Preparation of Bromochloropicrins”  
Serial number: 298,398, July 29<sup>th</sup>, 1963
- George A. Burk, of Bay city Michigan, and Ralph A. Davis, of Midland, Michigan. Assigned by The Dow Chemical Company.  
“Anti-pillaring smoke shell”  
Serial number: 182,159, March 22<sup>nd</sup>, 1962
- Henry Rosenthal, of Washington, DC  
“Humidifier”  
Serial number 187,695 April 16<sup>th</sup>, 1962
- Paal Myklebust, of Baraboo Wisconsin. Assigned by Hanksraft Company  
“Process for synthesizing chloropicrin”  
Serial number: 79,994, January 3<sup>rd</sup>, 1961
- John M. Wilhelm, of Culver City, CA  
“New process for manufacturing chloronitro derivatives of methane”  
Serial number: 1,436, January 11<sup>th</sup>, 1960
- Pierre Baumgartner, of Asnieres, France. Assigned by to Institut Francais du Petrole, des Carburants et Lubrifiants, Paris, France  
“Preparation of Alkylphosphonothiolates”  
Application number: 62, 305, October 12<sup>th</sup>, 1960
- Sigmund R. Eckhaus, of Baltimore MD, Jefferson C. Davis, Jr., of Austin, TX, and Bernard M. Zeffert, Baltimore, MD. Assigned by The United States army.  
“Vinylphenylmetal compounds”  
Serial number: 799,456, March 15<sup>th</sup>, 1959
- Hugh E. Ramsden, of Scotch Plains, NJ. Assigned by Mesne Assignments, to M & T Chemicals, Inc.  
“Method for the production of 1-Dimethylamino-2-chloroalkyl hydrochlorides”  
Serial number: 806,452, April 15<sup>th</sup>, 1959
- Robert Velgos, of St. Louise, Michigan. Assigned by Michigan Chemical Corporation.  
“Production of chloralkyl ammonium chlorides”  
Serial-number: 838,387, September, 8<sup>th</sup>, 1959
- Hans Soenksen, Hans Stanger, Albert Palm, and Joseph Schmidt, all from Ludwigshafen, Germany. Assigned by Badische Aniline & Soda-Fabrik Aktiengesellschaft, Ludwigshafen.  
“Purification of Isopropyl methylphosphonofluoridate—sarin”  
Serial number: 738,241, May 27<sup>th</sup>, 1958
- Leland K. Beach, of Middlesex, England. Assigned to The United Sates Army.  
“Heterocyclic Phosphorus containing monofluorides and process for making same”  
Serial number: 651,834, April 10<sup>th</sup>, 1957
- William M. Lanham, of Charleston West Virginia. Assigned to Union Carbide Corporation.  
“Production of thioether glycols”  
Serial number: 662,337, May 29<sup>th</sup>, 1957
- Christian Wegner, of Leverkusen, Germany, Hans Holtschmidt, of Kolnstammheim Germany, and Kurt Hess, of Leverkusen, Germany. Assigned by Mesne assignments to Mobay Chemical Company.  
“Vinylarsenic and Antimony compounds and methods of preparation therefore”  
Serial number: 671,372, July 12<sup>th</sup>, 1957
- Hugh E. Ramsden, and Scotch Plains, NJ. Assigned by Metal & Thermit Corporation.  
“Method of manufacture of  $RP(O)Cl_2$  from  $RP(O)(OR)_2$  and  $SOCl_2$ ”

## References

- Serial number: 504,127, April 26<sup>th</sup>, 1955  
Thomas P. Dawson, of Bel Air, MD, and Jack W. Armstrong, of Concord, CA. Assigned to The United States Army.  
"Preparation of mono and diarylarsines"  
Serial number: 517,369, June 22<sup>nd</sup>, 1955  
Louis Schmerling, of Riverside, ILL. Assigned by Universal Oil Products Company.  
"Manufacture of phosphorus amide"  
Serial number: 281,886, April 11<sup>th</sup>, 1952  
George A. Saul and Kenneth L. Godfrey, both of St. Albans, West Virginia. Assigned by Monsanto Chemical Company.  
"Process for preparing alkyldihaloarsine"  
Serial number: 291,053, May 15<sup>th</sup>, 1952  
Morris S. Kharasch, of Chicago, IL, and Sidney Weinhouse, of Chester, PA. Assigned to The United States Secretary of War.  
"Method of Producing Alkyl phosphonyl dihalides"  
Serial number: 292,390, June 7<sup>th</sup>, 1952  
John P. Clay, of Dugway Proving Grounds, Tooele, Utah. Assigned to The Board of Higher of Education.  
"Process for preparing alkyldihalostibine"  
Serial number: 291,054, October 21<sup>st</sup>, 1952  
Morris S. Kharasch, of Chicago, ILL., and Sidney Weinhouse, of Chester, PA. Assigned by The united Sates Secretary of war.  
"Process for the preparation of bis-isopropyl-amino-fluoro-phosphine oxide"  
Serial number: 225,264, May 8<sup>th</sup>, 1951  
Gilbert Spencer Hartley, of Fulbourn England, Denis William Pound, of Harston England, Dennis Frederick Heath, of Cambrdeg England, and Joseph Mills Hulme, of Saffron Walden, England. Assigned to Pest Control Limited.  
"Bis-chlorobutenyl sulfides"  
Serial number: 140,749, January 26<sup>th</sup>, 1950  
Warren D. Niederhauser, of Philadelphia, PA. Assigned by Rohm A Hass Company.  
"1-Bromo-4-N-Alkylamino) hexanes and process of making them"  
Serial number: 660,415, April 8<sup>th</sup>, 1946  
Robert C. Elderfiled, of Hastings on Hudson, and James D. Head, of New York, NY. Assigned by The United States of the office of scientific research and development.  
"Process for the production of fluorophosphonic acid compounds"  
Serial number: 10,938, August 8<sup>th</sup>, 1946  
Hamilton McComb and Bernard Charles Saunders, of the University of Cambridge, and Robert Heap, of Cheam England  
"Process for making bromine cyanide"  
Serial number: 697,956, September 19<sup>th</sup>, 1946  
Raymond H. Hartigan, of Pittsburgh, PA. Assigned by Koppers Company, Inc.  
"Halogenated Compounds and Process for making same"  
Serial number: 520,100, January 28<sup>th</sup>, 1944  
Edgar E. Hardy, of Anniston, Alabama, and Gennady M. Kosolapoff, of Dayton, OH. Assigned to Monsanto Chemical Company.  
"Method of preparing ethyl dichlorophosphine"  
Serial number: 523,364, February 21<sup>st</sup>, 1944  
Morris S. Kharasch, of Chicago ILL., and Sidney Weinhouse, of Chester PA. Assigned by The United States Secretary of War.  
"Preparation of Lewisite"  
Serial number: 536,848, May 22<sup>nd</sup>, 1944  
Paul D. Bartlett, of Weston MA, Hyp Joseph Dauben, Jr., of Cambridge, MA, and Leonard J. Rosen, of Cumberland, MD.  
"Process for making organic phosphorus halides"  
Serial number: 544,836, July 13<sup>th</sup>, 1944  
Cheves Walling, of Montclair, NJ. Assigned by E.I. du Pont de Nemours  
"Method of preparing chloroalkylamine hydrochlorides"  
Serial number: 556,667, September 30<sup>th</sup>, 1944  
Albert F. Hardman, of Akron, OH. Assigned by Wingfoot Corporation, Akron, OH.  
"Anhydrous Monofluorophosphoric acid and method of production"

## References

- Serial number: 478,838, March 11<sup>th</sup>, 1943  
Willy Lange and Ralph Livingston, of Cincinnati, OH. Assigned by Direct and Mesne Assignments, to Ozark Chemical Company.  
"Reaction and products there from"
- Serial number: 429,833, February 6<sup>th</sup>, 1942  
William A. Hoffman, of Wilmington, Delaware. Assigned by E.I. du Pont de Nemours & Company.  
"Bromination"
- Serial number: 439,103, April 15<sup>th</sup>, 1942  
John Ross, of Ramsey, NJ. Assigned by Colgate-Palmolive-Peet Company.  
"Chlorination of nitromethane"
- Serial number: 189,763, February 10<sup>th</sup>, 1938  
Byron M. Vanderbilt, of Terre Haute, Indiana. Assigned by Commercial Solvents Corporation.  
"Process of making bis(beta-chloroethyl) sulfide"
- Serial number: 149,238, June 19<sup>th</sup>, 1937  
George E. Miller, of Edgewood Arsenal, Edgar M. Faber, of Baltimore MD, and Arthur M. Reeves, of Havre de Grace, MD. Assigned to The United States Secretary of War.  
"Process of producing halogen alkyl amines or their salts"
- Serial number: 65,812, February 26<sup>th</sup>, 1936  
Heinrich Ulrich and Ernst Ploetz, both of Ludwigshafen-on-the-rhine, Germany, and Max Bogemann, of Colognemuhlheim, Germany. Assigned by I.G. Farbenindustrie Aktiengesellschaft, Frankfurt-on-the-Main, Germany.  
"Halogenation of diketene"
- Serial number: 87,669  
Albert B. Boese Jr., of Pittsburgh, PA. Assigned by Carbide and Carbon Chemicals Corporation.  
"Dialkylaminophosphorus fluorides and a process for their preparation"
- Serial number: 88,263, June 30<sup>th</sup>, 1936  
Gerhard Schrader, and Otto Bayer, of Leverkusen I.G. Werk, Germany. Assigned to Winthrop Chemical Company.  
"Manufacture of Halogen Alkylamines"
- Serial number: 57,511, January 4<sup>th</sup>, 1936  
Walter Maler, of Jessnitz, Germany. Assigned by I.G. Farbenindustrie Aktiengesellschaft, Frankfurt-on-the-Main, Germany.  
"Chlorinated Trialkyl Amines and Method of producing"
- Serial number: 714,095, March 5<sup>th</sup>, 1934  
Kyle Ward, Jr., of Wilmington, Delaware. Assigned by Hercules Powder Company.  
"Process of producing chloropicrin"
- Serial number: 619,354, June 25<sup>th</sup>, 1932  
William D. Ramage, of Pittsburgh, CA. Assigned by Great Western Electro-Chemical Company.  
"Process of making cyanogen chlorides"
- Serial number: 163,565, January 25<sup>th</sup>, 1927  
Johann Paul Schmittnagel, of Basel Switzerland. Assigned by National Aniline & Chemical Company, Inc.  
"Production of cyanogen chloride"
- Serial number: 175,419, March 14<sup>th</sup>, 1927  
Paul Dieterle, of Buffalo, NY. Assigned by National Aniline & Chemical company, Inc.  
"Method of making cyanogen bromide"
- Serial number: 30,138, September 15<sup>th</sup>, 1900  
Carl Goepner and Wilhelm Witter, of Hamburg, Germany
- H. Dupont Durst and George W. Gokel: *Experimental Organic Chemistry*, 2<sup>nd</sup> edition., McGraw-Hill, Inc. United States of America, 1987
- Gershon J. Shugar and Jack T. Ballinger: *Chemical Technicians Ready Reference Handbook*, 4<sup>th</sup> edition., McGraw-Hill, Inc. United States of America, 1996
- Merck & Co., Inc.: *The Merck Index*, 12<sup>th</sup> edition., Whitehouse Station, NJ, 1996
- Donald L. Pavia, Gary M. Lampman, and George S. Kriz: *Organic chemistry I*, 1999 revision., United States of America, 1999
- Jerry March: *Advanced Organic Chemistry*, 4<sup>th</sup> edition., John Wiley & Sons. United States of America, 1992

Property	Sulphur mustard	Nitrogen mustard	Lewisite	Mustard/lewisite mix	Phosgene oxime
Appearance	Colourless to light yellow liquid, giving off a colourless vapour	Dark coloured liquid giving off a colourless vapour	Dark oily liquid giving off a colourless vapour	Dark oily liquid giving off a colourless vapour	White solid or yellow-brown liquid
Chemical structure	$  \begin{array}{c}  \text{H} & \text{H} & \text{H} & \text{H} \\    &   &   &   \\  \text{Cl}-\text{C}-\text{C}-\text{S}-\text{C}-\text{C}-\text{Cl} \\    &   &   &   \\  \text{H} & \text{H} & \text{H} & \text{H}  \end{array}  $	$  \begin{array}{c}  \text{CH}_2\text{CH}_2\text{Cl} \\  \diagdown \\  \text{N} \\  \diagup \\  \text{CH}_2\text{CH}_2\text{Cl} \\  \text{CH}_2\text{CH}_2\text{Cl}  \end{array}  $	$  \begin{array}{c}  \text{H} & \text{Cl} \\    &   \\  \text{Cl}-\text{C}=\text{C}-\text{As}-\text{Cl} \\    &   \\  \text{H} & \text{H}  \end{array}  $	$  \begin{array}{c}  \text{Cl} & & \text{H} \\  & \diagdown & / \\  & \text{C}=\text{N}-\text{O} & \\  & / & \diagdown \\  \text{Cl} & & \text{H}  \end{array}  $	
Molecular weight	159.1	204.5	207.35	Not applicable	113.9
Density g/m-3	1.27 (25°C)	1.24 (25°C)	1.89 (20°C)	1.66 (20°C)	
Melting point	14.5 °C	-3.7°C	-8 to 0.1°C (diff. purity)	-24.4°C	39 to 43°C
Boiling point	217.0 °C	256.0°C	190.0°C	190.0°C	129.0°C
Vapor density	5.4	7.1	7.1	6.5	3.94
Vapor pressure (mmHg)	0.072 (°20C)	0.011	0.087 (0°C) 0.394 (20°C)	0.02 (-10°C) 0.248 (20°C) 1.03 (40°C)	3.6 (20°C)
Volatility (mg.m-3)	75 (0°C) 610 (20°C) 2860 (40°C)	13 (0°C) 121 (25°C) 390 (40°C)	1060 (0°C) 4480 (20°C) 8260 (30°C)	240 (-11°C) 2730 (20°C) 10270 (40°C)	20,000 (20°C) 60,000 (35°C)