



GREEN PLANTS

Their Origin and Diversity

Second Edition

PETER R. BELL &
ALAN R. HEMSLEY

CAMBRIDGE

CAMBRIDGE

more information - www.cambridge.org/0521641098

Contents

Preface to the first edition	page ix
Preface to the second edition	x
<hr/>	
1 General features of the plant kingdom	1
Characteristics of the living state	1
Autotrophic and heterotrophic nutrition	1
Structure of the phototrophic cell	2
Origin of the eukaryotic condition	7
Evolutionary consequences of photosynthesis	10
The mobility of plants	13
Life cycles	13
Life cycles of the transmigrant forms	15
Sexual reproduction in later terrestrial vegetation	16
Classification of the chlorophyllous phototrophs	18
<hr/>	
2 The subkingdom Algae: Part I	19
Biological features of algae	19
Algae in which the chlorophyll is wholly or predominantly chlorophyll <i>a</i>	24
Prokaryotic forms	24
Cyanophyta (Cyanobacteria)	24
Eukaryotic forms	30
Rhodophyta	30
Bangiophycidae	31
Florideophycidae	33
Life histories of the Rhodophyta	35
Relationships of the Rhodophyta	36
<hr/>	
3 The subkingdom Algae: Part 2	38
Algae containing chlorophylls <i>a</i> and <i>b</i>	38
Prokaryotic forms	38
Prochlorophyta	38
Eukaryotic forms	39
Chlorachniophyta	39
Chlorophyta	39
Prasinophyceae	40
Chlorophyceae	40
Ulvophyceae	52
Charophyceae	61
Pleurostrophyceae	71
Evolution within the Chlorophyta	71
Euglenophyta	71

4 The subkingdom Algae: Part 3	75
Algae containing chlorophylls <i>a</i> and <i>c</i>	75
Chrysophyta	75
Xanthophyta	77
Bacillariophyta	80
Phaeophyta	83
Haptophyta	93
Dinophyta	94
Cryptophyta	96
Evolutionary trends within the algae	98
Aquatic habitat and evolutionary change	98
Antiquity of the algae	98
Evolution of the vegetative thallus	98
Evolution of sexual reproduction	99
Life histories of algae	100
Importance of the algae in the evolution of plants	101

5 The subkingdom Embryophyta: division Bryophyta (mosses and liverworts)	102
General features of the bryophytes	102
Bryophyta	102
Marchantiopsida (liverworts)	104
Anthocerotopsida (hornworts)	115
Bryopsida (mosses)	117
Relationships of the bryophytes	131
Origin	131
Evolutionary relationships	133

6 The subkingdom Embryophyta (cont.): division Tracheophyta, Part I	135
Early fossil land plants of simple construction	135
“Protracheophytes” and “rhyniophytoids”	135
General features of the tracheophytes	138
Tracheophyta	138
Rhyniopsida	139
Tracheophytes with lateral sporangia (Lycophytina)	141
Zosterophyllopsida	141
Lycopodiopsida	142
Tracheophytes with terminal sporangia (Euphyllophytina)	161
Trimerophytopsida	161
Equisetopsida	162
Cladoxylopsida	170

7 The subkingdom Embryophyta (cont.): division Tracheophyta, Part 2	172
Polypodiopsida (ferns)	172
Extinct orders of ferns	173
The Zygopteridales	173
The Coenopteridales	176
Existing orders of ferns	176
The Marattiales	176
The Ophioglossales	180
The Psilotales	183
The Osmundales	188
The Polypodiales	189
The Hydropteridales	212

8 The subkingdom Embryophyta (cont.): division Tracheophyta, Part 3	218
Primitive ovulate plants and their precursors (Progymnospermopsida)	218
Spermatophytina (seed plants): Gymnosperms	219
Early radiospermic gymnosperms	220
Lyginopteridopsida (Pteridospermopsida)	220
Platyspermic gymnosperms and pine relatives	226
Pinopsida	226
Ginkgoopsida	241
Diversification of radiospermic gymnosperms	244
Cycadopsida	244
Gnetopsida	259
Gymnospermy as an evolutionary grade	267

9 The subkingdom Embryophyta (cont.): division Tracheophyta, Part 4	269
Spermatophytina (cont.): Angiosperms (flowering plants)	269
Magnoliopsida and Liliopsida	269
The emergence of the angiosperms	302
Evolution of morphological features within the angiosperms	307
Recent evolution within families and genera	314
The main trends of angiosperm evolution	315
Glossary	317
Suggestions for further reading	327
Index	331

General features of the plant kingdom

Characteristics of the living state

The living state is characterized by instability and change. The numerous chemical reactions, called collectively metabolism, within a living cell both consume (in the form of foodstuffs) and release energy. Metabolism is indicative of life. Even the apparently inert cells of seeds show some metabolism, but a mere fraction of that which occurs during germination and subsequent growth. Metabolism depends upon the interaction of molecules in an ordered sequence. If this order is destroyed (for example by poisons or heat) metabolism ceases and the cell dies. In some instances it is possible to arrest metabolism without death. With yeast and some tissue cultures, for example, this can be achieved by very rapid freezing at temperatures of -160°C (-265°F) or lower. The cells can then be preserved in liquid nitrogen (-195°C ; -319°F), in an apparently genuine state of "suspended animation", indefinitely. With yeast up to 95 percent of cells of rapidly frozen cultures resume metabolism and growth following careful thawing.

The sources of energy a cell requires to maintain its dynamic state are predominantly compounds of carbon. In addition a cell requires water, since much of the metabolism takes place in the aqueous phase in the cell. Also essential are those materials necessary for the maintenance of its structure which it is unable to make for itself. Prominent amongst these are the nitrogen of the proteins, the commoner minerals (including

phosphorus), and certain other metals and elements which, although needed only in traces, are essential components of a number of enzymes and associated molecules. Occasionally, in isolated cultures of cells, complex organic molecules called vitamins or growth factors must also be supplied from outside.

Autotrophic and heterotrophic nutrition

It is useful to divide organisms into two classes according to the manner in which their needs for organic carbon are met. Those able to utilize simple molecules with single carbon atoms are termed *autotrophs*; those requiring more complex carbon compounds rich in energy (such as sugars) are termed *heterotrophs*. Some organisms are able to switch between these alternative forms of nutrition, depending upon the environment in which they find themselves. These are called *mixotrophs*.

The assimilation of simple carbon compounds by autotrophs, and their transformation into more complex molecules, require an external source of energy. This may be chemical or physical, depending upon the organism. Very many autotrophs (including the whole of the plant kingdom) utilize the energy of light, and are consequently known as photoautotrophs (or simply as *phototrophs*) and the process of assimilation as *photosynthesis*. Only the phototrophs have acquired extensive morphological diversity. Autotrophs utilizing energy from chemical sources (*chemotrophs*)

for the assimilation of carbon are found solely amongst the bacteria.

Phototrophic life is made possible by two unique biological molecules, chlorophyll and bacteriochlorophyll. The chemical differences between them are not profound, but their absorption spectra are distinct, as is their distribution amongst the phototrophs. Bacteriochlorophyll is found only in bacteria and functions mostly anaerobically. Photosynthetic systems based upon bacteriochlorophyll are unable to use water as an electron donor, and consequently there is no evolution of oxygen (*anoxygenic photosynthesis*). Those organisms which contain chlorophyll and which photosynthesize aerobically with the evolution of oxygen constitute the plant kingdom. So defined the plant kingdom is distinct from all other organisms (including the fungi).

Chlorophyll is a complex pigment. It is green in colour, and absorbs light in the blue and to a smaller extent in the red region of the spectrum. The molecule is in part similar to the active group of the blood pigment hemoglobin, but contains at its center magnesium in place of iron. A number of different forms are known (*a, b, c, d* and perhaps *e*), each with its characteristic absorption spectrum. Chlorophyll *a*, which is present in all plants, has the remarkable property of temporarily losing electrons when illuminated. Chlorophyll *b*, which is found in all land plants, assists in the light-harvesting process, but the functions of chlorophylls *c, d* and *e* (p. 77), present in some algae, are not so well known. Chlorophyll is always accompanied by accessory pigments (either carotenoids or phycobilins (biliproteins), or in a few organisms both). The light energy absorbed by these additional pigments can be transferred to the chlorophyll.

As a result of the remarkable photochemical properties of chlorophyll *a* the energy of the incident light is transformed into chemical energy. This leads to the generation in the cell of ATP, and reducing power in the form of $\text{NADPH} + \text{H}^+$ (the light reactions). These two products then bring about the reductive assimilation of atmospheric carbon dioxide in the illuminated cells, the assimilation being initiated by the enzyme ribulose biphosphate carboxylase (RUBISCO), leading to the production of carbohydrates (the dark reactions). The ability to utilize atmospheric carbon

dioxide in this photosynthetic manner releases the organisms concerned from the necessity of an external source of carbohydrate, and their nutritional demands are consequently relatively simple.

Oxygenic photosynthesis, the defining characteristic of the plant kingdom, involves two photosystems. The first (photosystem I) leads to the formation of $\text{NADPH} + \text{H}^+$, and the second (photosystem II) provides a supply of electrons to the chlorophyll of photosystem I. Photosystem II involves the photolysis of water with the production of oxygen. The evolution of oxygenic photosynthesis probably occurred in marine photosynthetic bacteria inhabiting waters close to oceanic thermal vents. At these sites there is a rich supply of minerals, including manganese, a component of the enzyme in photosystem II responsible for the splitting of the water molecule and the release of oxygen. Photosystem II may have appeared only once, or (in geological time) more or less coincidentally at several sites. In any event it was an innovation of immense significance since it made possible the evolution of all subsequent oxygen-requiring organisms, both plant and animal. It is legitimate, therefore, to regard the simplest organisms showing this form of photosynthesis, based upon chlorophyll *a* (as distinct from bacteriochlorophyll), as the earliest plants, opening up a whole new vista of evolution. These early plants, whose living descendants are to be found in the Cyanophyta (p. 24), and Prochlorophyta (p. 38), naturally retained some of the features of their bacterial origins. Nevertheless, freed from the constraints of bacterial photosynthesis, the earliest plants had an evolutionary potential denied to their retarded cousins.

Structure of the phototrophic cell

Chlorophyll does not occur freely in cells, but is always associated with lipoprotein membranes. These membranes surround flattened sacs called *thylakoids*. When the membranes are seen in surface view in the electron microscope (made possible by the special technique of freeze-fractionation)

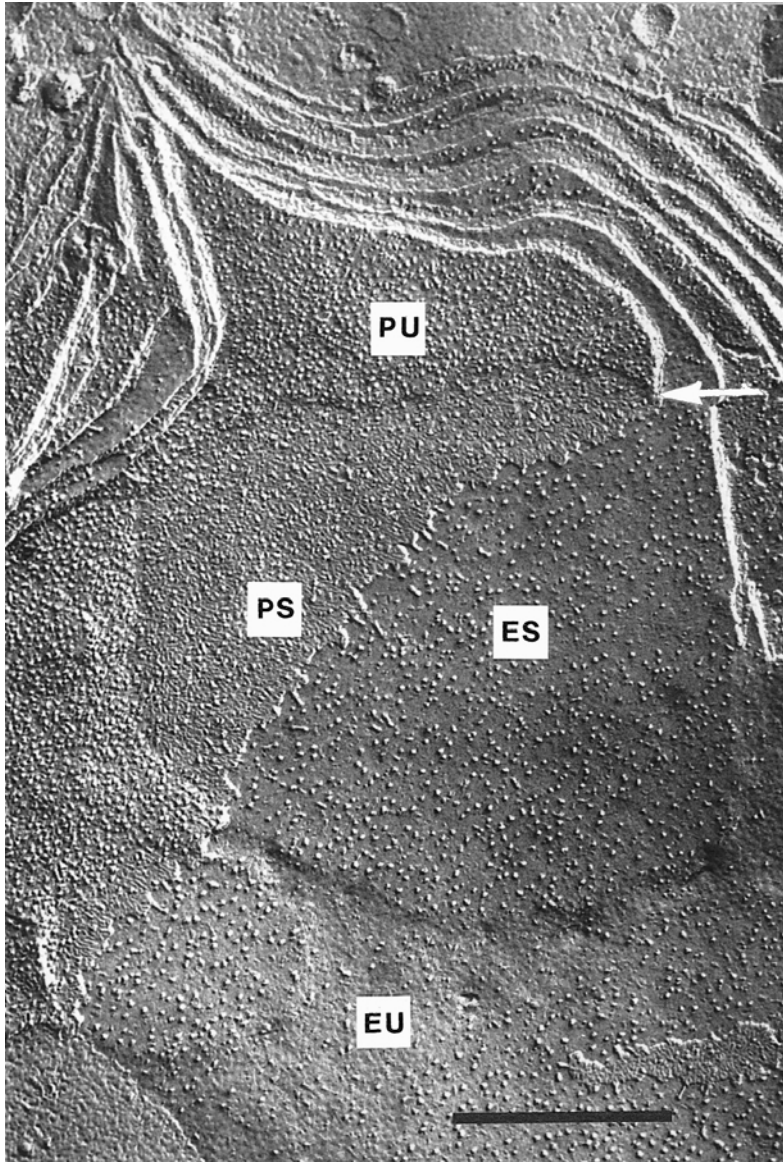

Figure 1.1 Shadowed replica of the thylakoid membranes of the chloroplast of *Euglena* exposed by freeze-fracture. The thylakoids are either single ("unstacked") or paired ("stacked"). Because in the conditions of freeze-fracture membranes are pulled apart, two complementary faces (E and P) are represented in the replica. This reveals that the particles are asymmetrically placed in the membrane (cf. Fig. 1.2). There are also differences in the frequencies of particles in stacked (S) and unstacked (U) membranes. The arrow indicates where the membranes of two adjacent thylakoids come together to form a stack. Scale bar 0.5 μm . (From Miller and Staehelin, 1973. Reproduced from *Protoplasma* 77, by permission of Springer-Verlag, Vienna.)

forms the basis of plant life. In turn the animal kingdom is entirely dependent upon the activity of this membrane, not only for its sustenance, but also for the oxygen of its respiration.

Two distinct kinds of cellular organization are found amongst the phototrophs as a whole. In the first, termed *prokaryotic*, the cell possesses no distinct nucleus, although a region irregular in outline

ture), it is clear that they bear closely packed particles (Fig. 1.1). The larger of these, about 18 nm ($1 \text{ nm} = 10^{-3} \mu\text{m}$) in diameter, are probably the site of the chlorophyll and carotenoids (which, like chlorophyll, are lipid soluble). The anchoring of the chlorophyll and carotenoids in a lipoprotein membrane ensures that they are held in a particular order (Fig. 1.2). Electrons can then flow along well-defined paths to the reaction center at which the radiant energy is converted into chemical energy. The thylakoid membrane is thus the site of the light reactions of photosynthesis, and

and of differing density occurs at the center of the cell. This is referred to as a nucleoid, and the genetic material lies therein. In the electron microscope this region appears fibrillar rather than granular, and the fibrils indicate the site of the deoxyribonucleic acid (DNA). The protoplast of such cells is bounded by a membrane. In phototrophic cells this membrane invaginates into the cytoplasm and forms the thylakoids. Their full development depends upon light. If the cells are grown in the dark the thylakoids disappear or become very reduced. This primordial kind of

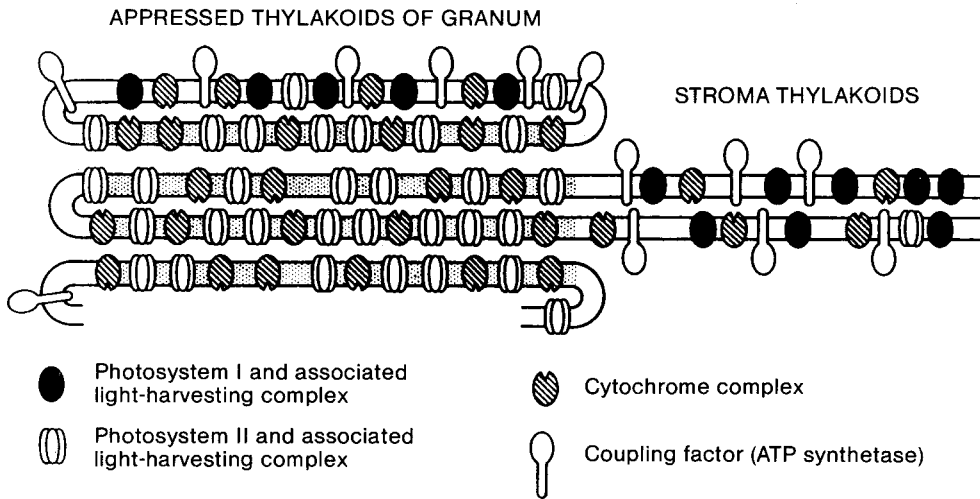

Figure 1.2 The molecular architecture of the thylakoid membrane of a higher plant. The photosystem I complexes are confined to the outer membranes of the grana and to the stroma thylakoids. The stippled regions indicate the appressed membranes of the granum. (From Anderson, Chow and Goodchild. 1988. *Australian Journal of Plant Physiology* 15, modified.)

phototrophic cell is found in both the photosynthetic bacteria and the simplest plants. The fossil record supports the view that the original phototrophs were of this prokaryotic kind. Geochemical evidence of photosynthesis, and remains very suggestive of bacteria and simple cyanophytes, some resembling the living *Oscillatoria* (p. 29), come from early Archeozoic rocks of South Africa and Australia believed to be $3.3\text{--}3.5 \times 10^9$ years old (Table 1.1).

In the cells of all other phototrophic plants the nucleus, the photosynthetic apparatus, and the membranes incorporating the electron transport chain of respiration are separated from the remainder of the cytoplasm by distinct envelopes. Such cells, termed *eukaryotic*, have evidently been capable of giving rise to much more complicated organisms than the prokaryotic ones. The photosynthetic apparatus, which consists of numerous lamellae running parallel to one another, is contained in one or more *plastids*. The envelope of the plastid consists of two (in some algae three or four) unit membranes, the inner of which invaginates into the central space (*stroma*) and generates the thylakoids. The thylakoids in the fully differ-

entiated plastid (*chloroplast*) are usually stacked. In the chloroplasts of land plants the thylakoids are also fenestrated. Consequently numerous small stacks, called *grana*, are formed in place of a single stack, the grana being held together by stroma lamellae (Fig. 1.3). The grana appear in the light microscope as green dots, each about $0.5\mu\text{m}$ in diameter. Although most photosynthesis takes place in the grana, the thylakoids in the stroma also contribute.

Plastids contain both DNA and ribonucleic acid (RNA), and both transcription and translation may occur within them. Plastids thus have some resemblance to phototrophic prokaryotes, although most plastid proteins are encoded solely in the nuclear DNA. The enzyme RUBISCO, essential for photosynthesis and probably the commonest protein in the world, consists of a large and a small subunit. In the green algae (Chlorophyta, p. 39) and in all land plants, the large subunit is encoded in the plastid DNA and the smaller in that of the nucleus. Nevertheless, in some eukaryotic algae, namely the Rhodophyta (p. 30), the Cryptophyta (p. 96) and the whole of the heterokont algae (Table 2.1), both large and small subunits are coded for in the plastid genome. In the prokaryotic algae both subunits are coded for in the DNA of the nucleoid. The possibility exists that coding for one or both units of RUBISCO may also be present in the DNA of a plasmid (p. 8), but this has not been demonstrated.

In the commonest form of carbon assimilation, atmospheric carbon dioxide, having been

Table 1.1 | The geological time scale. Age estimates of Proterozoic and Archaeozoic \pm up to 100 million years.

Eon	Era	Period	Age (in 10^6 years)	First authentic appearance		
Phanerozoic	Quaternary	Holocene and Pleistocene	0–1.6			
		Tertiary (Cenozoic)	Pliocene	1.6–5.2		
	Miocene		5.2–23.3			
	Oligocene		23.3–35.4			
	Eocene		35.4–56.5	Grasses		
	Paleocene		56.5–65			
	Mesozoic	Cretaceous	Senonian	65–88.5		
			Gallic	88.5–131.8	Carpels, flowers, angiosperms	
			Neocomian	131.8–145.6		
			Jurassic	Malm	145.6–157.1	Tectate pollen
			Dogger	157.1–178		
			Lias	178–208		
		Triassic		208–245	Cycadopsida, anthophytes,	
	Paleozoic	Permian	Zechstein	245–256.1	Ginkgoopsida,	
			Rotliegendes	256.1–290	Glossopterids	
		Carboniferous	Pennsylvanian	290–322.8	Pinopsida, Bryopsida,	
			Mississippian	322.8–362.5	Polypodiopsida	
		Devonian	Upper		362.5–377.4	Seeds, fronds, pteridosperms, progymnosperms, early ferns, Cladoxylopsida, Equisetopsida, Trimerophytopsida, Marchantiopsida, heterospory,
				Middle	377.4–386	Zosterophyllopsida,
				Lower	386–408.5	Lycopodiopsida
Silurian			Upper		408.5–424	Rhyniopsida, vascular plants, rhyniophytoids
			Lower		424–439	
			Ordovician Cambrian		439–510 510–570	Triradiate spores Phaeophyta
Proterozoic	Sinian	Vendian	570–610			
		Sturtian	610–800			
	Riphean		800–1650			
Archaeozoic	Animikean		1650–2200	Various algal groups		
	Huronian		2200–2450			
	Randian		2450–2800			
	Swazian		2800–3500			
Hadean	Isuan		3500–3800	Stromatolites and cyanophytes (Cyanobacteria)		
			3800–4560			

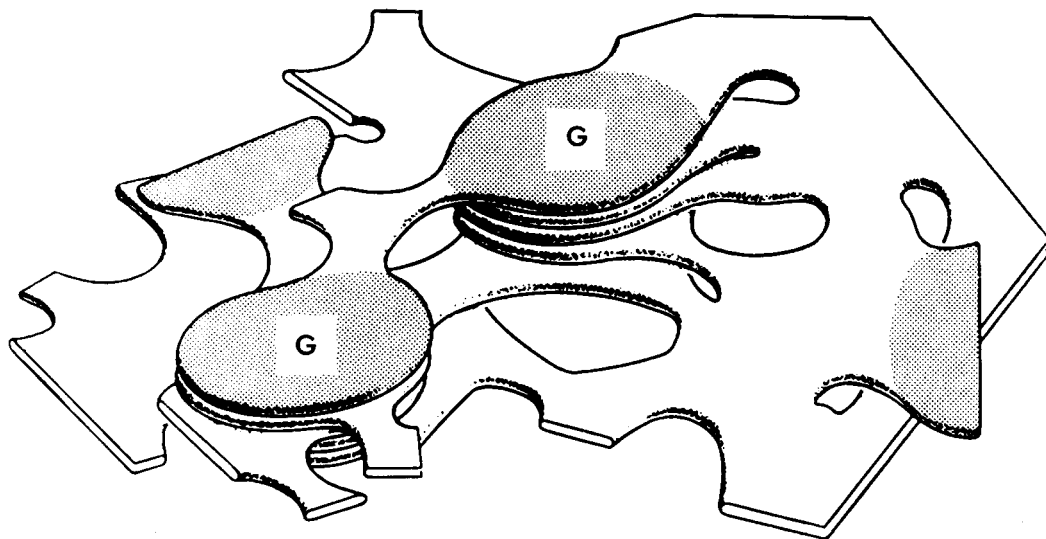

Figure 1.3 Diagram showing the arrangement of the thylakoids in the chloroplast of a higher plant. The stacked regions (grana, G) are visible as green dots in the light microscope. (From an original drawing by Wehrmeyer, 1964. *Planta* 63, modified.)

taken in the presence of RUBISCO into a pentose sugar (ribulose biphosphate), yields two molecules of triose phosphate. These are reduced by the $\text{NADPH} + \text{H}^+$ and ATP, yielding two molecules of glycerin aldehyde. These then enter a complex cycle of reactions (the C₃, or Calvin cycle) leading to fructose and other sugars. A mixture of fairly simple carbohydrates probably leaves the chloroplast, further transformations taking place enzymically in the ground cytoplasm. The disaccharide sucrose, for example, the commonest form in which sugar is transported in the plant, is incapable of traversing the chloroplast envelope and is necessarily formed outside. If the rate of photosynthesis exceeds the rate of outflow of fixed carbon, condensation occurs and starch is deposited in the chloroplast. This may become very conspicuous, the organelle then being termed an **amyloplast**. In some land plants (known as C₄ plants) atmospheric carbon dioxide is taken initially in the chloroplasts of the mesophyll cells into phosphoenolpyruvate (PEP), the enzyme involved in this case being PEP-carboxylase. This leads to the formation of oxaloacetic acid, which is then transformed enzymically into malate or aspartate. These products migrate to special

chloroplasts in the bundle sheath cells, which are distinguished from those of the mesophyll by lacking grana, but they do contain RUBISCO. Here the malate and aspartate are reconverted into oxaloacetic acid. The carbon dioxide is thereby freed and, as in C₃ plants, is assimilated into ribulose biphosphate and enters directly into the Calvin cycle (Fig. 1.4). PEP-carboxylase has a higher affinity for carbon dioxide than RUBISCO, and can withstand higher temperatures. Further, the combined C₄/C₃ systems have less need of water in relation to the quantity of carbon assimilated. Consequently vegetation of hot and dry (including “physiologically dry”) habitats, such as deserts and salt marshes, often contains a high proportion of C₄ plants. A few plants are ambivalent. *Eleocharis vivipara* (a marsh plant), for example, is a C₄ plant under terrestrial conditions but C₃ when submerged.

The organelle in eukaryotic cells containing the respiratory membranes is termed a **mitochondrion**. Although there are structural and organizational similarities between mitochondria and plastids, in most photosynthesizing cells the mitochondria have far less internal differentiation. So far as carbon is concerned, the functions of these two organelles are opposed: that of the chloroplast is **reductive carboxylation**, that of the mitochondrion **oxidative decarboxylation**. In certain conditions (notably with a low partial pressure of carbon dioxide) RUBISCO can act as an oxidase,

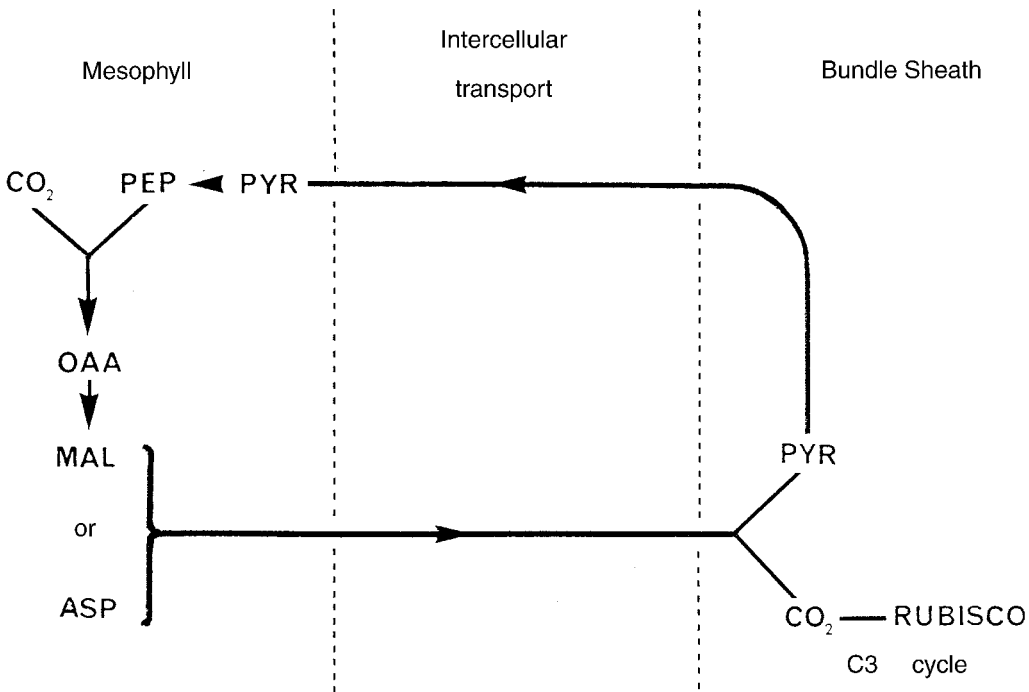

Figure 1.4 The essential features of C₄ photosynthesis. PEP, phosphoenolpyruvate; OAA, oxaloacetic acid; MAL, malate; ASP, aspartate (aspartic acid is the amino acid corresponding to malic acid); PYR, pyruvate. There are biochemical variations between species, but the general pattern is retained.

resulting in a loss of fixed carbon (photorespiration). This may have had a significant ecological effect at certain periods of the evolution of land plants in geological time.

Origin of the eukaryotic condition

Although it seems beyond doubt that the prokaryotic condition preceded the eukaryotic (the first eukaryotic algae probably appeared about 2.1×10^9 years ago), the manner in which the transition occurred is by no means clear. A commonly accepted, and little criticized, view (originally put forward in 1905) is that mitochondria and plastids are derived from prokaryotes which entered as endosymbionts into a primordial cell, itself prokaryotic and presumably heterotrophic. The presence in the cytoplasmic organelles of a nucleoid, their

possession of transcription and translation systems closely resembling those found in bacteria, and the similarity in size between the ribosomes of organelles and those of bacteria (the ribosomes of eukaryotic ground cytoplasm tend to be larger) provide strong evidence in support of this theory. Further, organisms which appear to have arisen by endosymbiosis are well known. In *Glaucozystis* (Fig. 2.9) and *Cyanophora*, unicellular organisms found occasionally in shallow fresh water, for example, the photosynthetic component of the cell is made up of one or more units resembling blue-green algal cells. These have accordingly been termed "cyanelles" (p. 27). Other possible examples of endosymbiosis are found in the Cryptophyta (p. 97). Here the chloroplast contains a "nucleomorph", which, since it is surrounded by a double membrane, may represent the remnant of, in this case, a eukaryotic endosymbiont.

The theory (in its modern form) envisages that, in the primordial eukaryotes, the prokaryotic endosymbionts became integrated into the physiology of the composite cell, contributing some of their genetic information to that in the nucleus, and in so doing losing their individual identity and sacrificing much of their autonomy.

Attractive though this theory is, it has obvious difficulties. Organisms, such as *Glaucocystis*, which appear to be undoubtedly endosymbiotic in origin, are evidently exploiting successfully an ecological niche, and have probably done so since early in the diversification of cellular life. They can therefore be legitimately regarded as models of stability, and, far from being an indication of how the eukaryotic condition arose, are splendid examples of “dead ends” without evolutionary potential. Evidence of selective pressure favoring the complete assimilation of the invasive organisms, although conceivable, is so far lacking. Also required is a credible mechanism for the transfer of essential components of the invaders’ genomes, through an alien cytoplasm to the nuclei or nucleoids of the hosts and the incorporation of this information in a (to them) foreign DNA. Further, is the nucleus itself of endosymbiotic origin? There are so many unanswered questions that it would be unjustified to fail to consider alternative possibilities.

The principal alternative view rests upon the occurrence in prokaryotes of plasmids, circles of DNA lying in the cytoplasm apart from the nucleoid. The genetic information in the plasmid is commonly represented also in the DNA of the nucleoid. The nucleotide sequences in a plasmid frequently code for a specific function. Photosynthetic membranes, and also respiratory membranes (mesosomes), are features of many prokaryotes. These membranes arise as invaginations of the plasmalemma. The cyanophytes and prochlorophytes (or their antecedents), the only prokaryotes displaying oxygenic photosynthesis, are obvious candidates for the origin of chloroplasts, a view strengthened by the many molecular similarities between them. Plasmids are indeed widespread in cyanophyte cells (but not yet reported in those of the prochlorophytes). Although it has not yet been possible to ascribe any precise function to the plasmids of the cyanophytes, it is not unreasonable to envisage a plasmid being associated with a photosynthetic membranous invagination in a primitive cyanophyte, and containing genes modulating its development and function. This possibility is strengthened by the evidence for the presence of regulatory genes on a plasmid regularly asso-

ciated with the photosynthetic membrane system of the bacterium *Rhodospirillum rubrum*. If the peripheral complex of a cyanophyte, similarly endowed, were taken into the body of the cell, a rudimentary chloroplast would result. A similar translation affecting a peripheral respiratory membrane associated with an appropriate plasmid would lead to a rudimentary mitochondrion. Each would contain genetic information shared wholly or partly with that in the nucleoid or nucleus, a feature of mitochondria and plasmids. No substantial transfer of essential genetic information would be required following the internalization of these membranous complexes into the body of the cell. It would follow that the correspondence between the genome of a plastid and that of the nucleus of its cell was analogous to that between a plasmid and the nucleoid in a prokaryote. This relationship would represent the persistence of an ancient feature, not the emergence of a new one.

Experiments with monolayers of polar lipid on the surface of water show how movement of membranous complexes from the periphery of a naked cell to the interior might have come about. When a lipid film is compressed, the film folds into the aqueous phase, so reducing its area. This, however, is an unstable situation. The folds in the aqueous phase become instantaneously detached, relieving the surface film of compression and restoring its continuity. The folds, now submerged, coalesce to form spheres and cylinders, themselves filled with water. Since both the inner and outer faces are now clearly hydrophilic, polar groups must be exposed on both surfaces. The lipid faces of the folds must therefore have come together, forming a bimolecular leaflet. One of the essential elements in the collapsing process is seen as the marked difference in viscosity between air and water, allowing air to escape rapidly from the folds, leading to the apposition of the two lipid layers.

It is not unreasonable to envisage a natural membrane, forming the interface between two phases differing in viscosity as sharply as protoplasm and water, behaving, under compression, in a manner analogous to that of a lipid film. If the folds formed adjacent to, or around, an already existing invagination of the bounding mem-

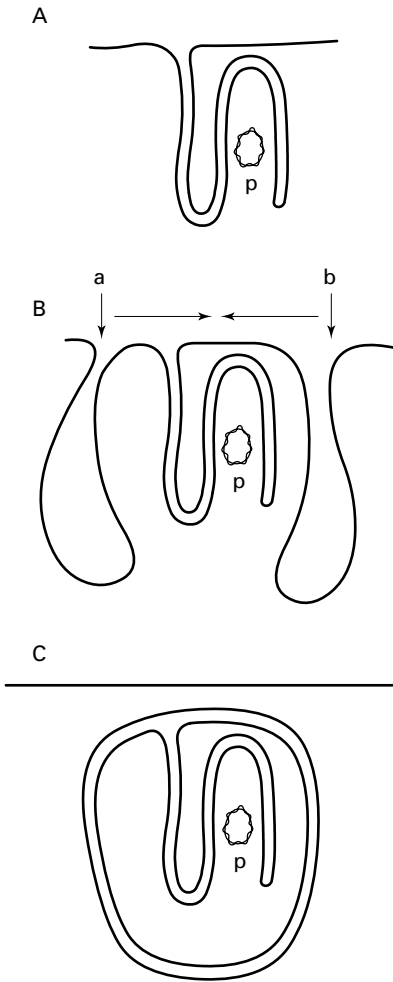

Figure 1.5 Diagrammatic representation of how a peripheral membrane system associated with a plasmid (p) could have become encapsulated and internalized as a consequence of compression of the bounding membrane. (A) Part of the bounding membrane of a prokaryote furnished with a photosynthetic invagination associated with a regulatory plasmid. (B) The bounding membrane is compressed and forms folds. Since the protoplasm adheres strongly to the membrane and is more viscous than the surrounding water, the membrane is dragged inward. If the volume of the cell is shrinking as a consequence of exosmosis, this effect would be enhanced. (C) Excess water is expelled from the folds so that the membranes lie closely parallel to each other, separated only by hydrated surface molecules (possibly glycoproteins). The inner extremities of the folds come together and fuse. Simultaneously the bounding membrane suffers instantaneous collapse. The margins of the folds (a, b) come together, so restoring continuity to the surface, and at the same time releasing a double-membraned inclusion to the interior. The area of the surface is thereby reduced, freed from compression, and structural stability is regained. (Based (by analogy) on experiments by R. J. Goldacre on the collapse of surface films of polar lipid under compression, described in Danielli, Pankhurst and Riddiford (eds.) 1958. *Surface Phenomena in Chemistry and Biology*, pp. 278–98. Pergamon, London.)

brane, the result would be that the invagination was carried, bounded by a double membrane, into the body of the cell (Fig. 1.5). In natural conditions, compression of the bounding membrane could be caused by, for example, exosmosis (if the prokaryote were splashed into a hypertonic pool), or even by mechanical pressure on naked cells arising from turbulence as streams cascaded over rocks. These conditions probably occurred frequently at the beginnings of cellular life.

The nucleus may have arisen in a similar manner, if the DNA of the genome were associated with an invagination of the plasmalemma, as in some existing bacteria. Indeed, internalization of the genome may have happened independently of the formation of plastids and mitochondria. Species of *Gemmata* and *Pirellula*, plancomycete

bacteria, have been found in which the nucleoid is surrounded by an envelope. In *Gemmata* this consists of two membranes, the outer of which is connected with the plasmalemma, but in *Pirellula* the envelope is single.

It seems likely that a naked membranous sac, furnished with peripheral invaginations which penetrate contents that are denser than the surrounding medium, presents an unstable biophysical situation, particularly if the bounding membrane is compressed. Stabilization, relieving the membrane of compression, is achieved spontaneously by the internalization of the peripheral complexes. The current development of techniques for the production of compound vesicular bodies, consisting of vesicles bounded by lipoidal membranes lying free within the parent vesicle, raises the possibility of being able to mimic the internalization of peripheral membranous complexes in an experimental system using artificial cells. If it proves possible to explain the origin of the eukaryotic condition in terms of membrane biophysics, based upon a repeatable experimental system, the endosymbiotic hypothesis, which

rests upon unverifiable evolutionary speculations, can at last be returned to history. The encapsulation and internalization of membrane systems originally attached to the plasmalemma may indeed have occurred many times with primitive cells, unprotected by a wall or mucilage. The emergence in evolution of firm or gelatinous cell walls, protecting a range of the earliest cells from the effects of compression, allowed the persistence of simple prokaryotes with peripheral photosynthetic and respiratory membrane systems into the later eukaryotic times. Although microtubules and actin microfilaments, structural proteins of the cytoplasm, are not found in bacteria, proteinaceous tubular elements ("rhapidosomes"), about 24 nm in diameter, occur in the cytoplasm of some cyanophytes (p. 29). Although not identical with the microtubules of eukaryotes, they may have given the cells of the photosynthetic prokaryotes an additional stability that ensured their survival.

Following the translation of the photosynthetic and respiratory compartments into the body of the cell, these compartments have retained many of their prokaryotic features in subsequent evolution. The invasion of the bounding membrane appears, however, to have led to innovations in the remaining cytoplasm. The endoplasmic reticulum (which retains connections with the outer membrane of the nuclear envelope) and the Golgi bodies are both membranous structures, characteristic of even the smallest eukaryotic cells (e.g., *Osteococcus*, p. 40). The ribosomes, ubiquitous in the cytoplasm, increased in size, reaching diameters some 50 percent greater than those of the ribosomes of mitochondria and plastids, and of prokaryotic cells. Concomitantly, the DNA of the genome became organized into chromosomes, probably a consequence of the nuclear envelope allowing a much closer control of the metabolism and assembly of the proteins (particularly histones) associated with the folding of the DNA. This led to the complex known as chromatin, and its parceling into a definite number of regularly reproducible bodies, the chromosomes.

Evolutionary consequences of photosynthesis

It seems beyond doubt from the fossil record of life, and from the biological and geological inferences that can be drawn from it, that life began in water. The earliest forms of life remain conjectural, but were probably chemotrophic, accompanied fairly rapidly (in evolutionary time) by heterotrophs feeding upon them. Nevertheless, phototrophs probably also appeared relatively early. Those which contained or acquired chlorophyll (as opposed to bacteriochlorophyll), and which further developed oxygenic photosynthesis, gave rise to the plant kingdom. The descendants of these early aquatic forms, which still in the main exploit the watery environment, are termed algae (Chapters 2, 3 and 4). They have many biochemical, physiological, ecological and structural features in common. For these reasons they include the prokaryotic forms placed in the Cyanophyta and Prochlorophyta, which, although retaining some bacterial features, are clearly superior to these lowly forms in their possession of oxygenic photosynthesis and their general algal characteristics. Although some unicellular algae have attained morphological complexity (e.g., the dinoflagellates; p. 94), others represent the simplest plants still in existence. Apart from the unicellular prokaryotes, such as *Prochlorococcus* (p. 38), some unicellular eukaryotes are also minute. *Osteococcus tauri* (p. 40), for example, is probably the smallest eukaryotic organism known. The cells do not exceed 1 μm in width, lack a cell wall, and contain only a single plastid and a single mitochondrion. *Osteococcus* has so far been found only in the plankton of Mediterranean lagoons, but *Micromonas* (Fig. 1.6), which has a similarly simple cell but is provided with a flagellum, is abundant in the oceans. Relatively early, however, even in the prokaryotes (p. 29), multicellularity appeared in algal evolution, yielding a diversified algal flora whose descendants are still with us today.

At some stage, possibly in the Silurian period (Table 1.1) or even earlier, vegetation began to colonize the land. These early colonists, and consequently the whole of our existing land flora,

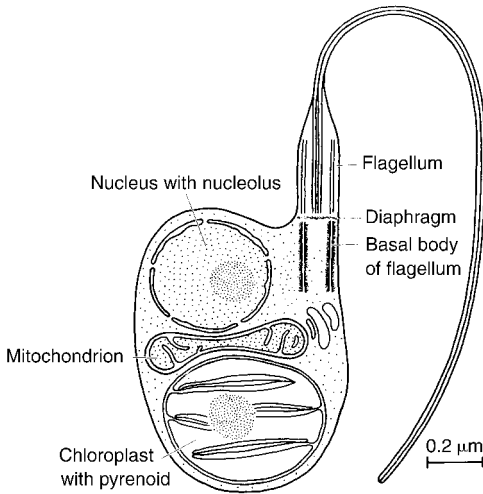

Figure 1.6 *Micromonas pusilla*. Form and internal organization. Only the central microtubules run into the extension of the flagellum. *Micromonas* belongs to a small group of green algae of doubtful affinity. (From electron micrographs by Manton. 1959. *Journal of the Marine Biological Association of the United Kingdom* 38.)

almost certainly emerged from that group of aquatic plants today represented by the green algae (Chlorophyta). The Chlorophyta and the land plants (a term which means plants adapted to life on land and not merely plants growing on land) have the same photosynthetic pigments, basically the same photosynthetic apparatus, and share many metabolic and physiological similarities (pp. 131, 132).

Any consideration of the evolution of a photosynthesizing land flora must therefore take into account the physiological features of the green algae, and how these may have been modified in the transition to terrestrial life. Recent research into algal environments is yielding much information relevant to this problem. It is commonly found, for example, that from 5 to 35 percent of the light striking the surface of a lake or sea is reflected, the actual amount lost depending upon the angle of incidence. The light penetrating the water is then gradually absorbed as it advances, so that up to 53 percent of the radiation passing the surface may be dissipated as heat in the first meter (39 in.). Consequently, in warm and temperate regions, the rate of photosynthesis of submerged plants is normally controlled by the amount of

light reaching them, and not by the amount of carbon dioxide in the water. We can see at once that the first colonists of land, emerging on to bare mineral surfaces, would almost certainly have had to contend with irradiances strikingly higher than those experienced by their aquatic ancestors. This would have provided opportunities for greatly increased photosynthesis.

Another discovery of recent research, also very relevant to the problem of the colonization of the land, is the surprising extent to which algae release materials derived from photosynthesis, both aliphatic molecules and phenolics, into the surrounding water. In Windermere in the English Lake District, for example, up to 35 percent of the total carbon fixed may be lost in this way. Even in land plants, losses of fixed carbon (as soluble or dispersible carbohydrates and phenolics) have been detected from roots. Some estimates of losses by this process of *rhizodeposition* over the growing season have put it as high as 30 percent. Other losses from land plants may occur from leaves as gaseous hydrocarbons, notably isoprene (2-methyl-1,3-butadiene). In oak (*Quercus*) and aspen (*Populus*), isoprene typically amounts to 2 percent of the fixed carbon at 30 °C (86 °F). This loss can increase tenfold with a 10 °C (18 °F) rise in temperature. Isoprene is also produced by mosses (p. 118) and ferns, but not apparently by liverworts or *Anthoceros*. Isoprene production may have been an adaptation acquired by land plants as they came on to land, possibly providing some thermal protection in conditions of strong insolation.

Despite losses of fixed carbon by land plants, it seems inevitable that as vegetation advanced from estuarine flats, or from littoral belts subject to periodic inundation, on to relatively dry substrata and an environment of freely diffusible carbon dioxide and generally higher irradiances, carbon fixation would have been promoted. The generally high levels of atmospheric carbon dioxide at the time of the landward migration would have depressed loss of carbon by photorespiration and in general stimulated fixation. Proportionately more of the fixed carbon would have been conserved within the plant body than in the aqueous environment. The plants invading the land appear to have met these environmental challenges not by any significant change in the

structure, composition or efficiency of the photosynthetic membrane, but by increased removal of the fixed carbon from the general metabolism. In this way the accumulation of very large, and possibly toxic, quantities of carbohydrate in the cells was effectively prevented. Cell walls, consisting of cellulose and hemicellulose, became thicker. Condensation products such as resin, phlobaphene and lignin became conspicuous, and have remained so in the more primitive vascular plants. The early land plants may also have produced substantial quantities of mucilage (largely highly hydrated polysaccharides). This feature is still encountered in a number of thallose liverworts, such as *Anthoceros*, whose general morphology and anatomy may resemble that of at least some of the transmigrants (p. 117). Significantly, the mucilage is often extruded through pores, each bounded by two cells. The resemblance of these pores to simple stomata can be so striking that the identification of similar configurations in early fossil material with stomata must be made with caution.

The progressive layering of cellulose microfibrils on to the growing cell walls of land plants probably tended to make the angles rounder, thus setting up the tensions which, during cell expansion, led to the appearance of air spaces at the interstices. Spaces of this kind, although found in some of the larger brown algae, such as the kelps (p. 89), do not appear in the "green" line of evolution (as represented by living species) until the gametophytes (e.g., *Marchantia*, p. 105) and sporophytes (e.g., *Funaria*, p. 126) of bryophytes. These spaces are an important feature of land plants, ensuring that the plant body is ventilated with saturated air. Increased carbon would also facilitate the synthesis of the fatty acids and phenolics which go to form cutin. In the form of the cuticle, covering all cell-air interfaces, and with the assistance of the regulatory stomata, cutin makes possible the regulation of the loss of water from the plant body. This enables the plant body to maintain a state of hydration independent (within limits) of the supply of soil water and the saturation deficit of the atmosphere, a feature known as *homoiohydric*. A possible precursor of the cuticle is seen in at least one green alga (*Cladophorella*), which grows on damp mud and is covered on its

upper surface by a material which, judging by its resistance to acids and oxidizing agents (although its composition has not yet been investigated by modern spectroscopic methods), closely resembles cutin. Compounds resistant to both chemical degradation and natural decay, probably aliphatic in origin, have been located in the cell walls of other green algae. Significantly, these algae belong to the class Charophyceae (p. 61), which contains the algae believed to be closest to those which gave rise to the land plants (p. 131). A cuticle has been a feature of land plant evolution since at least the Ordovician (Table 1.1).

Comparison of the green algae and the lower land plants thus reveals interrelated modifications of the anatomy and of the utilization of the fixed carbon which facilitated the establishment of homoiohydricity, and allowed the invasion of land surfaces subject to intermittent dryness. Homoiohydricity also made possible more stable growth rates with consequent ecological success. The gametophytes of the land plants, however, tended to remain small and with limited control over their degree of hydration (*poikilohydric*). Nevertheless, some mosses (p. 121) and the prothalli of some lower land plants (e.g., ferns; p. 203) are able to recover from quite severe desiccation.

Sporopollenin (a complex polymer formed by the condensation of aliphatic and phenolic molecules), of doubtful occurrence in green algae, takes on an essential rôle in land plants. Although varying in composition with phylogenetic history, its sealing properties remain a general characteristic. It features in the protective coats on the spores of land plants, and in some instances coats membranes within plants separating reproductive regions from the surrounding somatic tissue, as, for example, the peritapetal membrane in many angiosperm anthers (p. 287).

Lignin, of which the phenolics of algal cells may have been a precursor, is a product of cells undergoing programmed death. It is laid down within cell walls and fills the spaces initially occupied by water, thus both sealing and strengthening the wall. Tracheid-like cells may have evolved from the elongated cells normally formed at the center of axes. Selection, acting upon a genetically controlled program of cell death at this site, could have led to cells with thickened walls which had

both a structural and a conducting function. Initially, the rudimentary tracheids were probably formed in discontinuous patches, as they are found today in the gametophyte of *Psilotum* (p. 187), and at that stage the conducting function may not have been well developed.

Overall, natural selection ensured that those forms survived in which the various destinations of the fixed carbon were not disadvantageous to the growth and reproduction of the plant as a whole. The lignification of tissue, for example, permitted the continued evolution of xylem, providing both a skeleton supporting the plant in space and an effective system for the transport of water and solutes. Massive plant bodies, which seem to have appeared relatively early in the evolution of the land flora, also made possible the confinement of photosynthesis to specialized regions, such as leaves and fronds. The amount of assimilation per unit mass of the plant was thereby reduced. Simultaneously, the increase in the amount of living, but non-photosynthesizing, tissue naturally increased the call on metabolizable assimilates. Both factors ensured that the multicellular colonists of the land remained in balance with their environment without interference with the fundamental features of photosynthesis.

In the course of evolution many complex and bizarre forms of growth have appeared in land plants, but the material from which they are fashioned has remained predominantly carbon, extracted from the atmosphere. This diversity can be related to the tetravalent nature of carbon, and the strength of its covalent bonding, permitting the formation of molecules with stable carbon chains and rings, and opening the possibility of a great range of organic compounds. Had not the photosynthetic fixation of this versatile element arisen on the Earth's surface, plant life, and animal life (which is dependent upon it), would have been impossible. Indeed, it is difficult to conceive of any alternative form of life appearing in its absence. The chain-forming properties of the related element silicon, for example, are, in comparison, negligible.

The mobility of plants

Although the earliest plants were probably unicellular and soon acquired motility of the kind seen today in *Chlamydomonas* (Chapter 3), this appears to have been rapidly lost in the evolution of higher forms (although often retained in their gametes). Multicellularity, the cells remaining cemented together by polysaccharides, became the dominant condition, cell separation being confined to sites of reproduction. Although this led, already by the Devonian, to the existence of large and firmly anchored land plants, these are naturally at a disadvantage, not shared by the higher animals, at times of natural catastrophe, such as volcanic eruption or fire. Plants, however, very frequently possess a remarkable mobility, or at least a ready transportability by agencies such as wind and water, in their reproductive bodies. Fern spores, for example, have been caught in aeroplane traps in quantity at 1500 m (5000ft) and even higher, and the hairy spikelets of the grasses *Paspalum urvillei* and *Andropogon bicornis* have been encountered at 1200 m (4000ft) above Panama. Lakes, seas and the coats and feet of animals also play their part in distributing plants. A splendid example of oceanic distribution is provided by the coconut palm (*Cocos nucifera*), which frequently fringes tropical beaches. The nuts, dropping into the sea, float for long distances and germinate where washed ashore. The pan-tropical distribution of the palm is readily accounted for in this way. In plants, therefore, the immobility of the individual is frequently compensated for by the mobility of the species, and devastated areas and new land surfaces become colonized with amazing rapidity and effectiveness.

Some plants (e.g., *Glechoma*) produce stolons which appear to explore the neighboring ground. Since the plantlets becoming established on richer areas come to dominate the stand, this behavior has been fancifully referred to as "foraging".

Life cycles

Although developmental cycles are known in the prokaryotic Cyanophyta (p. 28), a well-defined

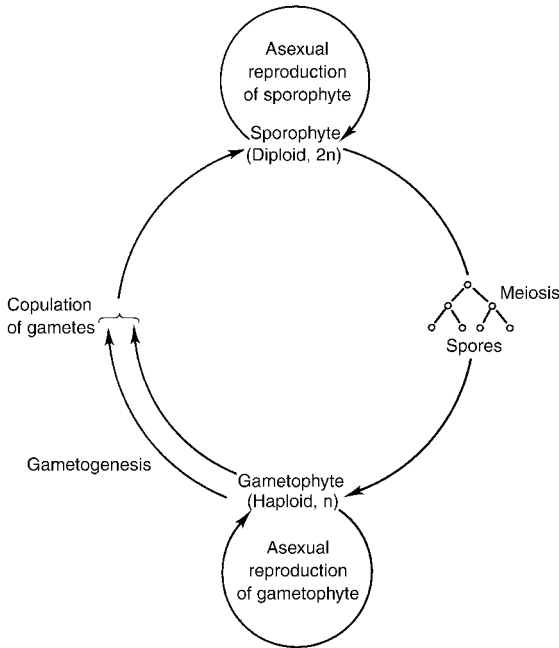

Figure 1.7 The life cycle of autotrophic plants generalized. The large circle represents sexual reproduction. Only relatively few species display all the reproductive potentialities shown.

cycle involving meiotic segregation of the genetic material and its subsequent recombination by sexual fusion is found only in eukaryotic phototrophs. That part of the cycle in which the nucleus contains a single set of chromosomes is termed *haploid*, and the complementary part of the cycle in which two sets are present *diploid*. The cycle is seen at its simplest in the unicellular algae of aquatic environments (Chapters 2, 3 and 4), where haploid individuals in certain circumstances behave as gametes and fuse, so forming a *zygote*. The zygote, which contains a diploid nucleus, either undergoes meiosis at once, or only after some delay, in which case the diploid condition can be thought of as having an independent existence. Either the haploid or the diploid phase, or both, may be multicellular. The multicellular plant is called a *gametophyte* if it produces gametes directly, and a *sporophyte* if it produces, following meiosis, individual cells (called spores or meiospores) which either behave as gametes immediately or develop into game-

tophytes. Each phase may also multiply itself asexually. These various possibilities are summarized in Fig. 1.7.

A life cycle is thus basically a nuclear cycle, and it is not necessarily accompanied by any morphological change. In the algae *Ulva* (p. 54) and *Dictyota* (p. 92), for example, the gametophyte and sporophyte are superficially indistinguishable, and it is necessary to observe the manner of reproduction in order to identify the phase of the cycle to which any individual belongs. Such a life cycle is termed *isomorphic* (or homologous). Frequently, however, the two phases of the cycle have different morphologies, one often being less conspicuous than the other, and sometimes parasitic upon it. These cycles are termed *heteromorphic* (or antithetic). Although the algae show both isomorphic and heteromorphic life cycles, those of land plants are exclusively heteromorphic. Occasionally there may be a morphological cycle without a corresponding nuclear cycle, as in the apogamous ferns (p. 210), but this is regarded as a derived condition.

Gametes are always uninucleate, and, when motile, usually naked cells. In the simplest form of sexual reproduction, termed *isogamy*, the two gametes involved in fusion are free cells and morphologically identical. Nevertheless, detailed investigations continue to show that gametes from the same parent rarely fuse. Some measure of self-incompatibility, and hence physiological differentiation between the parents, appears to be the general rule.

Isogamy was probably the most ancient condition, and this appears to have been succeeded by *anisogamy*. Here the gametes, although still free cells, are morphologically dissimilar, but usually differ in little more than size. The larger, which may also be less mobile, is called the female. The extreme form of anisogamy is *oogamy*, in which the female gamete, now called an egg cell or ovum, is large, non-motile, and filled with food materials. The egg cell may either float freely in water, as in the alga *Fucus*, or be retained in a chamber, as in some algae and all land plants. The chamber bears various names according to the group of plants being considered. Since the progression from isogamy is accompanied in many algal groups by an increase in somatic complexity,

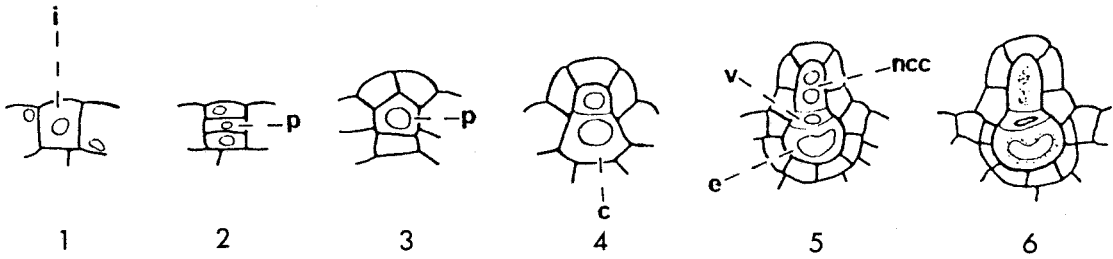

Figure 1.8 The development of an archegonium as seen in a fern: i, archegonial initial; p, primary cell of the axial row; c, central cell; v, ventral canal cell; e, egg cell; ncc, neck canal cell. Stage 6 indicates a mature archegonium. The neck canal nuclei are breaking down and the ventral canal nucleus is becoming pycnotic. The egg nucleus is enlarging and becoming irregular in outline.

it seems very probable that this morphological progression is also a phylogenetic one.

In several instances of sexual reproduction it has been shown that one or both gametes, or the gametangia in which they are produced, liberate traces of chemical substances, termed pheromones (or gamones), which cause the appropriate gametes to approach each other. The chemistry of these pheromones varies widely. In some algae they are hydrocarbons (p. 84) and in others (p. 44) glycoproteins. In the ferns the male gametes are attracted to the opened egg chambers by a pheromone which may be malic acid, a component of the Krebs cycle of respiratory decarboxylation. This substance is known to have a striking chemotactic effect *in vitro*.

Life cycles of the trans migrant forms

The transition to a terrestrial environment clearly presented a number of problems in relation to sexual reproduction. Although all land plants are oogamous, and are presumably derived from oogamous algae, fluid was still necessary in the initial land plants to allow the motile male gametes to reach the stationary female. This problem appears to have been met first by the egg becoming enclosed in a flask-shaped chamber, the *archegonium*, in the neck of which the male gametes accumulate, and second by the male gamete becoming an efficiently motile cell. The male gametes of the lower archegoniate plants (Chapters 5, 6 and 7), termed *spermatozoids* (or antherozoids), are

remarkable cytological objects. Each is furnished with two or more highly active flagella, and both the cell and nucleus have an elongated snake-like form, well suited for penetration of the archegonial neck. Dependence upon water is thus reduced to the necessity for a thin film in the region of the sex organs at the time of maturity of the gametes.

The archegonium is common to all the lower land plants, but its origin remains tantalizingly obscure. It may have appeared immediately before the colonization of the land, possibly as a consequence of morphogenetic tendencies seen today in association with the eggs of some Charophyceae, and certain red algae. Regrettably, however, the antecedents of the transmigrant forms have left no clear representatives amongst living algae. Nevertheless, whatever the exact time of the evolution of the archegonium, there are no compelling reasons for regarding it as having been evolved more than once. The archegonium of the living plants has a relatively uniform ontogeny and cytology. The initial cell lies in the outer layer of cells (Fig. 1.8). Two periclinal divisions give rise to a vertical row of three cells, of which the middle cell is the primary cell of the axial row. This divides, forming the central cell and the neck canal cell initial. The division of the central cell yields, below, the egg cell and, above, the ventral canal cell. The nucleus of the neck canal cell divides a number of times (depending upon the systematic position of the archegoniate), but the cell itself commonly remains undivided. The neck is formed by tiers of cells derived from the upper cell of the initial row of three (Fig. 1.8). The lowermost cell of this row gives rise to the cells forming the jacket of the egg cell. The length of the neck and the number of canal cells is significant in bryophytes (p. 108), but negligible in advanced archegoniates, such as cycads (p. 250).

The ferns occupy an intermediate position (Fig. 1.8). In advanced archegoniates, division of the central cell is often not followed by cytokinesis, and the egg nucleus and ventral canal nucleus share a common cytoplasm (e.g., *Ephedra*, p. 266).

With a few exceptions, the fossil record indicates that the most primitive forms of land plants were probably all archegoniate. Notable amongst the likely exceptions is *Protosalvinia*, an enigmatic Devonian plant (p. 93). Its structural and morphological resemblances to dichotomously branched furoid algae (p. 89) suggest that algal groups other than the Chlorophyta may also have experimented with life on land, but with no lasting effect. There is little to challenge the view that the successful colonization of the land was a unique event, brought about by evolutionary progression from the Chlorophyta, in which the perfection of the archegonium played a cardinal rôle.

If the transmigrant forms were archegoniate, what was the nature of their life cycles? This is largely a matter for conjecture. However, as will be seen in later chapters, except for approaches to isomorphy in rhyniophytoid plants (Chapter 6), the living lower archegoniate plants possess markedly heteromorphic life cycles in which the conspicuous phase is either the gametophyte (Bryophyta) or the sporophyte (Lycopodiopsida, Equisetopsida, Polypodiopsida). The transmigrants possibly had an intermediate position, with more or less isomorphic cycles, although there is evidence that, even as early as the Lower Devonian, simple vascular plants had gametophytes with bryophyte-like features (p. 115). The cycle in which the sporophyte was the most highly developed phase clearly had the greater evolutionary potential, since it is characteristic of all forms of higher plant life.

Sexual reproduction in later terrestrial vegetation

An important step in the evolution of sexual reproduction on land was undoubtedly the emergence in the archegoniate plants of heterospory. This involves the production of spores of two sizes, the larger giving rise to a wholly female gametophyte and the smaller to a male. In homosporous

archegoniate plants the gametophyte commonly passes through a male phase before becoming female, although it may become male again later. The simultaneous production of viable male and female gametes is unusual. In the primitive heterosporous plants, however, the small female gametophyte formed on germination of the megaspore produces one or a few archegonia in a very short time. The microspore also develops rapidly, and spermatozoids are soon liberated from the diminutive male gametophyte. Further, the food reserves of the megaspore provide for the rapid development of the embryo (in the heterosporous fern *Marsilea* (p. 214), for example, the new sporophyte emerges within 24 hours of fertilization, compared with about one week in a homosporous fern). Heterosporous reproduction is thus coupled with a reduction of the time spent in the gametophytic phase. The shortening of the life cycle increased the rate at which new forms could appear, and hence promoted evolution.

In higher archegoniate plants (Chapter 8) we see how sexual reproduction becomes increasingly independent of water. These archegoniates are exclusively heterosporous, but the megaspore is retained and germinates within a specialized sporangium called an ovule. In some forms (*Cycas*, *Ginkgo*), fertilization is still effected by flagellate male gametes, but the only fluid necessary is a small drop, immediately above the archegonia, into which the gametes are released. Other higher archegoniate plants escape even from this requirement. The male gametophyte is filamentous, and, as a consequence of its growing toward the female gametophyte, it liberates the male gametes (which now lack any specialized means of locomotion and are probably moved passively) directly into an archegonium (siphonogamy). In a few allied plants (e.g., *Gnetum*), modifications of the female gametophyte result in the disappearance of the archegonium. Ultimately we arrive at the embryo sac and the finely ordered cytology that is characteristic of the sexual reproduction of the flowering plants (Chapter 9). Comparative morphology and the fossil record indicate that the morphological sequence we have considered here also represents the evolutionary development of sexual reproduction in land plants. Compared with the cytological elegance of fertil-

Table 1.2 Sex expression in plants.*Algae*

Where reproduction is sexual, sex is expressed only in the gametophytic phase. The gametophyte can be either unisexual (as in *Ectocarpus* (p. 86)) or bisexual (as in *Coleochaete* (p. 64)).

Bryophytes

Sex is expressed only in the gametophytic phase. This phase can be either unisexual (as in dioecious species) or bisexual (as in monoecious species). Sex may be expressed differently in different regions of the same gametophyte (as in the moss *Funaria hygrometrica* (p. 130) and many other species).

Tracheophytes

Sex is expressed in the gametophytic phase, either unisexually (as in heterosporous archegoniates) or bisexually (as in homosporous species). Sex may also be expressed in the sporophyte, as in dioecious species of seed plants (e.g., *Taxus baccata* among conifers, and *Lychnis dioica* and many other species of flowering plants). In these plants the female produces only megaspores, and the male only microspores (pollen). Sex may also be expressed differently in different regions of the same sporophyte, as in diclinous species of monoecious flowering plants (p. 285). It is possible that some heterosporous pteridophytes, now extinct, had separate male and female sporophytes (p. 147).

Table 1.3 The plant kingdom: phototrophs containing chlorophyll and evolving oxygen during photosynthesis.*Subkingdom Algae*

Predominantly plants of aquatic environments, or persistently damp situations exposed to saturated atmospheres. Unicellular; colonial or multicellular; the multicellular forms lacking a well-developed vascular system. Reproductive mechanisms relatively unspecialized. Complex and thickened walls associated only with resting cells. (Chapters 2, 3 and 4)

Subkingdom Embryophyta

Division Bryophyta

Terrestrial or epiphytic, some aquatic. The sporophytic phase normally determinate and partly dependent upon the gametophyte. Multicellular; external surfaces covered with a cuticle, but that of the gametophyte relatively permeable. Vascular systems, if present, not highly differentiated. Sexual reproduction dependent on presence of water: Spores with exine but only in a few groups heavily thickened and ornamented. (Chapter 5)

Division Tracheophyta

Almost entirely confined to land, a few marine ("sea grasses"), aquatic forms rarely completing their life cycle in a submerged state. The gametophytic phase relatively small or rudimentary, the sporophyte not dependent upon it. Sporophyte often of indefinite growth, regularly provided with a cuticle, normally impermeable, and almost always with stomata and internal air spaces. Well-defined vascular systems consisting of xylem and phloem. Reproductive regions often with elaborate morphology. Spores usually with a well-developed and acetolysis-resistant wall. Fusion of male and female gametes only in more primitive forms dependent on extraneous water: (Chapters 6, 7, 8 and 9)

ization in an angiosperm, the clumsy spermatozoid of *Cycas* is thus not only barbarous, but also primitive.

Following the evolution of heterospory, there was also a clear tendency for sex expression to

appear in the sporophyte, specialized organs of sporophytic structure (such as the male stamen and the female ovule) housing the sites yielding the initial cells of the succeeding gametophytic generation (Table 1.2).

Classification of the chlorophyllous phototrophs

A classification provides the shelving on which knowledge of the plant kingdom can be arranged in an orderly fashion. The ideal is a classification which arranges plants according to their level of organization and in their natural alliances. In every classification there is an element of subjectivity. Consequently as knowledge expands judgments need to be modified. The primary classification followed in this book is shown in

Table 1.3. The classifications of the algal subkingdom and of the embryophyte divisions will be found subsequently at the beginnings of Chapters 2, 5 and 6. The aim throughout is to present a general view of the principal kinds of organization encountered in the plant kingdom. Although the approach is systematic, a purely systematic treatment is not attempted and would be inappropriate. The lower plants receive proportionately greater attention. The fossil evidence indicates that they retain features present at crucial stages in plant evolution. Familiarity with them is essential for an understanding of today's diversity.

The subkingdom Algae: Part I

Biological features of algae

The simplest phototroph imaginable is a single cell floating in a liquid medium, synthesizing its own sugar, and reproducing at intervals by binary fission. Such organisms do in fact exist in both fresh and salt waters. Examples are provided by the cyanophyte *Synechococcus* (p. 28) and the minute marine *Micromonas* (Fig. 1.6).

These organisms are examples of algae, the group of plants showing the greatest diversity of any major division of the plant kingdom. They range from minute, free-floating, unicellular forms (represented by both prokaryotes and eukaryotes) to large plants, exclusively marine, several meters in length. Many of the smaller algae form a component of *plankton*, the communities of minute plants and animals which float at or near the surface of fresh waters and oceans. Algae are responsible for a large part of the photosynthesis in the biosphere, the productivity of some coastal communities in the surf of warm seas exceeding that of the tropical rain forest. Much of the carbon so fixed enters the food chain of the aquatic heterotrophs.

Despite the enormous range in size, the algae remain comparatively simple in organization. In the smaller multicellular species (e.g., *Merismopedia*, Fig. 2.6; *Pediastrum*, Fig. 3.8) the cells resemble each other in appearance and function, and they can be regarded as forming little more than an aggregate of independent units. In the larger, however, there is morphological and cellular differentiation, although usually less exten-

sive than in most land plants. The few heterotrophic forms, mostly small, are regarded as derived. Some, even the smallest (e.g., the dinoflagellates, p. 95), appear to be composite organisms, incorporating a photosynthesizing endosymbiont.

Many algae are fully immersed and firmly attached to the substratum. Together with a few vascular plants these constitute the *benthos*, and contrast with the floating plankton. The attachment may be by a disk-like holdfast, which forms a firm union with the surface of a rock or stone, or branched, penetrating soft material such as muds. Branched root-like attachments (as in the Charales) may participate in the absorption of minerals, but any resemblance to the root system of higher plants is distant.

The largest algae are found only in the sea. The restriction of these forms to a marine environment is perhaps accounted for by the relative impermanence of inland waters in geological time, and the consequent limiting of the opportunity for the evolution of similar complexity in these situations. Although marine algae are sometimes able to withstand inundation in fresh water (e.g., *Fucus*, p. 90), and occasionally may even become adapted to permanently low salinity (e.g., *Ulva* and *Enteromorpha*, p. 54), they do not normally survive indefinitely or grow in these conditions. Presumably, fresh waters are unable to supply minerals at a rate adequate for their metabolism. A large alga in European seas is *Laminaria* (Fig. 4.16), some species of which may reach 4 m (13 ft, 4 in.) in length. Off the west coast of North America are found the gigantic

Nereocystis and *Macrocystis*, with thalli commonly extending 50 m (165 ft) or more. Maintaining the integrity of a thallus of this size raises substantial mechanical problems. Although the sea provides considerable supporting upthrust, currents and turbulence cause more sustained tensions and pressures than similar movements in a gaseous medium. The toughness and hard rubbery resistance to any kind of distortion found in the larger algae are thus necessary qualities for survival in the oceans. These attributes arise principally from the general properties of the cell walls and of the surface, and not from any specialized strengthening elements.

The biophysical features of photosynthesis in the algae are the same as those in land plants, but the C₄ pathway of carbon dioxide assimilation (p. 6) characteristic of some land plants seems not to be represented (with the possible exception of the coenocytic green alga *Udotea*, p. 58). As would be expected of a group exploiting the aquatic habitat, many of the secondary products found in the algae have distinctive biochemical characteristics. Many algae, for example, accumulate fats and oils rather than starch, and others polyhydric alcohols. The cell walls of the eukaryotic algae often contain the polysaccharides mannan and xylan in microfibrillar form in addition to cellulose. The nitrogenous polysaccharide chitin is found as an outer layer of the wall in *Cladophora prolifera* and possibly in *Oedogonium*. Pectin, a polymer based on galacturonic acid, is a common component of algal cell walls, sometimes forming a distinct outer sheath (e.g., *Scenedesmus*, Fig. 3.7). Colloids such as fucin and fucoidin, unknown outside the algae, occur in the amorphous matrices of the walls of brown algae. Alginic acid, which occurs in quantity in the middle lamellae and primary walls of several brown algae, is extracted commercially and finds a wide range of uses as an emulsifier in industry, and is a component of the familiar “instant puddings”. Complex mucilaginous polysaccharides rich in galactan sulfates are characteristic of the red algae. Dimethyl sulfur compounds assist osmoregulation in marine phytoplankton. Gaseous derivatives of these escape and contribute to the sulfur content of the atmosphere. Oxidation of these derivatives leads to sulfur or sulfate particles in the air above oceans.

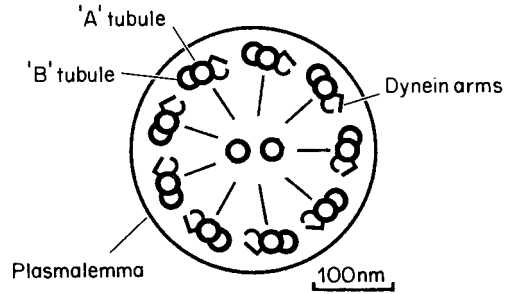

Figure 2.1 Diagram of transverse section of a eukaryotic flagellum viewed from the base. The “spokes”, radiating from the center to the peripheral doublets, are usually recognizable. Sometimes an ill-defined sheath is present around the central pair of tubules.

These particles are believed to give rise to aerosols which promote cloud formation. This in turn leads to cooling of the surface. Evidence is accumulating that the metabolic effects of oceanic phytoplankton have a significant rôle in determining climate.

Many unicellular algae, occurring both singly and in colonies, and the unicellular reproductive cells of more complex algae are motile. In some prokaryotic forms (e.g., cyanophytes, p. 26) and in some eukaryotic ones (e.g., diatoms, p. 82), movement is brought about by directed jets of mucilage. The motility of many eukaryotes however depends upon the presence of flagella. An unexpected and remarkable discovery of electron microscopy was that all flagella produced by eukaryotic organisms have a common basic structure, providing a characteristic picture in transverse section (Fig. 2.1). Nine pairs of microtubules, each pair oriented tangentially, are equally spaced around the periphery of the flagellum. Although the microtubules of each pair are similar in diameter (18–25 nm), they differ in profile. Viewed from the base of the flagellum outward, the microtubule on the right (the “A” tubule) usually appears circular in outline, whereas that of the “B” tubule on the left is not completely so. The portion of the “B” tubule shared with the “A” tubule commonly follows the curvature of the latter. In addition to the peripheral microtubules two free microtubules usually lie symmetrically at the center. These are often slightly wider than the peripheral tubules. Usually, but not always in plant flagella,

two short arms can be made out on the “A” tubule. These consist of a special protein, dynein, an ATPase.

The microtubular system of the flagellum constitutes the *axoneme*. The microtubules of axonemes appear to be quite similar to others in the cell, but they are not so sensitive to colchicine. In some instances flagellogenesis may even continue in the presence of this anti-microtubular drug. Movement of the axoneme is probably caused by the paired microtubules sliding over one another. The mechanism is not however entirely understood. More detailed information will probably come from the study of mutants in which the structure of flagella is in some way defective.

Formerly two classes of flagella were recognized, “whiplash” considered to be smooth, and “Flimmer” furnished with rows of minute hairs (*mastigonemes*). It now seems doubtful whether algal flagella are ever entirely smooth, but appendages are certainly much more conspicuous in some groups than in others. Appendages other than hairs are also known. The single flagellum of *Micromonas*, for example, is covered with minute scales, and that of the related *Pyramimonas* with minute scales of two distinct kinds. The electron microscope has shown that in many instances these scales are assembled in Golgi bodies and transported to the surface in vesicles.

The nature of the surface, and other features of the flagella such as their number, arrangement, and method and kind of insertion, have attracted considerable interest, those of the biflagellate unicells of the Chlorophyta having received closest attention (Fig. 2.2). Here the flagella are anchored by four “roots”, two consisting of a bundle of four microtubules, and two of two microtubules. Viewed from above the bundles reveal a cruciate arrangement. Often the insertions of the flagella (basal bodies) do not lie in the same plane, one being shifted slightly in relation to the other (Fig. 2.2). If the shifting is in a clockwise direction (as in *Chlamydomonas*) the arrangement is said to be “1 o'clock–7 o'clock”, and if the converse “11 o'clock–5 o'clock”. The latter is not found in any free-living unicellular forms, but occurs in the gametes of a number of Ulvophyceae. A coplanar arrangement of the flagellar bases is comparatively rare, but is found in zoospores and gametes

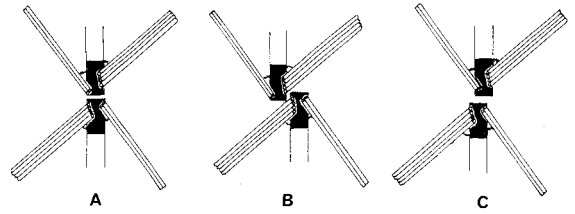

Figure 2.2 Positional relationships of the basal bodies (black) and flagellar roots in biflagellate cells of the green algae (Chlorophyceae), viewed from the anterior end of the cell. (A) The basal bodies lie in the same plane (possibly an ancestral arrangement). (B) The basal bodies are shifted in an anticlockwise direction relative to each other (positions “11 o'clock–5 o'clock”). (C) The shifting is in a clockwise direction (positions “1 o'clock–7 o'clock”). Comparable relationships are found in quadriflagellate cells. (From Van den Hoek, Mann and Jahns. 1995. *Algae: An Introduction to Phycology*. Cambridge University Press, Cambridge.)

of the Chlorococcales. Flagella features have given useful indications of relationships within the Chlorophyta.

The basal bodies of the Chlorophyta are also associated with strands of contractile protein. These strands are termed *rhizoplasts* and the constituent protein *centrin*. The contraction and relaxation of this protein depend upon the balance of Ca^{2+} and ATP, and its activity contributes to the motions of the flagella. The rhizoplasts run down into the cell and terminate adjacent to the nucleus or chloroplast.

Some motile gametes and zoospores within the Chlorophyta have a symmetry different from that of *Chlamydomonas*. They are unilateral and a single microtubular ribbon descends from the basal bodies into the body of the cell. At the anterior of the ribbon, beneath the basal bodies, is a conspicuous multilayered structure. This is very similar to the corresponding structure beneath the basal bodies in the motile male gametes of the archegoniate land plants. A splendid example is seen in the alga *Coleochaete* (Fig. 3.35), an algal form which has several other features of significance in relation to the origin of the earliest land plants in the Silurian (see Chapters 3, 5 and 6).

Attention has also been paid to the manner of cell division in the algae, again principally in the green algae. The nuclear envelope may remain almost intact at the time of division, and the

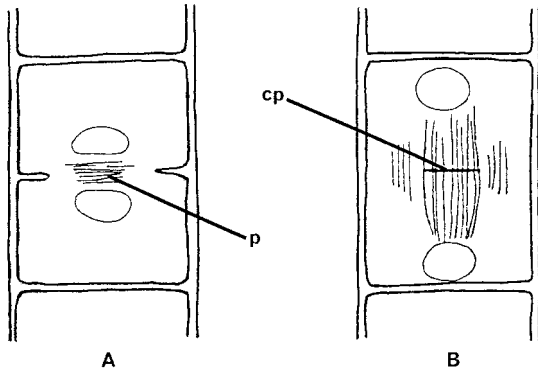

Figure 2.3 Extreme forms of cytokinesis in green algae (in longitudinal section, diagrammatic). (A) Mitotic spindle transient, nuclear envelope remaining largely intact throughout. Division is completed by ingrowths of the wall directed toward a transverse equatorial array of microtubules (phycoplast, p). (B) Spindle persists until telophase. Transversely oriented microtubules at equator absent, cell plate (cp) forms within a vesicular phragmoplast transverse to the axis of the spindle, and extends laterally, completing the dividing wall.

spindle transient (as in *Chlamydomonas*) or persisting until telophase. Cytokinesis may be brought about by wall ingrowths penetrating a transverse array of microtubules (termed a *phycoplast*) (Fig. 2.3A), or, more rarely, be initiated by a cell plate formed within a phragmoplast at the equator of a more persistent spindle, as in all land plants (Fig. 2.3B). Patterns of cytokinesis intermediate between these two extremes are also encountered. Significantly, the phragmoplast type of division has been observed only in those algae (members of the Charophyceae) thought to be closest to those from which the land plants arose.

Amongst other eukaryotic algae, the biflagellate heterokonts (Table 2.1) form a natural group. The two flagella differ in length, the nature of their ornamentation, and their orientation. The longer flagellum is of the “Flimmer” kind and is directed forward. The shorter flagellum is smooth and is directed backward along the cell. The group also has ultrastructural features in common, such as the manner in which the plastid is enclosed in a fold of endoplasmic reticulum (e.g., Fig. 4.27). The Bacillariophyta (diatoms) (p. 80) are also included in the heterokont algae: although the male gamete (the only flagellate stage in the life history) has only a single flagellum, it has the

Flimmer structure typical of the heterokonts, and the characteristic chloroplast endoplasmic reticulum is also present. The Rhodophyta are outstanding in having no flagellate forms amongst living representatives. A few unicellular forms belonging to the Haptophyta (p. 93) have, in addition to two flagella, a third flagellum-like organ. The structure of this is much simpler and less regular than that of the “9 + 2” flagellum.

The chloroplasts of algae take a variety of shapes, for example plate-like in *Mougeotia* (p. 62), stellate in desmids (p. 62) and some red algae, as girdles close to the cell wall (*Ulothrix*, p. 52), in the form of a spiral ribbon (*Spirogyra*, p. 63), cup-shaped in *Chlamydomonas* (p. 40) and reticulate (as in many Chlorococcales). Discoid chloroplasts, the form common in land plants, are found in a few red algae and in *Chara* (p. 66), but are generally rare. Although irregular stacking of thylakoids commonly occurs in chloroplasts of chlorophylls “a + b” algae (Table 2.1) (e.g., *Chlamydomonas*), the distinct grana characteristic of land plants are absent. A prominent feature of many algal chloroplasts is the *pyrenoid*, a proteinaceous body and the site of the enzyme RUBISCO (p. 2). In land plants RUBISCO is distributed in the stroma of the plastid. The pyrenoid may also be the site of starch formation, but not in the red algae (p. 30).

There is no evidence that the major groups of algae have any close relationship with each other. Nevertheless, there are sufficient morphological, physiological and ecological similarities between these plants to make the term “alga” a useful one. Study of the structure and reproduction of the algae reveals a number of ways in which these simple phototrophs have increased their morphological and reproductive complexity. We shall in the main be concerned with the illustration and discussion of these trends, and we shall not attempt a complete taxonomic or morphological survey of any group. The general classification of the algae followed in this work, based upon the nature of the chlorophylls present in the photosynthetic membranes, is shown in Table 2.1.

Table 2.1 | Classification of the subkingdom Algae.

Division	Class/subclass	Order
	Algae containing wholly or predominantly chlorophyll <i>a</i>	
CYANOPHYTA (Cyanobacteria)	Cyanophyceae	Chroococcales Nostocales Stigonematales
GLAUCOPHYTA RHODOPHYTA	Rhodophyceae Bangiophycidae Florideophycidae	
	Algae containing chlorophylls <i>a</i> and <i>b</i>	
PROCHLOROPHYTA CHLORACHNIOPHYTA CHLOROPHYTA	Prasinophyceae	Pedinomonadales Pyraminodales Pterospermatales Volvocales Tetrasporales Chlorococcales Chlorosphaerales Chaetophorales Oedogoniales Sphaeropleales Ultrichales Ulvales Prasiolales Cladophorales
	Chlorophyceae	Siphonocladales Codiales Caulerpales Dichotomosiphonales Dasycladales Klebsormidiales Mesotaeniales Desmidiales Zygnematales Coleochaetales Charales
	Ulvophyceae	Tetraselmidiales Pleurastrales Trentepohliales
	Charophyceae	Euglenales Eutreptiales
EUGLENOPHYTA	Euglenophyceae	
	Algae containing chlorophylls <i>a</i> and <i>c</i>	
CHRYSOPHYTA XANTHOPHYTA BACILLARIOPHYTA PHAEOPHYTA	Phaeophyceae	Ectocarpales Sphacelariales Cutleriales Laminariales Fucales Dictyotales
HAPTOPHYTA (Prymnesiophyta) DINOPHYTA (Pyrrophyta)	Desmophyceae Dinophyceae	
CRYPTOPHYTA		

Siphonales

Heterokont algae

Algae in which the chlorophyll is wholly or predominantly chlorophyll *a*

These algae, which embrace both prokaryotic and eukaryotic forms, are probably the closest amongst the living algae to the original cellular phototrophs. They are therefore of particular interest in relation to the origin of plant life.

Prokaryotic forms

Those prokaryotic forms which contain solely chlorophyll *a* comprise the well-characterized division Cyanophyta ("blue-green algae"). Many exist as single cells and are representative of the simplest phototrophs. In others the cells are aggregated either loosely or into groups, each with a distinctive morphology (e.g., *Gloeotrichia*, Fig. 2.11). Filamentous forms also occur, and a few attain a multiseriate and pseudoparenchymatous level of organization (*Stigonema*, p. 26).

CYANOPHYTA (CYANOBACTERIA)

Habitat Water, swamps, soil, occasionally endolithic.

Pigments Chlorophyll *a*; β -carotene; myxoxanthin, zeaxanthin; biliproteins (allophycocyanin, phycocyanin and phycoerythrin).

Food reserves Cyanophyceean starch (similar to glycogen), polyphosphate granules (volutin), cyanophycin (a polymer of arginine and aspartic acid).

Cell wall components Murein, hemicelluloses.

Reproduction Asexual. Genetic recombination observed, but mechanism not clearly established.

Growth forms Unicellular, cellular aggregates, filamentous, a few pseudoparenchymatous.

Cytology

The cells, rarely exceeding 10 μm in diameter, are not unlike those of bacteria. Indeed, despite the presence of chlorophyll *a* and the possession of oxygenic photosynthesis, the cyanophytes are often classified with the bacteria ("Cyanobacteria") instead of with the algae. The resemblance is enhanced by the presence of the peptidoglycan murein in the cell walls, their

being subject to attack by viruses similar to the bacteriophages, and the bearing by some of filamentous appendages (fimbriae) otherwise found only in Gram-negative bacteria. Some cyanophytes, if present in anaerobic situations rich in sulfide, are able to use hydrogen sulfide as an electron donor, producing sulfur or thiosulfate as a by-product. A similar kind of photosynthesis is found in certain bacteria. Another bacterial feature is that some cyanophytes (e.g., species of *Oscillatoria* and the related *Microcoleus*) are able, in association with various bacteria, to metabolize heavy hydrocarbons. Mats formed by these organisms find a practical use in cleaning up massive oil spills (as followed the military operations in the deserts of Kuwait).

Under the light microscope, partly because of the small size of the cells, the photosynthetic pigments appear dispersed in the cytoplasm. The electron microscope reveals that this is an erroneous impression, and that the cells contain the same kind of photosynthetic membrane as that present in higher plants. The thylakoids, which arise as, and may remain, invaginations of the plasmalemma, form either loose stacks parallel to the longitudinal axis of the cell, or a number of concentric whorls. Less commonly they form a three-dimensional reticulum, and in older cells have been seen to aggregate into a crystalline body about 0.3 μm in diameter closely resembling the prolamellar bodies of etioplasts of higher plants. Skeins of DNA, together forming the nucleoid, may be scattered between the thylakoids. Blue-green algae from hot springs have yielded the first pure preparations of the chlorophyll *a* reaction center at which the light energy is transformed into chemical (photosystem I).

Also seen in the electron microscope are small particles about 30 nm in diameter, lying on the outer surfaces of the thylakoids. These are the site of the biliprotein pigments (*phycobilisomes*). They trap the light energy which is subsequently utilized in photosystem II, that part of photosynthesis which leads to the evolution of oxygen. Scattered amongst the thylakoids and skeins of DNA are polyhedral bodies (*carboxysomes*). These are the sites of the enzyme RUBISCO (p. 2).

Elsewhere in the cell are found clusters of minute cylinders, each bounded by a sheet con-

sisting solely of protein, and containing gas (*gas vesicles*). These regulate buoyancy, and collapse if the cells are subjected to sudden mechanical shock. Vacuoles similar to those of eukaryotic cells are absent.

In many filamentous species the chains of cells are interrupted by occasional conspicuously larger cells called *heterocysts* (Fig. 2.4). There are often indications of regularity in their spacing (in the filamentous *Anabaena*, for example, about every tenth cell becomes a heterocyst). The mechanism controlling their formation is not wholly known, but in *Anabaena* a gene has been detected which contributes to the spacing pattern. This gene codes for a small peptide which prevents the differentiation of a heterocyst between two existing heterocysts, a kind of control which is more familiar in eukaryotic organisms. The heterocysts contain chlorophyll *a* and some other pigments but are altogether paler, and by contrast may appear empty. Electron microscopy reveals that they contain an elaborate and often reticulate membrane system. The wall of a heterocyst is conspicuously thickened except for a pore at one or both poles. At these sites its protoplast is separated from those of its neighbors solely by a thin septum, in which fine channels (microplasmodesmata) can sometimes be discerned.

Heterocysts are the sites of fixation of atmospheric nitrogen. The enzyme responsible, nitrogenase, is irreversibly inactivated in aerobic conditions. It is significant that the heterocysts lack photosystem II and therefore generate no intracellular oxygen. Indeed, their frequently elaborate membrane systems may indicate considerable respiratory activity. This would in turn promote an anaerobic environment within the cells, which the thickened walls (Fig. 2.4) may help to maintain. Those species able to fix nitrogen without heterocysts can usually do so only at very low oxygen tensions. An exception is the filamentous *Trichodesmium*, which can carry on photosynthesis and fix nitrogen at the same time. It is thought that here photosynthetic and nitrogen-fixing cells, distinguishable only in function, may be differentiated along individual filaments. Circadian rhythms have also been detected in cyanophytes (e.g., *Synechococcus*). Such biological clocks (which are probably similar in principle to

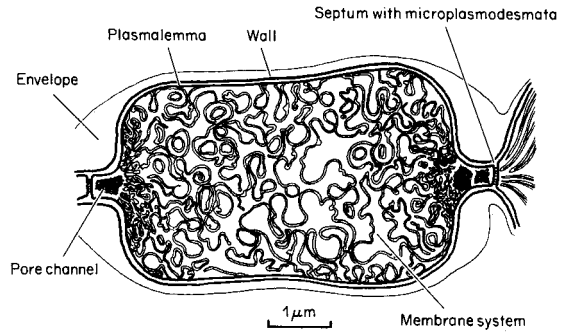

Figure 2.4 *Anabaena*. Longitudinal section of a heterocyst. (After Fay, in Carr and Whitton, 1973. *The Biology of Blue-Green Algae*. Blackwell Scientific Publications, Oxford.)

those in eukaryotic cells, but possibly involve different proteins) may also serve, by modulating gene activity, to separate in time photosynthesis (evolving oxygen) from nitrogen fixation, so preventing destructive interference of the two systems.

In a few instances heterocysts have been observed to regain pigmentation and then to germinate. On these grounds some have considered them to be vestigial reproductive cells. In one species of *Anabaena*, however, differentiation of the heterocyst has been found to involve deletions in the DNA. If this is a general phenomenon and heterocysts are truly capable of regenerating the whole organism, these deletions are presumably reversible. The respiration of cyanophytes tends to be depressed by light, and with mat-forming species bright light has also been found to inhibit the synthesis of DNA. This may serve to reduce the chance of damage to the DNA by UV radiation, and be a relic of a protective mechanism dating from Precambrian times when UV radiation reaching the Earth's surface, in the absence of an ozone shield, would have been a far greater hazard.

The cell walls of the Cyanophyta contain a layer of the peptidoglycan murein adjacent to the plasmalemma. The walls are thus chemically and structurally similar to those of Gram-negative bacteria, and their formation is similarly disorganized by penicillin. The presence of murein also accounts for the dissolution of the wall, as those of bacteria, by lysozyme. The outer part of the wall is commonly a distinct layered sheath, sometimes pigmented, and frequently consisting largely of

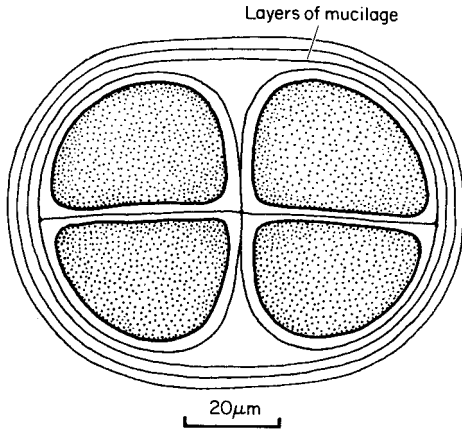

Figure 2.5 *Chroococcus*. Colony held together by successive sheets of mucilage.

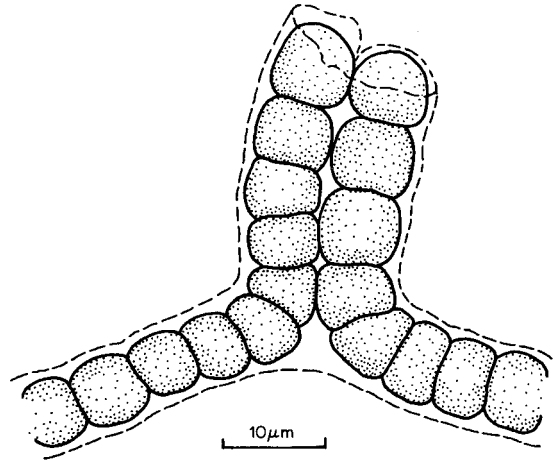

Figure 2.7 *Tolypothrix* showing “branching”.

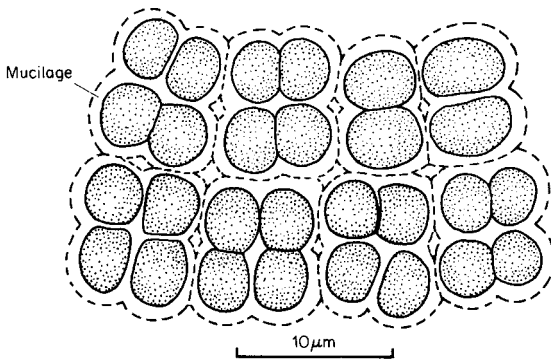

Figure 2.6 *Merismopedia*.

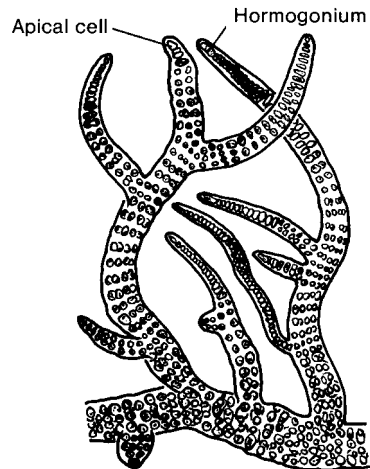

Figure 2.8 *Stigonema*. Part of plant showing the pseudoparenchymatous thallus. A segmenting apical cell can be distinguished at the tips of the branches. Hormogonia consisting of two or a few cells are formed at the ends of some of the branches. (After Frémy, redrawn from Fritsch. 1945. *The Structure and Reproduction of the Algae*, vol. 2. Cambridge University Press, Cambridge.)

gelatinous or slimy hemicelluloses. The creeping movements of some species (reaching up to $4\mu\text{ms}^{-1}$) are caused by localized excretion of mucilage through fine pores, about 4 nm in diameter, in the wall. Some strains of *Synechococcus* display a considerably greater motility, reaching up to $25\mu\text{ms}^{-1}$. No motile apparatus has been detected. It is thought that compression waves, passing over the surface of the cell with a frequency of about 1000sec^{-1} , produce a propelling force in an aqueous environment.

The gelatinous material of the outer wall frequently holds cell colonies together (Figs. 2.5 and 2.6). The morphological integrity of the more strikingly filamentous forms often depends upon the cells being held in linear sequence by the toughness of the sheath. The continuity of the

sheath is broken at points of branching either “false”, characteristic of *Tolypothrix* (Fig. 2.7), or “true”, as seen in the filamentous *Mastigocladus* and the pseudoparenchymatous *Stigonema* (Fig. 2.8).

Distribution

The Cyanophyta are widely distributed, occurring in both soil and water, though rarely at a pH below

4.0. Some are marine (e.g., *Trichodesmium*, globally distributed and one of the organisms responsible for the color of the Red Sea). Others are found under such extreme conditions as snowfields and hot springs (where they can survive temperatures of up to 85°C/185°F), and beneath the eroded surfaces of rocks in Antarctic deserts. Some species are remarkably resistant to desiccation: a culture of *Nostoc*, for example, has been obtained from the dry soil at the base of a herbarium specimen 87 years old. A protein providing protection against desiccation damage, immunologically related to the “dehydrins” widely distributed in the seeds of higher plants, has been detected in a number of cyanophytes. Tolerance of desiccation, and an ability to withstand without damage cycles of freezing and thawing, probably account for the dominance of cyanophytes in polar aquatic ecosystems.

Many species occur as slimes on rocks, damp soils and tree trunks, and as scums on stagnant water. Some live as endosymbionts in the protoplasts of colorless flagellates and amoebae. The “cyanelles” of the flagellate *Cyanophora* and the non-motile unicellular *Glaucocystis* (Fig. 2.9) (both of which are currently placed in a separate division, Glaucophyta) probably arose from endosymbionts of this kind. The boundary of the cyanelle appears to retain a peptidoglycan. Cyanelles may divide after being expressed from the host cell, but it has not been possible to culture them indefinitely in isolation. The DNA of cyanelles contains less genetic information than that of free-living species, so there appears to have been some loss in response to the endosymbiotic habit. Other species with (so far as known) wholly undiminished genomes form colonies in the tissues of higher plants (e.g., the presence of *Anabaena* in the fern *Azolla* (p. 212) and associated with the roots of the gymnosperm *Cycas* (p. 245)). Cyanophytes are also components of some lichens. One such lichen, *Winfrenatia*, has been identified in the Rhynie Chert, a siliceous formation of Lower Devonian age in Scotland. These symbiotic associations are probably related to the ability of many species to both photosynthesize and fix atmospheric nitrogen, with the subsequent release of valuable metabolites to the host. The fertility of many swampy tropical soils (e.g., rice *padi*) is

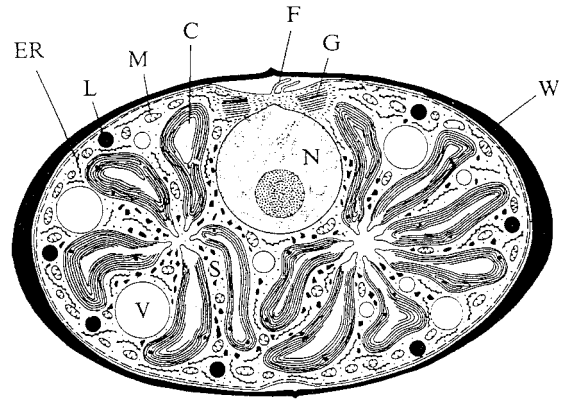

Figure 2.9 *Glaucocystis*. Diagrammatic representation of the ultrastructure of the cell sectioned in the median plane. The ellipsoidal cell is symmetrical about a plane transverse to the longer axis. The anterior pole is marked by two rudimentary flagella (F) which do not penetrate the cell wall (W). The nucleus (N) lies to one side of the cell, and a ring of Golgi bodies (G) lies beneath the basal bodies of the flagella. A stellate group of cyanelles (C) is situated on each side of the nucleus. Granules of starch (S) are scattered in the cytoplasm and less frequently lipid droplets (L). Mitochondria (M), endoplasmic reticulum (ER) and vacuoles (V) are also present. The major diameter of the cell is of the order of 30 μm . (After Schnepf, Koch and Deichgräber. 1966. *Archiv für Mikrobiologie* 55.)

dependent upon nitrogen fixation by cyanophytes. Conversely, in temperate regions they often contaminate fresh water, particularly where these become enriched by mineral nutrients from agricultural drainage (eutrophication). Some cyanophytes which form “blooms” in these situations release toxic substances (often neurotoxins) into the water which can endanger the lives of cattle and humans. There is evidence from Southeast Asia that domestic supplies drawn from sources which have become contaminated by cyanophytes (particularly the coccoid *Microcystis*) promote the formation of tumors in the liver. Chlorination of the water may, by killing the algae, cause the release of additional endotoxins into the water and increase its toxicity. The toxins affecting the liver are principally small cyclic peptides which interfere with the function of phosphatase enzymes.

A number of species growing in mineral-rich waters secrete calcium carbonate or silica, and so build up laminated rocks (*stromatolites*). Living

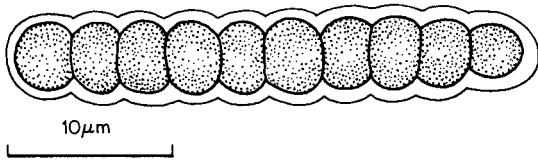

Figure 2.10 *Nostoc*, hormogonium.

examples are found in Western Australia and North America, and fossil stromatolites occur as far back as the Precambrian. However, since similar laminated structures can arise from purely chemical causes, the biological significance of fossil stromatolites must be assessed with caution.

Reproduction

Although genetic recombination has been reported, the observed reproduction of the Cyanophyta is entirely asexual, in its simplest form involving nothing more than cell division. This, correlated with the absence of distinct nuclei, is not associated with the formation of any recognizable mitotic figure or chromosomes. In some species, mainly those that are unicellular, the cell enlarges, and the protoplast meanwhile divides to form many naked daughter cells termed *baeocytes*. When these are eventually released they develop a cell wall and become new individuals. In filamentous species reproduction is frequently by simple fragmentation. This is rarely indiscriminate, but involves the filament becoming interrupted at intervals by dead cells (*necridia*). The necridia ultimately rupture and the intervening fragments of filament, some 5–15 cells long and now termed *hormogonia* (Fig. 2.10), are liberated. They often show motility before developing into a new individual. Many, but not all, Cyanophyta have been observed to produce *akinetes* in unfavorable conditions. These develop from single cells. There is considerable increase in size, and an accumulation of cyanophycin and polysaccharide. Photosynthetic activity declines and ultimately the envelope becomes massive. Akinetes probably play an important rôle in the preservation of species. They appear capable of surviving prolonged deposition in aseptic mud, and also desiccation. Germination takes place rapidly in favorable conditions. Reserve materials are cata-

bolized, thylakoids are regenerated and cell division begins. Local dissolution of the envelope releases the new individual.

A form of alternation of generations is found in some Cyanophyta. In *Nostoc*, for example, a heterocystous cycle can be made to alternate with an akinete-producing cycle, light being essential for the switch to the latter.

Representative species

The taxonomy of the cyanophytes is frequently revised as information becomes available from sequence studies of their DNA and RNA. Four principal orders can be recognized, namely the Chroococcales, mainly single or aggregated spherical cells, the Pleurocapsales, consisting of short stubby filaments, sometimes becoming pseudoparenchymatous and showing heterostichy, and the clearly filamentous Nostocales and Stigonematales.

Although containing the simplest blue-green algae, some of the **Chroococcales** are nevertheless colonial forms with a regular and conspicuous symmetry. The minute cells of *Synechococcus* (about 20 μm in diameter) usually occur singly or (immediately following division) in pairs, but in *Chroococcus* (Fig. 2.5) more usually, and always in the similar *Gloeocapsa*, the cells remain held together after division in a mucilaginous matrix. These aggregates of indefinite size and shape are referred to as *palmelloid* forms. In *Merismopedia* (Fig. 2.6) the cells are arranged in regular rows to form a plate, and in *Coelosphaerium* a hollow sphere. Other geometric arrangements are characteristic of further genera in this order. Although the cells in these colonial forms appear to be all of similar status and function, there is evidence of polarity, since in vegetative reproduction divisions appear to take place more readily in certain directions than in others.

The **Pleurocapsales** contain the interesting *Hyella*, a widespread heterotrichous genus found on calcareous substrates. It occurs, for example, on mollusk shells, forming a pseudoparenchymatous growth on the surface which sends rhizoid-like filaments down into the substance of the shell. Remains of an endolithic cyanophyte, which appears to be very similar to *Hyella*, have been described from late Precambrian

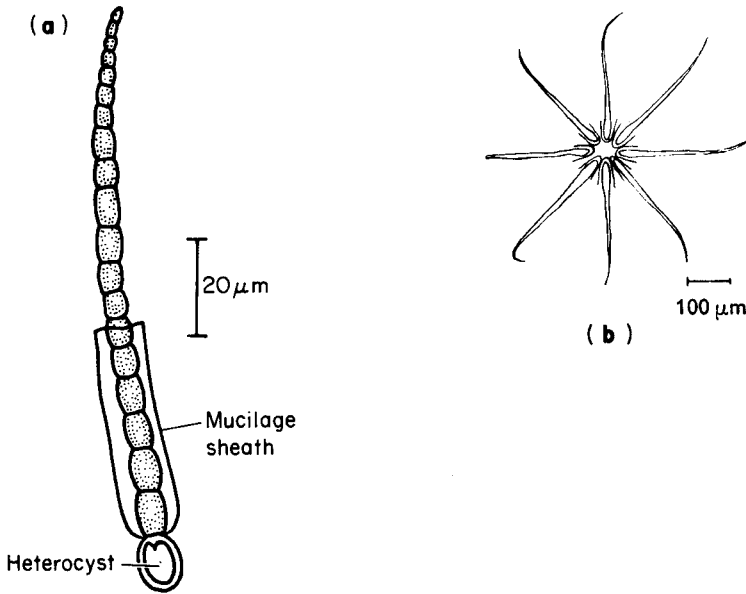

Figure 2.11 *Gloeotrichia*. (a) Single trichome with basal heterocyst. (b) Star-shaped cluster of trichomes.

some have been seen in dividing proplastids in the egg cells of ferns.

The filaments of *Trichodesmium* form fusiform or tufted colonies. There are about 100 cells in each filament (trichome), each cell 5–15 μm in diameter and up to 50 mm in length. Gas vesicles are conspicuous and provide for buoyant colonies.

Nostoc (Fig. 2.12) is a prominent heterocystous form. *Nostoc commune* is common on damp soil. Divisions occur spo-

radically along the filaments resulting in spherical masses of intertwined threads embedded in gelatinous mucilage, the whole often reaching 2 cm (0.75 in.) or more in diameter. *Anabaena* is also filamentous. *Anabaena flosaquae* contains a powerful neuro-muscular poison, and is a frequent component of poisonous blooms.

Clustering of filaments is characteristic of several Nostocales. *Anabaena*, for example, grown in an agitated medium is uniformly dispersed, but if the shaking is stopped the filaments soon group themselves into a few tight bunches. This is probably a consequence of the chance cohesion of fila-

deposits in India. The habit of *Hyella* is paralleled by that of some members of the Chaetophorales (p. 48).

The **Nostocales** are filamentous. The trichomes (the chain of cells as distinct from the sheath) range in width from 20 μm to 1 μm. Sometimes the width diminishes progressively along a filament so that it ends in a fine point (e.g., *Gloeotrichia*, Fig. 2.11). The order falls into two groups, namely those species in which heterocysts have never been observed and those in which they are often conspicuous. Examples of the former are *Oscillatoria*, *Spirulina* and *Trichodesmium* (sometimes placed in a separate order Oscillatoriales). The filaments of *Oscillatoria* are straight, and the cells often furnished with numerous gas vesicles. Individual filaments make oscillatory movements caused by change of curvature being propagated along the filament. The source of these movements is unknown. *Spirulina* is a form with a characteristic spiral filament. It forms mats in soda lakes in Central Africa, and is compressed into cakes used as a human food. The cells of *Spirulina* (and some other cyanophytes) have been found to contain proteinaceous tubular elements (*rhapidosomes*), which, although smaller, may play a structural rôle in the cytoplasm analogous to that of microtubules in eukaryotic cells. It is perhaps significant that tubular elements similar to rhapido-

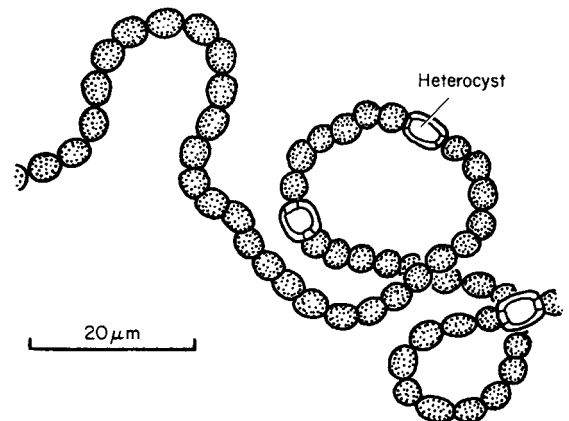

Figure 2.12 *Nostoc*, habit.

ments, followed by the gliding of the filaments along each other within the coalescent mucilage. Sometimes the clustering leads to forms with a distinct morphology. In *Gloeotrichia*, for example, the trichomes radiate from a central plate formed by a coalescence of the larger basal cells (Fig. 2.11b).

The order **Stigonematales** contains the most elaborate Cyanophyta. They are generally heterocystous. Some, such as those submerged on rocks, show *heterotrichy*, producing two kinds of filaments, prostrate and erect. Many members of the order show true branching, the branches being initiated by an oblique division of a cell in the parent filament. In some species of *Stigonema* the prostrate trichomes become pluriseriate and approach a parenchymatous condition (Fig. 2.8). The organization of these forms is no less complex than that of many of the smaller eukaryotic algae.

Eukaryotic forms

The eukaryotic forms provided solely with chlorophyll *a* fall into a circumscribed group called, since many are bright pink in colour, the Rhodophyta ("red algae"). The pigmentation results from the presence of the biliproteins (phycobilins) phycoerythrin and phycocyanin. The chlorophyll *a* is accompanied in a few members by a small amount of an additional chlorophyll (*d*).

The chloroplasts are discoid or lobed, and simple in structure. The thylakoids usually lie parallel, but they are not stacked, and in some forms the biliproteins are present as phycobilisome particles attached to the outside of each pair of thylakoid membranes. These features of the chloroplast of the Rhodophyta are also those of the photosynthetic region of the cells of the Cyanophyta (p. 24). Floridean starch, which is formed in the cytoplasm outside the chloroplasts, is chemically similar to the amylopectin of higher plant starches. Some of the soluble sugar-glycerol storage products are peculiar to the red algae, and have assisted in determining the affinity of less typical forms (e.g., *Cyanidium*). Halogenated secondary metabolic products have been detected in several of the more advanced red algae.

RHODOPHYTA

Habitat Aquatic (mainly marine).

Pigments Chlorophylls *a* and (rarely) *d*; α - and β -

carotene, lutein, zeaxanthin; biliproteins (phycoerythrin, phycocyanin, allophycocyanin).

Food reserves Floridean starch, soluble low molecular weight compounds of sugars and glycerols (e.g., floridoside, digeneaside).

Cell wall components Cellulose, hemicelluloses, sulfated polysaccharides.

Reproduction Asexual and sexual (oogamous).

Growth forms Unicellular, filamentous, pseudo-parenchymatous.

Flagella None.

Although some species frequent rock pools, most Rhodophyta live in the deep waters of warm seas, and are most commonly seen when washed up on beaches. Crustose coralline red algae have been observed from a submersible growing on rocks of sea mounts at depths of 268 m (879 ft) off the Bahamas. Photosynthetically active light at these depths is reduced to about 1/10000 of that available at the surface. This ability to live in the ocean depths depends upon the presence of the biliproteins. Light reaching these regions lies principally at the middle of the visible spectrum, and this coincides with the maximum absorption of phycoerythrin. The energy is immediately transmitted to the chlorophyll which, at these wavelengths, experiences little direct excitation. The bright green color of some freshwater red algae probably results from the photodestruction of phycoerythrin in higher irradiances. An organism of this kind is the unicellular *Cyanidium*, conspicuous in rivulets from hot springs in Yellowstone National Park, USA. The presence of floridoside as a storage product, and ultrastructural similarities, support the placing of this organism with the red algae. It thrives even in waters which are hot to the touch and may be as acid as pH 2. Similarly attributable to the red algae is the minute unicellular *Cyanidioschyzon*, also occurring in hot springs. Each cell, 1–5 μm in diameter, is blue-green in color, and contains a single nucleus, mitochondrion, plastid and microbody. The plastid resembles those of the red algae; chlorophyll *a* is present and also phycocyanin and phycoerythrin in phycobilisomes. The DNA of the nucleus is estimated to amount to 8×10^3 kilobase pairs, the smallest amount known in eukaryotic

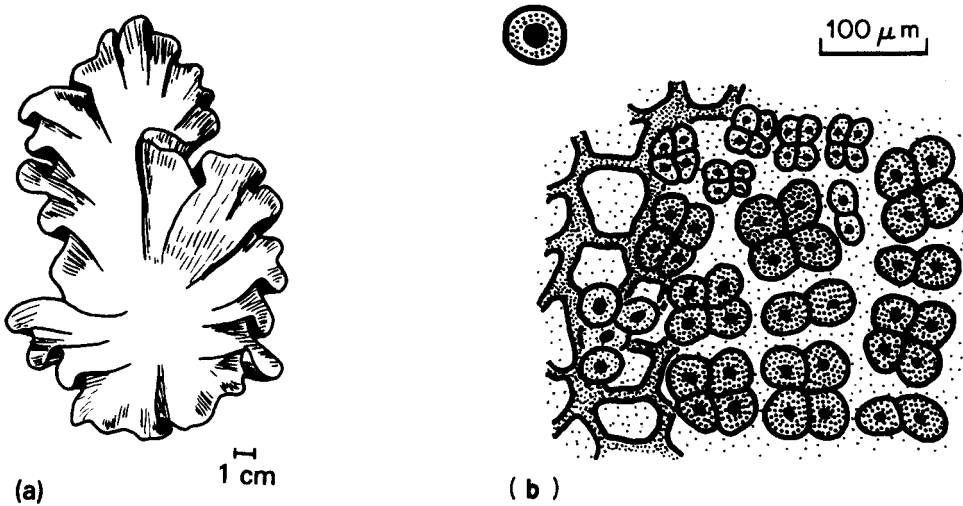

Figure 2.13 *Porphyra*. (a) Habit. (b) Transverse section of portion of thallus producing clusters of monospores. ((b) after Esser. 1976. *Kryptogamen*. Springer-Verlag, Berlin.)

plants. It is about twice that of the plastid in the same cell and also about twice that in the bacterium *Escherichia coli*.

Some species of tropical seas develop a calcareous exoskeleton and contribute to the formation of coral reefs. Miocene limestones (e.g., of Minorca) are sometimes almost entirely of red algal origin. Weathering of the limestone reveals the remains of the original plants. These were more or less spherical and about 5 cm (2 in.) in diameter. The hard ball-like remains are known as “rhodoliths”.

A number of species, often showing reduced pigmentation, may be true parasites on parenchymatous brown algae or on larger members of their own division. Up to one-quarter of the extant species of red algae have been estimated to be wholly or partly parasitic.

A few red algae are of economic importance. The marine *Porphyra* (Fig. 2.13), for example, has long been used in Europe (laver bread) and in the Far East (nori) as a foodstuff. *Chondrus crispus* (p. 33) (carrageen) and *Palmaria* (*Rhodymenia*) (dulse of the Scots and dillisk of the Irish) are similarly used to a lesser extent in Europe. *Gelidium*, particularly from the Pacific, is the principal source of agar. The cell walls of red algae in general are notably mucilaginous.

The Rhodophyta fall into two subclasses, the Bangiophycidae and the Florideophycidae. Unicellular forms are found only in the Bangiophycidae, and this group also displays simpler sexual reproduction. There are also cytological differences, one of the most conspicuous being the presence of well-formed pit connections between the cells in many Florideophycidae. There are no motile forms. Even in sexual reproduction, which is uniformly oogamous, the dispersal of the male gamete is entirely passive.

Bangiophycidae

Apart from the unicellular forms, the simplest Bangiophycidae, mostly epiphytes of other marine algae, are heterotrichous with intercalary growth. *Porphyra* has a sheet-like thallus resembling the chlorophyte *Ulva* (p. 53), but for the most part only one cell thick. It develops from a filament in which the cells divide transversely and longitudinally, the divisions being confined to one plane. The cell walls consist of two parts, an inner consisting of xylan in a microfibrillar form and an outer of mannan; cellulose is absent. The lamina is also provided with a cuticle, accounting for about 2 percent of the thickness of the external walls, and containing about 80 percent protein. A complex population of plasmid-like DNA has been detected in the cytoplasm of *Porphyra*, some strands showing sequence homology with chloroplast, and others with mitochondrial DNA. The significance of these findings is not known.

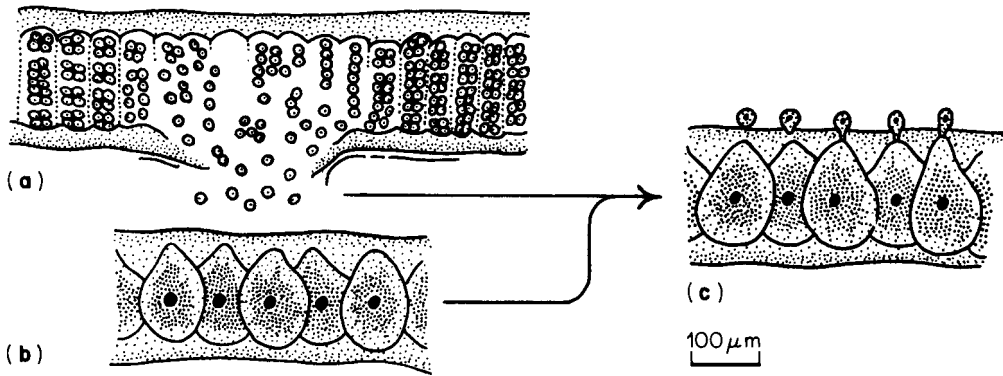

Figure 2.14 *Porphyra*. (a) Portion of thallus producing spermatia. (b) Thallus with oogonia. (c) Spermatia beginning to penetrate oogonia. (All after Esser, 1976. *Kryptogamen*. Springer-Verlag, Berlin.)

Some species of *Bangia* frequent estuaries (notably *B. atropurpurea*) and a few members of the class are found in fresh water. The thallus of *Bangia* consists of multiseriate filaments enclosed in a gelatinous wall. The lower cells produce non-septate rhizoids which attach the tuft to the substratum.

Reproduction

Asexual reproduction is by means of monospores. These are formed following simple division of vegetative cells, one spore being formed in each cell and each spore containing a conspicuous stellate chloroplast. The spores are liberated from the surface or margins of the thallus, sometimes in clusters (Fig. 2.13b). Monospores show bipolar development and regenerate the parent plant.

Details of sexual reproduction in the Bangiophycidae are known for only a few species. The simplest form is shown by *Rhodochaete*, a small filamentous marine epiphyte. Some of the cells produce single male gametes (*spermatia*). Elsewhere in the same thallus a cell otherwise indistinguishable from a vegetative cell acts as an oogonium (usually in the Rhodophyta termed a *carpogonium*), containing a single egg cell. The coming together of the spermatium and carpogonium appears to depend entirely upon water currents. Following fertilization the carpogonium develops into a carposporangium containing a single diploid carpospore. This gives rise to a

diploid plant resembling the haploid gametophyte. This can reproduce by monospores. Meiosis is believed to occur in terminal cells, yielding meiospores which resemble monospores. These regenerate the gametophytic phase. The life history is thus diplohaplontic and isomorphic, and may represent the most primitive form of reproductive cycle in the Rhodophyta.

More is known about sexual reproduction in *Porphyra*. Here a group of cells in the thallus undergoes repeated divisions, each cell yielding 64 or 128 compartments. Each of these liberates a spermatium (Fig. 2.14a). The carpogonia differentiate from vegetative cells and each contains a single egg cell (Fig. 2.14b). The drifting spermatia are trapped and retained by the mucilage surrounding the carpogonia. Fertilization takes place by the protoplast of the spermatium first putting forth a narrow process which penetrates, possibly by means of localized lysis, the membrane of the carpogonium (Fig. 2.14c). The body of the spermatium then passes entirely into the female cell.

After fertilization, the zygote divides and releases several carpospores. The germination of these is unipolar. They give rise to a small filamentous diploid plant most commonly found growing on the inside of oyster and mussel shells. This phase, initially placed in a separate genus *Conchocelis*, differs not only in morphology, but also in the composition of its walls, the microfibrils being of cellulose in place of xylan. Asexual reproduction may occur by means of monospores, but other spores (*conchosporos*), produced in special sporangia, regenerate the more conspicuous gametophyte. Surprisingly, meiosis occurs as the

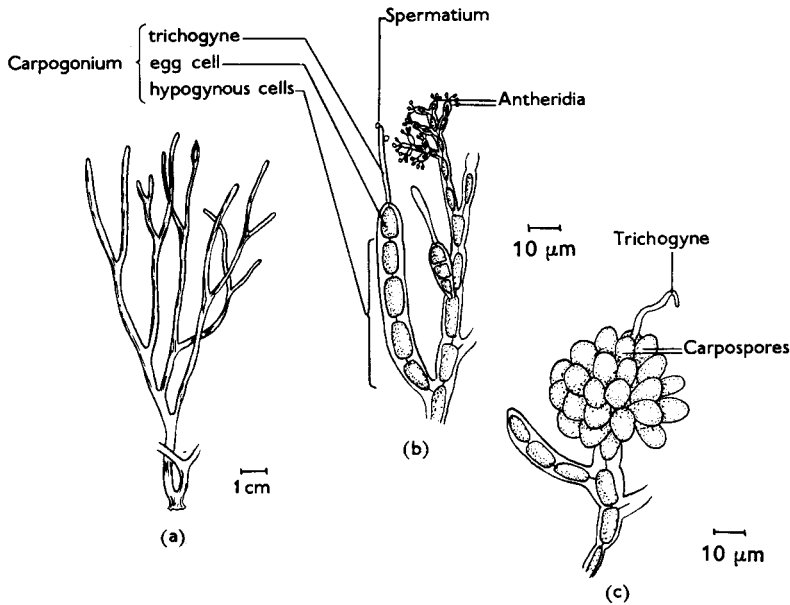

Figure 2.15 *Nemalion multifidum*.
 (a) Habit. (b) Fertile lateral branch.
 (c) Formation of carpospores after fertilization. (After Newton. 1937. *A Handbook of the British Seaweeds*. British Museum, London.)

few members of the class found in fresh water. The vegetative organization is that of a single axis bearing whorls of branches (“uniaxial”). A very similar organization is found in the green alga *Draparnaldiopsis* (p. 48). The filaments are enveloped in copious mucilage; this together with the dark pigmentation of the cells causes colonies of the alga *in situ* in ponds and

conchospore germinates, so that all four meiotic products go to form the resulting gametophyte. Genes segregated at meiosis are represented in different sectors of the mature blade.

The life history of *Bangia* is similar to that of *Porphyra*. There are, however, frequent aberrations in both genera. Apomixis, for example, is well known. Although the life cycle may appear normal, and continue to be moderated by external factors, such as temperature and day length, fertilization is omitted. Also, in some forms, the *Conchocelis* phase may be entirely lacking.

Also placed in the Bangiophycidae is *Porphyridium*, typically consisting of an irregular number of cells embedded in mucilage (the *pal-melloid* condition). The genus is widely distributed, and represented by both aquatic and terrestrial species. Some are capable of a gliding motion on solid surfaces, attributable to the unilateral extrusion of mucilage. The cells contain a single stellate chloroplast and in this respect resemble monospores. Reproduction is entirely asexual, and takes the form of simple cell division.

Florideophycidae

The Florideophycidae are basically filamentous in construction. Growth is frequently from a well-defined apex. Representative of the simpler Florideophycidae is *Batrachospermum*, one of the

streams superficially to resemble masses of frogs' spawn. A more complex form of uniaxial construction is seen in *Polysiphonia*, common in littoral vegetation throughout the world. The thallus, which consists of a central axis bearing freely branching laterals (Fig. 2.17a), shows clearly defined apical growth. This results from a dome-shaped apical cell surmounting a central column of cells which are recognizable throughout the thallus. This axial column is surrounded from well below the summit by numerous columns of other cells produced by oblique divisions in the apical region. The structure thus becomes pseudoparenchymatous, and in parts, especially at the nodes, hardly distinguishable from a truly parenchymatous condition.

In *Nemalion* (Fig. 2.15a), common in the intertidal zones of north temperate shores, the center of the axis is occupied by several filaments ascending in parallel and adhering to each other (“multiaxial” organization). These central filaments are surrounded by an investment of short and freely branched laterals enveloped in mucilage. The branching thallus of *Chondrus crispus*, a common North Atlantic lithophyte, is also multiaxial in structure. The branches are flattened and form a fan-like array. The manner in which in many multiaxial forms the parallel columns of cells diverge at the apex (but do not separate)

gives the impression of a fountain, to which the term “fountain-like growth” (*Springbrunnentypus*) is applied.

The cells of some of the advanced Florideophycidae, such as *Griffithsia*, widely distributed in warmer seas, become multinucleate. Species of Florideophycidae have also yielded evidence of a “wound hormone”, termed *rhodomorphin*, which promotes the healing of damaged filaments. Chemically rhodomorphin proves to be a glycoprotein, a class of proteins attached to sugars, many of which appear to have morphogenetic properties in plants (see, for example, pp. 54, 111).

Reproduction

Asexual reproduction in the Florideophycidae takes place by a variety of spores, including monospores, all non-motile and in many instances known only in conditions of pure culture. A curious feature of the epiphytic *Centroceras* is the development of lateral branches of 4–5 cells which are regularly abscised, and serve as a means of vegetative reproduction.

Even in the simpler Florideophycidae, sexual reproduction displays a number of features not encountered in other divisions of the algae. The male and female gametangia, in many species produced on separate plants, arise on specialized side branches. In *Nemalion* (Fig. 2.15b), for example, the antheridia are budded off from mother cells lying at the tips of short tufted branches; as many as four or five antheridia may come from one mother cell. Each antheridium liberates a single spermatium through an apical slit. The carpogonium, surmounted by a long tubular, hair-like process (the *trichogyne*) terminates a short carpogonial branch. When a spermatium makes contact with a trichogyne above an unfertilized egg, it becomes attached, and the intervening cell walls break down, allowing the contents of the spermatium to pass into the carpogonium. After fertilization a mucilaginous plug is secreted at the base of the trichogyne. The zygote germinates almost immediately and becomes surrounded by a dense tuft of short, occasionally branching, filaments, often with brownish pigmentation. Carpospores are cut off from the ends of these filaments (Fig. 2.15c). Germination leads to a branching filamentous

diploid phase. Meiosis occurs in tetrasporangia which arise, in short-day conditions, from single cells terminating filaments. The original nucleus yields four haploid tetraspores. The tetraspores pass through a filamentous stage before yielding the multiaxial mature gametophyte. The Mediterranean *Liagora* is similar to *Nemalion* in growth form and life history, but has a more compact structure and is appreciably calcified.

Batrachospermum shows a simpler cycle. The carpospores germinate to form a small heterotrichous *Chantransia* stage, which may reproduce itself by monospores. There are no tetrasporangia. Meiosis occurs sporadically in cells toward the tips of the erect branches. Some of the cells containing haploid nuclei grow into the characteristic gametophytic plant (Fig. 2.16).

In an advanced member of the Florideophycidae, such as *Polysiphonia*, the initiation of sexual reproduction is much as in simpler forms. Antheridia are produced in the middle region of short filaments. When mature the filaments become club-shaped, with the antheridia, almost colorless and with refractive walls, densely packed at the surface.

Development of the female filament is more complex. Although initially a single file of cells, all but the tip becomes multicellular. One of the peripheral cells in the central region gives rise to a carpogonial branch terminating in a carpogonium surmounted by a trichogyne. The basal cells divide sparingly giving rise to a few auxiliary cells all lying close to the carpogonium. During the development of this carpogonial branch adjacent peripheral cells divide and form an urn-shaped sheath which grows up and ultimately encloses the carpogonial branch. This structure, from which only the trichogyne projects is termed the *pericarp*.

Following fertilization the trichogyne degenerates and the zygote makes a pit-like connection with an adjacent auxiliary cell. The diploid nucleus then migrates into this cell and its original haploid nucleus apparently degenerates. The diploid nucleus divides mitotically and a small branching, filamentous carposporophyte is produced. Simultaneously, evidently stimulated by fertilization, the pericarp grows into the mature cystocarp which completely encloses the carpos-

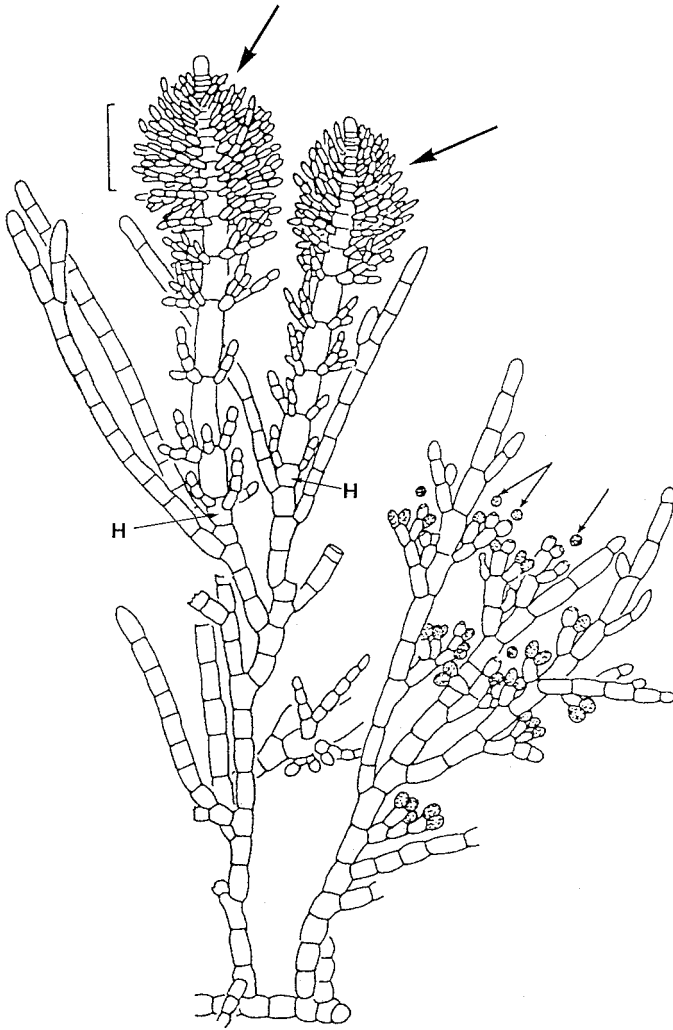

Figure 2.16 *Batrachospermum*.

Diploid *Chantransia* stage reproducing by monospores (arrows, lower right), and generating from haploid cells (H) two young *Batrachospermum* plants of mature form (arrows, above). Scale bar 100 μm . (From Van den Hoek, Mann and Jahns. 1995. *Algae: An Introduction to Phycology*. Cambridge University Press, Cambridge.)

Life histories of the Rhodophyta

The red algae as a whole are remarkable for the diversity of their life histories. In some dioecious forms the male and female gametophytes have different morphologies. In *Palmaria palmata*, a widely distributed littoral perennial, for example, the female gametophyte is crustose, but the male has a blade-like thallus. This species also has a peculiar cycle, lacking the carposporophyte phase seen in *Polysiphonia*. Instead the zygote formed at fertilization yields a blade-like tetrasporophyte, which ultimately overshadows the minute female gameto-

porophyte. Ultimately the terminal cells of the carposporophyte filaments become carposporangia. Each liberates a single densely pigmented carpospore. These escape through the apical orifice (ostiole) of the cystocarp (Fig. 2.17b).

The diploid carpospores germinate directly and give rise to plants quite similar to the gametophyte. Segments toward apices of the branches become fertile. A peripheral cell undergoes a number of divisions leading to a structure not unlike a carpogonial branch. In this branch one or more of the cells give rise to tetrasporangia. Meiosis leads to the formation of four tetraspores. These escape by rupture of the sporangium (Fig. 2.17c) and germinate to form normal gametophytic plants.

Meiosis yields both male and female haploid spores, presumably in equal numbers, although this has not been confirmed. Many red algae have been found to display apomictic cycles, but irregular cycles detected in laboratory cultures are not necessarily present in natural conditions.

In *Griffithsia*, belonging to the same order as *Polysiphonia*, vegetative cells from male and female haploid plants have been fused experimentally (parasexual fusion). The resulting heterokaryons, analogous to those of ascomycete and basidiomycete fungi, generate plants with diploid (tetrasporangiate) morphology. Actual nuclear fusion, as occurs in sexual reproduction, is therefore not essential for the new form of growth. Some

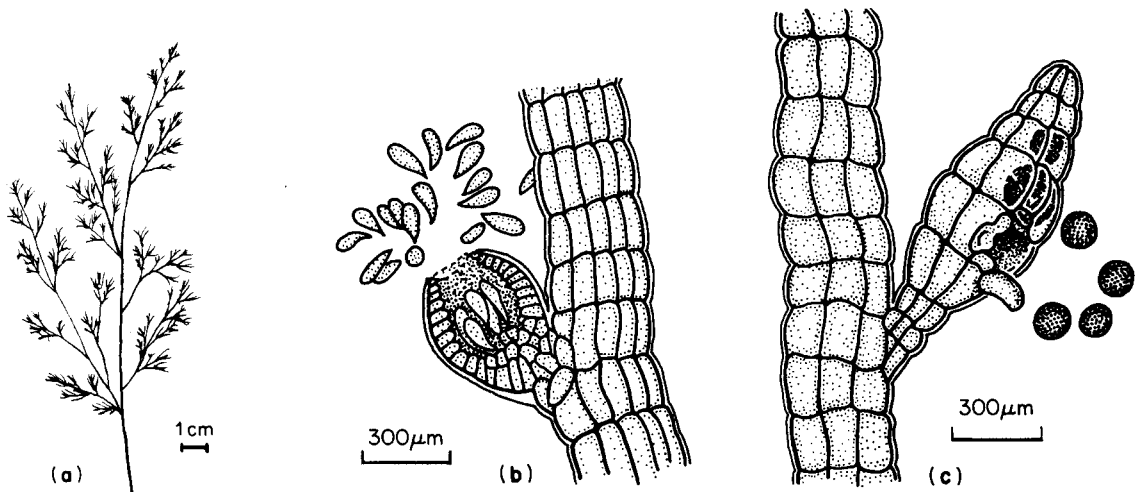

Figure 2.17 *Polysiphonia*. (a) Habit. (b) Mature cystocarp discharging carpospores. (c) Sporophyte with a tetrasporangiate branch, some of the tetraspores escaping.

nuclear fusion presumably occurs subsequently since functional tetrasporangia have also been observed following parasexual plasmatic fusion.

Aberrant life cycles have also been discovered in natural populations of advanced Florideophycidae. In some instances nuclear division in the tetrasporangia is mitotic and not meiotic.

Relationships of the Rhodophyta

The absence of all but a few unicellular representatives of the Rhodophyta makes the assessment of the wider relationships of the division difficult. Motile forms are conspicuously absent.

The similarities, both biochemical and structural, between the chloroplasts of the Rhodophyta, the “cyanelles” of the Glaucophyta, and the photosynthetic cells of the Cyanophyta are certainly striking. In all, for example, the biliproteins are present in some Rhodophyta as phycobilisomes lying outside the paired thylakoids. The transition from the prokaryotic to the eukaryotic condition could have taken place either by the peripheral intrusions of the plasmalemma forming the photosynthetic and respiratory membranes of a cyanophyte having become internalized and enveloped by bounding membranes

(Chapter 1), or by a unicellular cyanophyte invading an already existing heterotrophic eukaryote and ceasing to be recognizable as an individual. Both routes are conceivable, and both are likely to remain matters for speculation into the foreseeable future.

Nucleotide sequence analyses made so far have surprisingly failed to confirm that the Rhodophyta are an ancient lineage. They appear instead to have arisen about the same time as the Chlorophyta (p. 71). Nevertheless, the fossil history of the rhodophytes is impressive. Fossils which can be recognized with fair certainty as representative of coralline red algae first appear in the Cambrian, and remains which closely resemble the extant coralline genus *Amphiroa* are known from the Upper Devonian. All the coralline rhodophytes belong to the Florideophycidae. It can be assumed that non-coralline rhodophytes have a history at least as long or longer. Studies of RNA nucleotide sequences indicate the primitiveness of the Bangiophycidae relative to the Florideophycidae. This is supported by fossil evidence. Silicified filaments resembling those of *Bangia* are known from mid-Proterozoic rocks (900–1200 million years old) in arctic Canada, and filamentous fossils resembling *Conchocelis* (p. 32) have been reported from Silurian deposits. Remarkably well-preserved fossils from the late Proterozoic in China (c. 570 million years old) indicate the presence of red algae of some complexity, some showing evidence

of fountain-like growth (p. 34), and possible *Porphyra*-like reproductive organs.

The Glaucophyta (p. 27) may be descendants of distant flagellate ancestors of the red algae, the flagella being lost as the Rhodophyta became distinct. The presence of rudimentary flagella in *Glaucocystis* (Fig. 2.9) is in line with this view.

There is an undoubted similarity between the reproductive process in *Polysiphonia* and that in ascomycete fungi, but, if this resemblance is anything more than coincidental, it seems more likely that the fungi, being heterotrophic, are the derived forms.

The subkingdom Algae: Part 2

Algae containing chlorophylls *a* and *b*

In proceeding from the “chlorophyll *a*” to the “*a* + *b*” algae a striking difference is seen in the arrangement of the photosynthetic thylakoids. Thylakoids whose membranes contain only chlorophyll *a* tend to be clearly separate from each other. In the presence of chlorophyll *b* the apposed faces of the thylakoids are closely appressed, either generally or regionally. The stacking of the thylakoids may be in pairs or in greater numbers. This stacking of the thylakoids remains a feature of the land flora, all of which are “*a* + *b*” plants.

Prokaryotic forms

The prokaryotic algae containing chlorophylls *a* and *b* are placed in the Prochlorophyta. So far only a few examples are known and the classification is clearly tentative.

PROCHLOROPHYTA

Habitat Symbiotic, freshwater, marine.

Pigments Chlorophylls *a*, *b*; β -carotene (α -carotene in one form); zeaxanthin.

Biliproteins absent.

Food reserves Starch (where known).

Cell wall components Probably cyanophyte-like.

Reproduction Presumably asexual.

Growth forms Unicellular, filamentous.

Flagella None.

Of the three prochlorophytes discovered *Prochloron* is the most studied. It is a unicellular extracellular symbiont of colonial ascidians of tropical and subtropical waters. The cells are 10–20 μm in diameter, and divide by binary fission. The thylakoids are more or less concentric and closely stacked. A vacuole may be present, but this seems to be more in the nature of an inflated thylakoid than a discrete sac, as in eukaryotic cells. The ribosomes are similar in size to those of the Chlorophyta, but the ribosomal RNA is more like that of the Cyanophyta. Another cyanophyte-like feature is the presence of carboxysomes (p. 24).

Prochlorothrix is free-living, filamentous and planktonic, and was first discovered in shallow eutrophic pools in Holland. It is capable of being grown in pure culture in mineral medium. The filaments reach a width of 0.7 μm and consist of elongated cells without a conspicuous sheath. The thylakoids run parallel to the walls and lie close together. Gas vesicles (p. 25) are present in the cytoplasm.

A third prochlorophyte, *Prochlorococcus*, also free-living, has been discovered as a prominent component of picoplankton (the plankton which will pass through a 2.0 μm mesh). In the eastern equatorial Pacific *Prochlorococcus* accounts for a notable fraction of the photosynthetic biomass, and 13–48 percent of the total net production, the proportion rising to as high as 80 percent locally. The success of *Prochlorococcus* in this respect appears to follow from the presence in a popula-

tion of a number of strains genetically adapted to different light levels so that the aggregate production is maintained over a wide range of irradiances. The cells measure only 0.6–0.8 μm in diameter, and are thus smaller than many coccoid Cyanophyta. The thylakoids are concentric and closely stacked. The principal photosynthetic pigment in addition to chlorophyll *b* is a divinyl chlorophyll *a*. α takes the place of β -carotene.

RNA sequence studies indicate that the Prochlorophyta are a heterogeneous group, each probably having originated independently from cyanophyte sources. *Prochloron* seems to be closer to the cyanophytes than to chloroplasts. On balance, there is little evidence that “*a+b*” prokaryotes are direct ancestors of green chloroplasts, and the name Prochlorophyta now seems unfortunate.

Eukaryotic forms

The cells of all “*a+b*” algae other than the Prochlorophyta are eukaryotic, and in respect of the photosynthetic mechanism have much in common with higher plants.

CHLORACHNIOPHYTA

Habitat Warm marine; planktonic.

Pigments Chlorophylls *a*, *b*. Other thylakoid pigments await identification. Biliproteins absent.

Food reserves Possibly β -1,3 glucan, outside plastids.

Cell wall components None, except around cysts; chemical nature not known.

Reproduction By fission, or zoospores following cyst formation.

Growth forms Amoeboid; cysts formed in depleted medium.

Flagella Confined to zoospores, one only, inserted below apex and wrapped downward around the cell. Delicately hairy.

The division Chlorachniophyta contains a single genus, *Chlorachnion*. It forms floating colonies of bright green cells, each about 10 μm in diameter, entirely naked and connected by protoplasmic extensions (filipodia or reticulopodia). The chloroplasts are regularly bilobed with a promi-

nent projecting central pyrenoid, and surrounded by one or two sheets of endoplasmic reticulum.

Spherical walled cysts are formed in aging cultures. These germinate in fresh medium to give rise directly to the amoeboid stage, or to zoospores. These bear a single lateral flagellum furnished with fine hairs. They sometimes appear to be produced in tetrads, but it is not known whether meiosis is involved. On settling the zoospores regenerate the amoeboid stage.

Chlorachnion has so far been found only in a few warm marine habitats. The conspicuous manner in which its chloroplasts are ensheathed in endoplasmic reticulum suggests that it may have arisen in the past from a heterotrophic amoeboid organism which incorporated chloroplasts from another source. A pocket in the prominent pyrenoid encloses a nodule of DNA surrounded by two membranes. This structure, possibly retained from an ancestral endosymbiont, is referred to as a *nucleomorph*. Some have considered the chloroplast and nucleomorph of the Chlorachniophyta to have had a red algal origin (see also Cryptophyta, p. 96). Despite the sheathing of the chloroplast and the presence of the nucleomorph both being heterokont features, the structure of the single flagellum of the zoospore of *Chlorachnion* is quite different, and a relationship with the heterokonts seems improbable.

CHLOROPHYTA

Habitat Aquatic (mainly freshwater), terrestrial in moist situations, a few epiphytic.

Pigments Chlorophylls *a*, *b*, β -carotene (α -carotene less prominent); lutein, violaxanthin, neoxanthin; other carotenoids less widely distributed.

Food reserves Starch, rarely inulin, oils and fats.

Cell wall components Cellulose, crystalline glycoproteins, various hemicelluloses; occasionally material resembling, but possibly not identical with, sporopollenin.

Reproduction Asexual and sexual (isogamy, anisogamy and oogamy).

Growth forms Flagellate, coccoid, filamentous, rarely foliaceous or siphonaceous.

Flagella Two or four, occasionally numerous, hairs or scales inconspicuous.

The Chlorophyta (green algae) in respect of metabolism, photosynthetic pigments and ultrastructure show much in common with the vascular plants and the bryophytes. We shall here consider the commoner representatives and other species of interest contained within the classes shown in Table 2.1. The classification of the Chlorophyta, initially depending largely upon the degree of development of the thallus and, where present, the nature of the sexual reproduction, now rests increasingly upon ultrastructure and comparative biochemistry. The shape of the chloroplast (chromatophore) remains however a useful and fairly readily observable feature. In some genera they are characteristically large, and are present singly or in very small numbers in each cell.

Prasinophyceae

This class consists principally of unicellular planktonic organisms, and their classification is often a matter of debate. The flagellate representatives include *Micromonas* (**Pedinomonadales**) (Fig. 1.4) and *Pyramimonas* (**Pyramimonadales**). *Micromonas*, abundant in the sea, is naked. The single axoneme is unusual in that the peripheral microtubules do not ascend above the lower portion of the flagellum. The central pair of microtubules also appears to rotate in (when viewed from the tip) an anticlockwise direction independently of the rest of the flagellum. Reproduction of *Micromonas* is by fission. Electron micrographs reveal that the mitochondrion and plastid divide at the same time as the cell. *Pyramimonas* has four flagella set in an apical pit. Two kinds of scales are found on the flagella; on the body of the organism they are intermixed with yet a third kind. The scales reach the surface through a canal opening into the apical pit near the insertions of the flagella. Non-motile forms assigned to the Prasinophyceae include *Halosphaera*, whose bright green spherical cells are frequent in plankton, and *Osteococcus* described from Mediterranean meres. The latter is one of the smallest eukaryotes known, the cells measuring $0.8\text{--}1.1\ \mu\text{m} \times 0.5\text{--}0.7\ \mu\text{m}$ and containing a single nucleus, chloroplast and mitochondrion. There are no scales. The attribution of this form to the Prasinophyceae is supported by the chlorophylls *a* and *b* being accompanied by a chlorophyll *c*-like compound, a feature of several members of this

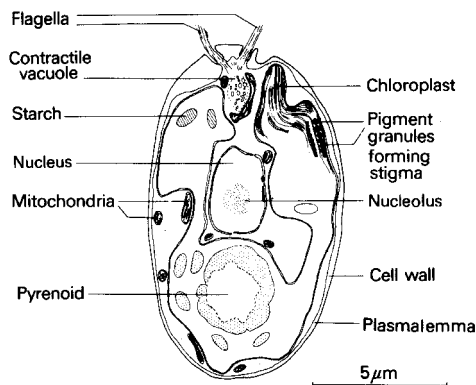

Figure 3.1 *Chlamydomonas reinhardtii*. Longitudinal section of cell. (From electron micrographs by Ursula W. Goodenough.)

class. The **Pterospermatales** are also non-motile and characteristically thick-walled. Despite the abundance of many of the prasinophytes, the life cycles are imperfectly known. No form of sexual reproduction has been detected.

Unicellular forms recalling prasinophyte algae have been recorded from Proterozoic deposits in China and the South Urals. *Tasmanites*, a spore-like fossil of the Devonian and subsequently, is believed to have been the resting cyst of a prasinophyte. The wall contains material originally thought to be sporopollenin, but now known to be aliphatic and to consist of polymerized fatty acids.

The organization of the genome of the chloroplast DNA of the flagellate prasinophyte *Mesostigma viride* is remarkable for being very similar to that of the genome of chloroplast DNA of charophytes and land plants. This has led to the suggestion that *Mesostigma* may be representative of those early green algae within which a line of evolution became established which led ultimately to the colonizers of the land (Table 3.1).

Chlorophyceae

The Chlorophyceae fall into a number of well-defined orders. The **Volvocales**, for example, range from unicellular to a unique multicellular form (*Volvox*), but a simple biflagellate cell is a structural element common to the order.

Unicellular forms of the Volvocales

Representative of the unicellular forms of the Volvocales is *Chlamydomonas*, numbering some 400

species, mostly freshwater. The cells, which rarely exceed 30 μm in major diameter, contain a single chloroplast, usually basin-shaped and taking up about 40 percent of the volume of the cell, and one or more mitochondria (Fig. 3.1). Toward one side of the chloroplast, in which the thylakoids show loose stacking forming irregular grana, lies a conspicuous pyrenoid, the site of the enzyme RUBISCO. A granular stigma ("eyespot"), associated with a bovine-like rhodopsin and carotenoid pigments, also lies within the chloroplast. Although possibly photosensitive, this property is not confined to the stigma, since phototaxis persists in mutants in which it is lacking. Each cell also contains two pulsating vacuoles which discharge their contents at short intervals, and so play an important rôle in the osmoregulation of the cell. The two flagella are inserted into narrow pits at the apex of the cell. The emergent portion is finely hairy.

The cell wall of *Chlamydomonas* lacks cellulose and consists of a number of layers, some of which take the form of a crystalline lattice made up of glycoprotein subunits. The sugars involved are mannose, arabinose and galactose. Forms related to *Chlamydomonas* have a similar wall, but with differences in detail.

Cultures of *Chlamydomonas* can be raised so that the cells divide synchronously, facilitating the study of metabolic changes during the cell cycle. *Chlamydomonas* has also figured prominently in research into chloroplast genetics, and an insight into the control of wall formation has been gained from wall-less mutants. Knowledge of the nature and regulation of flagellar movement has also come from *Chlamydomonas*. The whole flagellar apparatus, its function unimpaired, can be isolated and studied *in vitro*. The breast-stroke motion of the flagella (Fig. 3.2), which is uniplanar, can be reversed by increasing the concentration of calcium ions in the medium. Dissection has also shown that the natural beat of the flagellum adjacent to the eyespot is lower than that of its fellow. The beat is nevertheless synchronized in the intact cell.

On a flat surface the behavior of the flagella is modified. The cell shows a gliding motion in which only one flagellum participates.

The basal bodies of the flagella contain RNA, but the presence of DNA, possibly controlling their replication, remains disputed.

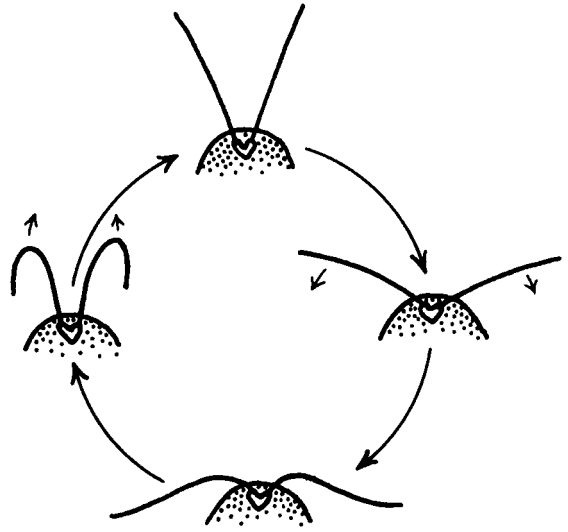

Figure 3.2 The beating cycle of the paired flagella of *Chlamydomonas*.

REPRODUCTION

Chlamydomonas multiplies asexually by fission. The parent flagella are resorbed and the nucleus divides. The spindle, however, is transient and the subsequent cytokinesis involves the formation of a phycoplast (Fig. 2.2A). Divisions may be successive, resulting in up to eight daughter cells (*aplanspores*). These secrete cell walls and regenerate flagella from the replicated flagella bases before being liberated. On an agar surface they may however continue to lack flagella and form palmelloid colonies. As the cells grow to their mature size, newly synthesized glycoprotein enters the wall and the crystalline lattice is maintained.

Sexual reproduction involves the production and fusion of gametes. Gametes are structurally similar to vegetative cells, but smaller. Gametogenesis can be induced by culturing in medium deficient in nutrients (particularly nitrogen). Differentiating gametes show a partial loss of ribosomes. Mating structures, recognizable as slightly protruding areas, differentiate between the flagella bases.

Fusion of morphologically similar gametes (isogamy), the simplest method of combining nuclear information, is found in some species of *Chlamydomonas*, but other species show anisogamy, and a few oogamy. Aggregation of gametes is promoted by agglutinins, complexes of membrane and glycoprotein shed from the flagella of

Figure 3.3 Mating and zygote formation in isogamous *Chlamydomonas*.

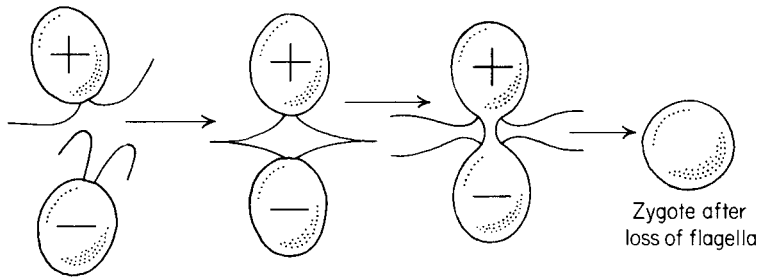

activated cells. In the isogamous species studied, two strains (+ and -) are present, and mating is possible only between opposed strains. When cultures of the + and - strains are mixed there is first animated cell movement, and then pairing of opposed strains (Fig. 3.3). The initial contact seems to occur by chance; there is no evidence of chemotactic attraction between the two strains. Fusion begins at the tips of the flagella (Fig. 3.3). The flagella then extend laterally and come to lie side by side. Simultaneously a special enzyme (a metalloprotease) is activated which digests the inner cell wall, liberating the protoplasts from their shells. As the cells become accurately aligned, a fertilization tubule, rich in polymerized actin, grows out from the mating structure of the + strain into the cup of the corresponding structure of the - strain. A protoplasmic bridge then forms between the apposed cells and the flagella simultaneously cease to pair. The bridge now widens and the mating cells become a single quadriflagellate zygote. Fusion is completed in 15–20 minutes. Recognition and adhesion of gametes of opposed mating type, and actual fusion of the cells, are under separate genetic control. Experiments show that (+) mutants show defects in adhesion and (-) mutants in fusion.

Zygotes continue to swim, but show negative phototaxis and eventually settle, although in one species (*C. variabilis*) the swimming phase lasts long enough for the zygotes to have been formerly described as a separate organism. Settling of the zygotes is accompanied by loss of flagella and the secretion of a thickened wall, in at least one species containing sporopollenin-like material.

Reproduction is anisogamous in *C. braunii*, the - strain producing four macrogametes and the + strain eight microgametes. The oogamous state is approached in *C. coccifera* in which the cells of one strain produce a single macrogamete and those of the other 16 or 32 microgametes. It is reasonable to envisage anisogamy having evolved from

isogamy, and experiments with isogamous strains have shown how this may have come about. A large number of mitoses before gametogenesis results in smaller gametes. Controlling the number of mitoses in cultures of different mating types can thus lead to gametes differing in size. Anisogamy (and ultimately oogamy) could have resulted from differences of this kind having become genetically fixed and linked with mating type.

Meiosis occurs on germination of the zygote and four new individuals are produced. There is 2:2 segregation of mating type, indicating Mendelian inheritance of this feature. The chloroplast DNA of the mt- parent, however, is absent from the mature zygote, so inheritance of the plastid DNA is uniparental. The destruction of the mt- plastid DNA following syngamy appears to be controlled by a gene in the mt+ locus. How the mt+ plastid DNA comes to be protected from digestion is not entirely clear, but methylation of the DNA is probably involved.

Although representative of the simplest eukaryotic green plants, *Chlamydomonas* clearly possesses features of structural and functional complexity far more impressive than those found in the prokaryotic algae. It would appear that the attainment of the nucleate state represents an advance in organization without which others, such as flagellate motility and probably sexual reproduction, are impossible.

OTHER UNICELLULAR FORMS

An alga similar to *Chlamydomonas*, but lacking a cell wall, is *Dunaliella*. In conditions of extreme salinity (e.g., in salt pans and in the Dead Sea) *Dunaliella* accumulates glycerol to such a high concentration that the cells are able to resist desiccation by exosmosis. In these conditions the cells often become pigmented bright orange, and appear able to toler-

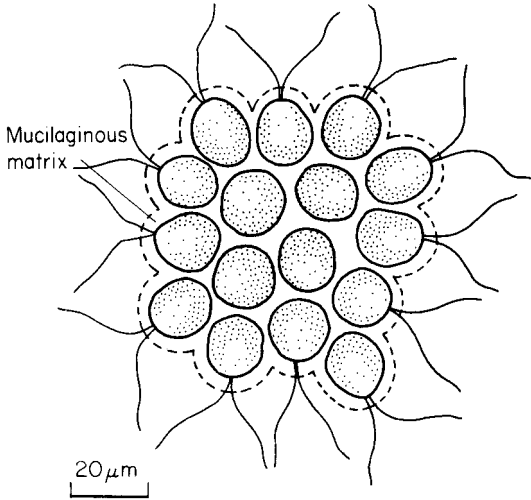

Figure 3.4 *Gonium*.

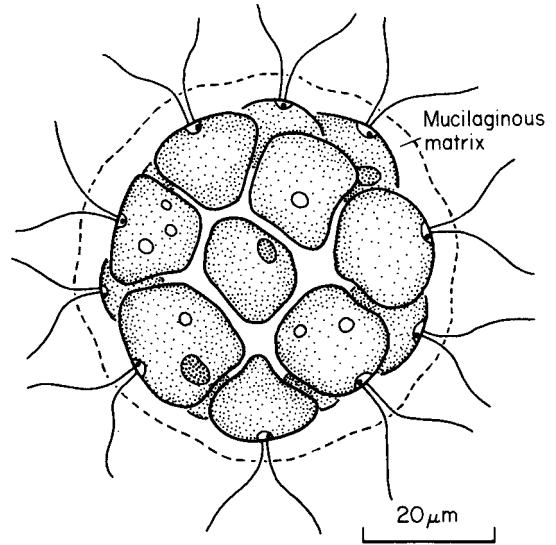

Figure 3.5 *Pandorina*.

ate very high light intensities. Another species of *Dunaliella* (*D. acidophila*), occurring in sulfurous volcanic springs, can be grown in 1 percent sulfuric acid, if suitably illuminated and supplied with sources of nitrogen and phosphorus. On the basis of its structure, *Polytoma*, a heterotrophic form found between rotting plant remains, is also probably related to *Chlamydomonas*. It lacks chlorophyll, and the plastid, in the place of thylakoids, contains tubules. A similar chlorophyll-less mutant of *Chlamydomonas* has been obtained by UV irradiation. *Polytoma* retains the ability to accumulate starch.

Morphology and reproduction of motile colonies

The Volvocales also contain motile colonies, composed of identical cells, each similar in morphology to *Chlamydomonas*. *Gonium* (Fig. 3.4), for example, has a flat plate of 4 or 16 cells (depending upon the species) which are regularly arranged, and held together in a tough mucilaginous matrix. The 16 cone-shaped cells of *Pandorina* (Fig. 3.5), however, are arranged in a sphere. In both asexual reproduction (in which a single cell gives rise to a new spherical colony) and gametogenesis, all the cells of these simple colonies become involved simultaneously.

In *Volvox* itself (Fig. 3.6) there is evidence of both coordination of activity and division of labor

between the constituent cells. The organism takes the form of a hollow sphere, the number of cells forming its surface always being a power of 2, indicating synchronized division during growth. The cells, which individually resemble *Chlamydomonas*, are held together by mucilage. The refractive boundaries between the sheaths of individual cells often give a hexagonal pattern to the surface. The center of the sphere is filled with less viscous mucilage. The cells remain connected by cytoplasmic strands, a feature of significance in relation to the coordination of their activity. The flagella, for example, beat in unison, producing a steady rolling motion. Despite the radial symmetry the organism has an anterior and posterior. In the anterior region the stigmata are more conspicuous than elsewhere. Some species may reach diameters of almost 1 mm (0.04 in.).

REPRODUCTION OF VOLVOX

Asexual reproduction takes place by the enlargement and repeated longitudinal division of a vegetative cell so that eventually a new sphere of cells is formed bulging into the hollow center. Initially the cells of this daughter individual are oriented inversely in relation to those of the mother, but at the completion of cell division the new sphere invaginates and the orientation of the cells consequently reverses. The daughter is simultaneously

Figure 3.6 *Volvox*. (a) Asexual reproduction, three daughters lying within the cavity of the parent. (b) Detail of the connections between individual cells.

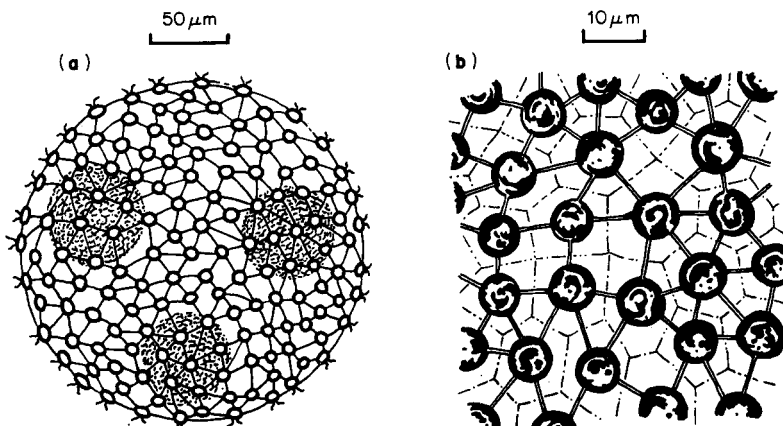

liberated into the cavity, and may even itself generate a daughter before it is released by the death of the original mother. On release, the daughter organism expands to its mature volume. The mucilage surrounding the colonies of *Volvox aureus* is inhabited by the bacterium *Pseudomonas fluorescens*. Daughter colonies removed aseptically from the center of the parent are not viable unless supplied with the bacterium, an example of a symbiotic relationship probably widespread in the algae.

Sexual reproduction in *Volvox*, in which both monoecious and dioecious species occur, is truly oogamous. The gametangia may develop from any cell or, when the distinction of anterior and posterior is well marked, be confined to the posterior region. The mature oogonia are large flask-shaped cells without flagella. Each is developed from a single vegetative cell, and remains in position up to and during fertilization. The male organ, the antheridium, similarly develops from a vegetative cell. Successive divisions lead to a bowl-shaped mass of biflagellate spermatozooids (antherozoids). After release, the aggregate migrates to an oogonium and there, in the interior of the colony, breaks up into individual gametes. The details of fertilization are little known. Subsequently the zygote forms an oospore which in some species acquires a thickened wall and is able to survive unfavorable conditions. Meiosis occurs at germination, but since only one flagellate swarmer is released three of the meiotic products evidently fail to survive. Successive divisions of the swarmer lead to a small spherical individual, but after repeated asexual reproduction the mature size characteristic of the species is ultimately regained.

In some dioecious species individuals entering the sexual phase and becoming female can induce others still vegetative to become male, a consequence of a "male inducing substance" (which

appears to be a glycoprotein), secreted by the female. This is only one example of such correlative systems in *Volvox*, and the situation in the genus as a whole is evidently complex.

TRANSITION FROM COLONY TO MULTICELLULAR INDIVIDUAL IN THE VOLVOCALES

Volvox differs from simpler Volvocales in possessing somatic cells which play no part in reproduction. These cells consequently perish when an individual ruptures to release a daughter, or when its integrity is destroyed by the liberation of numbers of oospores. Because of the evident organization in the thallus, and the presence of somatic cells, the term colony is inappropriately applied to *Volvox*. This organism has reached the level of a multicellular individual. In the Volvocales as a whole, the transition from colonial forms to *Volvox* is a gradual one, and although the status of *Volvox* is unambiguous that of many of the intermediates is less clearly defined. The term *coenobium* is often used for a colony of cells in which there is some degree of coordination.

Despite the sequence of forms leading from *Chlamydomonas* to *Volvox*, it would be wrong to assume that evolution of the Volvocales has taken place in a linear fashion. Molecular evidence points to complex intergeneric relationships within the order.

The Tetrasporales

The Tetrasporales are a small order of simple algae consisting of *Chlamydomonas*-like cells embedded

in mucilage. The cells either lack flagella, or possess flagella which are either non-motile (e.g., *Tetraspora*) or move only feebly in the mucilaginous matrix. Motility is usually present in the reproductive stages (zoospores and gametes). The zoospores of some species have four flagella.

The Chlorococcales

The Chlorococcales are a heterogeneous order of lowly green algae in which motility is confined to zoospores and gametes. Although there are common features in reproduction, the Chlorococcales show much diversity, and interrelationships appear distant. Since rudimentary basal bodies have been detected in some of the non-motile unicellular forms, the origin of the Chlorococcales perhaps lay in some early flagellate group. Most living members of the order occur in fresh waters, a few live in the oceans and moist places on land, and others are endophytic in the intercellular spaces of higher plants, symbionts with lower animals, or constituents of lichens.

Chlorococcum and *Chlorella* are unicellular, the latter occurring free in both soil and water, and as the endosymbiont in the coelenterate *Hydra*. *Chlorella*, one of the plants with which Priestley and Ingenhousz first demonstrated photosynthesis in 1779, has been used extensively in studies of algal metabolism. The thin cell wall contains polymerized fatty acids, yielding a layer with some of the features of sporopollenin, possibly enhancing the water-repellent properties of the wall. Another unicellular form, *Botryococcus*, is commonly planktonic, and sometimes forms water blooms. Up to 75 percent of its dry weight may consist of hydrocarbons, and the dried remains of blooms resemble sheets of crude rubber. *Oocystis*, ellipsoidal in shape but similar to *Chlorella*, has figured prominently in studies of the manner in which the layers of cellulose microfibrils are deposited successively in the developing cell wall. *Prototheca*, a parasite of fish, is also placed in the Chlorococcales. Although heterotrophic and colorless, the cells resemble those of *Chlorella*, and the plastids accumulate starch. The unicellular (and autotrophic) *Chlorochytrium* is found as an endophyte in the cells of foliose red algae, such as *Dilsea*, not uncommon at low tide levels in the

northern hemisphere. At least one other species of *Chlorochytrium* is able to penetrate the leaves of the floating angiosperm *Lemna* and live endophytically between the cells.

Despite its minute size, *Nanochlorum eucaryotum*, from the Adriatic, is also tentatively placed with the Chlorococcales. The cells do not exceed 2.0 μm in diameter and contain a single nucleus, chloroplast, Golgi body, and mitochondrion. Acetolysis-resistant material in the wall may again consist of polymerized fatty acids rather than sporopollenin.

The unicellular *Hemichloris antarctica* is probably also attributable to the Chlorococcales. It forms colonies in moist crevices in sandstone rocks in antarctic deserts. It is evidently capable of withstanding repeated freezing and thawing over long periods. The cells divide only very rarely and some colonies are estimated to be over 1000 years old.

Scenedesmus (Fig. 3.7) and *Pediastrum* (Fig. 3.8) are representative of the simpler coenobial forms. Species of *Scenedesmus* are fairly frequent in fresh and brackish water, and some are able to tolerate relatively high concentrations of copper. The identification of acetolysis-resistant material in the wall of *Scenedesmus* with sporopollenin is (as in *Chlorella*) now regarded as doubtful. The "lignin" reported in the spines may be a polymerized diterpene, as in the dinoflagellates (p. 95). Silica is a structural component of the cell walls of *Pediastrum*.

Hydrodictyon is altogether remarkable. The multinucleate cells, each with a reticulate chloroplast containing numerous pyrenoids, form a hollow cylindrical net with closed ends (Fig. 3.9). Individual cells may reach 5–10 mm (0.2–0.4 in.) in length, and the whole coenobium extends to 20 cm (8 in.) or more. At the other extreme is the diminutive *Protosiphon*. The thallus consists of a single sphere, about 0.3 mm (0.01 in.) in diameter, anchored to the substratum by a colorless rhizoid which may reach a length of 1 mm (0.04 in.) (Fig. 3.10). The sphere contains several nuclei, and a reticulate chloroplast with several pyrenoids. *Protosiphon* is frequent on damp mud and walls, and some forms can withstand extremes of heat and salinity, as in desert soils. Pure cultures have been shown to produce bacteriostatic substances.

Figure 3.7 *Scenedesmus*

quadricauda. Section of coenobium in the plane of the spines, based on photo- and electron micrographs. The middle layer of the three-layered wall is micellar in structure, but its chemical nature is not certain. The spines consist of bundles of micelles emerging from the middle layer.

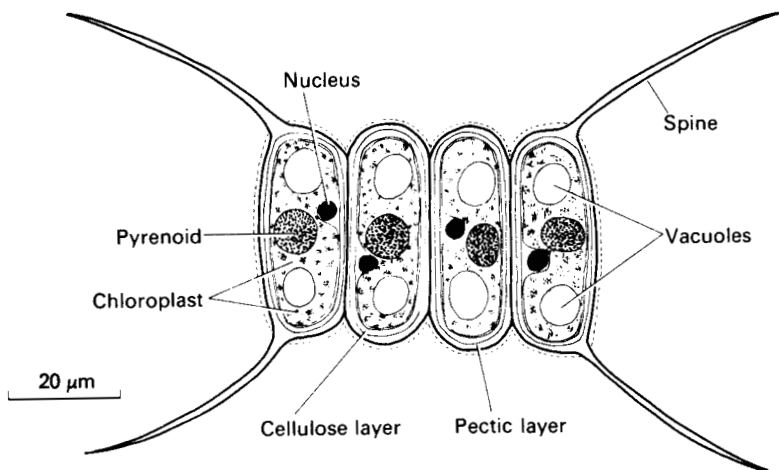

REPRODUCTION

Asexual reproduction by simple fission does not occur in the Chlorococcales. In

Chlorella the nucleus undergoes two (or more) mitoses, and the cytoplasm is divided between the daughter nuclei. A cell wall forms around each of these non-motile aplanospores. They are then liberated from the mother cell and grow to the mature size. *Glaucocystis* (p. 27) reproduces in a similar way, but, although by some formerly attributed to the Chlorococcales, no such relationship is currently considered credible.

In the coenobial forms, each cell produces aplanospores or zoospores, depending upon species. In *Scenedesmus* the aplanospores aggregate before or immediately after release to form a new coenobium. In *Hydrodictyon* the multinucleate cells become transformed into a mass of biflagellate zoospores. These are retained, shed their flagella, and then form a new coenobium within the mother cell. This ordered re-assembly is probably controlled by microtubules since in the presence of colchicine the daughter coenobium is deformed. Following rupture of the mother cell the young coenobium is free to expand to its mature size.

Sexual reproduction is isogamous or anisogamous, the biflagellate gametes conjugating laterally and not at their flagellate poles. Meiosis takes place as the zygote germinates, yielding four zoospores. Ultimately the zoospores settle, lose their flagella, and develop into conspicuous polyhedral cells known as “polyeders”. Each becomes multinucleate and germinates to release a rudimentary coenobium. This then enlarges to its mature size. In *Hydrodictyon* the young coenobium is two-layered. The individual cells enlarge and become

multinucleate, and the coenobium then acquires its typical cylindrical form.

Reproduction in *Protosiphon* is little specialized. Simple asexual reproduction takes place by budding, but biflagellate swimmers are often produced after flooding. These may behave as either zoospores or gametes. There is no evidence for the existence of mating types since gametes from the same plant may fuse. Germination of the zygote, probably the occasion of meiosis, may be immediate or delayed.

The Chlorosphaerales

The Chlorosphaerales are a small order of simple algae consisting of *Chlorella*-like cells. The cells occur in groups or short threads. *Chlorosphaera antarctica* occurs on snow. Its pigmented resting stages contribute to the “red snows” of antarctic regions. Biflagellate zoospores are produced by some species.

The Chaetophorales

A distinct advance in the organization of a filamentous thallus is found in the Chaetophorales where the thallus is typically composed of both prostrate and erect components, and is consequently termed heterotrichous. The prostrate system is typically a flat plate attached to the substratum, from which arises the erect branching system bearing the reproductive organs and often characteristic hairs. Although elements of an aerial and a prostrate system are almost always detectable, many genera show greater development of one component than of the other, some-

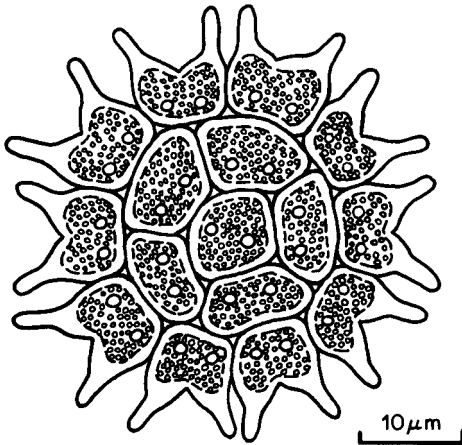

Figure 3.8 *Pediatrum*.

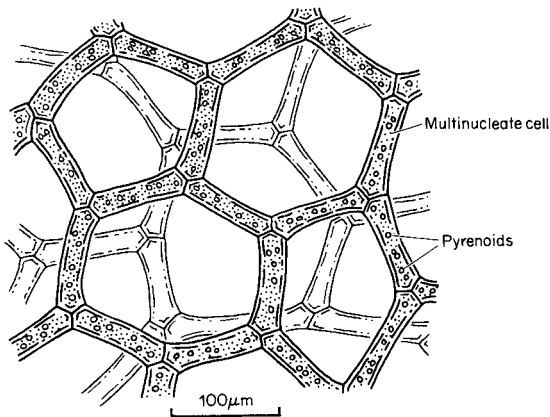

Figure 3.9 *Hydrodictyon*. Portion of the cylindrical reticulum of a growing individual showing the multinucleate cells with conspicuous pyrenoids. (After Esser. 1976. *Kryptogamen*. Springer-Verlag, Berlin.)

times almost to its exclusion. The maintenance of the dominance of one system has been shown in some species to depend upon environmental factors. In *Stigeoclonium* (Fig. 3.11), for example, magnesium depresses the growth of the erect system, while an excess of nitrogen inhibits that of the prostrate component.

Environmental factors, as well as affecting the quantitative relationships of the two systems, also influence the extent to which the erect system produces hairs and branches. Hairs may be concerned with the absorption of mineral nutrients. When these are deficient the production of hairs is conspicuously increased.

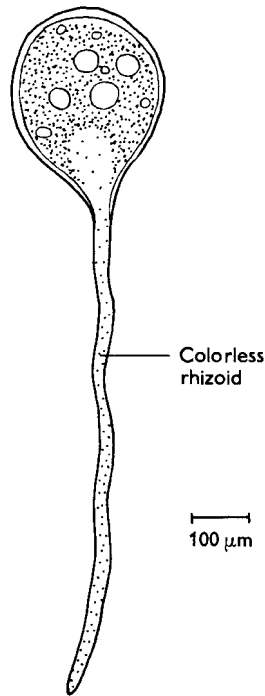

Figure 3.10 *Protosiphon botryoides*. (After Klebs, from Fritsch. 1935. *The Structure and Reproduction of the Algae*, vol. I. Cambridge University Press, Cambridge.)

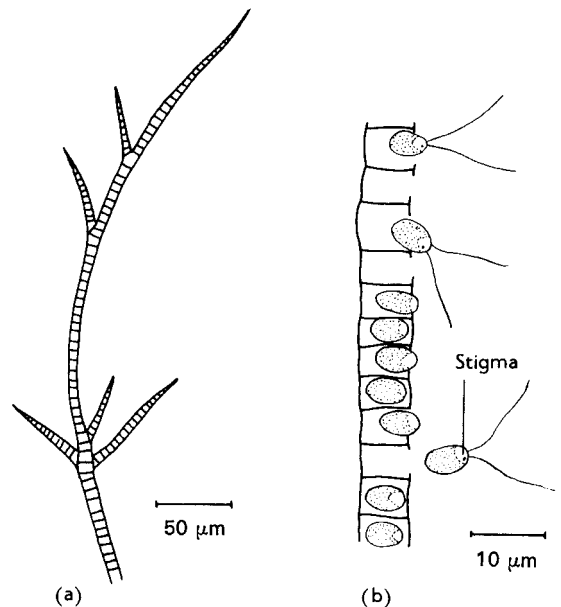

Figure 3.11 *Stigeoclonium tenue*. (a) Terminal portion of erect system. (b) Release of gametes. (After West and Fritsch. 1927. *A Treatise on the British Freshwater Algae*. Cambridge University Press, Cambridge.)

Figure 3.12 *Draparnaldia glomerata*.

Portion of erect system. (After West and Fritsch. 1927. *A Treatise on the British Freshwater Algae*. Cambridge University Press, Cambridge.)

Correlated with their morphological plasticity, the Chaetophorales show a remarkable range of habitats extending from the littoral zones of seas and lakes to damp soil (e.g., *Fritschiella*), tree trunks (e.g., *Pleurococcus*) and, particularly in the tropics and subtropics, the surfaces of leaves. Sexual reproduction is correspondingly diverse, both isogamy and oogamy being represented. The life cycle shows little development of the zygotic phase.

Stigeoclonium is representative of those members of the Chaetophorales in which both the prostrate and erect components of the thallus are easily recognizable, and each is more or less well developed. The species are commonly attached to submerged stones or woodwork, or are epiphytes on the leaves of aquatic angiosperms. They differ widely in external morphology. In general the erect system ends in long, thin, hyaline hairs, and is less branched than the prostrate system (Fig. 3.11). The latter often forms a pseudoparenchymatous sheet as a consequence of the close packing of the branches, but detailed investigation of its structure in natural habitats is rendered difficult by the tenacity with which it adheres to the substratum. The vegetative cells contain a peripheral girdle-shaped chloroplast with one or more pyrenoids.

Possibly allied to *Stigeoclonium* is the terrestrial alga *Fritschiella* in which the prostrate system, buried in damp mud, produces nodules of cells which serve as perennating organs.

The polarity of the thallus appears to be inverted in species of *Gomontia*, frequent on shells of freshwater and marine mollusks. The pseudoparenchymatous prostrate system grows on the surface, but the filaments emerge from the lower

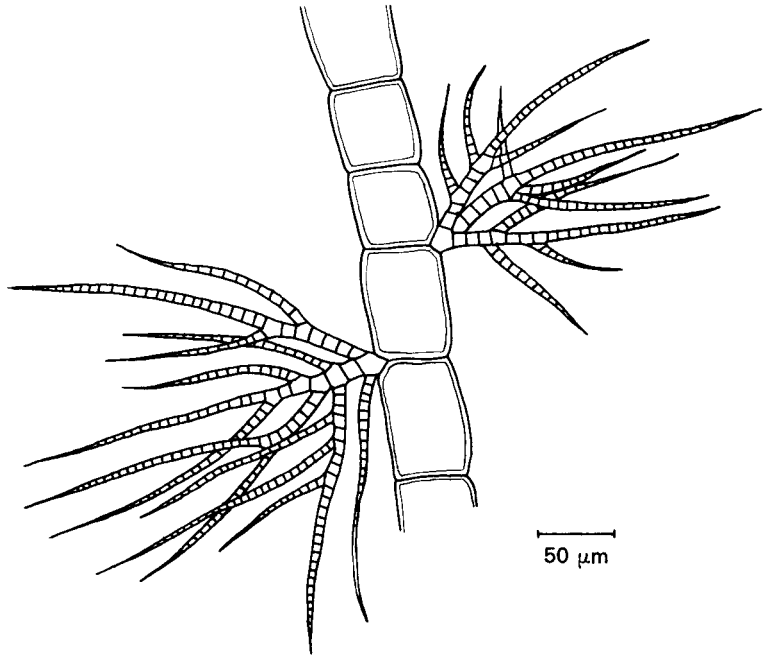

side and penetrate deeply into the substratum. The upright system is suppressed. A less extreme condition is seen in the rhizoids occurring on the underside of some chaetophorean epiphytes.

Draparnaldia and its close relation *Draparnaldiopsis* are two aquatic members of the order in which the erect system is dominant. The upright axes of *Draparnaldia* consist of large barrel-shaped cells, from which arise the highly branched whorls of laterals with much smaller cells (Fig. 3.12). Frequently these laterals, many of which terminate in hairs, are so profuse that the axis is quite obscured. The chloroplasts of the lateral branches are notably better developed than those of the axes, indicating some localization of function within the upright system. *Draparnaldiopsis* is similar, but the axis consists of long and short cells, and the whorls of fine laterals, usually originating in four tufts, arise only from the short cells. The tufts consist of radiating long and short branches. Other branches, arising particularly from the bases of the longer laterals, turn down, branch freely, and invest the internode in a cortical sheath, often thicker than the axis itself. In both genera the prostrate system is vestigial, and it is represented by a holdfast, the function of which is assisted by the outgrowth of rhizoids from adjacent cells of the main axis.

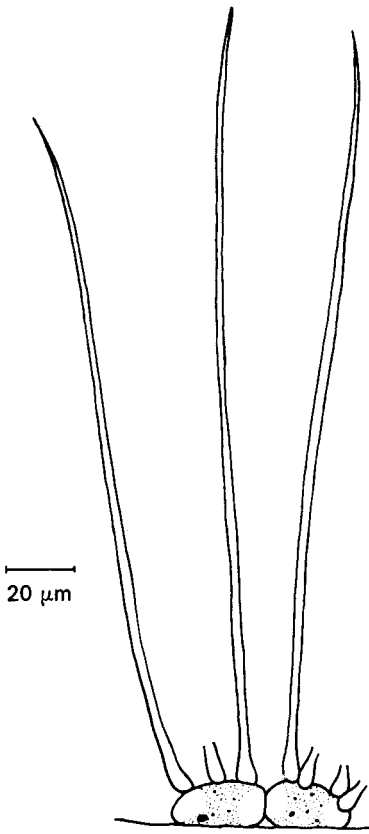

Figure 3.13 *Aphanochaete polychaete*. (After West and Fritsch. 1927. *A Treatise on the British Freshwater Algae*. Cambridge University Press, Cambridge.)

Aphanochaete (Fig. 3.13) contains a number of epiphytes common on aquatic angiosperms. The genus is representative of those members of the Chaetophorales in which the prostrate component is dominant. It is composed of cells much like those of *Stigeoclonium*, but each bears on its dorsal surface one or more hair-like cells which soon lose their protoplasmic contents. They then become brittle and are readily broken off.

Pleurococcus (*Desmococcus*) may also be referable here. The cells contain a single parietal chloroplast, and resemble those of the Chaetophorales. They occur singly, or in small groups or complanate aggregates, and occasionally in damp situations in short filaments. *Pleurococcus* is the main component of the friable incrustation (often mixed with other algae and lichens) which forms on the shaded side of walls and tree trunks. It is probably the most familiar of the smaller green algae.

REPRODUCTION AND RELATIONSHIPS

In the asexual reproduction of *Stigeoclonium* the production of zoospores is confined to the erect system, and in that of *Draparnaldia* and *Draparnaldiopsis* to the lateral branches. Zoospores are usually quadriflagellate.

The sexual cycles of the Chaetophorales are not well known. Both isogamy and anisogamy have been reported, and *Aphanochaete* is oogamous. Motile gametes have been described as both biflagellate and quadriflagellate. Zygotes are commonly bright orange, and meiosis is believed to occur on germination.

Pleurococcus has no known method of reproduction other than simple cell division.

The morphological diversity of the Chaetophorales, and the restricted knowledge about their life cycles, make it difficult to assess their relationships with other green algae. Isolated specialized forms, such as *Draparnaldia* and *Aphanochaete*, are a conspicuous feature of the order. Although the cells of the Chaetophorales usually contain only a single basin-shaped chloroplast, their growth forms perhaps foreshadow later developments in plant evolution. The heterotrichous habit, for example, well developed in some genera, is also a feature of the gametophytes of many bryophytes (see Chapter 5).

The Oedogoniales

The Oedogoniales are a well-defined order, possessing several unique features. Some have attached so much weight to these as to consider that the order should be removed from the Chlorophyta. The Oedogoniales are not, however, anomalous in such fundamentals as wall structure and pigmentation, and they are probably better regarded as a small group that has diverged from the main line of evolution, the intermediate stages being no longer represented. The Oedogoniales comprise only three genera, *Oedogonium*, *Oedocladium* and *Bulbochaete*. Of these, *Oedogonium* is by far the commonest and best known.

THE THALLUS

The thallus of *Oedogonium* is an unbranched filament (Fig. 3.14). When young, the filaments are attached by a basal holdfast, but unless the water

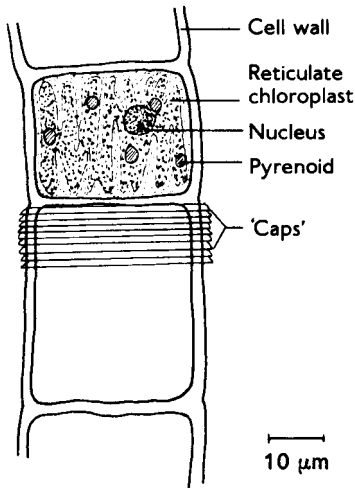

Figure 3.14 *Oedogonium* sp. Portion of filament.

they inhabit is flowing, the mature condition is free-floating. The individual cells have a single, large nucleus, and a reticulate chloroplast. Pyrenoids are frequent at the interstices of the reticulum. Cell division is normally intercalary, but the way in which the new cell walls are produced is highly peculiar (Fig. 3.15). The first indication that a cell is about to divide is the formation of a ring of wall material toward the upper end of the cell, just below the septum. The nucleus then divides and a septum forms between the daughter nuclei, but this septum remains free at the periphery. During the division of the nucleus the ring in the upper part of the cell becomes larger and crescent-shaped in vertical section. Eventually the cell wall breaks transversely at this level, and the ring is drawn out longitudinally to form a cylinder of new wall material. Meanwhile the septum between the nuclei moves up the cell, reaches the bottom of the newly formed cylinder, and then fuses peripherally with the longitudinal walls. The wall of the lower cell is thus largely that of the mother cell, while that of the upper, except for a conspicuous cap of original wall at the anterior end, is wholly new. The presence of caps, which if the daughter cell goes on dividing may be several in number, at the anterior ends of the cell is a feature diagnostic of the Oedogoniales.

REPRODUCTION

Both asexual and sexual reproduction occur in *Oedogonium*. Asexual reproduction is by means of zoospores which, like others of the Oedogoniales, are remarkable in possessing an apical ring of many short flagella (and are termed *stephanokont*). They arise singly in cells at various sites along the filament. While in the sporangium the zoospore is surrounded by a mucilage sheath giving the wall a characteristic two-layered appearance. The zoospore is released by rupture of the sporangium, thereby causing a break in the filament. It emerges still surrounded by mucilage, but this is soon shed and the zoospore becomes almost spherical (Fig. 3.16a). After a brief motile phase the zoospore settles and irregular rhizoid-like outgrowths from the flagellate end attach it to the substratum. A new filament then develops.

Both monoecious and dioecious species of *Oedogonium* are known. Large, almost spherical, oogonia are produced within the filament from the upper cell of a vegetative division. The lower cell may divide again, and another oogonium develop, but more usually it remains as the supporting cell. A single, dense, oosphere is formed in each oogonium (Fig. 3.16b). The oosphere shrinks away from the cell wall, and develops a colorless receptive spot as it matures. When it is fully mature, a pore appears at the anterior end of the oogonium adjacent to the receptive spot of the oosphere. The mature oogonium is commonly surrounded by mucilage.

Antheridia are produced by division of a vegetative cell into several disk-shaped portions, each of which produces two (in some species, four) pale green male gametes. These are similar, in both morphology and method of liberation, to the zoospores. Liberated gametes are attracted chemotactically to mature oogonia. Following fertilization the zygote forms an oospore, often reddish in color and regularly surrounded by a thickened wall.

In some dioecious species the male and female filaments differ morphologically, and the male may even be reduced to a minute individual epiphytic upon the female. In these nannandrous species the dwarf males arise from the female plants by way of a special propagule called an *androspore*. This is produced in a manner similar to

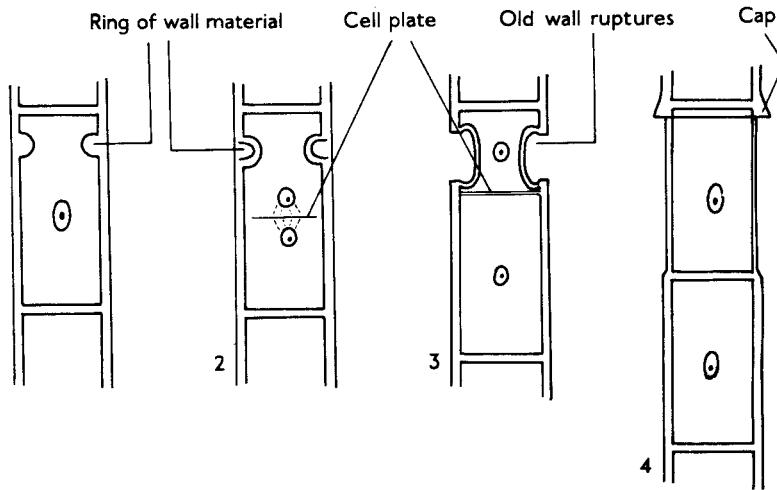
**Figure 3.15** *Oedogonium*.

Diagrammatic representation of stages in cell division.

settles to produce a new plant. In experimental conditions unchilled oospores have been germinated to give rise directly to a single filament with very large cells. Oogonia and antheridia are produced, but fertilization has not been observed. It seems likely that these giant forms are produced without meiosis, the nuclei consequently contain-

ing twice the normal number of chromosomes. They provide an example in the algae of the asexual production of a gametophyte.

In laboratory cultures the sexual phase can be induced by increasing the carbon dioxide concentration of the medium. With dioecious species it is also necessary to intermix male filaments with female to stimulate the production of oogonia. The secretion of hormone-like substances into the medium seems indicated (cf. *Volvox*, p. 44). In axenic cultures gametes are rarely produced, but the development of reproductive cells is notably increased if bacteria (e.g., *Corynebacterium* or *Pseudomonas putrida*) are present in the culture.

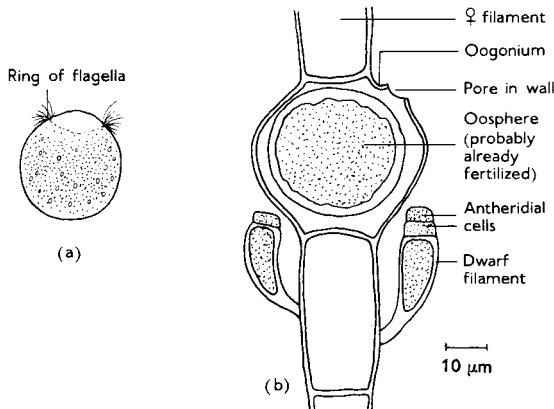

Figure 3.16 *Oedogonium* sp. (a) Zoospore. (b) Oogonium with adjacent dwarf males.

that of the male gametes, except that only one androspore is produced per cell. Resembling zoospores, except for their smaller size and yellowish color, the androspores are attracted chemotactically to the oogonium and its supporting cell. Here they settle and give rise to small filaments (Fig. 3.16b). After a few cells have been produced, antheridia are cut off, and reproduction proceeds as in the isomorphic (macrandrous) species.

Although oospores are sometimes able to germinate immediately, a long resting period seems generally to be necessary. There is evidence that chilling hastens germination. When growth is eventually resumed, the normal course is for four haploid protoplasts to be extruded, each of which develops a crown of flagella, swims away, and

RELATIONSHIPS

Related to *Oedogonium* are *Bulbochaete* and *Oedocladium*. *Bulbochaete* resembles *Oedogonium* in essentials, but the filaments are branched and terminate in hairs. In *Oedocladium* the filaments are both branched and form a heterotrichous system.

The affinities of the Oedogoniales are obscure. The hairs of *Bulbochaete* and the heterotrichous system of *Oedocladium* recall features of the Chaetophorales, and perhaps indicate a distant relationship. Another feature in common is the peripheral girdle-shaped chloroplast in each cell. The small gamete-like zoospores of some Chaetophorales may indicate the origin of nanandry in some Oedogoniales. Multiflagellate zoospores occur elsewhere only in some siphonaceous algae (e.g., *Derbesia*, p. 58), but a close relationship seems unlikely here.

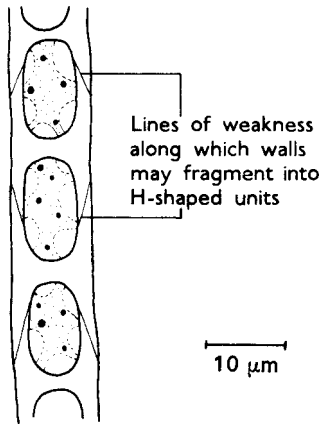

Figure 3.17 *Microspora pachyderma*. Portion of filament. (After West and Fritsch. 1927. *A Treatise on the British Freshwater Algae*. Cambridge University Press, Cambridge.)

The Sphaeropleales

The small order Sphaeropleales is also included in the Chlorophyceae. It includes the distinctive genus *Microspora*. The filaments, free-floating at maturity, are encountered in freshwater lakes and meres. The cells contain a reticulate chloroplast lacking pyrenoids. The cell walls disjoin in characteristic H-shaped pieces when the filaments fragment (Fig. 3.17). Asexual reproduction (other than by fragmentation) is by bi- or quadriflagellate zoospores. Sexual reproduction is isogamous, the gametes being biflagellate. The site of meiosis in the cycle appears not to have been determined.

Ulvophyceae

The orders grouped into this class show a great diversity of habit ranging from the filamentous to the siphonaceous.

The Ulotrichales

Amongst the filamentous forms are the Ulotrichales. *Ulothrix* itself has a simple filament lacking branches. The genus has species in both fresh and saline waters. When mature the filaments form loose, free-floating bundles. All the cells are of equal status, except the basal attachment cell usually present in young filaments. The vegetative cells, which are often wider than long, are uninucleate and have a single girdle-like, peripheral chloroplast (Fig. 3.18a), containing many pyrenoids. Cell divisions are sporadic and

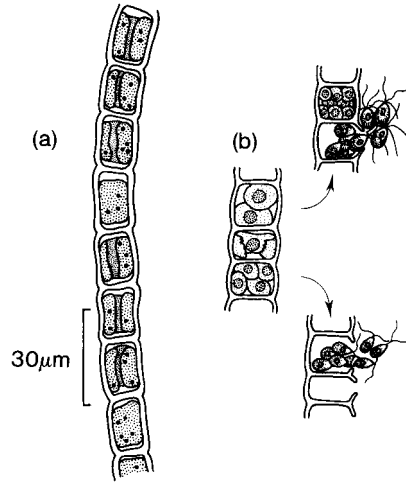

Figure 3.18 *Ulothrix zonata*. (a) Vegetative filament showing the girdle-shaped chloroplast. (b) Above, production of quadriflagellate zoospores; below, production of gametes (diagrammatic).

intercalary. Fragmentation of the filament is common, but this is caused principally by accidental breakage; simultaneous dissociation of the filament into segments has rarely been observed.

REPRODUCTION

High temperatures stimulate asexual reproduction, 1–32 zoospores (the number depending upon the species) being produced in each cell by division of the protoplast. The mature zoospores are pear-shaped and quadriflagellate (macrozoospores) (Fig. 3.18b above). In some species smaller biflagellate zoospores (microzoospores) are also produced, intermediate in size between macrozoospores and gametes. The zoospores are liberated through a pore in the wall of the parent cell, each zoospore surrounded by a mucilaginous sheath. The free zoospore closely resembles a unicellular member of the Volvocales, devoid of its cell wall. After settling, the zoospore attaches itself by the posterior end (to which the stigma has now shifted), and grows out laterally, producing a holdfast cell on one side, and new vegetative cells on the other. Sometimes, after the initial division in the parent cell in a filament, aplanospores with resistant walls are produced instead of zoospores.

Long days initiate sexual reproduction. Gametogenesis resembles the production of zoo-

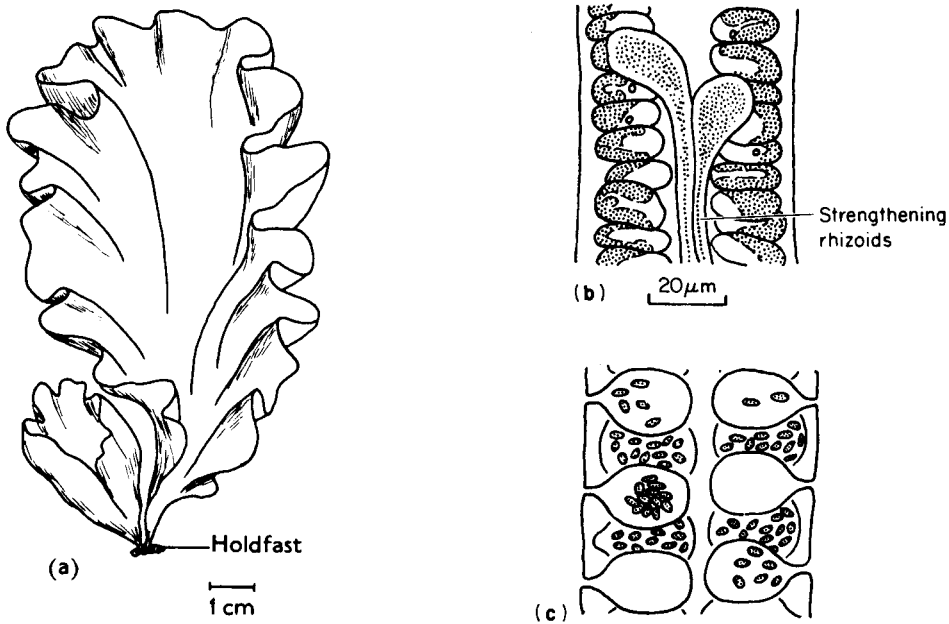

Figure 3.19 *Ulva lactuca*. (a) Habit. (b) Transverse section of vegetative thallus. (c) Transverse section of thallus producing zoospores. ((a), (c) after Newton. 1937. *A Handbook of the British Seaweeds*. British Museum, London; (b) after Thuret, from Fritsch. 1935. *The Structure and Reproduction of the Algae*, vol. 1. Cambridge University Press, Cambridge.)

spores in asexual reproduction. The gametes, however, are uniformly biflagellate, and 8, 16, 32 or 64 (the number again depending upon the species) are produced in each gametangium (Fig. 3.18b below). *Ulothrix* is physiologically heterothallic, gametes from the same filament being unable to unite. The zygote retains four flagella and is mobile for a short while, but is negatively phototactic. Having settled, it then secretes a resistant wall and enters a resting period during which it may become attached and form a small unicellular plant. Germination, occurring in short-day conditions, commences with meiosis, at which the mating types are segregated. Meiosis is followed by one or two mitoses and the formation of zoospores or aplanospores. The diploid state is thus represented only by the zygotic cell and has no prolonged existence. According to some accounts the biflagellate swimmers are exclusively gametic.

Monostroma is also currently classified with the

Ulotrichales. Although beginning life as a filament, lateral divisions also occur so that the mature plant (which is gametophytic) has a flat, leaf-like thallus, uniformly one cell thick, attached to the substratum by a holdfast. Some species are notable for being able to tolerate great changes of salinity in, for example, estuarine conditions. In the life cycle of *M. grevillei* (a species of north temperate coasts) the gametes are biflagellate and copulation anisogamous. The zygote settles to form a small unicellular plant which becomes attached to the substratum by rhizoids. Germination is as in *Ulothrix*, quadriflagellate zoospores being released after meiosis and a number of mitoses.

The Ulvales

The Ulvales contain forms ranging from branching filaments to expanded thalli. *Ulva*, for example, has a foliaceous thallus, very similar to that of *Monostroma*, but in *Ulva* two cells thick (Fig. 3.19). Each cell, as in the Ulotrichales, contains a single chloroplast. At cell division each chloroplast divides at the same time as the nucleus. *Ulva* was the first multicellular plant in which it was possible to follow unambiguous chloroplast division with the electron microscope.

Young plants of *Ulva* always begin their

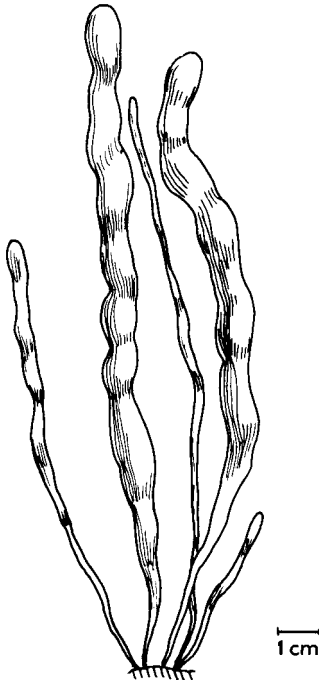

Figure 3.20 *Enteromorpha intestinalis*. The thallus consists of hollow thin-walled cylinders. (After Newton. 1937. *A Handbook of the British Seaweeds*. British Museum, London.)

development as simple filaments. Division in principally two dimensions results in a flattened expanse of tissue expanding from a narrow stalk and holdfast (Fig. 3.19a). Some of the holdfast cells produce multinucleate rhizoids which grow between the two cell layers, strengthening the thallus (Fig. 3.19b). These are most evident adjacent to the stalk. Mutants are known which remain filamentous, the cells having lost the ability to divide in more than one direction.

The marine intertidal zone is the characteristic habitat of both *Ulva* and the closely related *Enteromorpha* which has a peculiar tubular thallus (Fig. 3.20). Both species, like *Monostroma*, can tolerate wide variations in salinity, and may be found far up tidal estuaries.

REPRODUCTION

Asexual reproduction occurs in a number of species in the same manner as in *Ulothrix*, most of the vegetative cells taking part (Fig. 3.19c). Zoospores may be biflagellate or quadriflagellate. After zoospores have been discharged, the parent

thallus often remains as a bleached framework of empty cells.

Sexual reproduction is again similar to that of *Ulothrix*, and *Ulva* is also physiologically heterothallic. The gametes of the two mating strains differ slightly in size. The zygote, however, does not undergo reduction division on germination, but grows instead into a diploid thallus identical with that of the haploid plant. The cycle is thus isomorphic. The production of quadriflagellate zoospores in cells toward the border of the blade is accompanied by meiosis (although there are some irregularities). Equal numbers of both mating strains are produced.

Laboratory cultures of *Ulva* have revealed subtle controls of fertility. Axenic cultures reproduce rarely or irregularly. A glycoprotein isolated from old medium suppresses sporulation at very low concentrations. Also a "swarming inhibitor", produced during gametogenesis, appears to regulate and synchronize gamete release. In culture the gametes of the + strain of *U. mutabilis* can be made to grow into "parthenosporophytes". These mostly diploidize during development, and produce zoospores by normal meiosis. The gametes of the - strain do this far less readily. Meiosis is attempted, but the chromosomes are irregularly distributed and the viability of the products very low.

The life history of *Enteromorpha* resembles that of *Ulva*. An isomorphic cycle is also shown by the branching filamentous *Acrochaete*, which grows on, or in, the tissues of larger marine algae (e.g., *Chondrus crispus*, p. 33). Here, however, the gametes of the two mating strains are produced in different gametangia on the same plant.

There are no intermediate forms in the Ulvales indicating how an isomorphic life cycle, such as that of *Ulva*, might have originated. It is possible that a relatively simple mutation prevented meiosis at the zygotic stage, and that the inhibition remained effective until after many cell generations. Since there is no evidence that chromosome number itself determines the form of growth in any group of plants, this delaying of mitosis would have allowed the development of a diploid thallus closely resembling that of the haploid. In the evolution of *Ulva* the emergence of a distinct sporophyte was probably accompanied

by the progressive elaboration of the vegetative structure of both phases of growth. The experimental evidence from *Oedogonium* (p. 51) indicates that suppression of meiosis alone is not adequate to establish an isomorphic life cycle.

The Prasiolales

Prasiola, usually placed with, or near, the Ulvales, is a familiar plant on tidal rocks and shore lines, particularly where the substrate is rich in nitrogen (for example from bird droppings or seal excrement). The thallus resembles a small *Ulva* in form and attachment, but is only one cell thick. The non-sexual plant reproduces itself by spherical spores (aplanospores) produced from the distal part of the thallus. In the sexual plant the distal portion of the thallus is the site of meiosis. The haploid cells so produced then undergo several mitoses, building up groups of haploid cells within the diploid thallus. Each group of cells ultimately differentiates into gametes, either biflagellate males or non-flagellate females. A gametophytic phase thus exists for some time within the confines of the sporophyte.

The fusion of a male and female gamete takes place progressively. For a time one male flagellum remains extruded and the zygote is motile. Ultimately there is total absorption and a walled zygote is formed. Little is known about germination and the early development of the sporophyte. Sexual reproduction tends to predominate in the plants lower in the intertidal belt and asexual reproduction in those higher up.

Terrestrial species allied to *Prasiola* are found near the base of north-facing (and permanently damp) walls in the older parts of towns in the west of Ireland. This distribution appears to be influenced by the sites being occasionally irrigated with urine.

The Cladophorales

The remainder of the Ulvophyceae are characterized by multinucleate cells. The simpler are placed in the order Cladophorales. All are filamentous. *Cladophora* itself has some 160 species, some marine and others freshwater. The filaments show true branching, buds developing toward the anterior end of the elongated, cylindrical vegetative cells (Fig. 3.21). The bundle of filaments is usually

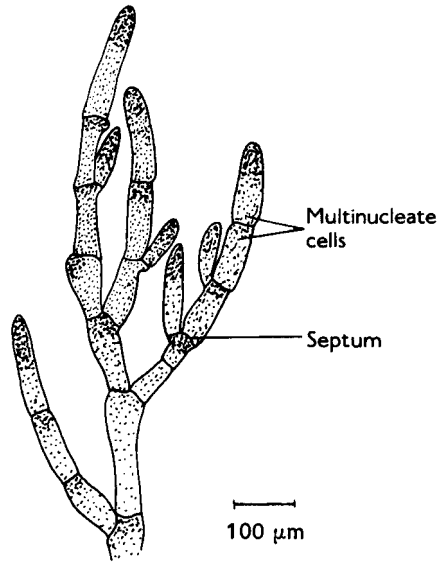

Figure 3.21 *Cladophora* sp. Upper part of the thallus showing characteristic branching and the greater density of the cytoplasm toward the apical ends of the cells.

attached below by a rhizoid-like cell to a firm surface in the substratum. The internal structure of the cells is complex, each cell being multinucleate and having many small angular chloroplasts, apparently interconnected by fine threads, forming a parietal network. In many species each chloroplast has a single, more or less spherical pyrenoid, transected at the equator by a single thylakoid. The cell wall comprises three layers, the inner one of cellulose (the microfibrils of which are arranged in bands of alternating orientation), a central layer of hemicellulose, and finally an outer coating, containing up to 70 percent protein and possibly chitinous, which gives the alga its characteristic crisp feeling. It also provides a surface which is rapidly colonized by small epiphytes, notably diatoms. Division of the protoplast, which is not regularly related to nuclear division, is accompanied by the formation of transverse septa. These develop from the margin toward the center, and gradually acquire a complicated lamellate structure at the periphery, which may impart some flexibility to the older filaments. Growth of the filaments is apical in *Cladophora*, but intercalary growth is general elsewhere.

A curious feature exhibited by some species of

Cladophora and certain other genera is the tendency, when subjected to a gentle rolling motion in water, to aggregate into cushions or spheres. These are termed “aegagropilous” species because of the fancied resemblance of these aggregates to the balls of wool found in goats’ stomachs. *Cladophorella*, a plant of damp places, is of interest because its upper cells secrete what appears to be a true cuticle, possibly a forerunner of that found in the land plants.

REPRODUCTION

Both the asexual and sexual reproduction of the Cladophorales resemble that of *Ulothrix*. The zoospores and gametes are produced in non-specialized cells, and copulation is usually isogamous, rarely anisogamous. Fusion of the biflagellate gametes is lateral. The zoospores produced meiotically by the sporophyte are quadri-flagellate. An isomorphic life cycle has been demonstrated in some species, but in others the cycle is heteromorphic. Before these were understood the gametophytic and sporophytic phases, being unrecognized, were assigned to separate genera.

Vegetative reproduction by fragmentation of branches also occurs, and seems to be the sole means of reproduction of the aegagropilous species. In some species survival through unfavorable periods is afforded by the formation of thick-walled resting spores packed with food reserves.

The Siphonales

The more complex Ulvophyceae with multinucleate cells are all siphonaceous. In current classifications the siphonaceous algae are distributed amongst several orders (see Table 2.1), but they can be conveniently considered together (“Siphonales”). The thalli normally contain multinucleate protoplasts and are consequently termed *coenocytic*. Dividing walls are largely absent until the formation of the reproductive organs. The range in form of the thallus is considerable: it may consist of a simple unbranched tube or a complex mass of interwoven filaments. Those species with complex thalli are invariably marine, and the thalli are often mechanically strengthened by

superficial deposits of calcium carbonate. There are numerous chloroplasts, and in some species they have particularly tough envelopes. They can remain functional following ingestion by marine invertebrates. The siphonaceous algae also differ from the rest of the Chlorophyta in containing both α - and β -carotene, instead of β -carotene alone, and at least one additional carotenoid (siphonoxanthin). Almost all are confined to tropical or warm seas. The classification of the Siphonales undergoes periodic revision as more is discovered about their remarkable life histories.

Dichotomosiphon (**Dichotomosiphonales**) is filamentous with a superficial resemblance to *Vaucheria* (p. 79). It is aquatic and has been found at depths of up to 15m (50ft) in fresh water. *Valonia* (**Siphonocladales**) is marine and consists solely of a bladder-like cell reaching a few centimeters in diameter. It often bears clusters of daughter vesicles, and short basal branches from a rhizoid-like holdfast. *Valonia* has been extensively used in experiments on wall structure, permeability and absorption of electrolytes.

Acetabularia (**Dasycladales**) (Fig. 3.22) has a mushroom-shaped thallus when mature, the cap reaching a diameter of about 1cm (0.4in.). The whole delicate plant is stabilized by a shell of calcium carbonate. The central axis produces whorls of deciduous branches during growth. Unlike most of the siphonaceous algae, *Acetabularia* is uninucleate throughout its vegetative development, the nucleus, large and conspicuous, remaining at the base of the stalk. It has been found that if the stalk is removed from the nucleate portion the stalk remains capable of some growth and the apex may even begin to form a cap. Nevertheless the nucleus is clearly essential for continued growth and complete morphogenesis. Decapitation and grafting experiments have shown that the nucleus produces a sequence of “morphogenetic substances” (now known to be messenger RNAs) which ascend into the stalk and determine the kind of growth which occurs at the top. The RNAs appear to be masked at transcription and to become activated in an appropriate succession. Grafts made between the stalk of one species and the nucleate portion of another have revealed that the cytoplasm of the

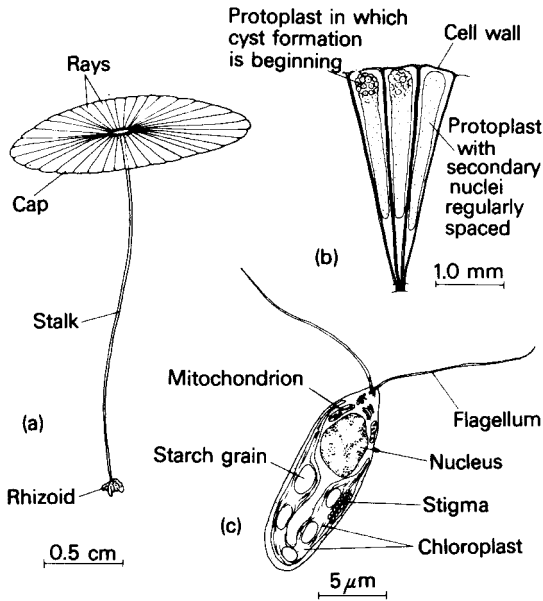

Figure 3.22 *Acetabularia mediterranea*. (a) Cell with mature cap. (b) Detail of cap during cyst formation. (c) Longitudinal section of gamete.

first species can affect the expression of the genetic information contained in the nucleus of the second. Growth and development are dependent upon blue light, and indole-3-acetic acid (IAA), abscisic acid, and ethylene are also involved in differentiation.

As the chloroplasts replicate in the growing plant, their content of DNA becomes less uniform and in some undetectable by cytological techniques. The fructosan inulin has been reported as a reserve polysaccharide *in vivo*. The mature chloroplasts can be isolated comparatively easily. They were the first with which it was possible to demonstrate normal photosynthesis *in vitro*.

The **Codiales** show a considerable advance in vegetative organization. The thallus of *Bryopsis* (Fig. 3.23), for example, possesses a main axis, from which branches arise pinnately. These also branch, leading to a complanate bipinnate, and in some species tripinnate, condition. At the insertion of each branch the cell walls are constricted and conspicuously thickened. This feature undoubtedly has mechanical signifi-

cance, since a simple branched tube lacking septa and with walls of uniform thickness would become structurally unstable beyond a certain point. In the vegetative condition the cytoplasm is spread as an even layer containing numerous nuclei and chloroplasts. The frond-like thallus of *Bryopsis* rises more or less vertically and is anchored to the substratum by rhizoids produced from a small prostrate filament. Fragments of the thallus will regenerate as new plants, but rhizoidal outgrowths are formed only from the morphologically lower end. This is an example of polarity, widespread in the plant kingdom, but particularly open to investigation in *Bryopsis* because of its occurrence in a relatively simple unicellular system. *Derbesia* is a plant of warmer seas. Here there is a distinct "rhizome" attached to the substratum by lobed holdfasts and producing from its upper surface branching tubular threads.

Codium (Fig. 3.24) has a wider distribution and extends into cooler seas. It is representative of the most elaborate vegetative organization found in the siphonaceous algae. The thallus is made up of closely packed interwoven filaments (hyphae), although the outward morphology varies widely with species. In *C. tomentosum* the thallus is a system of dichotomously branched axes, each about 0.5 cm (0.2 in.) in diameter, anchored at the base. Other species are flattened, forming a cushion or plate, or spherical. In all species a web of branched filaments gives rise to a continuous covering of elongated vesicles at the exterior.

Caulerpa (**Caulerpales**) has an extensively creeping "rhizome" from which both rhizoids and upright "fronds" arise (Fig. 3.25). The "fronds" show a great variation in shape when mature, different species having been named from their distinctive forms (Fig. 3.26). Internally, all species of *Caulerpa* show ingrowths of the cell wall forming, throughout the thicker portion of the thallus, a web of interconnecting bars. This adds to the mechanical stability of the thallus, and the increased surface area of the protoplast may facilitate the passage of minerals. The fibrillar polysaccharide of the wall is not cellulose but a β -1,3 xylan, a polymer of a pentose sugar. The walls also

Figure 3.23 *Bryopsis plumosa*. (a)

Habit. (b) Terminal portion of branch. (After Newton, 1937. *A Handbook of the British Seaweeds*. British Museum, London.)

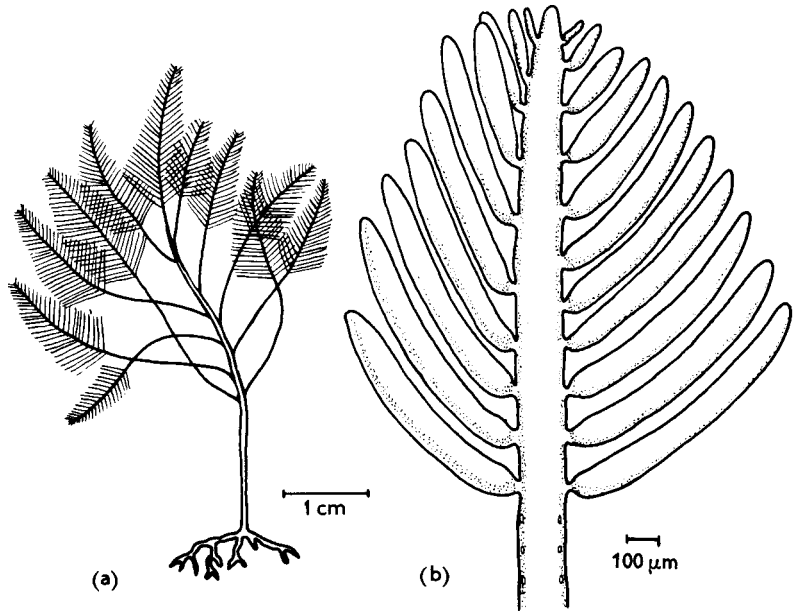

contain callose, a β -1,3 glucan, also found in the sieve tubes and reproductive structures of land plants. *Caulerpa* is found in temperate seas. *Caulerpa taxifolia* is currently showing an aggressive spread in parts of the Mediterranean. *Halimeda* (Fig. 3.27) is a related tropical alga with a complex thallus of variable morphology. Calcium carbonate is deposited in the side walls of the outer vesicles. These deposits survive after the death of the plant and yield one of the several forms of coral. In the cells of the Caulerpales generally chloroplasts and amyloplasts are both present. *Udotea*, a genus represented by several species in tropical and subtropical seas and similar in structure to *Codium*, provides a possible example of the C4 photosynthetic pathway (p. 6) in the algae.

REPRODUCTION

Although *Derbesia* produces stephanokont zoospores (resembling those of *Oedogonium*), all other siphonaceous algae appear to lack specialized means of asexual reproduction. In *Valonia*, for example, vegetative multiplication takes place by the sporadic detachment of the daughter vesicles. In the larger forms segments, branches or parts of the "rhizome" become detached and establish themselves as new plants. In *Codium* and *Caulerpa* this seems to be the principal method of reproduction.

The sexual cycles of many Siphonales are still obscure. In general it appears that reproduction is isogamous or anisogamous, and oogamy absent. In species of *Bryopsis* terminal pinnae, normally the smallest, become transformed into gametangia and are cut off from the rest of the thallus by a septum. The gametangia are conspic-

uously opaque as a consequence of the considerable multiplication of plastids. The gametes are liberated by dissolution of the apex of the gametangia. They are biflagellate, but there is striking anisogamy and, since each plant usually produces gametes of only one size, a clear trend to dioecy. The larger gametes (regarded as female) also contain a distinctly green plastid, whereas the smaller (male) gametes are yellowish. The nuclei of the gametes and those of the parent thallus (referred to as the *macrothallus*) contain the same amount of DNA, so the macrothallus is clearly haploid. After fusion the zygote develops immediately into a branching filament (*microthallus*) with a single, very large, nucleus. This subsequently undergoes successive divisions, leading to many small secondary nuclei, dispersed throughout the filament. At some stage meiosis occurs, following which the microthallus either liberates stephanokont zoospores, or segregates fragments which, like the zoospores, grow into new gametophytic plants. Field observations indicate that the course and the timing of the reproductive cycle are readily influenced by local environmental factors.

Although sexual reproduction in *Codium* and *Caulerpa* is probably basically similar to that in *Bryopsis*, meiosis has been detected during gamet-

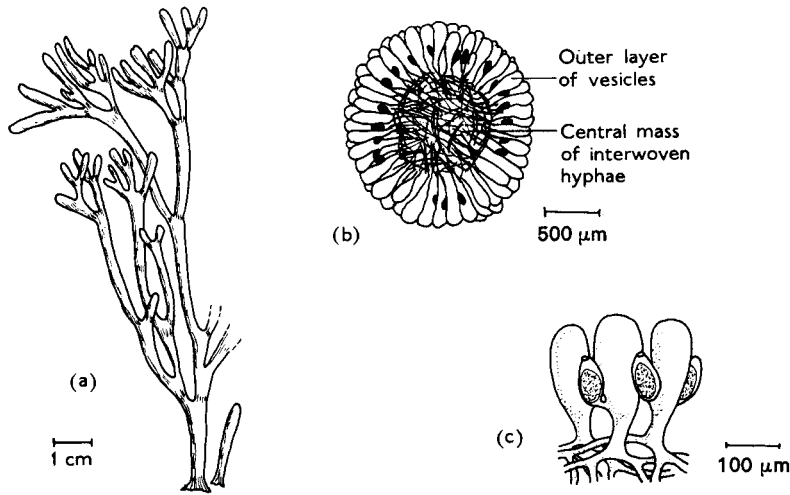

Figure 3.24 *Codium tomentosum*.

(a) Habit. (b) Transverse section of thallus. (c) Gametangia. (After Newton, 1937. *A Handbook of the British Seaweeds*. British Museum, London.)

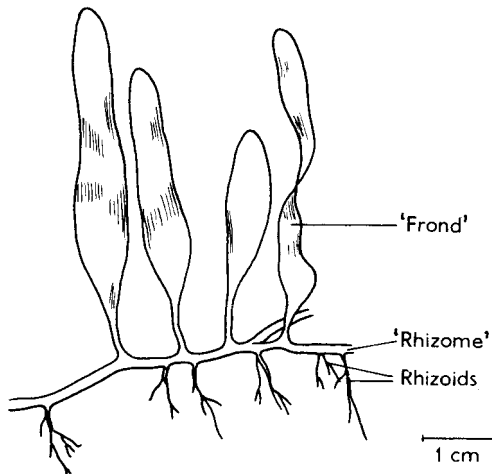

Figure 3.25 *Caulerpa prolifera*. Portion of plant. (After Taylor, 1960. *Marine Algae of the Eastern Tropical and Subtropical Coasts of the Americas*. University of Michigan Press, MI.)

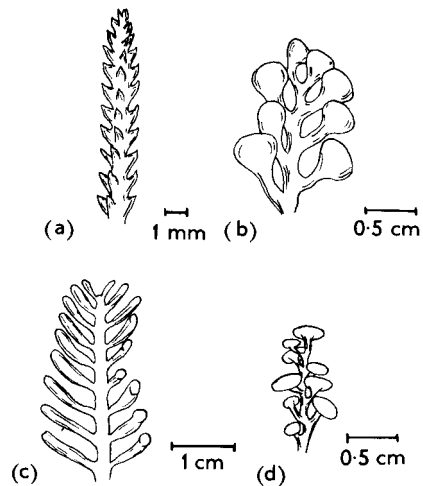

Figure 3.26 *Caulerpa*. Types of "fronds". (a) *C. cupressoides*. (b) *C. racemosa* var. *macrophysa*. (c) *C. asmeadii*. (d) *C. peltata*. (After Taylor, 1960. *Marine Algae of the Eastern Tropical and Subtropical Coasts of the Americas*. University of Michigan Press, MI.)

ogenesis in the macrothallus. The thallus in these forms is therefore presumably diploid. The complete life cycle has yet to be clearly resolved.

The life cycle of *Acetabularia* is now well understood, and proves to have many curious features. During vegetative growth the chromosomes in the single nucleus at the base of the stalk undergo continued endoreplication, the nucleus increasing its volume by a factor of about 20000, and reaching a diameter of at least 100 μm . The

number of nucleoli also increases. The portions of chromosomes lying within the nucleoli actively transcribe ribosomal RNA, and the familiar "Christmas trees" formed by the growing RNA molecules can be readily demonstrated by spreading techniques and electron microscopy (Fig. 3.28). When growth of the giant basal nucleus is completed, it divides into several thousand secondary nuclei. These ascend into the cap,

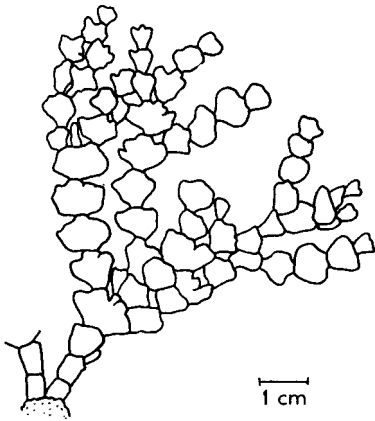

Figure 3.27 *Halimeda simulans*. Portion of thallus. (After Taylor. 1960. *Marine Algae of the Eastern Tropical and Subtropical Coasts of the Americas*. University of Michigan Press, MI.)

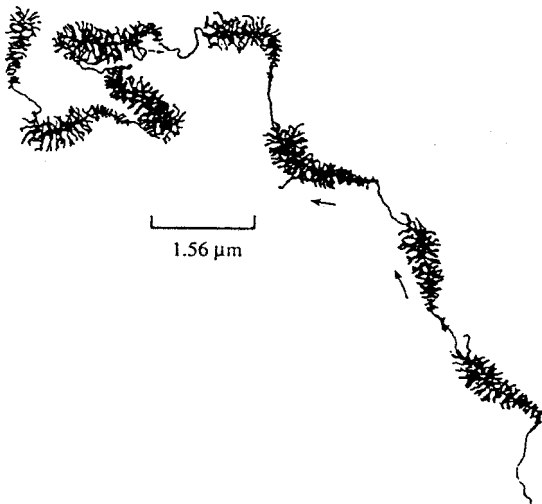

Figure 3.28 *Acetabularia*. Segment of chromosomal DNA in the nucleolus of the giant nucleus. Ribosomal RNA is being actively transcribed in the direction of the arrows, giving the familiar "Christmas tree" formation. The actively transcribing regions of the DNA are separated by inactive "spacers". (From Schweiger, Bannwarth, Berger and Kloppstech, in Puseux-Dao (ed.) 1975. *Molecular Biology of Nucleocytoplasmic Relationships*, pp. 203–12. Elsevier, Amsterdam.)

which by this stage has reached its mature size. The cap now becomes cleft into uninucleate compartments. Each compartment becomes a cyst, bounded by a thickened wall, from which biflagellate gametes are ultimately liberated (Fig. 3.22b

and c). Although the gametes are morphologically identical, their pairing behavior indicates the presence of + and – mating strains, a situation recalling that already encountered in *Chlamydomonas*. The site of meiosis was for long uncertain, but more recent observations, based upon microspectrophotometric measurements following Feulgen staining, of relative amounts of DNA in the nuclei point to meiosis occurring at division of the large primary nucleus. Following gametogenesis and gametic fusion, the zygote begins to develop immediately into the familiar unicellular and uninucleate plant; the primary nucleus is therefore the only diploid stage in the life history.

The existence of a heteromorphic life cycle has been confirmed in *Derbesia*. Zoospores from some species of *Derbesia* have been observed to grow into vesicular plants reaching about 1 cm (0.4 in.) in diameter formerly placed in the genus *Halicystis*. These are now known to be gametophytic. Zygotes formed from the fusion of biflagellate gametes have yielded *Derbesia*. Other species of *Halicystis* may be gametophytes of *Bryopsis* whose sexual cycles have not yet been fully investigated. There are many indications that surprising discoveries may yet be made about the life cycles of the siphonaceous algae.

RELATIONSHIPS

The relationships of the siphonaceous algae are obscure, but the origin may have been in a form resembling the present Chlorococcales, an order in which tendencies toward the coenocytic habit are evident. An ancestor may have been a simple coenocyte resembling *Protosiphon* (p. 45). Lime-secreting siphonaceous algae are clearly ancient; their fossil record goes back as far as the Cambrian (see Table 1.1), where evidence may be found for the existence of both the Codiales and the Dasycladales. *Palaeoporella* from the late Cambrian, for example, was a lime-producing form similar to *Halimeda* (Fig. 3.27). Fossil siphonaceous algae are particularly abundant from the Ordovician, when they must have formed a significant component of the marine benthic flora. Typical of these was the *Acetabularia*-like *Coelosphaeridium* with numerous radiating branches.

Charophyceae

This class contains unicellular, filamentous and heterotrichous forms. Of particular interest are metabolic and structural features which resemble those found in higher plants. In the non-mitochondrial part of respiration, for example, the enzyme glycolate oxidase, characteristic of land plants, replaces glycolate dehydrogenase present elsewhere in the Chlorophyta. During cell division in the Charophyceae the nuclei tend to move well apart in telophase, and the spindle to persist. In some members the new transverse wall forms from coalescing vesicles at the equator in the manner in which the phragmoplast functions in higher plants. This contrasts with the situation in the Chlorophyceae (p. 41). A significant feature in the reproductive cells of some species is an array of minute plates and microtubules at the root of the flagella (Fig. 3.35) in zoospores and gametes, very similar to the multilayered structure found in archegoniate spermatozoids (p. 104). Although these features may have arisen more than once in the course of evolution, they have drawn particular attention to the Charophyceae in relation to the question of the kind of algae from which land plants may have arisen.

Amongst the simpler filamentous forms is *Klebsormidium* (**Klebsormidiales**), most species of which occur in the soil. The cells are not unlike those of *Ulothrix*. Asexual reproduction occurs by means of biflagellate zoospores. Sexual reproduction is isogamous.

The unicellular members of the class fall into the orders Mesotaeniales and Desmidiiales.

The Mesotaeniales

The Mesotaeniales contain the so-called “saccoderm desmids”, the cell walls of which consist of only one portion of (so far as known) uniform age (cf. the “placoderm desmids”, see below). The cells contain two plate-like chloroplasts symmetrically placed on each side of the nucleus (Fig. 3.29). The cell walls are without ornamentation and lack pores. The cell sap is sometimes pigmented, and these desmids (mostly *Ancylonema*) are in part responsible for the “red snow” seen on alpine glaciers and in the Arctic. Saccoderm desmids also occur in bog pools.

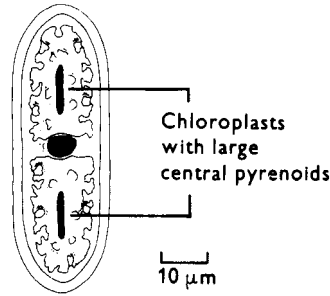

Figure 3.29 *Cylandrocystis brebissonii*, a saccoderm desmid occurring amongst *Sphagnum* in acid pools. The two prominent stellate chloroplasts are symmetrically placed in the cell and the nucleus lies between them.

REPRODUCTION

Asexual reproduction is by a simple division, several cells often being held together within a mucilage sheath. Sexual reproduction involves conjugation of two cells. Meiosis and division of the zygote into four daughter cells take place after a resting period. Mendelian segregation of mating type has been demonstrated in pure cultures.

The Desmidiiales

Most of the desmids are referable to the order Desmidiiales (the “placoderm desmids”). They are typically unicellular (although sometimes the cells may be aggregated in chains) and are conspicuous in the phytoplankton of oligotrophic meres. The cells have complex shapes and a precise and striking symmetry. In many forms the cell is divided into two halves, one being the mirror image of the other, connected by a narrow central portion, the *isthmus*. The nucleus usually lies in the isthmus, and one or more chloroplasts are present in each half cell. Even in those forms in which the central constriction is less conspicuous (e.g., *Cosmarium*, Fig. 3.30) or absent (e.g., *Closterium*) the cells still display exact bilateral symmetry. In *Closterium* the cells are narrowed toward the poles and slightly curved. There is a small vacuole at each pole. Crystals of barium sulfate are commonly found in the vacuoles even when the concentration of barium ions without is very low.

The cell wall is made up of an inner cellulose layer and an outer layer of variable composition, frequently containing iron compounds or silica. It

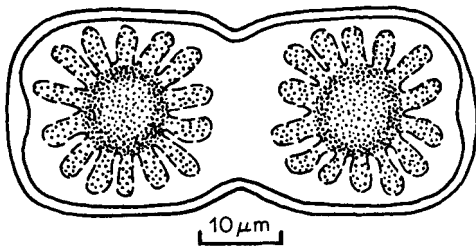

Figure 3.30 *Cosmarium diplosporum*, a placoderm desmid. (After West and Fritsch. 1927. *A Treatise on the British Freshwater Algae*. Cambridge University Press, Cambridge.)

is particularly this outer layer, often patterned with spines and other protuberances, which provides the specific characteristics, and which puts the desmids amongst the most beautiful of microscopic objects. The cells are frequently surrounded by an investment of mucilage secreted by minute pores in the wall. It is probably the localized secretion of such mucilage which enables the cells to perform slow movements.

REPRODUCTION

Asexual reproduction is by fission. The details of the process are not yet fully understood, but in outline it is as follows. After nuclear division a ring of wall material develops at the center of the isthmus and grows inward to form a septum. When complete, the daughter cells separate. Each then regenerates the missing half and the symmetry is restored (Fig. 3.31). This results in two adult organisms in each of which half of the thallus is inherited from the previous generation and the other half newly synthesized. This is an example of semi-conservative replication of an organism recalling that of the molecule of double-stranded DNA.

Sexual reproduction involves conjugation of cells. A protuberance may be formed from one cell and directed toward the other, but in many species the walls break down at the isthmus and the protoplasts emerge and fuse. Following fusion a thick-walled zygospore is formed. The wall appears to be basically cellulose, but callose and a sporopollenin-like substance may also be present. The resting zygotes (termed "hypnozygotes") are resistant to desiccation, and remain dormant for at least three months. In *Cosmarium*, which may be representative of the placoderm desmids gener-

ally, meiosis yields two binucleate cells, but one nucleus in each cell degenerates. The daughter cells, now uninucleate, are of opposed mating types. After a few mitotic cell divisions, the characteristic desmid shape is attained.

The Zygnematales

The thalli of the order Zygnematales consist of unbranched and free-floating filaments, although rhizoid-like outgrowths may attach the basal cell to the substratum in the young state. Almost all are found in fresh water.

The cells are often markedly elongate, having an axile ratio of 5:1 or more. The nucleus lies near the center suspended by cytoplasmic strands, and the conspicuous chloroplast is in the form of a flat plate (e.g., *Mougeotia*) or a helical band at the periphery of the cell (e.g., *Spirogyra*, Fig. 3.32), or it consists of two stellate portions (e.g., *Zygnema*). Numerous pyrenoids occur in each form of chloroplast. In strong light the chloroplast of *Mougeotia* turns so that its narrow edge is presented to the source. Experiments with polarized light have shown that the stimulus to this movement comes from an array of photoreceptive molecules at the periphery of the cytoplasm. The proteinaceous pigment phytochrome is also involved.

Growth of the filament is intercalary, all the cells except the basal cell being capable of division. The dividing wall grows in from the margin, but the central region of the septum is completed by the formation of a phragmoplast.

REPRODUCTION

Asexual reproduction is solely by fragmentation of the filament, and is preceded by changes in the transverse walls. In some species the middle lamella of the transverse wall becomes gelatinous and a turgor difference arises between the cells. This causes one cell to bulge into its neighbor and the junction between the cells becomes strained to breaking point. In other species a ring or collar of wall material forms on each side of the septum and in a manner not yet understood leads to separation. The comparative ease with which the cells separate has led some to regard the Zygnematales as basically unicellular.

Sexual reproduction involves conjugation, occurring normally toward the end of the

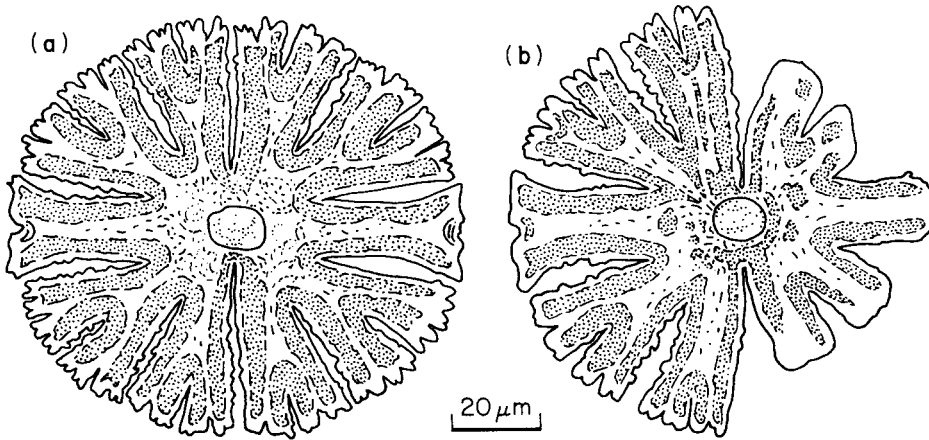

Figure 3.31 *Micrasterias*, a placoderm desmid. (a) Mature individual preparatory to division. (b) Following division, the beginning of regeneration of new half cell.

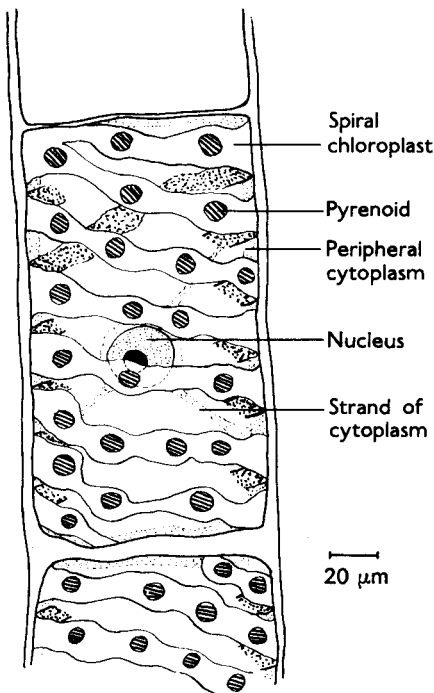
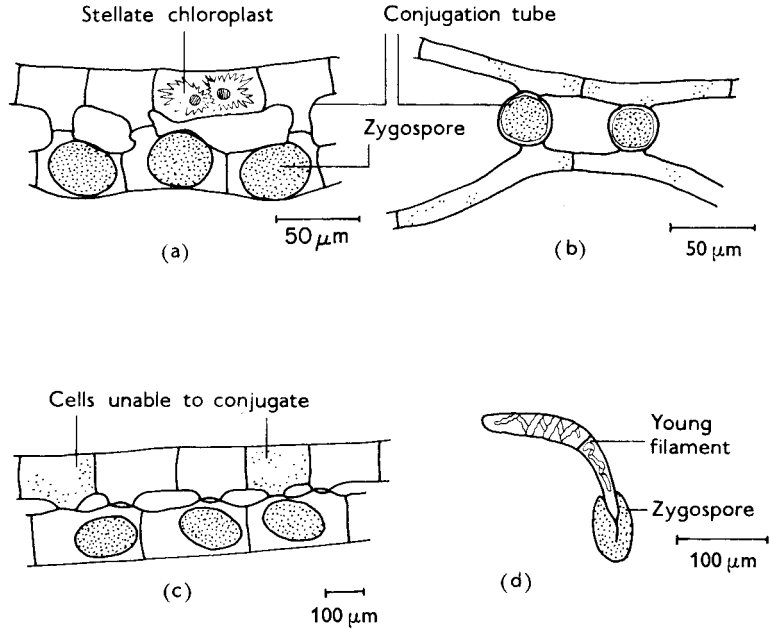

Figure 3.32 *Spirogyra* sp. Cytology of vegetative cell.

growing season, but factors such as nitrogen deprivation, pH, and altitude (presumably because of its relationship with mean temperature) have all been found to influence it. Before conjugation the two participating filaments must lie parallel and come close together (Fig. 3.33a). The necessary

adjusting movements are probably brought about by the localized secretion of mucilage. Since solitary filaments show no directed movement the first approach of one filament to another, presumably of opposed mating type, must involve some form of chemotaxis. Once alignment has taken place, further mucilage secretion holds the filaments in position and opposing cells begin to form protuberances directed toward each other. The production of protuberances is not necessarily simultaneous, and a cell may be touched by the protuberance of its partner before it has itself become active. The production of a similar structure is then immediately induced. The growth of the protuberances pushes the filaments apart at the site of conjugation. If an unmated protuberance touches a cell which has already formed a connection there is no further response (Fig. 3.33c). Eventually growth of the protuberances ceases, the opposed distal walls dissolve, and a conjugation tube is formed between the two cells. With the formation of the tube complex, physiological changes take place within the protoplasts. There is an increase in starch, and a decrease in permeability and the osmotic pressure of the cell sap. Before completion of the conjugation tube no sexual differentiation of the two protoplasts is apparent, but as soon as communication is established one protoplast withdraws from its wall, and passes slowly through the tube to fuse with its partner. Since all the protoplasts in one filament behave in the same way (Fig. 3.33c) it is legitimate to regard one filament as male and one as female. After

Figure 3.33 Sexual reproduction in the Conjugales. (a) *Zygnema stellinum*. (b) *Mougeotia parvula*. (c) *Spirogyra setiformis*. (d) *Spirogyra velata*, germination of zygospore. (After West and Fritsch. 1927. *A Treatise on the British Freshwater Algae*. Cambridge University Press, Cambridge.)



fusion the chloroplast of the male gamete is resorbed, and the zygote contracts.

The process of conjugation is subject to a number of variations. In *Spirogyra*, for example, adjacent cells of the same filament may sometimes conjugate. In *Zygnema* and *Mougeotia* the zygote is often formed in the conjugation tube (Fig. 3.33b). Sexual differentiation of a morphological nature is seen in *Sirogonium*. Here the male gametangium, regularly associated with a sterile cell, is notably smaller than the female. In all instances the zygote forms a spore (zygospore) with a thick wall containing a sporopollenin-like material. After a period of dormancy the spore germinates and gives rise to a single filament (Fig. 3.33d). In those species investigated, meiosis has been shown to occur before germination, but three nuclei degenerate. The survival of only one meiotic product prevents a direct analysis of Mendelian segregation.

There are evident affinities in relation to sexual reproduction between the Mesotaeniales, Desmidiiales and Zygnematales. These three orders have often been grouped together as the Conjugales.

The Coleochaetales

The Coleochaetales are a small order of which *Coleochaete* is fully representative (Fig. 3.34). The genus contains many freshwater epiphytes. The habit is basically heterotrichous, but the prostrate element is usually dominant. An exception is *C. pulvinata* in which the erect branches form a conspicuous hemispherical cushion. Sheathed bristles are a characteristic feature of the thallus of *Coleochaete*.

The prostrate portion of some species of *Coleochaete* (e.g., *C. scutata*, often epiphytic on leaves of the aquatic angiosperm *Najas*) becomes parenchymatous. A phragmoplast has been observed at cell division and the dividing walls are penetrated by plasmodesmata.

REPRODUCTION

Coleochaete is also outstanding in certain features of its oogamous sexual reproduction. The cells which differentiate into oogonia terminate short branches, although they may ultimately appear lateral because of continued growth from the penultimate vegetative cell. The oogonium develops a long neck, termed a trichogyne (Fig. 3.34b), which opens at the tip when the egg is ready for fertilization. The antheridia arise in the filaments, often just above the oogonium, and each produces a single colorless spermatozoid. On liberation they are attracted, presumably chemotactically, to the receptive spot at the tip of the trichogyne, and fertilization follows.

As a consequence of fertilization, but in a manner still unknown, the vegetative cells adjacent to the oogonium are stimulated into growth and envelop the zygote in a continuous parenchymatous sheath. Symplastic connections between the zygote and the covering cells are lacking, but the common wall may develop irregular projec-

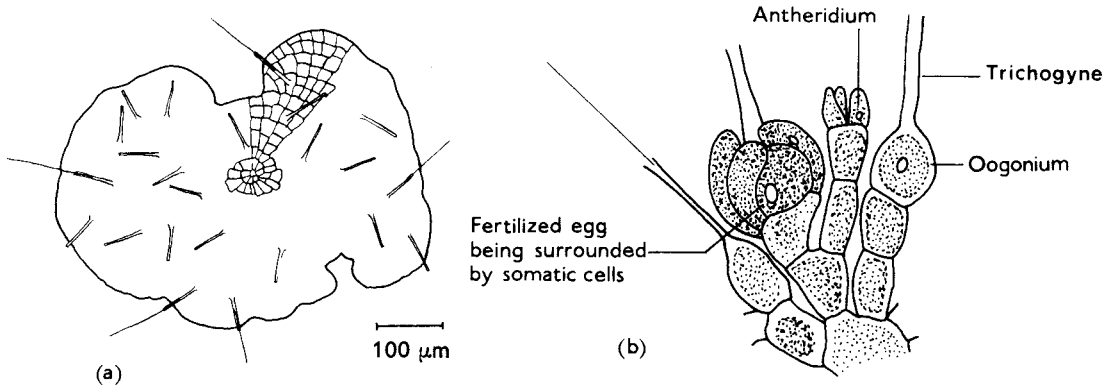

Figure 3.34 *Coleochaete*. (a) *C. scutata*, surface view. (b) *C. pulvinata*, sexual reproductive structures. ((a) after West and Fritsch. 1927. *A Treatise on the British Freshwater Algae*. Cambridge University Press, Cambridge; (b) after Pringsheim, from Fritsch. 1935. *The Structure and Reproduction of the Algae*, vol. 1. Cambridge University Press, Cambridge.)

tions suggestive of the thickened and labyrinthine boundary found between the gametophyte and embryo sporophyte in archegoniate plants (p. 103). The sheath eventually dies, but its cells contribute to the wall which forms around the resting zygote. This wall is acetolysis-resistant and may contain sporopollenin, although polymerized fatty acids are also a possibility. In the prostrate species the zygotes are retained in the parent thallus.

After a resting period the zygote germinates and the nucleus undergoes meiosis. This is followed by several mitoses giving rise to a plate of 16 or 32 wedge-shaped cells. The original wall of the zygote eventually bursts and each cell liberates a biflagellate swimmer. Asexual reproduction of the parent thallus also takes place by the liberation of single zoospores.

The motile cells of *Coleochaete* show a remarkable development, referred to as a multilayered structure (MLS), beneath the basal bodies of the two flagella. This consists of a flat ribbon of about 100 microtubules overlying an array of narrow plates, each about 50 nm deep and with a central discontinuity (Fig. 3.35). The alignment of the microtubules is transverse to that of the plates. One end of the ribbon continues without curvature into the body of the cell (Fig. 3.35, right). Although minute, the MLS is very distinctive. A

very similar structure is encountered again in the motile male gametes of archegoniate plants (pp. 104, 153).

A plant with a thallus resembling that of *Coleochaete* was *Parka* (Fig. 3.36) from the Upper Silurian and Lower Devonian. The thallus consisted of a pseudoparenchymatous disk formed by two layers of filaments radiating from a central holdfast. Sporangia, lying between the two layers, yielded great numbers of spores. These had robust laminate walls, but chemical analysis gives no firm indication of the presence of sporopollenin. There was no obvious germinal aperture. The occasion of meiosis is naturally unknown, but the very numerous spores suggest that it may have been delayed until after the zygotic nucleus had undergone a number of mitoses. *Parka* may therefore give an insight into the origin of a multicellular sporophyte generation within the charophycean algae, and may represent a form transitional between the algal and bryophytic grades of reproduction. However, despite its tempting characteristics, *Parka* appears after the earliest occurrences of bryophytic and vascular plants, and cannot be considered a potential ancestral form (cf. *Protosalvinia*, p. 93).

The Charales

The Charales reach the highest level of differentiation encountered in the Chlorophyta. Nevertheless they remain basically similar to other Chlorophyta in pigmentation, metabolism and the limited nature of their anatomy. There are only six living genera, the remainder being fossil. The living *Chara* and *Nitella* are common in base-rich waters, particularly those which are not too

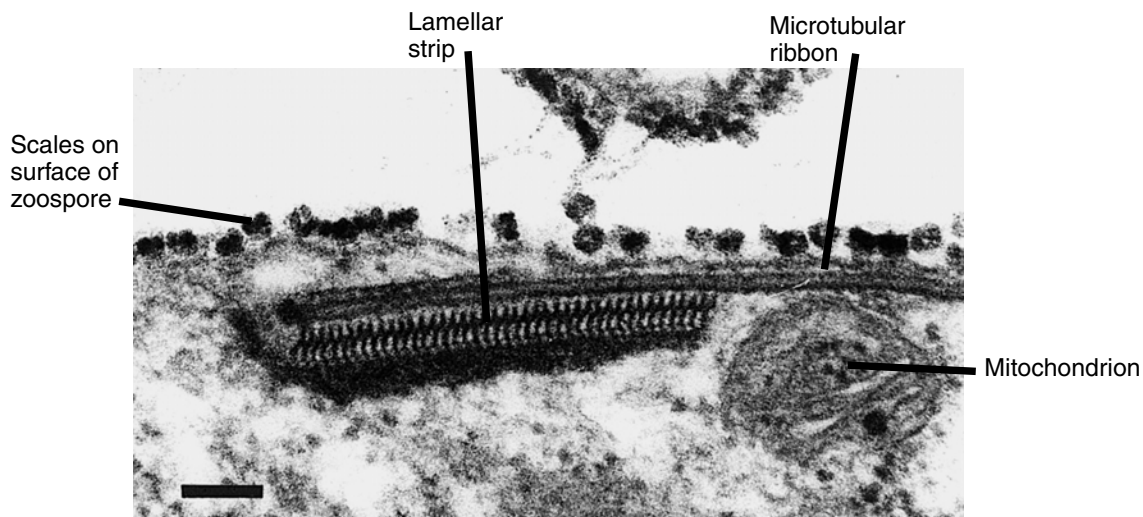

Figure 3.35 *Coleochaete*, zoospore. Section of the multilayered structure (MLS) at the anterior of the cell. The section is parallel to the alignment of the microtubules of the microtubular ribbon (spline). The plates of the lamellar strip are perpendicular to the microtubules and are consequently cut transversely. The anterior edge of the MLS lies beneath the basal bodies of the flagella (not visible in this section). The microtubular ribbon continues to the posterior of the cell and is presumably an important structural element. Scale bar 0.1 μm . (Electron micrograph by H. J. Sluiman. 1983. Reproduced from *Protoplasma* 115, by permission of Springer-Verlag, Vienna.)

fast-moving and with a muddy substratum to provide anchorage. A few Charales are found in brackish waters (e.g., *Lamprothamnium*). Many species develop an exoskeleton of calcium carbonate (hence the name “stoneworts”). This is clearly an ancient feature since charalean exoskeletons, which are readily preserved as fossils, can be traced back as far as the Devonian.

The thallus of the Charales always possesses a clear main axis, growing from a dome-shaped apical cell (Fig. 3.37). Segments are cut off at regular intervals and in a single column from the flat base of this cell, and each segment immediately divides again by a transverse wall. The upper cell of this division becomes a nodal initial, and the lower, which does not divide again, an internode cell. The nodal initials remain meristematic and give rise to whorls of branches, mostly of limited growth. The mature plant thus has a morphology reminiscent of *Draparnaldiopsis*. The

internode cells often achieve remarkable lengths (up to 10 cm (4 in.) or more in *Nitella*), and the cytoplasm commonly shows vigorous streaming, rates of up to $100 \mu\text{m s}^{-1}$ being common. The streaming persists in protoplasts extracted enzymically from internodal cells, although these adopt a spherical form. The chloroplasts, which are discoid and lack pyrenoids, are however little affected by the streaming since they lie in an outer, less active layer (ectoplasm). The streaming is associated with actin microfilaments, about $50 \mu\text{m}$ in length, accompanied by myosin, being present in a single cell. The nucleus often fragments in mature cells. Symplastic continuity is preserved in *Chara* and *Nitella* by the presence of plasmodesmata. These have a structure quite similar to that of the plasmodesmata of land plants.

The large size of the internode cells of *Nitella* makes them ideal for studying permeability. It is even possible to cut off the ends and wash out the contents, leaving the plasmalemma intact. The biophysical properties of this membrane can then be investigated without interference from the cytoplasm.

In *Nitella* the internodes consist only of the single internode cell, but in *Chara* this becomes surrounded by a cortex formed of rows of cells growing down from the lower cells of the node.

Unlike most benthic algae the Charales are usually anchored to a soft substrate. Attachment is by colorless branched rhizoids which issue from the lower subterranean nodes. The rhizoids are

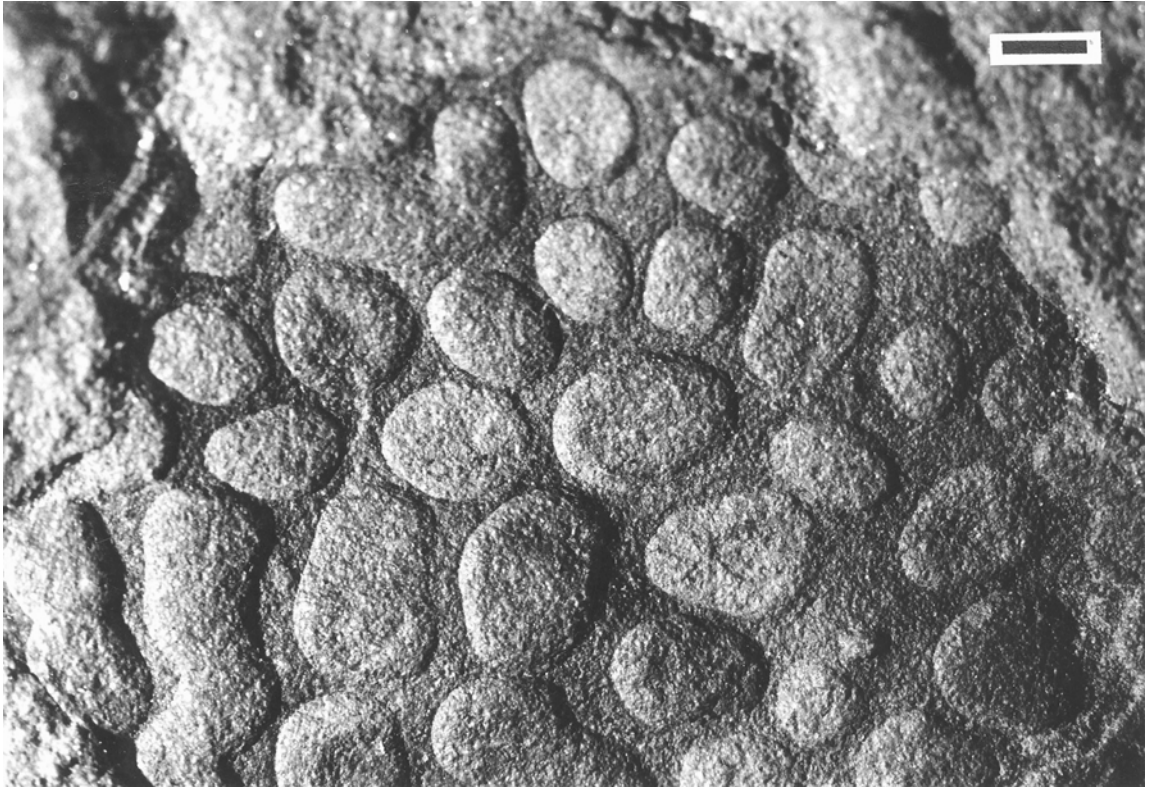

Figure 3.36 *Parka decipiens*. An impression fossil from the Old Red Sandstone, Forfar, Scotland. The prominences on the surface of the thallus correspond to the position of the sporangia within. Scale bar 1 mm.

negatively gravitropic and contain aggregated crystals of barium sulfate. These may act as statoliths, and by deflecting the flow of Golgi vesicles containing wall materials to one side of the cell cause differential growth, and hence curvature. Little information is available about the extent to which the rhizoids take up nutrients from the substratum.

REPRODUCTION

Vegetative propagation, the only method of asexual reproduction, is by the formation of tuberous outgrowths on subterranean nodes or rhizoids. These become filled with starch and can withstand unfavorable conditions. The nodal outgrowths often have a stellate symmetry (“starch stars”).

Sexual reproduction is oogamous, and highly specialized. The male and female reproductive

structures, which consist of antheridia and oogonia (sometimes termed oosporangia) surrounded by envelopes of sterile tissue, are sufficiently large to be seen with the naked eye. In both monoecious and dioecious species, the antheridia develop just below the insertions of the lateral appendages (Fig. 3.38). A complicated sequence of divisions leads to the mature antheridium.

The eight peripheral cells of the original primordium form the wall of the antheridium. Attached to the inner surface of the wall are the manubria. These rod-shaped receptacles give rise to numerous threads of spermatogenous cells (Fig. 3.39) which fill the cavity of the antheridium. Each spermatogenous cell produces a single biflagellate spermatozoid.

In *Chara*, the spermatozoid has an osmiophilic “headpiece” at the anterior end (Fig. 3.40), in which the basal bodies of the flagella, one slightly ahead of the other, are embedded. The flagella are directed obliquely backward and extend about the length of the spermatozoid. Before release, the mature spermatozoid is coiled in an anticlockwise sense (when viewed from the anterior end)

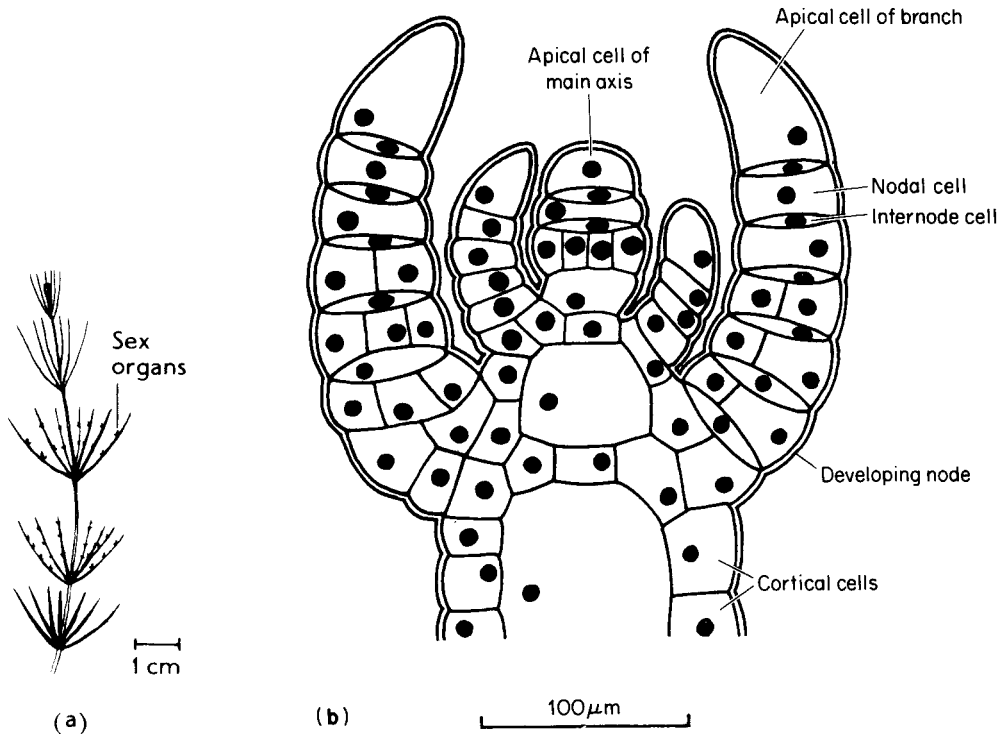

Figure 3.37 *Chara*. (a) Habit. (b) Detail of apex of main axis. ((b) after Esser. 1976. *Kryptogamen*. Springer-Verlag, Berlin.)

into a helix of $2\frac{1}{2}$ gyres, the total length of the gamete being about $55\mu\text{m}$. Behind the headpiece lies a row of about 30 mitochondria, and above them a microtubular ribbon, 14–16 microtubules wide at the anterior end, but expanding to a maximum of 38 microtubules toward the posterior. This ribbon runs into the tail of the gamete. The nucleus takes the form of a narrow cylinder, occupying about $1\frac{1}{2}$ gyres and reaching $17\mu\text{m}$ in length. The chromatin is longitudinally striated. The terminal half-gyre of the helix is occupied by six starch-containing plastids. There is no MLS associated with the motile apparatus of the kind seen in the zoospore of *Coleochaete* (Fig. 3.35), but one has been reported in the spermatozoid of the related *Nitella*. In general the spermatozoids, with their long narrow nuclei, resemble those of the simpler archegoniate plants (Chapter 5). The walls of the mature antheridia of the Charales are often rendered bright red by accumulating carotenoids.

Oogonia, as they approach maturity, become surrounded by a spiral of elongated vegetative

cells, at the tip of which short columns of rounded cells come together as a corona (Fig. 3.37). Within this sheath lies the egg cell (or oosphere) mother cell. This undergoes a single division and cuts off a small sterile cell below, leaving the egg cell (oosphere) above. This accumulates food reserves, increasing its major diameter from about 40 to $600\mu\text{m}$ and its volume by a factor of about 3000. The cytoplasm becomes dense and difficult to fix satisfactorily for ultrastructural examination. Spermatozoids penetrate slits which appear in the coronal region, and fertilization occurs at a small clear area near the apex of the egg, the so-called "receptive spot". After fertilization a cellulose membrane is secreted by the zygote. This, together with the wall of the oogonium and the inner walls of the spiral cells, which become thickened and indurated and in which sporopollenin has been reported, enclose the zygote in an almost impervious jacket, often reinforced externally with calcium carbonate.

Germination, which occurs after a resting period, is promoted by red light, indicating that it is controlled by a phytochrome system. Meiosis almost certainly occurs at germination, but it has

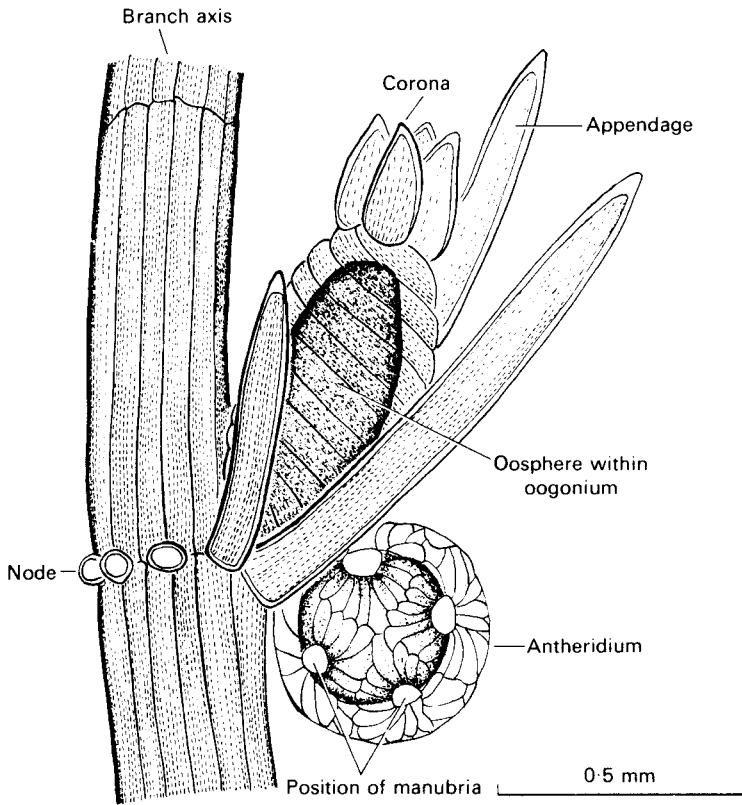

Figure 3.38 *Chara* sp. Male and female reproductive organs.

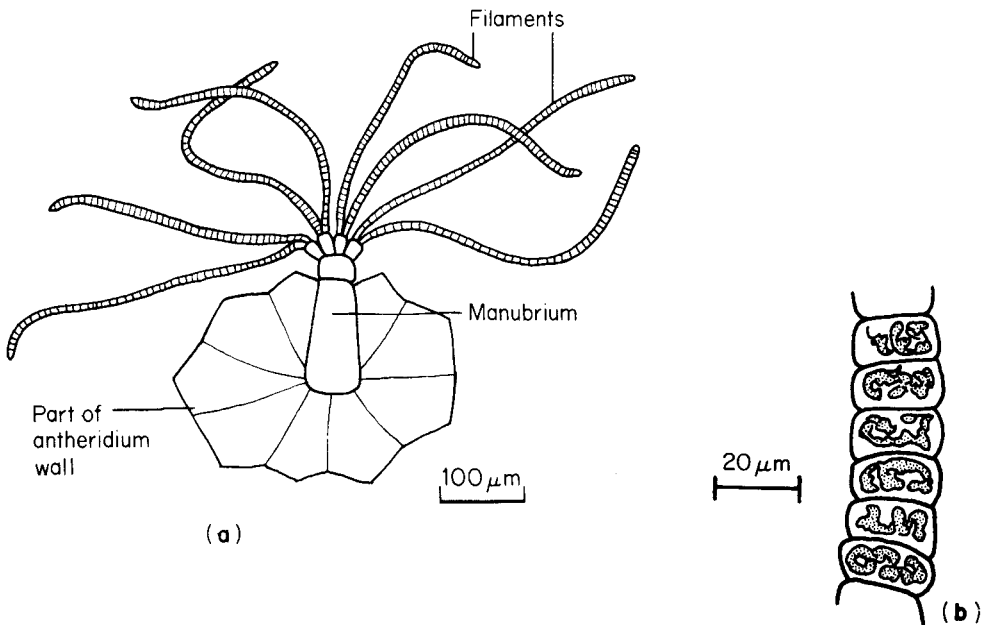
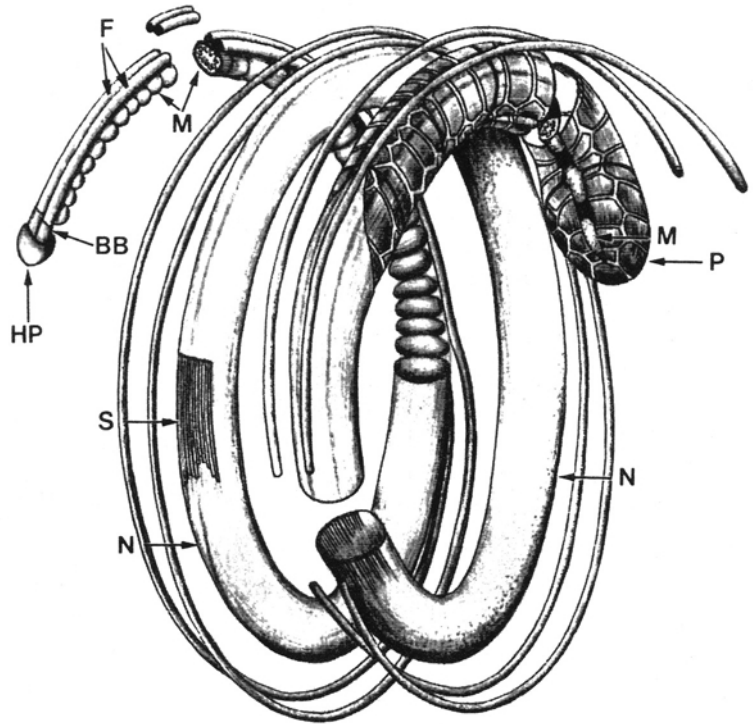

Figure 3.39 *Chara*. (a) Antheridial filaments. (b) Differentiating spermatozooids in cells of filament.

Figure 3.40 *Chara*. Mature spermatozoid, as at liberation. A headpiece (HP) lies at the anterior end of the gamete. Behind this are the two basal bodies (BB). A row of mitochondria (M) begins below the flagella (F) before their emergence and continues into the posterior of the gamete. A ribbon of microtubules, about 14 microtubules wide at its initiation, also begins near the headpiece and runs posteriorly, increasing in width as it enters the mid-portion of the gamete. The nucleus (N), accompanied on its outer side by the microtubular ribbon (S), occupies about 1½ of the posterior gyres. The last half-gyre is occupied by about six plastids (P) with prominent starch. The gamete measures about 55 μm from head to tail, and is sinistrally coiled into 2½ gyres. (From Duncan, Renzaglia and Garbary, 1997. *Plant Systematics and Evolution* 204.)



been little investigated because of cytological difficulties. Apparently only one of the tetrad of nuclei so produced remains intact; the remainder degenerate. Division of the intact nucleus leads to the production of two cells, which, as the membranes of the zygote break open at the apex, yield from the one a rhizoid and from the other an erect green filament. This filament is the *protonema*, a stage of development peculiar, in the Chlorophyta, to the Charales. Cell divisions occur in the protonema, and it differentiates into nodes and internodes. The first node gives rise to rhizoids and additional protonema, and the second to a whorl of laterals, one of them developing into a normal main axis and the others into yet more protonema. The mature plants thus arise at lateral branches of protonemal filaments.

At least one species of *Chara* has been shown to be parthenogenetic, but aberrations of the life cycle have been little investigated.

RELATIONSHIPS

The relationships of the Charales are largely speculative. The fossils show that they are an

extremely ancient type of algal organization, even fossilized reproductive organs and, more commonly, zygotes (*Gyrogonites*) being recognizable in rocks as old as the Devonian. A charophyte (*Palaeonitella*) parasitized by a fungus has been observed in the Rhynie Chert (p. 27).

The small discoid chloroplasts of the Charales are more like those of the higher plants than those of Chlorophyta generally, but there is no evidence that terrestrial plants came directly from *Chara*-like ancestors. The Charales share with the desmids and *Spirogyra* the presence of barium sulfate crystals in the cells, and whorled branching and an archegonium-like oogonium are represented in *Draparnaldia* and *Coleochaete* respectively. Although there may be distant relationships, the Charales are best regarded as a highly specialized, and in certain ecological situations highly successful, order of aquatic plants, long separated from the main trends of algal evolution. They seem to have reached their maximum representation in Jurassic times and their diversity is probably less now than formerly.

Pleurostrophyceae

The small class Pleurostrophyceae contains flagellate, coccoid and filamentous forms, mostly freshwater and occasionally terrestrial. The basal bodies of the flagella of the motile stages show characteristically a counterclockwise orientation (Fig. 2.2B), in contrast to the clockwise orientation found in the Chlorophyceae. The most notable genus currently included here is *Trentepohlia* (sometimes placed in a separate class), worldwide in distribution and common in warm moist situations. The heterotrichous thallus grows on rocks, bark and shaded leaves, as well as on soil and humus, and is often conspicuous for its orange, rather than green, appearance. The cell walls are thick and often layered, and this feature probably accounts for the ability of the alga to resist desiccation. When growth is inhibited, as in conditions of drought, there is a marked increase in the pigmentation of the cells, and concurrently an accumulation of fat, in which the red pigment (hematochrome) is dissolved. Some species of *Trentepohlia* are components of lichens.

Reproduction

Asexual reproduction is by biflagellate zoospores, and takes place only in damp conditions. Sporangia may be sessile or stalked. The stalked sporangia are often distributed by wind, the liberation of the zoospores taking place in damp conditions. Purely vegetative propagation also occurs by dispersal of fragments of the prostrate system.

Isogamous sexual reproduction has been reported in some species. A multilayered structure has been detected in the motile cells, but it is not identical with that occurring in the Charophyceae. There is some evidence for an isomorphic life cycle, the sporophyte producing quadriflagellate zoospores meiotically, so re-establishing the gametophytic phase.

Trebouxia is a widespread member of the Pleurostrophyceae. It is unicellular, the cells sometimes forming rectangular packets (*sarcinoid* colonies). The cells contain a prominent stellate chloroplast with a central pyrenoid. Reproduction is by biflagellate zoospores or by autospores. *Trebouxia* is a component of many lichens.

Evolution within the Chlorophyta

It is reasonable to regard the unicellular forms as relicts of the most primitive green algae, and this is supported by comparisons of nucleotide sequences in ribosomal RNA. Diversification can be envisaged as being accompanied by a progression toward colonial, coenobial and filamentous organization, this taking place in a number of parallel lines resulting in the major classes recognized today. In Table 3.1 the classes are placed according to the level of organization reached by their thalli. Ultrastructural and molecular studies reveal, however, that evolution has not followed simple linear paths as Table 3.1 might suggest. The positional relationships of the basal bodies (Fig. 2.2), for example, in flagellate unicells and motile stages of multicellular forms show phylogenetic heterogeneity. The 11 o'clock–5 o'clock and 1 o'clock–7 o'clock arrangements, in particular, appear to have emerged several times independently in different alliances.

Eukaryotic forms presumably arose from the prokaryotic, as discussed in relation to the Rhodophyta (p. 36). Although *Prochloron* immediately excites interest as a possible ancestor of the “a + b” plastid, there are substantial differences in the carotenoids. A direct relationship is now considered unlikely (p. 39).

There are, however, compelling reasons for regarding the Charophyceae as being close to the algae from which the land plants arose. This is discussed further in Chapter 5.

EUGLENOPHYTA

Habitat Freshwater, a few marine.

Pigments Chlorophylls *a*, *b*; β -carotene; diadinoxanthin, other xanthophylls less prominent.

Food reserve Paramylum.

Cell wall components No cell wall, but a pellicle containing a helically arranged structural protein present in many.

Reproduction Asexual, sexual doubtful, but if present isogamous.

Growth form Predominantly unicellular, flagellate.

Flagella Two, but only one (rarely two) emerging from the gullet, Flimmer, anterior.

Table 3.1 | The living green algae arranged according to the level of complexity attained in their respective classes, and their relative position in the evolution of “*a + b*” plants. The relationships between the classes appear too remote to indicate affinities. A class which has reached a thalloid level of organization may nevertheless retain flagellate forms (e.g., *Chlamydomonas* within the Chlorophyceae). The lateral displacements represent an estimate of the distance of the classes named from the line of evolution leading to the land plants.

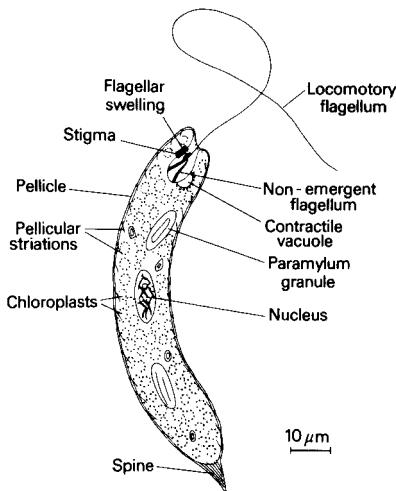
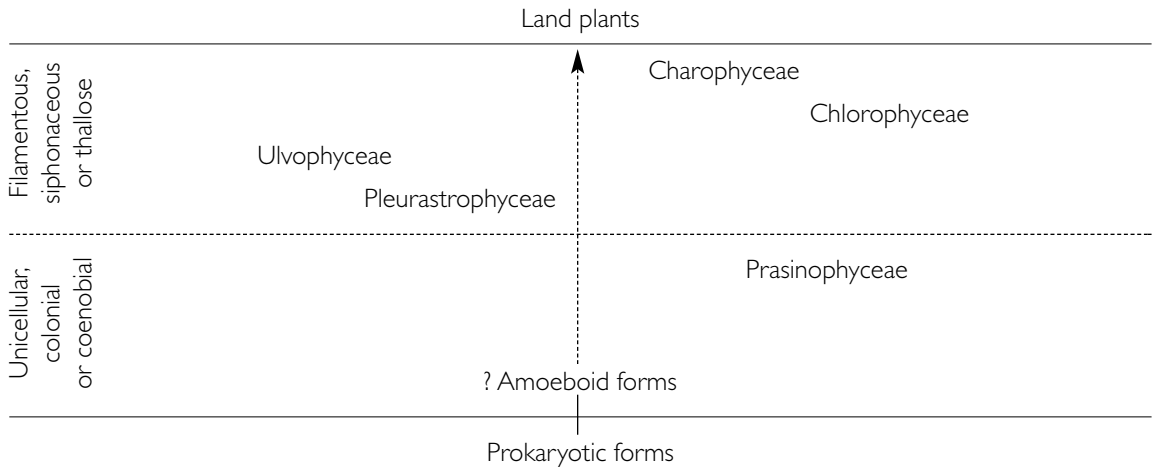

Figure 3.41 *Euglena spirogyra*. Reconstruction of cell based on photo- and electron micrographs. (From Leedale, Meeuse and Pringsheim. 1965. *Archiv für Mikrobiologie* 50.)

The Euglenophyta have been assigned to both the plant and animal kingdoms, since the division contains both green autotrophic and colorless heterotrophic forms. Many of the autotrophic Euglenophyta are also able to thrive in the dark if supplied with suitable metabolites, so they can be regarded as facultative heterotrophs. Races free of chloroplasts can be raised by growing cultures at

35 °C (95 °F), when cell division proceeds faster than chloroplast fission so that some cells eventually lack them altogether. Similar colorless races can also be produced by low concentrations of streptomycin, a drug which inhibits chloroplast replication. It seems probable that naturally heterotrophic species have evolved by spontaneous loss of plastids from autotrophic forms.

Although heterotrophic nutrition, a feature of animals, is common in the Euglenophyta, the evidence points to the ability to ingest organic food materials being a secondary feature. Heterotrophic nutrition, both facultative and obligate, is in fact known in many other algae. Examples are provided by the Cyanophyta, and by *Polytoma* (Volvocales) and *Prototheca* (Chlorococcales) in the Chlorophyta. The Euglenophyta are nevertheless outstanding in the extent to which they have developed this facility. Similarly a cell wall, absent in the Euglenophyta and animal cells generally, is by no means always present in other flagellate unicellular algae. It is lacking for example in *Dunaliella* (p. 42), otherwise similar to *Chlamydomonas*, and in *Micromonas* (p. 11). Flagellate zoospores and gametes are also commonly naked.

The mode of nutrition and presence or absence of a cell wall thus appear to be relatively

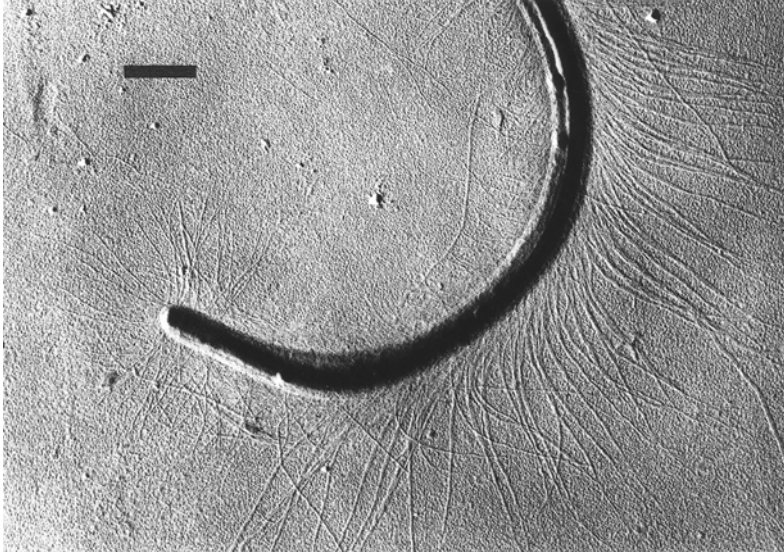

Figure 3.42 The tip of the flagellum of *Euglena gracilis* showing the “Flimmer” hairs. Shadowed preparation. Scale bar 1 μm . (Electron micrograph by G. F. Leedale. © Biophoto Associates.)

lakoids. A pyrenoid is present, but the storage product paramylum (a β -1,3-linked glucan) is formed outside the chloroplast. The paramylum granules are highly crystalline and bounded by a single membrane. The nucleus lies in or near the posterior half of the cell and chromosomes remain contracted throughout inter-

phase, recalling the situation in the dinoflagellates (p. 96). At the anterior end of the cell is a small invagination, the gullet, which in heterotrophic forms may serve for the ingestion of food. A system of vacuoles discharges at intervals into the gullet and provides for osmoregulation. There are two flagella, only one of which, normally Flimmer (Fig. 3.42), emerges through the mouth of the gullet. The base of this flagellum bears a thickening, believed to be a photoreceptor, close to the stigma in the adjacent cytoplasm.

Euglena, representative of the **Euglenales**, is normally autotrophic, the cells containing several discoid or band-like chloroplasts (Fig. 3.41). Each has a compound envelope of three membranes, the outer of which is continuous with the endoplasmic reticulum. Some species abound in water rich in organic material, such as seepage from dunghills and farmyards, while others occur on damp mud by rivers, salt marshes and similar places.

The cell is retained in a characteristic spindle-like shape by a rigid outer layer of cytoplasm termed a pellicle. Electron microscopy has shown that the pellicle contains a band-like proteinaceous component wound in several helices around the cell. This structural protein lies against the plasmalemma and is associated with microtubules. In those species in which the pellicle is flexible a flowing peristaltic movement is commonly observed, particularly if flagellar movement is constrained or the flagella are shed. The causes of this “metabolic” movement are obscure. The chloroplasts lie toward the periphery of the less viscous cytoplasm, and the lamellae characteristically consist of three appressed thy-

lakes. Possibly belonging to the heterotrophic Euglenophyta is *Scytomonas*, a common intestinal parasite. Its cytology closely resembles that of *Euglena*, and paramylum and fat occur as food reserves.

Reproduction

Reproduction

Binary fission is the common method of reproduction of the Euglenophyta. By the end of nuclear division the locomotor apparatus is replicated and cleavage of the whole cell proceeds from the anterior to the posterior end. Nuclear division resembling meiosis has been reported, but well-established instances of sexual reproduction in the Euglenophyta are lacking.

Although predominantly flagellate, a few Euglenophyta are encapsulated and form dendroid colonies. These can be regarded as the result of developmental trends from the flagellate state which parallel those in other algal groups, but

which have reached only a rudimentary level of morphological complexity. The **Eutreptiales** differ from the Euglenales in being biflagellate.

Relationships

The relationships of the Euglenophyta with other algae are obscure. In the presence of chlorophylls *a* and *b* they resemble the Chlorophyta, but the carotenoid composition of the plastids is significantly different. The ability of *Euglena* to grow heterotrophically in the absence of plastids is unique amongst the algae. This would be in line with the view that *Euglena* originated from a flag-

ellated heterotroph which had ingested plastids from another source. The third outer membrane of the chloroplast envelope would then represent the bounding membrane of the food vacuole of the original protozoan. Assuming the photosynthetic activity of the plastid remained unimpaired, the composite organism would be effectively phototrophic. Any relationship with the Chlorophyta would be correspondingly remote and indirect. This would be in agreement with the observed biochemical and metabolic differences between the Chlorophyta and the Euglenophyta.

The subkingdom Algae: Part 3

Algae containing chlorophylls *a* and *c*

Although chlorophyll *a* is always present in the algae to be considered in this chapter, the amount of chlorophyll *c* is sometimes small. Chlorophyll *b* is always absent (but see Dinophyta, p. 95).

The “*a + c*” algae show a number of organizational trends resembling those seen in the Chlorophyta. There are also features not represented in living Chlorophyta, but possibly present at some stage in their evolutionary history. The chlorophyll *c*-containing algae are sometimes referred to collectively as the “chromophyte algae”. The first four divisions considered here constitute the “heterokont algae” (Table. 2.1), and have a number of basic features in common, relating principally to the flagella and chloroplasts. Besides (where two are present) the inequality and difference in ornamentation of the flagella, the chloroplast is typically surrounded (in addition to its normal envelope) by a fold of endoplasmic reticulum. This “chloroplast endoplasmic reticulum” is part of the general endoplasmic system, connected with the outer membrane of the nuclear envelope. It is not, however, confined to the heterokonts, but is found also in the Haptophyta (p. 93) and Cryptophyta (p. 96), not regarded as closely allied to the heterokont algae.

CHRYSOPHYTA

Habitat Aquatic (mainly freshwater), often common in plankton.

Pigments Chlorophylls *a*, *c*; β -carotene; fucoxanthin conspicuous, but other xanthophylls also present.

Food reserves Fat, chrysolaminarin (leucosin).

Cell wall components Cellulose, hemicelluloses, often with siliceous scales.

Reproduction Asexual, occasionally sexual.

Growth forms Flagellate, coccoid, colonial, rarely filamentous; amoeboid stages in some forms.

Flagella Two unequal (one Flimmer, usually the longer), or one (Flimmer), anterior; in some uniflagellate forms a second present as a stump detectable only with the electron microscope.

Although the Chrysophyta are strikingly different in color (the cells usually contain two golden-brown chloroplasts (chromatophores)), the members of this division show many growth forms resembling those found in the Chlorophyta. The highest levels of organization attained however are only the simple filament and small discoid parenchymatous thalli, suggesting that evolution, although parallel, has also been very much slower than in the green algae.

The Chrysophyta are of considerable interest from the physiological and biochemical points of view. The characteristic food reserve, chrysolaminarin, contained in solution in special vacuoles, is a β -1,3 glucan. The frequent occurrence of silica is also notable. Ecologically they are often important components of plankton. The marine *Aureococcus* is well known for its production of recurrent “brown tides” along the east coast of

Figure 4.1 (a) *Ochromonas*. (b) *Mallomonas*. (After Scagel, Bandoni, Rouse, Schofield, Stein and Taylor. 1966. *An Evolutionary Survey of the Plant Kingdom*. Wadsworth, Belmont.)

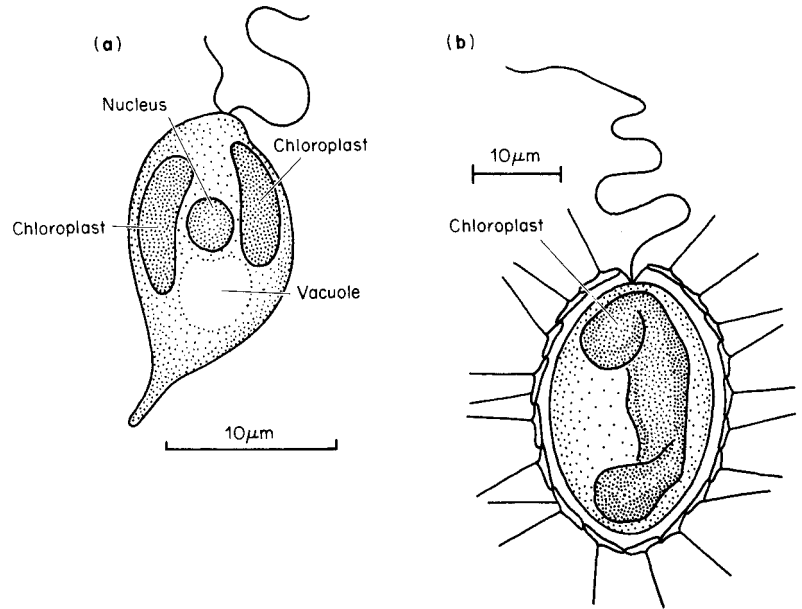

North America, sometimes reducing the light intensity on the sea bed sufficiently to cause the death of marine angiosperms such as *Zostera*.

Flagellate forms

The flagellate habit is represented by a number of species, often referred to as the chrysomonads, some of which are able to alter their shapes and method of locomotion.

Ochromonas, for example, is commonly pear-shaped, with two unequal flagella (one up to six times the length of the other) emerging from a depression at the anterior end (Fig. 4.1a). Sometimes however it may lose this shape and produce narrow outgrowths (rhizopodia), the flagella being lost. This amoeboid phase may also pass over temporarily into a thick-walled cyst. *Ochromonas* is also nutritionally versatile and at least one species is capable of feeding on a unicellular blue-green alga.

In the common planktonic *Mallomonas* (Fig. 4.1b) the pectinaceous wall is covered with imbricating siliceous scales, some of which bear delicate hinged needles, often as long as the cell itself, possibly assisting flotation. The curious Silicoflagellineae (Dictyochales) are also placed with the Chrysophyta. These are uniflagellate planktonic organisms furnished with an intracellular siliceous skeleton. The cell has little or no wall, and produces rhizopodia. Although the silicoflagellates are now rare, their skeletons are well known as fossils from the Tertiary onward, indicating former abundance.

The longer flagellum in *Ochromonas* is furnished with mastigonemes which themselves bear minute filaments. Electron microscopy has shown that, after beginning their assembly in the perinuclear space, the mastigonemes are trans-

ferred to Golgi vesicles, where the filaments are added. They then pass, still in vesicles, to the site of emergence of the flagellum, and appear in two rows on the flagellar surface. The cells of some unicellular chrysophytes are invested with elaborate scales. Those of *Sphaleromantis tetragona*, a species of freshwater ponds, for example, resemble miniature flower pots attached at their bases. These are also assembled in Golgi vesicles and passed to the exterior.

Palmelloid and coccoid forms

A number of these are commonly encountered in the field. *Synura* forms a free-floating colony in the plankton of drinking-water reservoirs. The individual cells are similar to *Mallomonas*, but are held together in a gelatinous mucilage. *Hydrurus*, which forms brownish layers on rocks in alpine streams, is similar but the mucilaginous matrix branches irregularly. In *Dinobryon* (Fig. 4.2a), frequent in both fresh water and the sea, the cells are elongate, and each is enclosed in a cellulose sheath. The sheaths are commonly connected head to tail.

Filamentous and thalloid forms

The only filamentous form of note is *Phaeothamnion* (Fig. 4.2b), found on rocks in rapidly flowing streams. The club-shaped cells form

branching filaments which readily disarticulate when disturbed.

The thalloid forms are few. *Chrysothallus* is found as small parenchymatous disks, epiphytic upon the cartilage-like stalks of the colonial pennate diatom *Gomphonema* (p. 82) in Lake Baikal.

Reproduction

Reproduction of the Chrysophyta is predominantly asexual, longitudinal fission being characteristic of the unicellular flagellates. In *Dinobryon* one product of the division moves out of the sheath and forms a new sheath attached to the rim of the old, accounting for the characteristic form of the colony. Copulation of flagellated cells has been observed in some instances. A life cycle has been demonstrated in *Synura*. The colonies may apparently be male or female. Gametes from the male swim to the female and fuse with female gametes. The gametes are indistinguishable from vegetative cells, and copulation is isogamous. The zygote forms a cyst surrounded by a siliceous wall. Meiosis probably occurs on germination. In general, however, little is known of the life histories of the Chrysophyceae.

XANTHOPHYTA

Habitat Aquatic (mostly freshwater), damp soil.

Pigments Chlorophylls *a*, *c*, (*e*); β -carotene; heteroxanthin, diadinoxanthin, diatoxanthin, vaucheriaxanthin.

Food reserves Fats, chrysolaminarin.

Cell wall components Cellulose, hemicellulose.

Reproduction Asexual and sexual, in some forms oogamous.

Growth forms Flagellate, coccoid, colonial, filamentous, siphonaceous.

Flagella Typically two, strikingly unequal, the larger usually flimmer.

In this division the amount of chlorophyll *c* is again often small. Chlorophyll *e*, reported to occur in some members, is now regarded as possibly a breakdown product of chlorophylls *a* or *c*. The absence of fucoxanthin from the plastids causes the Xanthophyta to be yellow-green in appearance compared with the Chrysophyta. Despite the relatively few representatives, the division again

shows a series of growth forms paralleling those of the Chlorophyta. In the Xanthophyta the organization attained exceeds that in the Chrysophyta. *Vaucheria*, for example, has a well-established siphonaceous habit and complex oogamy.

The inequality of the flagella, and their insertion to one side of the apex, are typically heterokont. The cell walls in many forms show a tendency to fall into two halves. The chloroplasts are green, but, in contrast to those of the Chlorophyta, they will often turn blue in dilute hydrochloric acid.

Flagellate and coccoid forms

Representative of the simplest flagellate forms is *Chloromeson* from the Baltic, resembling in organization the chrysophyte *Ochromonas*, and, of the coccoid, *Chlorobotrys* (now sometimes placed in a separate class, Eustigmatophyceae, on account of the apparent absence of chlorophyll *c*, and a peculiar kind of eyespot lying in the cytoplasm outside the chloroplast). *Chlorobotrys regularis* (Fig. 4.3a), common in bog and fen pools, has a spherical cell resembling *Chlorella*. Several cells are usually held together in mucilage forming a free-floating colony. *Myxochloris* (Fig. 4.4) is found not infrequently as a naked amoeboid plasmodium with conspicuous chloroplasts inside the hyaline water-storage cells of the bog moss *Sphagnum* (p. 118).

Filamentous forms

Of the filamentous forms *Tribonema* (Fig. 4.3b) is the most notable. The short unbranched threads are encountered in fresh water and on damp earth, usually in base-rich situations. It is often accompanied by iron bacteria with the consequence that the filaments become stained by rusty-brown deposits of ferric carbonate. The cell wall is clearly made up of two overlapping halves. Consequently the filament, when disrupted, breaks up into a number of pieces H-shaped in optical section, closely resembling the situation in the green alga *Microspora* (p. 52). It is the H-shaped piece, rather than the complete cell, which is the basic unit of the filament so far as the wall is concerned. At cell division, instead of the usual septum being formed, a new H-shape is produced at the center of the parent cell. Internally,

Figure 4.2 (a) *Dinobryon cylindricum*. (b) *Phaeothamnion*. ((a) after West and Fritsch. 1927. *A Treatise on the British Freshwater Algae*. Cambridge University Press, Cambridge.)

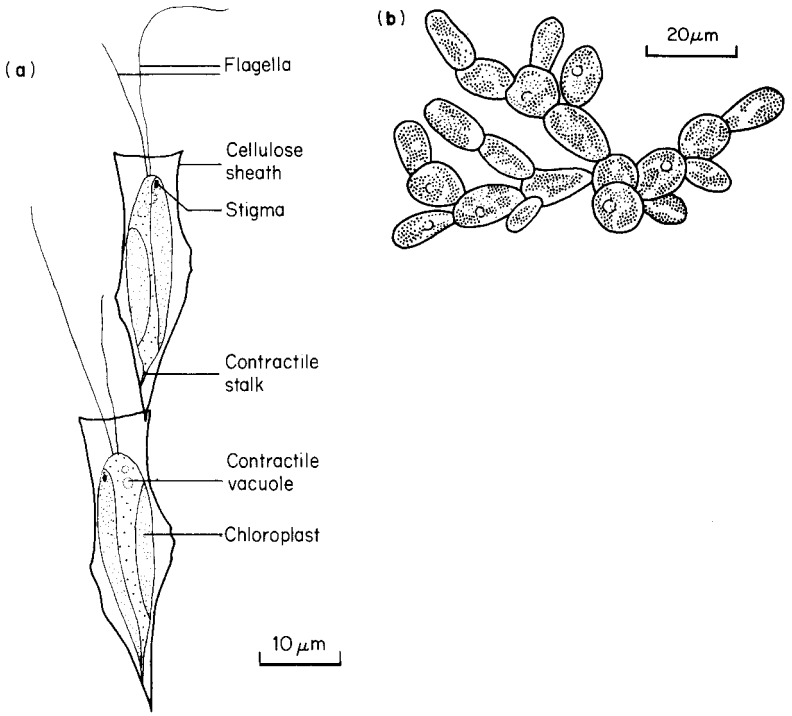
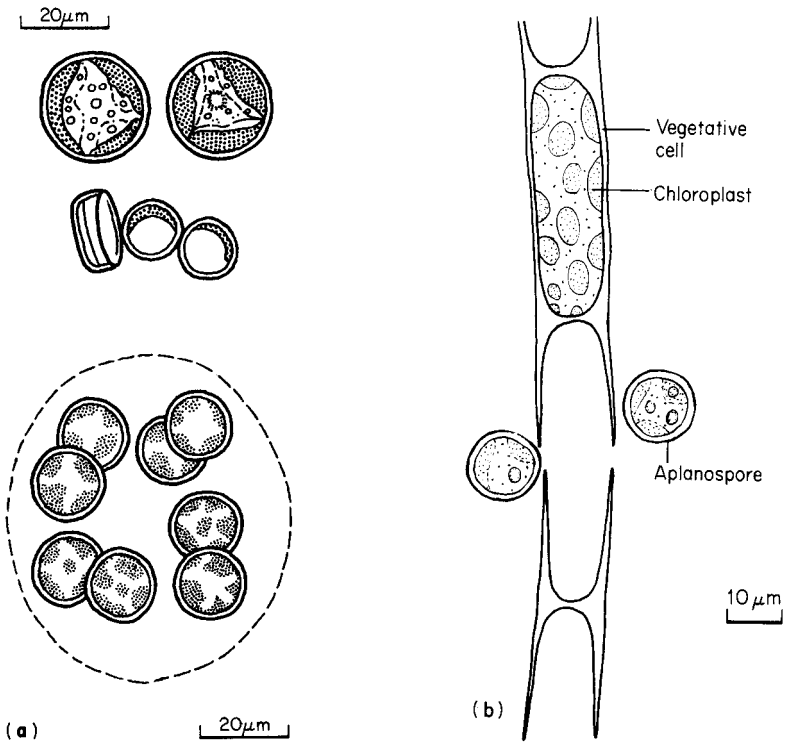

Figure 4.3 (a) *Chlorobotrys regularis*. Above, individual cells and germinating cyst; below, aggregate of cells held together in mucilage. (b) *Tribonema bombicinum*. (After West and Fritsch. 1927. *A Treatise on the British Freshwater Algae*. Cambridge University Press, Cambridge.)



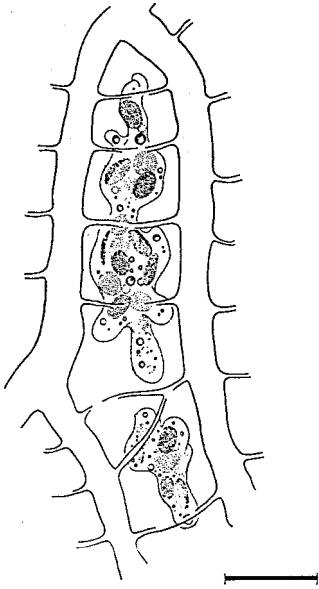

Figure 4.4 *Myxochloris*. Plasmodia in a water-storage cell in a leaf of *Sphagnum*. The plasmodia show slow amoeboid movement. Chloroplasts and lipid droplets are prominent. As the leaf ages the plasmodia form single-celled cysts which, on germination, yield typical heterokont biflagellate zoospores, providing for the spread of the alga in carpets of the moss. Scale bar 25 μm . (From Pascher. 1930. *Archiv für Protistenkunde* 72).

the cell organelles are disposed in much the same way as they are in *Microspora*, except that several lenticular plastids occupy the peripheral cytoplasm, instead of a single band-like plastid. Although the cells normally have a single nucleus there is evidence in some species of multinucleate cells, perhaps indicating a transition to a coenocytic condition.

Siphonaceous forms

The simplest of these is *Botrydium* (Fig. 4.5), superficially similar to *Protosiphon* (p. 45), but differing in its forked rhizoid, and its ability to divide vegetatively. The multinucleate cells, reaching up to 2 mm (0.08 in.) in diameter and containing numerous disk-shaped chloroplasts, are frequently encountered on damp mud. *Vaucheria* (Fig. 4.6) is filamentous and branched, the single cell containing numerous nuclei and chloroplasts. The chloroplasts move in relation to light, the greatest exposure occurring at low irradiances. The action

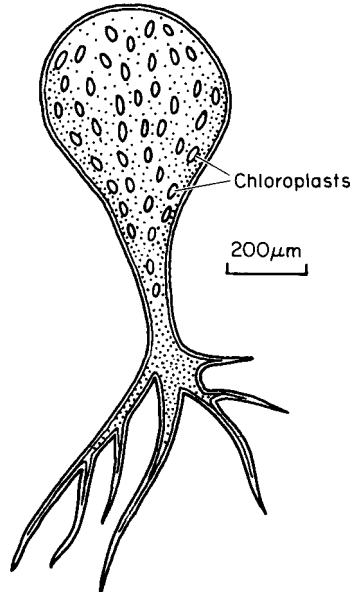

Figure 4.5 *Botrydium granulatum*.

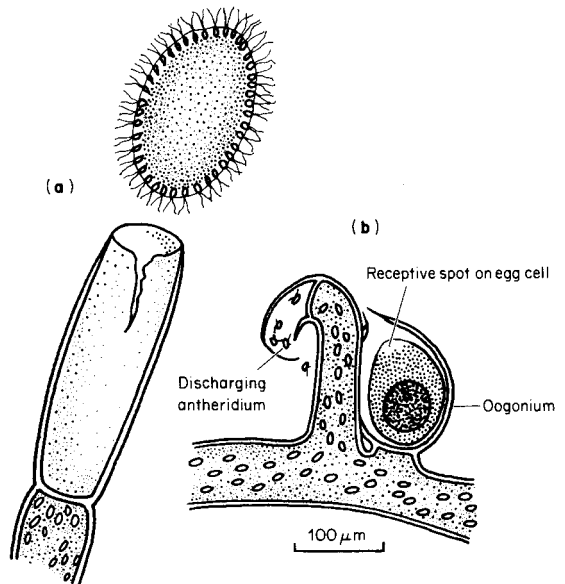

Figure 4.6 *Vaucheria*, reproductive organs. (a) Release of zoospore. (b) Gametangia.

spectrum indicates that the photoreceptor is probably a flavoprotein. Various species are found in fresh water and on damp earth, some becoming greenhouse pests. In terrestrial situations colorless rhizoids attach the thallus to the substratum.

Some species become encrusted with calcium carbonate and contribute to the formation of tufa.

Reproduction

Asexual reproduction in *Botrydium* is by heterokont zoospores generated and released when the parent plant is flooded. In dry conditions aplanospores may be produced, or even cysts, from the rhizoidal regions. *Tribonema* reproduces vegetatively by fragmentation of the filament and asexually by the production of biflagellate zoospores. These are produced singly or in pairs in the parent cells and released by separation of the two halves. In place of zoospores the cells of the filament may sometimes give rise to thick-walled aplanospores. As these germinate the protoplast enlarges and causes the wall to fall into two pieces revealing its structural similarity to the walls of the filament. Asexual reproduction in *Vaucheria* occurs frequently, and involves the formation of a peculiar zoospore (Fig. 4.6). The apical region of a filament, rich in oil droplets and plastids, is cut off by a transverse septum. The many nuclei within this segment migrate to the periphery of the protoplast, and opposite each nucleus emerges a pair of slightly unequal flagella. The tip of the filament becomes gelatinous, and a multiflagellate zoospore (synzoospore), which can be regarded as a mass of unseparated uninucleate zoospores, escapes. On coming to rest the flagella disappear, a wall is secreted, and the zoospore begins to germinate. Two or three filaments emerge from the spore, one of which usually acts as a holdfast. In some species, particularly the terrestrial, aplanospores lacking flagella are produced in a manner similar to that of the synzoospores. The spore is liberated by breakdown of the sporangial wall, and germination may begin before liberation is complete.

Sexual reproduction, involving isogamy, has been reported in *Tribonema* and *Botrydium*, but reaches its fullest expression in the oogamous *Vaucheria* (Fig. 4.6). The onset of the reproductive phase is indicated by the formation of antheridia. The tip of a lateral branch, in which many nuclei, but few plastids, accumulate, is cut off by a transverse septum. The cytoplasm becomes apportioned between the nuclei, and each uninucleate protoplast then differentiates into a biflagellate

gamete. Meanwhile the female organ develops, in many species next to the male on the same filament. Although the oogonium is initially multinucleate at maturity it contains a single uninucleate egg cell. When the egg is mature a short beak develops asymmetrically at the apex of the oogonium and the egg becomes accessible to the male gametes. Only one penetrates the egg cell, and its nucleus comes to lie by that of the egg, not fusing with it until it has swollen to an approximately equal volume. The zygote becomes surrounded by a highly impervious wall and may remain dormant for several months. Germination leads to the formation of a new filament. Meiosis appears to occur during formation of the gametes, the life cycle thus being diplontic.

Since in most species of *Vaucheria* fusion takes place between gametes from the same filament, sexual reproduction provides for little more than the interpolation of a resting stage in the life cycle. A few species, however, are dioecious, allowing the possibility of genetic recombination.

The limited evolution of the Xanthophyta

If, as seems probable, the Xanthophyta are the result of a line of evolution from some ancestral motile form, parallel to that of the Chlorophyta, the problem immediately arises of why the rate of evolution has been so much slower. It is possible that relatively infrequent sexual reproduction and its limitation to self-mating (as in most species of *Vaucheria*) have been a continuous feature of the Xanthophyta. This would have limited the opportunity for genetic recombination and the appearance of new forms. Biochemical features associated with the different pigmentation may also have restrained variation and evolutionary success. Fossil information about the evolution of the division is almost non-existent, but remains of minute coenocytic algae, closely resembling species of *Vaucheria*, have been found in deposits 900–1000 years old in eastern Siberia.

BACILLARIOPHYTA

Habitat Aquatic and terrestrial.

Pigments Chlorophylls *a*, *c*; β - (and possibly ϵ -) carotene; diatoxanthin, diadinoxanthin, fucoxanthin.

Food reserves Fat, chrysolaminarin.

Cell wall components Cells box-like, wall consisting of two halves, one half fitting over the other like a lid. Hemicelluloses, silica, often with a matrix of sulfated polysaccharides.

Reproduction Asexual and sexual (anisogamous and oogamous).

Growth forms Unicellular, colonial.

Flagella One Flimmer (in some forms lacking the central pair of microtubules); anterior.

(Present only in the male gametes of centric diatoms.)

The Bacillariophyta, commonly known as the diatoms, are a large division of microscopic algae with intricately sculptured, siliceous walls. The bilateral or radial symmetry of the cells, and the regularity of the delicate markings on their walls (Fig. 4.7), make the diatoms very beautiful microscopic objects, rivaling even the desmids.

The diatoms are frequent in freshwater and marine phytoplankton and are therefore of economic importance in the management of fisheries. Some species play a rôle in maintaining the nutritional status of the planktonic fauna and flora as a whole. The marine centric diatom *Rhizosolenia*, for example, forms mats, a few square centimeters in area, which rise and fall in the ocean (possibly in consequence of fluctuations in their content of starch). Investigation of samples in the Pacific has shown that rising mats are richer in nitrates and other minerals than falling mats. They evidently provide a supply of essential minerals to the surface from deeper waters. Nitrogen-fixing blue-green algae have also been found associated with *Rhizosolenia* mats. Other diatoms are benthic and live upon rocks or sand, or as epiphytes.

The siliceous walls of the diatoms resist dissolution and decay after the death of the organism, and those of the planktonic species accumulate as fossils on beds of lakes and seas (Fig. 4.7). Since the composition of the diatom flora is dependent upon pH of the water, floristic analysis of lake deposits can give an indication of environmental trends over a long period of time. Huge deposits of these "diatomaceous earths" (Kieselguhr) are known from the Tertiary era, and some are mined

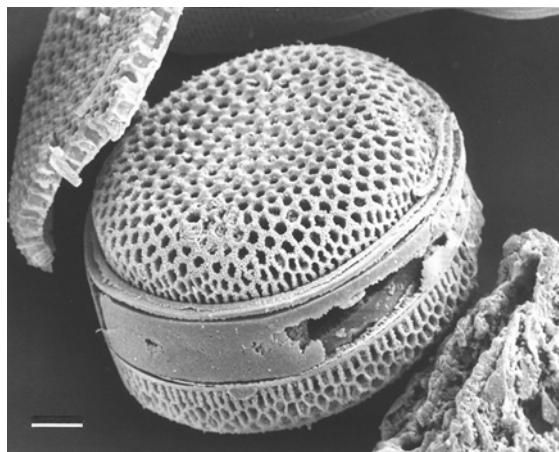

Figure 4.7 A fossil species of *Coscinodiscus* from a diatomaceous earth. Scale bar 10 μm . (Micrograph provided by J. Davy.)

for use as abrasives, filters and the refractory linings of furnaces.

Much study has been given to the cell wall of diatoms, and it is principally upon its characteristics that the classification rests. Although the several thousand species of diatoms occur in many different shapes, the walls of all consist basically of two parts which overlap like the halves of a Petri dish (Fig. 4.8). Consequently, the appearance of the cells from the side (girdle view) is different from that from above (valve view). Two principal orders, the **Centrales** (centric diatoms) and the **Pennales** (pennate diatoms), are distinguished by the difference in valve view. In the Centrales the valve is circular, triangular or polygonal, and in the Pennales elongate. The decoration of the valve of the centric diatoms follows a radial pattern, while in the pennate diatoms the lines of ornamentation lie parallel and transverse to the plane of symmetry of the valve. The intersection of the plane of symmetry and the surface of the valve is usually marked by a longitudinal fissure (*raphe*) at which there may be contact between protoplast and medium. The raphe is never present in centric diatoms. The sculpturing of the wall depends upon inequalities in the thickness of the outer siliceous layer. In some species pores may be present in the thinner regions.

Coscinodiscus, a genus containing both living and fossil species (Fig. 4.7), the former widely

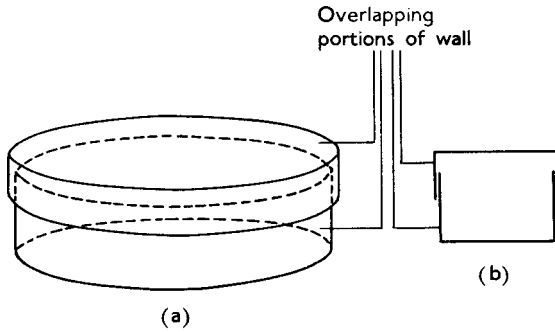

Figure 4.8 Diagrammatic representation of the arrangement of the two halves of the wall in a diatom. (a) Three-dimensional view. (b) Transverse section.

distributed in the oceans, is representative of the free-floating centric diatoms. *Melosira*, found in both freshwater and marine plankton, is colonial. The cylindrical cells remain attached valve to valve, forming many-celled filaments (Fig. 4.9a). In *Chaetoceras*, also filamentous, the valves have spine-like outgrowths which project from the sides of the filament and possibly assist flotation. The common free-floating pennate diatom of fresh water is *Pinnularia* (Fig. 4.9b). A similar marine organism is *Pleurosigma*, whose walls are so delicately and regularly sculptured that the valves are used as specimens to test the resolution of light microscopes. Colonial forms are *Asterionella* (Fig. 4.10), frequent in Windermere, in which the cells are grouped in star-like aggregates, and the marine *Licmophora*, where the cells form tree-like colonies. Another notable colonial pennate form is *Gomphonema*, commonly found as a slimy brownish coating on stones in running fresh water. The funnel-shaped cells are borne either singly or in pairs on sparingly branched cartilage-like stalks.

Many pennate diatoms are able to perform small jerky movements, often returning irregularly to their starting point. Although the mechanism of this movement is not entirely clear, it is believed to result from jets of mucilage which issue from the raphe. In some situations the secretion of mucilage, in which acidic hemicelluloses predominate, is continuous, and at times of diatomic blooms the mucilage may accumulate in considerable quantities. Cross-linking with the ions of metallic pollutants can lead to the forma-

tion of tough rubbery mats. Beaches in some parts of the Adriatic have been badly contaminated in this manner.

Within the cell the cytoplasm forms a thin layer containing one or more chloroplasts, usually brownish in color because of the accessory pigments (particularly fucoxanthin), surrounding a large central vacuole. In the centric diatoms the nucleus is also held in this peripheral layer, but in the pennate diatoms the nucleus is suspended in the center of the cell by a band of cytoplasm which traverses the vacuole. A few diatoms lack pigmentation and are heterotrophic (e.g., the pennate planktonic *Nitzschia*).

Reproduction

Simple asexual reproduction takes place by cell division. This involves the separation of the two halves of the wall, one half going to each daughter cell. Each daughter then immediately secretes another half wall, thus completing its envelope. Since the mature walls are quite inflexible, and each new half fits into a pre-existing one in the manner of the bottom half of a Petri dish into the top, the size of the cells inevitably decreases with successive vegetative divisions. Eventually a regeneration process occurs which is normally sexual. Conditions of depleted nutrition however may lead to the formation of resting spores. After two divisions of the starved cell, the second of which is unequal, the larger cell becomes the spore. The wall surrounding the spore is of the normal kind, but thicker.

Sexual reproduction in the centric diatoms is oogamous and meiosis occurs in the production of gametes. The antheridial cell produces four spermatozooids, each of which has a single Flimmer flagellum. An unusual feature of the flagellum is the absence of the two central tubules from the axoneme (p. 21). In the cell giving rise to the oogonium, one daughter nucleus of the first meiotic division degenerates, and also one of the second. The remaining nucleus, together with the whole of the cytoplasm, becomes the egg. After fertilization, which may be within or without the oogonium, the zygote surrounds itself with an extensible polysaccharide wall. It then grows to as much as four times its original size, forming an *auxospore*. Normal siliceous walls are then laid

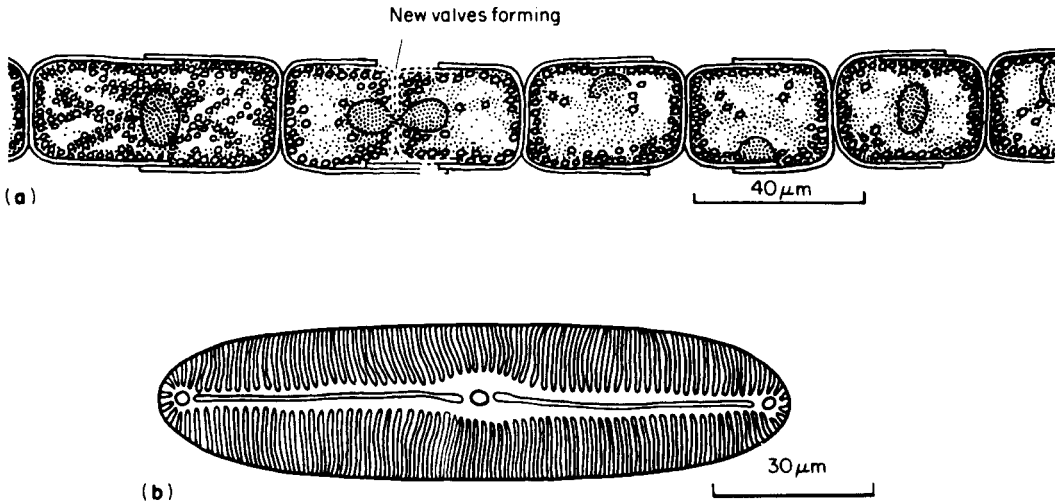

Figure 4.9 (a) *Melosira*. (b) *Pinnularia*. ((b) after Esser. 1976. *Kryptogamen*. Springer-Verlag, Berlin.)

amy), and formation of auxospores without sexual fusion (apogamy) has also been observed.

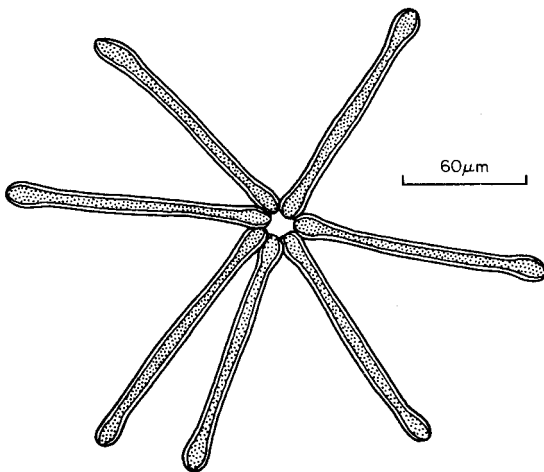

Figure 4.10 *Asterionella*.

down, and a renewed sequence of vegetative divisions, with progressively diminishing cell size, begins.

Reproduction of the pennate diatoms is isogamous. Two vegetative cells become held together in mucilage. The two nuclei divide meiotically, but only two products survive as gametes in each instance. The valves then open and the gametes (which lack flagella) fuse. As in the centric diatoms the zygotes grow into auxospores before the beginning of vegetative divisions. Sometimes two gametes of the same parent may fuse (autog-

Relationships

Although the Bacillariophyta share basic biochemical and metabolic features with the Xanthophyta and Chrysophyta (particularly with some chryomonads, see p. 76), and the hairs (mastigonemes) of the flagellum, when present, are very similar to those of the heterokont algae generally, the diatoms are clearly highly specialized. If a common ancestor existed, the Bacillariophyta probably diverged at an early stage. On the other hand, there are no well-established records of Paleozoic diatoms, and they do not appear in quantity until the later Mesozoic and Tertiary eras. This points to their origin having been at the close of the Paleozoic, and their major diversification toward the end of the Jurassic period. The earliest forms are centric, suggesting that the flagellate male gamete, found only in the centric diatoms, is a primitive feature.

PHAEOPHYTA

Habitat Predominantly marine.

Pigments Chlorophylls *a*, *c*; β -carotene; violaxanthin, fucoxanthin.

Food reserves Polyols (e.g., mannitol), laminarin.

Cell wall components Cellulose, hemicellulose, sulfated polysaccharides.

Reproduction Asexual and sexual (oogamous).

Growth forms Filamentous, parenchymatous. No free-living unicellular forms.

Flagella Two unequal, one smooth and one flimmer (sometimes spiny); usually lateral.

Of the many genera of the Phaeophyta (brown algae), only very few are freshwater, the remainder being seaweeds whose macroscopic flattened thalli are familiar inhabitants of the intertidal regions of rocky coastlines. Other genera inhabit the region just beneath the low-tide mark, some being found solely in mid-ocean.

The vegetative organization of the Phaeophyta surpasses that of any of the algae so far considered. The simplest thallus encountered in the division consists of branching filaments, and is heterotrichous, resembling in this respect the most complex filamentous forms found in the Chlorophyta. This generally morphologically advanced state is also reflected in the manner of reproduction. In the Phaeophyta oogamy is the general rule, and the alternation of phases in the life cycle is developed to the point where gametophyte and sporophyte begin to diverge morphologically. In the epiphytic *Desmarestia antarctica* the gametophyte is an endophyte growing in the medulla of the host, a red alga (*Curdiea*). Many pheromones, produced by the female gametangia and attracting the male gametes, have been detected in cultures of brown algae. The pheromones are mostly unsaturated hydrocarbons of fairly low molecular weight, often aromatic, and occasionally with cyclic regions in the molecule.

The number of chloroplasts in a cell varies from one to many, but is usually constant within a genus. As in the Cryptophyta a chloroplast endoplasmic reticulum, continuous with the outer membrane of the nuclear envelope, is a characteristic feature. The thylakoids are commonly in groups of three. Pyrenoids, where present, are often conspicuous, but are absent from the plastids of many advanced genera.

The flagella of the motile cells of the brown algae are borne laterally (Fig. 4.11), not apically as in most heterokonts. The posterior flagellum often has a swelling near the base which fits into a recess in the eyespot in the adjacent chloroplast (Fig. 4.11). The function of the eyespot is possibly to focus incident light on to photoreceptors in the

flagellar swelling, providing the cell with a phototactic mechanism. A similar arrangement is seen in the motile cells of other heterokonts, but is typically absent from the gametes of the Laminariales (p. 87).

The Phaeophyta are divided into at least twelve orders, but representatives of only the six commoner ones will be considered here. They will, nevertheless, fully illustrate the probable evolutionary trends in the development of the morphology and of the reproductive cycles of the brown algae.

The Ectocarpales

The Ectocarpales are represented by *Ectocarpus* (Fig. 4.12), mostly small heterotrichous plants resembling in habit the green alga *Cladophora* (p. 55), common along the Atlantic coast of America and in the colder seas of the northern hemisphere. Around ports and docks some forms have become tolerant of metal pollution, particularly of copper. In the erect filaments the division of the cells, which contain a few branching, ribbon-like chloroplasts, is limited to well-defined intercalary regions. This method of growth, frequent in the Ectocarpales, is termed "trichothallic". The common *Pylaiella* is very similar to *Ectocarpus* but tidal action often causes the axes to roll together, forming a characteristic cable-like bundle.

Other members of the order are more complex. *Ascocyclus*, for example, has an elaborate prostrate system, and in this respect resembles the green alga *Coleochaete*. The gelatinous cushion-like thallus of *Leathesia*, although appearing parenchymatous, is formed by the adhesion of filaments. A truly parenchymatous condition is reached in *Punctaria* (Fig. 4.13). Here cell division takes place in various directions and results in a leaf-like thallus closely resembling *Ulva*.

REPRODUCTION

The life history of *Ectocarpus* is well known (Fig. 4.14). In favorable environmental conditions the two phases, except in respect of the reproductive organs, are morphologically identical, but in colder regions the haploid plant may develop little, or even not at all. Reproduction of the diploid plant takes place solely by zoospores, but these are produced in two kinds of sporangia,

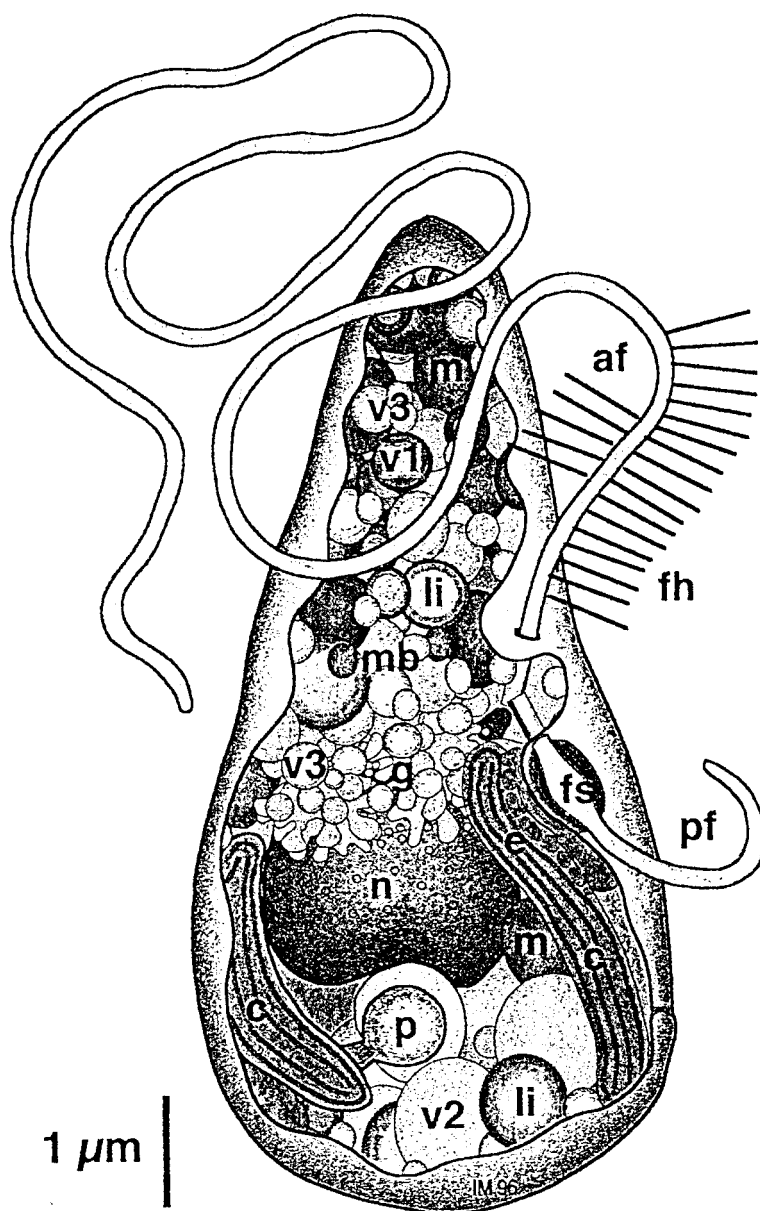

Figure 4.11 Diagrammatic representation of the male gamete of *Ectocarpus siliculosus*, showing the distribution of the cellular organelles: af and pf, anterior and posterior flagella respectively; fh, flagellar hairs (present along the whole length); fs, proximal swelling of the posterior flagellum; c, chloroplast; e, eyespot; g, Golgi body; n, nucleus; m, mitochondrion; p, pyrenoid; li, lipid body; mb, microbody; v1, v2, v3, vesicles with possibly different functions. (From Maier: 1997. *European Journal of Phycology* 32.)

phase, the zoospores settle and yield diploid plants identical with their parent.

The cytology of the developing unilocular sporangium is more complex. The nucleus of the initial cell is conspicuously large, and its first divisions are probably meiotic. Although the cytoplasm becomes multinucleate, no walls are formed, and it is only at maturity that the protoplast becomes divided into uninucleate portions. Each portion differentiates into a biflagellate zoospore. All are eventually released at an apical pore. Although these zoospores behave as those produced in plurilocular sporangia, they yield only haploid

termed respectively "plurilocular" and "unilocular" (Fig. 4.12). The plurilocular sporangia arise from cells which undergo repeated transverse and subsequently longitudinal division, giving rise to spindle-shaped groups of small, more or less cubical compartments, each of which at maturity contains a single biflagellate zoospore. The plurilocular sporangia are commonly either lateral, or terminate short lateral branches. Dehiscence is by an apical pore. Dissolution of the partitions allows the zoospores to escape. After a motile

plants. The haploid plants bear only plurilocular sporangia. These produce motile cells which behave either as zoospores, reproducing the haploid phase asexually, or as gametes. The zygote germinates without meiosis or production of zoospores, and grows directly into a diploid plant.

Aberrations of this cycle are frequent. In cold conditions the products of the unilocular sporangia may function directly as gametes. The gametophytic plant is then eliminated from the cycle. Unmated gametes have occasionally been

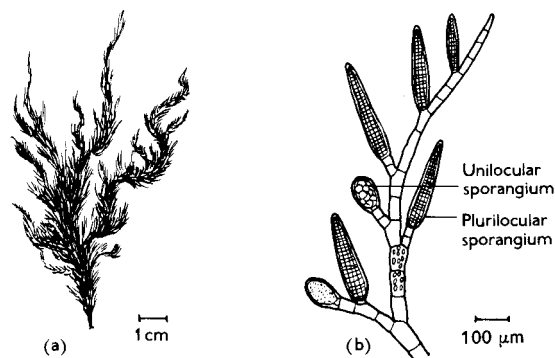

Figure 4.12 *Ectocarpus confervoides*. (a) Habit. (b) Sporangia. (After Newton. 1937. *A Handbook of the British Seaweeds*. British Museum, London.)

observed to give rise to plants bearing unilocular sporangia. This is an example of apogamy, the generation of a plant with the characteristics of the sporophyte from an unfertilized gamete.

Although most species of *Ectocarpus* are isogamous, two sexes are distinguished by the behavior of the gametes. Those regarded as female are the first to settle, and fertilization follows. The male and female gametangia are borne on different plants. Anisogamy has been detected in the more complex Ectocarpales. A pheromone has been detected in *Ectocarpus*, consisting of a seven-carbon ring with a short side chain. Although called “ectocarpene”, it is also produced by some other unrelated genera.

In some epiphytic species of *Ectocarpus* and *Pylaiella* the gametophytes and sporophytes, although similar, grow on different plants. The sporophytes of *Pylaiella littoralis*, for example, grow on *Fucus* and the gametophytes on *Ascophyllum*.

The Sphacelariales

Representative of the small order Sphacelariales, close to the Ectocarpales, is *Sphacelaria*, a heterotrichous alga ranging from polar to tropical seas. The upright filaments terminate in an apical cell conspicuous for its large size and brown pigmentation. Investigations have shown that photoperiod and temperature affects the form of the life cycle. Above 20 °C (68 °F) there is a tendency for the reproduction of both the gametophyte and the sporophyte to take place solely by multicellular propagules.

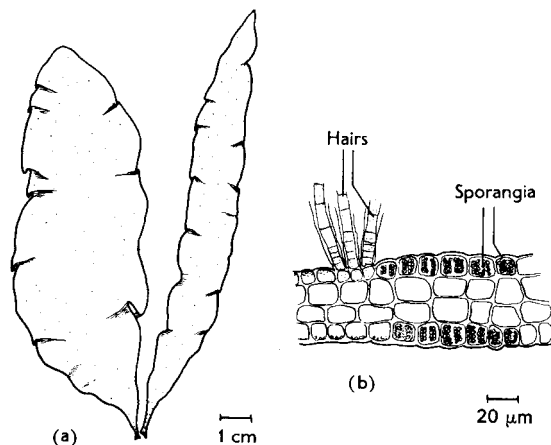

Figure 4.13 *Punctaria latifolia*. (a) Habit. (b) Transverse section of thallus with sporangia. (After Newton. 1937. *A Handbook of the British Seaweeds*. British Museum, London.)

The Cutleriales

Heterotrichous growth is also characteristic of the small order Cutleriales. The principal genus, *Cutleria*, is represented by a number of species in warmer seas of the northern hemisphere. There is a well-developed life cycle (Fig. 4.15), but only one component of the heterotrichous system is fully represented in each phase, so the cycle is markedly heteromorphic.

The sporophyte, which displays only the prostrate component, grows as an incrustation on rocks, and was originally regarded as a distinct genus, *Aglaozonia*. The unilocular sporangia, in which, as usual, meiosis occurs, are superficial, and yield haploid biflagellate zoospores. On settling, these become attached to the substratum by a sucker-like holdfast.

The gametophytes, which arise from the attached zoospores, consist principally of an erect filamentous system. The filaments run parallel and adhere to each other for much of their length, forming a pseudoparenchymatous thallus. For a short distance at the apex, however, the filaments are free, and here there is distinct trichothallic growth. The gametophytic phase of the Mediterranean *C. multifida* is dioecious (Fig. 4.15). The male and female gametes are both biflagellate and motile, but the male are minute compared with the female.

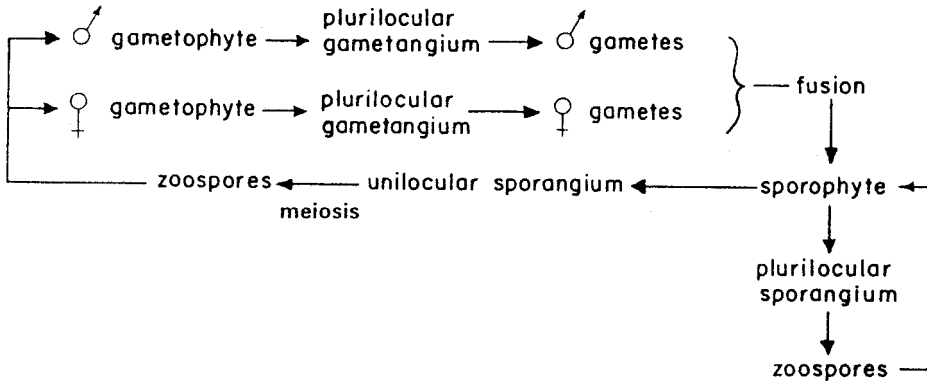

Figure 4.14 The life cycle of *Ectocarpus*.

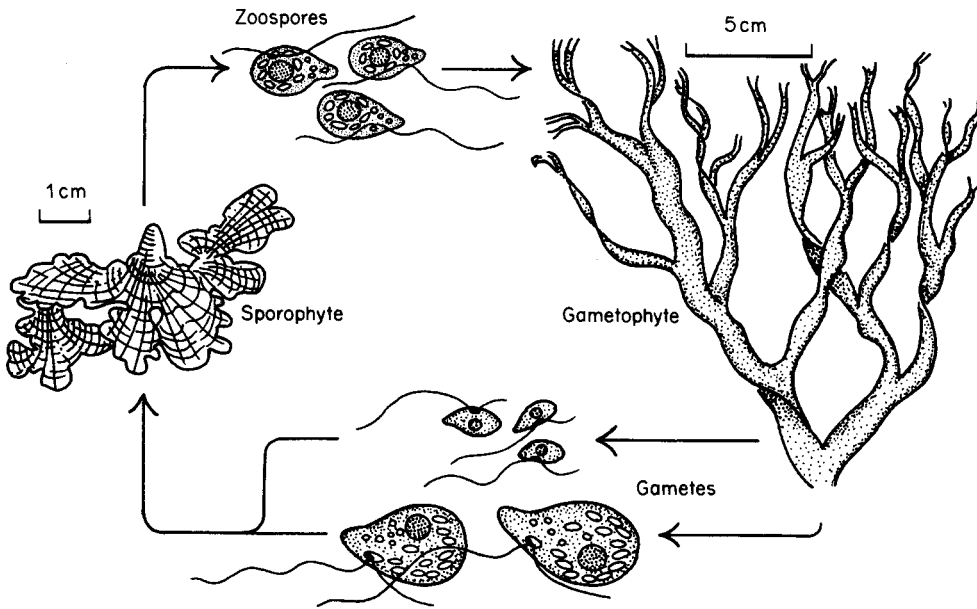

Figure 4.15 *Cutleria multifida*. Life cycle, showing both anisogamy and the striking morphological difference between gametophyte and sporophyte. The gametophyte, although only one is shown, is dioecious. There is segregation for sex in the formation of zoospores. Gametes and zoospores diagrammatic showing relative sizes. (After Esser. 1976. *Kryptogamen*. Springer-Verlag, Berlin.)

The Laminariales

The Laminariales, known collectively as kelps, include *Macrocystis* and *Nereocystis*, the largest known algae, sometimes reaching up to 60 m (197 ft) in length. Some species, such as *Undaria* (wakame) in Japan, are cultivated ("mariculture") for food, and others are harvested commercially as

sources of the mucopolysaccharide algin. This yields alginic acid, widely used as an emulsifying agent in the food and paint industries, and in the processing of rubber. Specimens of *Macrocystis* off the coast of Southern Australia grow by as much as 1 m (39 in.) a day, probably the fastest growth rate in the plant kingdom, although possibly approached amongst land plants by some bamboos (p. 305).

The Laminariales are usually found below low water mark, but a few are regularly exposed at low tide. An example of the latter is the striking *Postelsia* of the Pacific coast of North America, a species with an arboreal habit, suggestive of a miniature coconut palm. The sporophyte of the

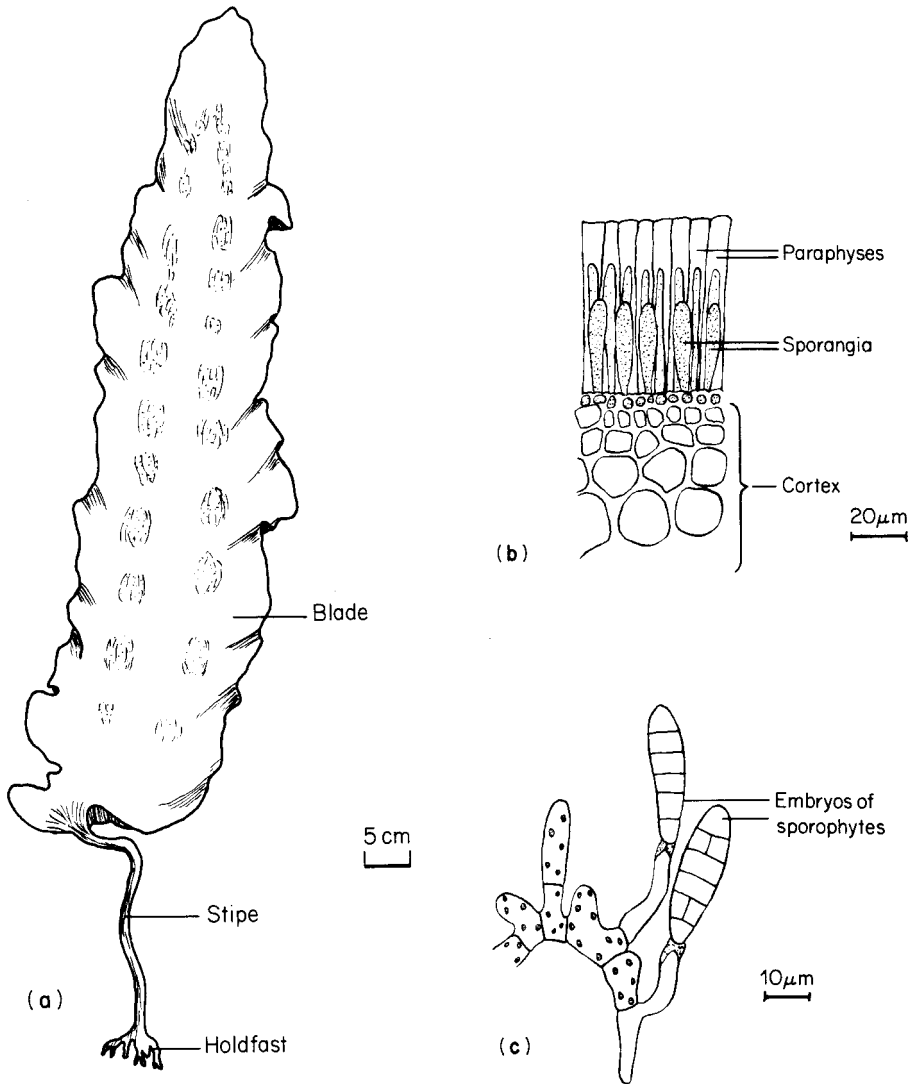

Figure 4.16 *Laminaria*. (a) *L. saccharina*, habit. (b) *L. cloustoni*, transverse section of fertile region of lamina. (After Newton. 1937. *A Handbook of the British Seaweeds*. British Museum, London.) (c) *L. digitata*, portion of female gametophyte. (After Sauvageau, from Fritsch. 1945. *The Structure and Reproduction of the Algae*, vol. 2. Cambridge University Press, Cambridge.)

remarkable *Chorda filum*, frequent along calmer coasts of the north temperate zone, resembles a cylindrical boot-lace, and can grow up to 5 m (16 ft) long. The cylinder is hollow. The resulting buoyancy is such that the thalli tend to be upright when immersed.

VEGETATIVE STRUCTURE

In *Laminaria*, which may be taken as representative of the order, the large thallus is differentiated into holdfast, stipe and blade (Fig. 4.16). Abrasion by tides and turbulence continually wears away the end of the blade, but the loss is made good by persistent growth from a meristematic region at the base. A transverse section of the tough, pliable stipe reveals three anatomically distinct zones. Chloroplasts are confined to an outer zone (meristoderm), covered by a layer of protective mucilage. Within the meristoderm, in which some cell division persists indefinitely, is a zone of paler, elongated cells forming a well-defined cortex. Toward the center of the stipe the

longitudinal walls become increasingly gelatinous, and at the center itself is a mucilaginous matrix (medulla) containing intertwined and branching filaments. The innermost part of the cortex and the medulla also contain columns of elongated cells broadened at each end, and hence referred to as “trumpet hyphae”. The transverse walls of these cells are often perforated by groups of pits, and are frequently callosed. These are features of the sieve plates of higher plant phloem. There is now indeed firm evidence that the trumpet hyphae of the laminarian *Macrocystis* have a phloem-like function and take part in the basipetal transport of assimilates. Gas conduits, formed by the separation of cells (schizogeny), also occur in the stipe.

REPRODUCTION

Reproductive areas, referred to as *sori*, develop on the blades at certain times of the year. The sori consist of many unilocular sporangia interspersed with thick, sterile, protective hairs (paraphyses) (Fig. 4.16b). Meiosis occurs in the development of the sporangia, and they eventually yield haploid zoospores. These in turn develop into haploid gametophytic plants, much smaller than, and totally different in morphology from, the highly organized sporophytes (Fig. 4.16c). The gametophytes are dioecious, and, since it has been shown in a number of instances that spores giving rise to male and female gametophytes are produced in equal numbers in a sporangium, it appears that sex determination is genotypic.

Although the gametophytes show a tendency toward heterotrichous growth, any cell seems capable of yielding a gametangium. Oogamy is fully developed, the oogonium producing a single egg which escapes at maturity through a pore at the apex of the cell. In *Laminaria angustata* the immature egg cell possesses flagella, but these are shed before the egg emerges. The egg cells never become entirely free, but remain seated in a cup formed by the thickened margins of the pore at the apex of the oogonium. The male plant produces a number of terminal antheridia, from each of which is liberated a single spermatozoid with two lateral flagella. Antheridia will not develop in the absence of blue light or in temperatures above 20 °C (68 °F). At maturity the oogonia produce a

pheromone, lamoxirene, which structurally resembles ectocarpene, but contains an oxygen atom. This pheromone not only attracts the male gametes, but also promotes the ripening and opening of the antheridia.

Following fertilization, the zygote secretes an external membrane and develops into a new sporophyte without any resting period. The young embryo may remain attached to the female gametophyte for a short period, but it is doubtful whether this represents anything more than purely physical adhesion.

There is no specialized asexual reproduction of either the haploid or the diploid generations. Aberrations of the life history, such as plants with the haploid chromosome number but with sporophytic morphology, have however been reported. Fragments of the sporophyte of *Laminaria digitata* and of other laminarians, when cultured in the laboratory, have been found to give rise to filamentous gametophytes (apospory). Unisexual cultures of the female gametophytes of *L. digitata* in similar conditions produce abnormal sporophytes parthenogenetically (apogamy). These sporophytes have nuclei with 2C, 4C or 8C ploidy levels (C represents the amount of DNA in the normal haploid nucleus). Possibly events of this kind occur sporadically in nature.

The Fucales

The Fucales, the various species of which are known as “wracks”, are probably the most familiar of all seaweeds, particularly in the British Isles. The intertidal (littoral) regions of rocky shores often show a number of distinct horizontal bands, each consisting of an almost pure stand of a member of the Fucales. *Fucus* (Fig. 4.17), *Pelvetia* and *Ascophyllum* are genera frequent in these habitats. Desiccation of the thalli during exposure to air is prevented by the secretion of mucilage, and photosynthesis probably continues during low tide. A few Fucales grow in deeper water, and some (e.g., *Sargassum*) are free-floating. Although principally confined to the warmer regions of the great oceans, a Japanese species of *Sargassum* has become naturalized along the English Channel. Air bladders in which the proportions of oxygen and nitrogen often differ from those of normal air are frequently present in the thalli of the Fucales.

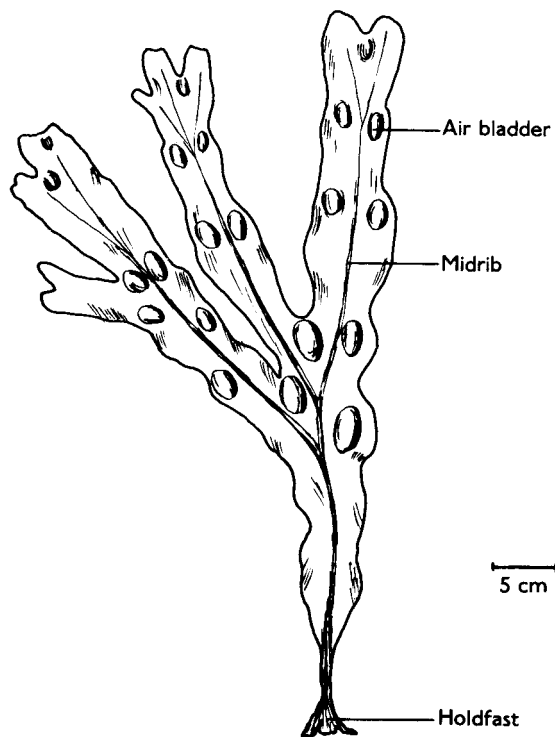

Figure 4.17 *Fucus vesiculosus*.

The thallus of *Fucus* is a much smaller structure than that of *Laminaria*, rarely exceeding 50 cm (20 in.) in length, but the differentiation into holdfast and blade is still evident. The flattened thallus is dichotomously branched and each branch grows from an apical meristem. The cells in the apical regions produce polyphenols. These are released on to the surface by discharge of vacuoles (exocytosis). The polyphenols are probably bacteriocidal and account for the freedom of the growing regions from adhering microorganisms. A distinct midrib usually lies at the center of each segment, branching in register with the thallus. Small cavities containing tufts of hairs (cryptostomata) are scattered in the marginal wings. The wings in the older parts are gradually worn away by the action of the sea until, in the region of the holdfast, only the midrib remains, giving the impression of a short stipe (Fig. 4.17). Small, densely branched ecotypes of *Fucus* often form swards in salt marshes subject to periodic inundation.

An interesting discovery has been that the

common brown seaweed *Ascophyllum nodosum* is regularly systemically infected with an ascomycete, *Mycosphaerella ascophylli*. Cultures from zygotes free of the fungus do not develop normal morphology. *Ascophyllum nodosum*, as it normally occurs, could thus be regarded as equivalent to a lichen.

REPRODUCTION

Both monoecious and dioecious species occur. In both, the reproductive structures form at the apices and these in turn become swollen with mucilage.

Microscopic examination reveals flask-shaped invaginations (conceptacles) in this swollen region, some of which contain female gametangia and others male, both interspersed with paraphyses (Figs. 4.18 and 4.19). Meiosis occurs during gametogenesis. The gametes are liberated at high tide.

As in the Laminariales, oogamy is fully developed, but in *Fucus* the eight eggs produced in an oogonium become quite free and drift passively in the sea. The spermatozoids, each of which has two lateral flagella, are attracted to the eggs. The pheromone (fucoserratene), produced by the female oogonia, is a straight-chain hydrocarbon. Fertilization of the *Fucus* egg was probably the first example of sexual fusion in plants to be observed under the microscope. Although hybrids have been described, fertilization in experimental conditions is species-specific and depends upon a glycoprotein recognition system on the surfaces of the egg and spermatozoid. Eggs treated with fucose-binding lectins, for example, are fertilized far less readily, presumably because of masking of the binding sites. Investigations with monoclonal antibodies to sperm surface antigens show that these binding sites are species-specific.

Following fertilization the zygote continues to drift and secretes a mucilaginous envelope. It eventually settles, becomes anchored by the mucilage, and germinates. The first division of the zygote establishes the polarity of all subsequent growth, since one daughter cell gives rise to the rhizoid (and ultimately the holdfast) and the other to the blade. It has been found experimentally that if the zygote is allowed to germinate in an environment that is not uniform, such as in a

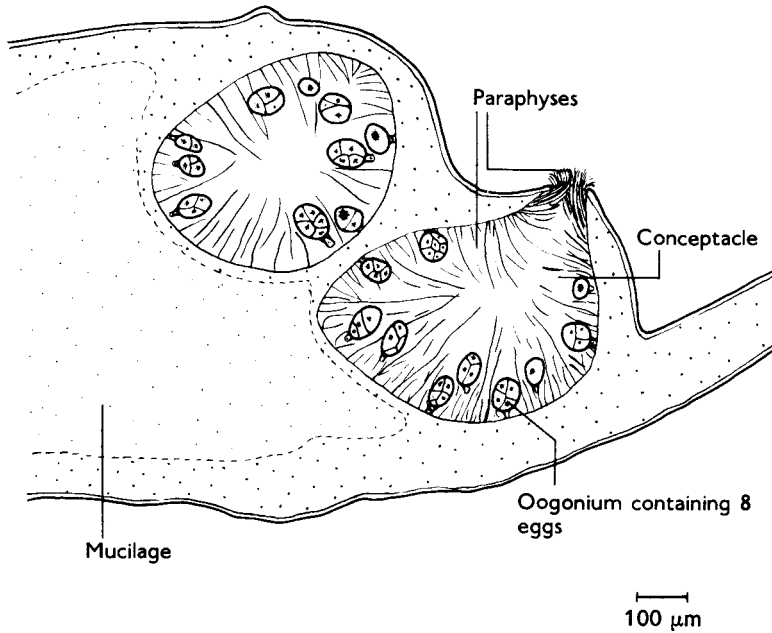

Figure 4.18 *Fucus vesiculosus*.
Transverse section of thallus with
female conceptacles.

gradient of light, temperature or hydrogen ion concentration, the dividing wall always forms transversely to the direction of the gradient. The subsequent behavior of the daughter cells depends upon the nature of the gradient. With a gradient of temperature, for example, the cell on the warmer side yields the rhizoid, and with a gradient of light, the cell on the darker side. In nature, of the two cells formed in the first division of the zygote, the rhizoid usually

develops from that in greater contact with the substratum. It seems likely that the orientation of this first division under natural conditions is determined by a combination of the environmental gradients that have been found effective in influencing the polarity in laboratory cultures.

Once polarity is established, a minute electric current passes through the embryo parallel to the axis, the rhizoid pole becoming increasingly negative. This current naturally influences the distribution of ions and charged molecules within the embryo, and may promote regional differentiation. In *Pelvetia* (closely allied to *Fucus*) calcium ions move into the tip of the growing rhizoid. In *Fucus spiralis* it has been shown that, once polarity is established, it is registered in the cell wall. A protoplast from the apical portion of a two-celled embryo, brought into contact with the wall from the basal portion, develops into a rhizoid. This is one example of the evidence now emerging that cell walls have an important rôle in determining cell fate in the development of multicellular plants.

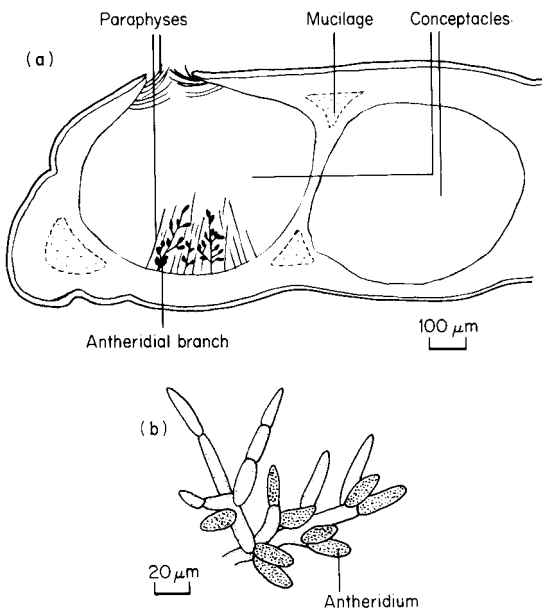

Figure 4.19 *Fucus vesiculosus*. (a) Transverse section of thallus with male conceptacles. (b) Portion of antheridial branch. ((b) after Thuret, from Fritsch. 1945. *The Structure and Reproduction of the Algae*, vol. 2. Cambridge University Press, Cambridge.)

INTERPRETATION OF THE LIFE HISTORY OF THE FUCALES

Two different interpretations have been made of sexual reproduction in *Fucus* and other Fucales. One brings it into line with that of the

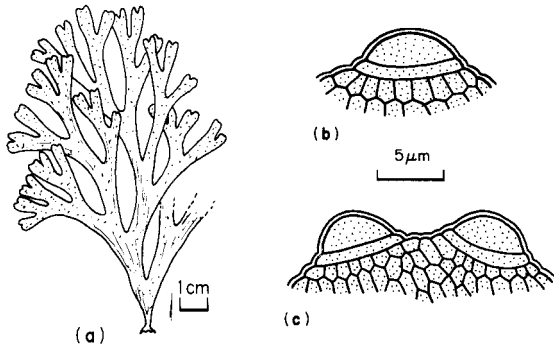

Figure 4.20 *Dictyota*. (a) Habit. (b) Apical cell. (c) Incipient dichotomy of the thallus.

Laminariales, interpreting the gametangia as homologous with unilocular sporangia, the gametophyte being reduced to nothing more than a gamete. The other draws an analogy with sexual reproduction in animals such as man, where there is no question of an independent haploid phase.

There is no specialized asexual reproduction in the Fucales, but fragments of thalli may regenerate in favorable conditions yielding independent plants. The free-floating species of *Sargassum* and the salt marsh forms of *Fucus* probably reproduce solely in this manner. Aberrations of the life history, such as apogamy, appear to occur rarely, if at all.

The Dictyotales

The thallus of *Dictyota* (Dictyotales), a widely distributed genus, is flattened and dichotomously branched, each branch growing from a conspicuous apical cell (Fig. 4.20). The thallus is only three cells thick, lacking a midrib. The two outer layers of cells are assimilatory, and the central one, consisting of large cells, may act as a storage region. The aerial parts of the thallus arise from a cylindrical rhizome, anchored to the substratum by tufts of rhizoids, and also showing apical growth.

REPRODUCTION

Sexual reproduction results in an isomorphic alternation of generations. Unilocular sporangia arise scattered or in groups over the surface of the diploid plant, and each yields, as a consequence of meiosis, four non-flagellate tetraspores (Fig. 4.21), a feature which distinguishes the Dictyotales

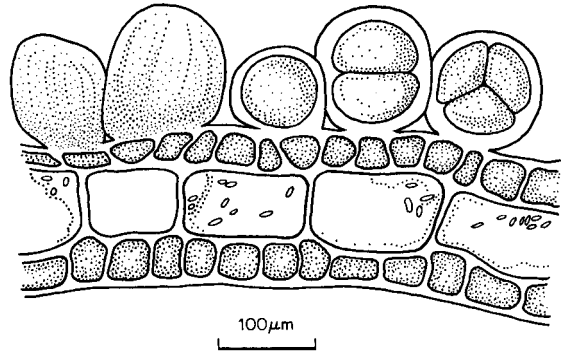

Figure 4.21 *Dictyota*. Sporophyte producing tetrasporangia.

from all other brown algae. During meiosis in *Dictyota* there is a 2:2 segregation for sex, and consequently male and female gametophytes are present in approximately equal numbers. In other genera the gametophytic phase is commonly monoecious.

The oogonia and antheridia are produced in groups (sori) on the surface of the thallus. Each oogonium produces a single egg which, like that of *Fucus*, drifts passively in the water when released. The antheridia are plurilocular, and the sorus is surrounded by a ring of sterile cells. The spermatozoids (antherozoids) have a single lateral flagellum (Flimmer), but electron microscopy has shown that a second is present as a rudiment enclosed in the cytoplasm, recalling the situation in some uniflagellate Chrysophyta (p. 75). Spermatozoids are attracted to the egg by a pheromone, now known to be a complex hydrocarbon similar to ectocarpene (p. 86). The zygote germinates very soon after fertilization.

There is no specialized asexual reproduction of either phase of the life cycle in *D. dichotoma*. Nevertheless in the genus *Homoeostichus* zoospores have been reported. These are ovoid, 40–55 μm in diameter, and bear two flagella. They are the largest known reproductive cells of any marine macroalga.

Relationships of the Phaeophyta

The Phaeophyta are a circumscribed division of the algae and little can be said of their wider relationship since no forms are known simpler than the Ectocarpales. They presumably arose from some primitive flagellate ancestor, and proceeded

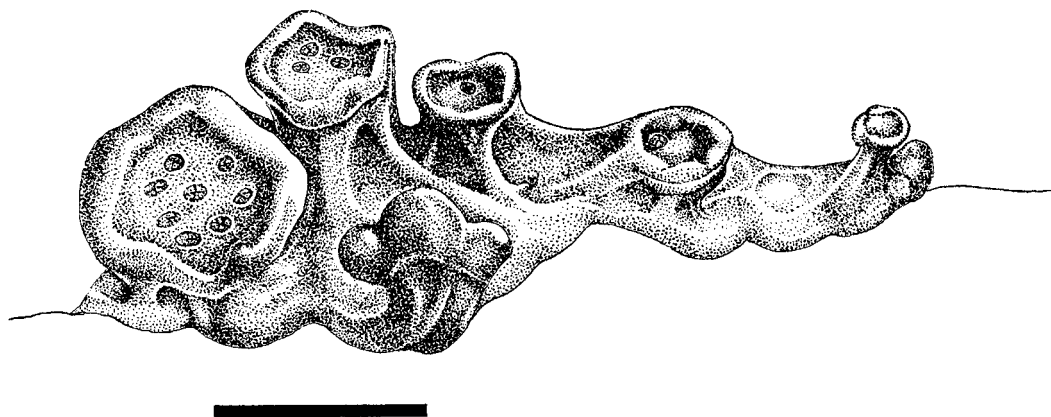

Figure 4.22 *Protosalvinia*, generalized reconstruction. Scale bar 2 cm. (After Niklas and Phillips. 1976. *American Journal of Botany* 63.)

to exploit a particular kind of pigmentation and metabolism that proved especially satisfactory in marine environments. It is striking that the furoid form appears to have an extremely long history. Compressed seaweeds in late Proterozoic shales (c. 570 million years old) in the Yangtse Gorges can be attributed with fair confidence to the Fucales.

There is no evidence that the Phaeophyta have ever contained forms becoming successfully adapted, as some of the Chlorophyta, to terrestrial life. The few varieties of the Fucales (e.g., *Fucus vesiculosus* var. *muscoides*), all of limited reproductive capacity, which occur in salt marshes mixed with halophytic flowering plants appear to be instances of specialization without any far-reaching significance. Nevertheless, in Paleozoic times there may have been abortive attempts on the part of brown algae to become land plants. *Protosalvinia*, for example, of the Upper Devonian, probably a plant of shore lines, was thalloid (Fig. 4.22) and showed *Fucus*-like branching. It produced thick-walled spores in tetrads in what have been interpreted as terminal conceptacles. *Prototaxites*, also Devonian, consisted of trunk-like stems with a pseudoparenchymatous organization similar to that of some brown algae. They may have been the stipes of a transmigrant kelp. The affinity of both these plants remains, however, in doubt.

It is noteworthy that photosynthesis in *Laminaria*, which often dominates a pelagic

canopy of marine algae, becomes light saturated only at high irradiances. This is a characteristic of “sun plants” of land vegetation, and is perhaps the consequence of an analogous specialization of the photosynthetic system.

HAPTOPHYTA

Habitat Mostly marine.

Pigments Chlorophylls *a*, *c*; β -carotene; fucoxanthin, diadinoxanthin, diatoxanthin.

Food reserves Fat, chrysolaminarin (in vacuoles).

Cell wall components Cellulose, hemicellulose, sometimes calcium carbonate in the form of calcified scales (coccoliths).

Reproduction Asexual, but life cycles little known.

Growth forms Unicellular, some colonial.

Flagella Typically two, mostly smooth, equal or unequal, usually with a third (haptonema) lying between them.

The Haptophyta (Prymnesiophyta) are distinguished by the *haptonema*, a flagellum-like organ of variable length. In some forms it is longer than the flagella. Although often coiled up like a proboscis (Fig. 4.23), it may in some species serve to attach the cells to the substratum, and in others (notably the partly phagocytic *Chrysochromulina*) act as a foraging device, trapping small algae (e.g., *Chlorella*) and bacteria. In transverse section the haptonema shows three concentric membranes enclosing a number of microtubules. The outer membrane is continuous with the plasmalemma and the inner pair represent a tubular extension of the endoplasmic reticulum.

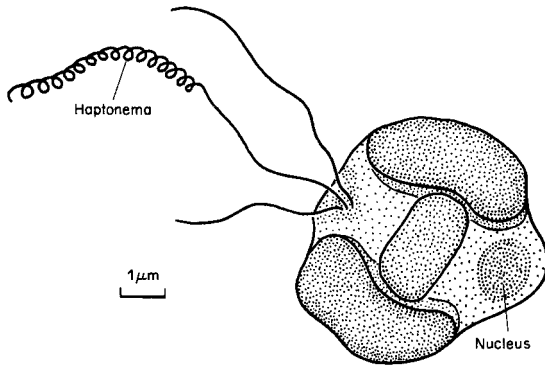

Figure 4.23 *Chrysochromulina* showing the haptonema between the flagella. The two parietal chloroplasts, central chrysolaminarin (leucosin) granule, and nucleus are also indicated. (After Scagel, Bandoni, Rouse, Schofield, Stein and Taylor. 1966. *An Evolutionary Survey of the Plant Kingdom*. Wadsworth, Belmont.)

The Haptophyta are largely marine and planktonic. Some (particularly *Chrysochromulina* spp.) are responsible for toxic “blooms” causing the widespread death of fish. The remarkable coccolithophorids also belong to the Haptophyta. The walls of these organisms are closely beset with delicately sculptured plates of calcium carbonate. These are first laid down in Golgi vesicles and then excreted to the exterior. Deposits of these scales from dead organisms (coccoliths) form the principal component of calcareous rocks such as the chalk of the Cretaceous period (Fig. 4.24). It has been estimated that chalk contains up to 800×10^6 coccoliths in 1 cm^3 . The marine coccolithophorid *Emiliana huxleyi* is currently the most abundant calcifying organism on Earth. It also forms vast blooms. As a consequence of the reflectivity of the calcified scales, these can be seen from the air, and even from satellites. *Emiliana* cells contain the osmoregulant dimethylsulfoniopropionate (DMSF). As the blooms die and are devoured by grazers, this compound decomposes and releases gaseous dimethylsulfide (DMS) into the atmosphere. The DMS is in turn oxidized, yielding an aerosol of sulfuric acid. In this way *Emiliana* contributes significantly to the sulfur content and acidity of the Earth’s atmosphere. *Phaeocystis*, a non-calcareous haptophyte which forms banks of foam (particularly on beaches in the southern North Sea), is also a notable source of DMS.

Haptophytes, including coccolithophorids, rich in fats may also have contributed to oil deposits formed in Cretaceous times.

Reproduction

Asexual reproduction probably predominates amongst the haptophytes, motile stages often alternating with non-motile ones. Similar non-motile forms, particularly of the coccolithophorids, often have dissimilar motile stages, a feature which makes a knowledge of the life history essential for classification.

In some instances there is evidence of a sexual cycle, a coccolith-bearing diploid stage alternating with a small haploid filamentous plant. This may reproduce itself by swarmers, or produce gametes.

DINOPHYTA

Habitat Aquatic, frequently planktonic.

Pigments Chlorophylls *a*, *c*; β -carotene; peridinin, dinoxanthin, other xanthophylls less prominent; in a few, phycobilins.

Food reserves Starch (formed outside the chloroplast), fats.

Cell wall components Cellulose, hemicellulose.

Reproduction Asexual, rarely sexual (probably isogamous).

Growth forms Mostly unicellular, a few coccoid or filamentous.

Flagella Two, apical or lateral, both with fine lateral hairs, or one smooth. In some forms flagella lacking.

The Dinophyta (Pyrrophyta) are predominantly unicellular planktonic organisms, with walls characteristically furnished with longitudinal and transverse furrows. Although there are ultrastructural characteristics common to the whole division, two classes have been recognized by some, the Desmophyceae and the Dinophyceae. The Desmophyceae are notable for having cell walls consisting of two watchglass-like halves. The edges are sometimes extended as elaborate borders, possibly assisting flotation. The flagella originate at the anterior end of the cell.

Although the Dinophyceae include some parasitic amoeboid forms, typically the cell walls, especially those of the dinoflagellates, are reinforced

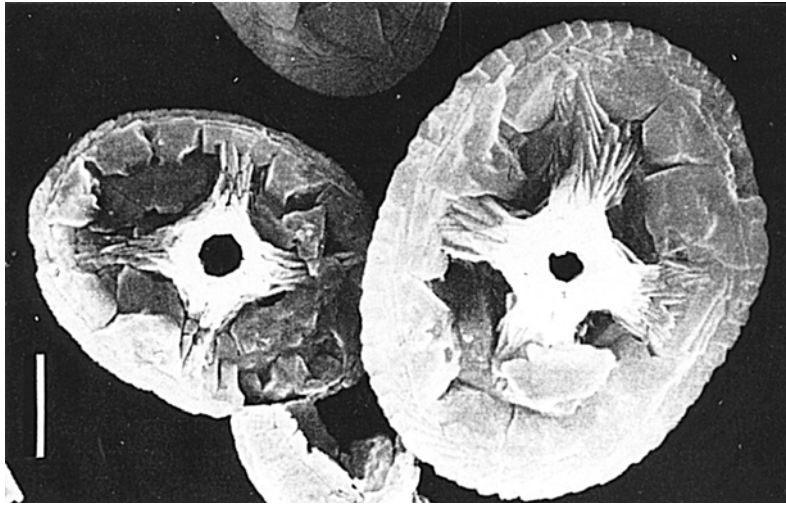

Figure 4.24 *Eiffelithus eximus*, a coccolith from the Cretaceous. Scale bar 2 μm . (Micrograph provided by A. J. J. Rees.)

with hexagonal polysaccharide plates (Fig. 4.25), forming the *theca*. Polymerized dipterene may also be present in the thecae of some species. The arrangement of the flagella in the dinoflagellates is unique. The attachment is lateral. One flagellum, usually smooth, is directed toward the posterior and its undulations push the

cell forward. The other flagellum, usually Flimmer, lies in the transverse groove. This flagellum may serve to stabilize the cell, and improve the effectiveness of the extended flagellum. It has been observed that when the transverse flagellum is inactive the cell rotates in one direction, and when it is active, in the converse direction.

The cells of the Dinophyta contain one or more chloroplasts, often (where the chloroplast is not suspected of being an endosymbiont) dark brown in color as a consequence of a large amount of the pigment peridinin. The chloroplast envelope consists of three membranes, a feature found elsewhere only in the Euglenophyta, and, also as in the Euglenophyta, the thylakoids are characteristically in stacks of three. A stigma is often present in the motile species and in zoospores. Many species lack pigmented plastids and live heterotrophically, while others are fully pigmented and form symbiotic associations with invertebrates (e.g., *Amphidium klebsii*, which is also free-living, in the flatworm *Amphiscolops*). Yet other dinoflagellates draw their photosynthates from what appear to be endosymbiotic unicellular forms which may be assignable to the cyanophytes, chlorophytes or other divisions of the algae. In *Peridinium*, for example, it appears that the original endosymbiont was a chrysophyte (p. 75). These (probably comparatively recent) associations with endosymbionts from various sources may account for the occasional reports of a chlorophyll other than *c* accompanying chlorophyll *a* in the dinophytes.

The nuclei of the dinoflagellates are peculiar

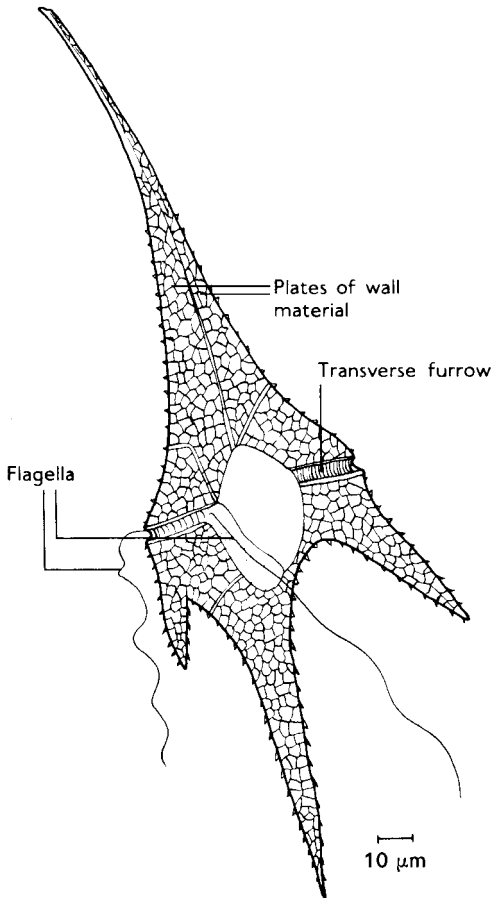

Figure 4.25 *Ceratium hirundinella*. (After Schilling, from West and Fritsch, 1927. *A Treatise on the British Freshwater Algae*. Cambridge University Press, Cambridge.)

in containing chromosomes which remain spiralized throughout the nuclear cycle and which, like those of prokaryotes, are deficient in histone proteins. Although earlier investigations suggested that during population growth DNA synthesis was continuous (as commonly in the prokaryotes), later work with synchronized populations has revealed a distinct S-phase in the nuclear cycle, as in eukaryotes generally. Many dinoflagellates on being irritated emit *trichocysts*. These are narrow proteinaceous needles or coils, partly crystalline, which first appear in Golgi bodies and emerge to the exterior through fine pores. This protozoan feature is encountered sporadically amongst the unicellular flagellate algae.

Many dinoflagellates, including those involved in blooms, such as the “red tides” of the Gulf of Mexico, produce toxic metabolites. Millions of cells may be present in a single liter of surface water, and the products of the toxic species cause widespread death of fish, dolphins and invertebrates. They may also be accumulated by shellfish and affect man. A common component of red tides is the dinoflagellate *Gymnodinium breve*, from which the neurotoxin brevetoxin B has been isolated. Species of the widely distributed *Gonyaulax* yield the highly toxic saxitoxin, which, if taken in with mussels and clams, can cause paralytic poisoning. Ciguatoxin, produced by *Gambierdiscus toxicus*, frequent in warmer seas near remote islands and off-shore reefs, enters the tissues of reef fish and causes the illness known as “ciguatera”, believed to affect up to 20000 people each year in the Caribbean alone. Some dinophyte toxins are soluble in cell lipids, and if ingested by humans can have long-term effects. A few dinoflagellates, principally of warmer seas, exhibit bioluminescence. *Noctiluca* is a well-known example. It is naked and wholly heterotrophic, feeding on blooms of other dinoflagellates. Some dinoflagellates emit flashes of light when cultures are shaken, and can sometimes illuminate breaking waves.

Although motile unicellular forms predominate in the Dinophyta, a few planktonic representatives are coccoid, and in the genera *Dinothrix* (known only from marine aquaria) and *Dinoclonium* the cells, which lack flagella, are aggregated in short, sparsely branched filaments.

Reproduction

In the motile species reproduction is only by simple vegetative division. In armored forms the theca may be either shed and then re-formed around the daughter cells, or split into two and then restored after division. Zoospores are produced by the coccoid and filamentous forms. Many dinoflagellates produce thick-walled cysts in unfavorable conditions. Although many sink and are lost, others remain sufficiently near the surface to germinate when conditions improve. These provide the “seed” for ensuing blooms. The cysts are distinctive and are well known as fossils from the Triassic onward (Fig. 4.26).

Sexual reproduction, both isogamous and anisogamous, is known in the dinoflagellates. The zygotes either germinate immediately or form resting cysts. In most instances meiosis occurs on germination; *Noctiluca* is unusual in being diploid.

The Dinophyta are clearly a highly specialized assemblage. The three membranes bounding the chloroplast suggest (as in the Euglenophyta, p. 74) an endosymbiotic origin of this photosynthetic compartment in the division as a whole, in addition to the more clearly defined cases mentioned earlier.

CRYPTOPHYTA

Habitat Aquatic, both marine and freshwater.

Pigments Chlorophylls *a*, *c*; α - (and rarely ϵ -) carotene; alloxanthin, other xanthophylls less prominent; biliproteins (phycoerythrin, phycocyanin).

Food reserves Starch, formed outside the chloroplast but near the pyrenoid.

Cell wall components Naked, but a pellicle may be present consisting of proteinaceous plates.

Reproduction Asexual, sexual doubtful.

Growth forms Flagellate, palmelloid stages occur.

Flagella Two, anterior, Flimmer, slightly unequal.

This division includes a few species, referred to collectively as cryptomonads, occasional in freshwater and marine phytoplankton. They are unicellular and biflagellate, in some forms one of the flagella being directed toward the posterior. The flagella are inserted at one side of a depression

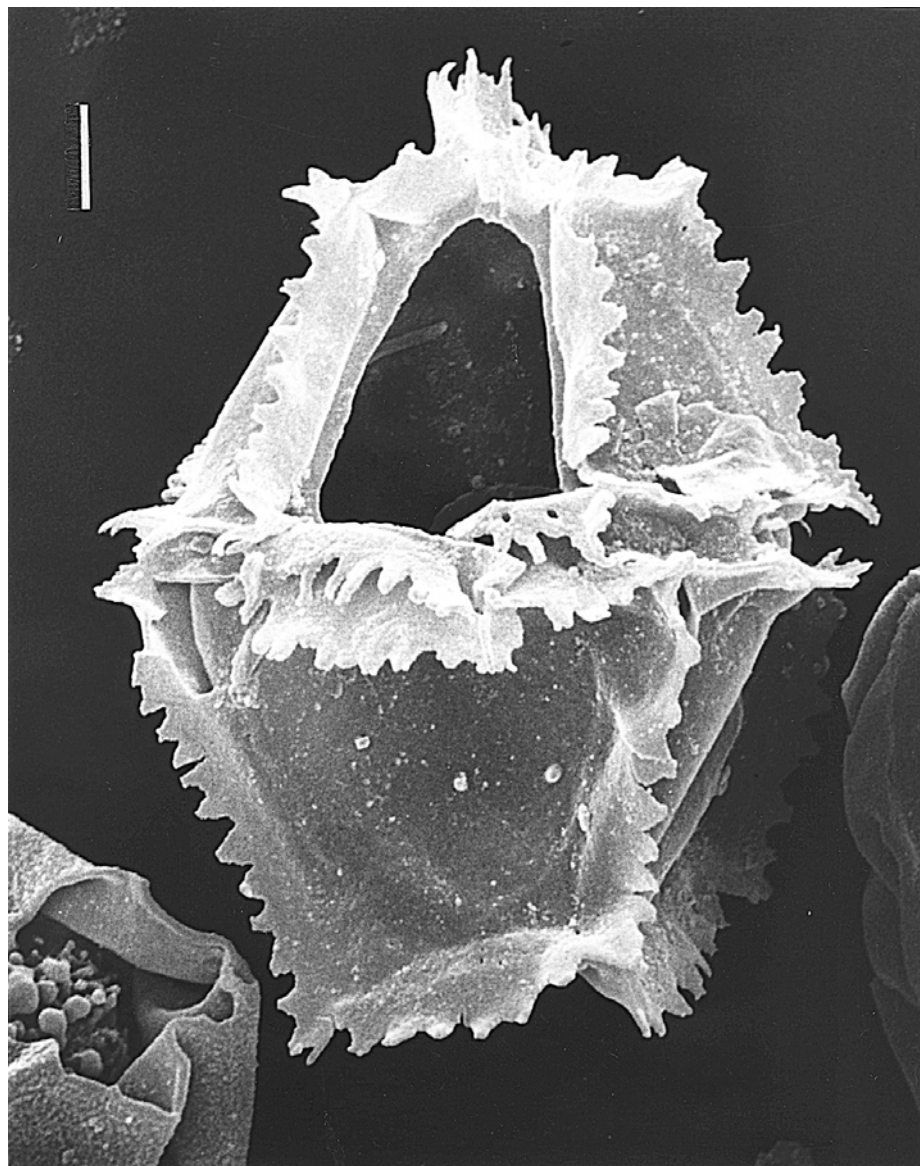

Figure 4.26 *Gonyaulacysta helicoidea*, a dinoflagellate cyst from the Upper Jurassic. Scale bar 5 μm . (Micrograph provided by J. Davy.)

(“gullet”) lined with refractive granules (Fig. 4.27). These are the site of “ejectosomes” which function in a manner analogous to that of the trichocysts of the dinoflagellates (p. 96). The color of the cryptomonads is variable depending upon the proportion of accessory pigments in the chloroplasts. These are commonly cup-shaped, and are bounded not only with the usual two membranes, but also (as in most of the heterokont algae) with a sheet of

chloroplast endoplasmic reticulum. The thylakoids are widely spaced, but less so than those of rhodophyte plastids. The biliproteins are not in the form of discrete phycobilisomes. A body termed a “nucleomorph” lies between the chloroplast and the surrounding endoplasmic reticulum. It is bounded by two membranes and contains DNA, and may represent the nucleus of an ancestral eukaryotic endosymbiont, possibly a red alga. Starch, although closely associated with the pyrenoid, lies outside the chloroplast but within the chloroplast endoplasmic reticulum (Fig. 4.27).

Although clearly properly placed in the “*a + c*” algae, the wider relationships of the Cryptophyta are obscure. The Cryptophyta are the only group of algae, apart from the Cyanophyta, Glaucophyta and Rhodophyta, to contain biliproteins as accessory photosynthetic pigments. The only well-established means of reproduction is by fission.

Evolutionary trends within the algae

From the foregoing survey of the principal features and interrelationships of the algae, we can now proceed to a consideration of the evolutionary and morphological trends displayed by the algal kind of organization as a whole.

Aquatic habitat and evolutionary change

A point of general significance in relation to the evolution of the algae arises from their predominantly aquatic habitat. One of the main factors influencing evolution within the plant kingdom has undoubtedly been environmental change. Nevertheless, aquatic plants, particularly those that are marine, are to some extent protected from such change, at least in a catastrophic form. The volume of the sea in particular is so vast that changes in such features as salinity and temperature must of necessity be gradual. Algae, therefore, have exploited to an extent greater than that of any other component of the world’s vegetation an environment which demands only comparatively slow adaptation to changing conditions. This possibly accounts for the persistence of numerous states of algal organization intermediate between the simplest unicellular and the complex multicellular, and of simple isomorphic life cycles (as in *Ulva* and *Ectocarpus*) without spores or zygotes suited to withstand unfavorable periods.

Closer inspection of individual groups reveals, of course, that continuity of structure and pattern is to some extent illusory. The Florideophycidae amongst the Rhodophyta and the Charales amongst the Chlorophyta provide examples of the numerous groups of living algae which lack close relatives. Nevertheless the groups themselves, having inhabited a relatively constant environ-

ment over periods of geological time, give a clearer indication of the paths evolution has taken than is often possible with land plants.

Antiquity of the algae

Geological evidence undoubtedly points to the algae being an extremely ancient form of life. Calcareous nodules (*stromatolites*) structurally similar to those produced by some living blue-green algae (e.g., *Lithomyxa*), are known from beds of Precambrian age, possibly over 2500 million years old. Filamentous remains, containing organic matter and suggestive of blue-green or even green algae, have been found in Precambrian rocks not less than 2000 million years old. Possible coccoid forms of blue-green algae have been described from even older rocks. The record of algal life begins about 3000 million years ago.

Naturally fossilization has favored those algae with calcareous skeletons. Remains of the calcified Siphonales, for example, are found in the mid-Proterozoic (Table 1.1), and the record continues (with evidence of increasing complexity) into the Mesozoic. Similarly the calcareous Rhodophyta appeared in the Cambrian, and were well represented by the Ordovician. The fossil record is thus to some extent biased. Nevertheless, current techniques are able to extract identifiable remains of coccoid and filamentous eukaryotic algae from rocks almost as ancient as those bearing calcified forms.

The fossil record, although admittedly still very fragmentary, fully supports the view that prokaryotes preceded eukaryotes (perhaps by as much as 1000 million years), and that simple unicellular and filamentous algae preceded the pseudoparenchymatous and parenchymatous forms encountered today in the three major divisions of eukaryotic algae: Rhodophyta, Chlorophyta and Phaeophyta.

Evolution of the vegetative thallus

If the increase in morphological complexity from flagellate unicellular, through coccoid, filamentous and pseudoparenchymatous states to large parenchymatous forms such as *Macrocystis* is an evolutionary progression, the problem remains of what has caused and directed this progression.

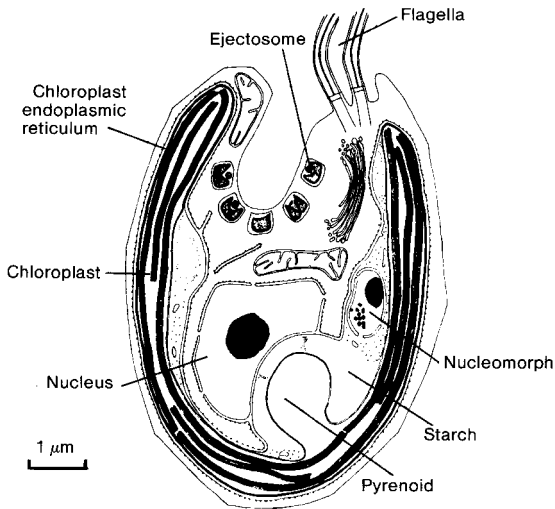

Figure 4.27 *Cryptomonas*. Longitudinal section based on electron micrographs, partly diagrammatic. (After Gibbs, from Bold and Wynne. 1985. *Introduction to the Algae*, 2nd edn. Prentice-Hall, Englewood Cliffs, NJ.)

The cause presumably lies in the mutability characteristic of all life, and the direction is no doubt a consequence of natural selection. The nature of selection in an aquatic environment, with its uniformity in space and time, is, however, little understood. This is particularly true of the marine environment, and of planktonic algae. Consequently discussion of algal evolution involves considerable conjecture.

Nevertheless, reasoned speculation is not to be discouraged, and algae undoubtedly show many features of evolutionary significance which merit consideration. Amongst the flagellate forms, for example, it is striking that the development of motile colonies and aggregate organisms has not proceeded beyond *Volvox*. Presumably, with a diameter exceeding about 1 mm (0.04 in.) the *Volvox* system would become physically unstable, and the coordination of the flagellar activity necessary to bring about directed motion of the organism no longer possible. If the earliest forms were indeed flagellate, the evolution of a sedentary form from a motile one would result in the energy that would otherwise be expended in swimming becoming available for growth and reproduction. The enhanced reproductive capacity would result in proportionately greater numbers, and provide the opportu-

nity for the establishment of a line of sedentary organisms.

The tendency for daughter cells to remain united appears to be a basic one, and would account for the occurrence of some kind of colonial or multicellular forms in all the divisions of the algae. In the major divisions we must assume that the advantages of association, possibly again residing in metabolic and reproductive efficiency, led to the elaboration of multicellular thalli in which there gradually appeared divisions of labor amongst the cells. In a multicellular form such as *Ulva*, all the cells, except possibly the basal anchor, divide and liberate reproductive bodies simultaneously. There is no somatic tissue, and the individual is destroyed in reproduction. A form in which the parent persists through several reproductive phases clearly has an advantage in a situation (as might arise with prolonged turbulence) where conditions become temporarily intolerable for the reproductive bodies, but remain tolerable for the mature plant.

The evolution of complex thalli in which reproduction was confined to special areas or branch systems would thus be favored. The further opportunity would then arise for various parts of the somatic tissue to become specialized, and assist either in the support or protection of the reproductive structures, as in the Florideophycidae and many other algae, or in the exploitation of particular habitats, as with the air bladders of many Fucales. Nevertheless the extent to which the algal thallus can diversify is clearly limited by its anatomical simplicity. This, and the uniformity of the aquatic environment, can be held responsible for the similar forms which have evolved in the different divisions (e.g., *Ulva* (p. 53), *Punctaria* (p. 86) and *Porphyra* (p. 31)). Parallelisms in reproductive regions are also notable (e.g., the trichogyne of the oogonia in the Coleochaetales (p. 64) and Florideophycidae (p. 34)).

Evolution of sexual reproduction

With regard to sexual reproduction, it seems beyond doubt that oogamy has evolved from isogamy. With forms inhabiting moving water, isogamous reproduction must be extremely wasteful, and there are evident advantages if one gamete (which becomes known as the egg cell,

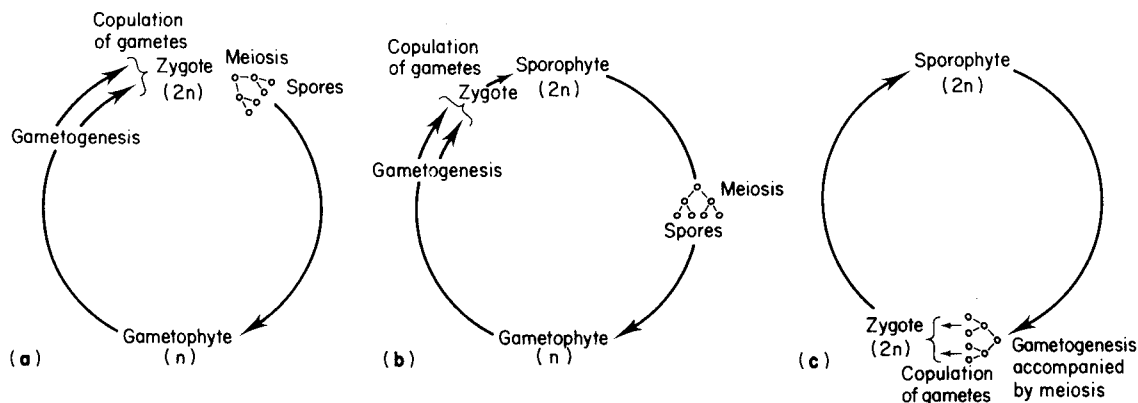

Figure 4.28 The three kinds of life cycle found in the algae.
(a) Haplontic. (b) Diplohaplontic. (c) Diplontic.

and regarded as female) remains relatively stationary, especially if it secretes pheromones causing the male gametes to accumulate around it. Moreover, a zygote which begins life with a copious food reserve has a better chance of survival than one with little. Increasing size, however, severely limits mobility, so again advantages can be envisaged in a situation in which one gamete, the male, remains small and motile, and the other, the female, loses motility and specializes in the laying down of food reserves.

A non-motile zygote may, of course, be disadvantageous if it settles in a situation unfavorable for the plant. This is compensated for in those algae, such as *Coleochaete*, in which the zygote germinates to produce zoospores. Another development, possibly limiting the wastage of zygotes, is shown in *Laminaria*, where the zygote germinates while still attached to the gametophyte, foreshadowing a feature of the archegoniate plants.

Life histories of algae

Sexual reproduction inevitably involves a cyclic alternation between a haploid and a diploid condition. The simplest life cycle found amongst the algae is that in which the diploid condition, generated by the fusion of morphologically identical gametes, is represented only by the zygote (Fig. 4.28a). Meiosis occurs on germination of the zygote, thereby initiating a new haploid (gametophytic) phase. A cycle of this kind, termed "haplontic", is frequently encountered in the simpler algae, and is typical of the filamentous

Chlorophyta. Here, however, it may have been retained and developed as an adaptation facilitating survival in unfavorable conditions, since only rarely does meiosis immediately follow syngamy, and the intervening diploid phase is often spent as a thick-walled, resting zygote.

Closely related to the haplontic cycle, and possibly evolved from it by a delaying of meiosis, is that in which the zygote generates a multicellular, diploid (sporophytic) phase. This eventually produces reproductive bodies, almost always zoospores, by a process involving meiosis. The haploid condition is thus restored and the cycle recommences (Fig. 4.28b). Where, as in *Ulva*, the haploid and diploid plants are morphologically similar, the alternation of phases is isomorphic. Where the phases are morphologically different, as, to take an extreme example, in *Cutleria*, the cycle is heteromorphic (see p. 86). The evidence available does not warrant any general conclusion about whether isomorphic life cycles have evolved from heteromorphic, or the converse. Life cycles in which both haploid and diploid phases are present as multicellular individuals are termed "diplohaplontic".

Both haplontic and diplohaplontic cycles show, in addition to isogamy, various states of anisogamy and oogamy. The complexities of the diplohaplontic cycles of the Florideophycidae of the Rhodophyta are unique amongst the algae. The early appearance of the coralline rhodophytes in the fossil record suggests nevertheless that these complexities had been acquired by Paleozoic times.

A third kind of life cycle, similar to that of most animals, occurs in the diatoms, Fucales, and

in several other isolated instances throughout the algae. The diploid condition predominates, and the haploid is represented only by the gametes, meiosis occurring during gametogenesis (Fig. 4.28c). Again the evidence does not allow any general conclusion about how this kind of cycle, termed "diplontic", originated. As with the haplontic, it may in certain instances have selective value. In *Fucus*, for example, as compared with *Laminaria*, it is perhaps an advantage to have the gametophytic phase, possibly vulnerable to the vicissitudes of intertidal life, reduced to the unicellular sporangia and gametes. A noteworthy difference between the haplontic and diplontic cycles is that in the former the gametes from one individual are genetically uniform (apart from chance mutations), whereas in the latter they are heterogeneous, depending upon the heterozygosity of the parent and the amount of crossing-over at meiosis.

Throughout the algae variations of the regular cycle have been observed both *in vivo* and *in vitro*. Gametes, for example, may occasionally develop apogamously into sporophyte-like plants without fertilization. The converse (apospory), the development of gametophyte-like plants from zygotes (e.g., *Oedogonium*, p. 51) or fragments of sporophytic tissue (e.g., *Laminaria*, p. 89), although induced in experimental conditions, has not been observed in nature, but may nevertheless occasionally occur.

Despite these observations, the existence of exclusively apogamous cycles in algae corresponding to those in tracheophytes (pp. 209, 300)

has not been fully established. The firmest indications come from the centric diatoms, where in some species there is frequent formation of auxospores (normally developing from zygotes (p. 82)) without evident male participation. Reproduction here may take the form of a regular parthenogenetic cycle.

Importance of the algae in the evolution of plants

Thus in the algae, the simplest of phototrophic organisms, a number of progressions, which can be regarded as representing channels of evolution, can be traced from unicellular to parenchymatous organization, from isogamy to oogamy, and from simple to elaborate life cycles. These all represent steps of fundamental importance in the evolution of plant life, and this fully justifies giving the algae considerable attention in any review of the plant kingdom. At its upper limit, the structural and reproductive complexity of an alga approaches that of a land plant. *Laminaria*, for example, possesses a thallus with not only morphological but also anatomical differentiation, that in the stipe being accompanied by a phloem-like function (p. 89). Additionally, the life cycle is strikingly heteromorphic, and the sporophyte is attached in the early stages of its development to the gametophyte. Considered solely in terms of the level of organization, the transition from an advanced alga such as *Laminaria* to an archegoniate or even angiospermous land plant is small when compared with the evolution of that alga from a unicellular flagellate.

The subkingdom Embryophyta: division Bryophyta (mosses and liverworts)

General features of the bryophytes

The mosses and liverworts, although morphologically somewhat dissimilar, are classified together as the Bryophyta. Because of their distinctive features they are treated as a division of the plant kingdom, of a rank equal to that of the algal groups and the Tracheophyta (Table 1.2). There are about 25000 species of bryophytes in all. Three classes are recognized, namely Marchantiopsida, Anthocerotopsida and Bryopsida. They represent the simplest of the archegoniate plants and form a single division with the following characteristics:

BRYOPHYTA

Habitat Mainly terrestrial.

Plastid pigments Chlorophylls *a*, *b*; β -carotene; xanthophyll (lutein).

Food reserves Starch, to a lesser extent fats and oils.

Cell wall components Cellulose, hemicelluloses.

Reproduction Heteromorphic life cycle, the gametophytic phase normally the more conspicuous, and the sporophytic determinate and partly dependent upon it. Sex organs with a jacket of sterile cells, the egg cells enclosed singly in flask-shaped archegonia. Zooidogamous, spermatozoids with two whiplash flagella. Embryogeny exoscopic. Sporophyte producing non-motile, cutinized spores, in some species with heavily thick-

ened and sculptured walls, usually all of one size (homospory). Vegetative propagation of the gametophyte by fragmentation or specialized gemmae.

Growth forms of gametophyte Thallus flattened, with some internal gametophyte differentiation, or consisting of a main axis with leafy appendages.

Although the simplest terrestrial plants, the bryophytes in some parts of the world form a conspicuous component of the vegetation. They are, for example, prominent amongst the epiphytes of mist forests of tropical mountains. Some species form dense communities submerged in antarctic lakes. Vast bogs in the northern hemisphere have been built up largely by the growth of the moss *Sphagnum*. The dead stems and leaves accumulate below the growing surface, decaying only very slowly in the almost anaerobic conditions in the swampy bog, and become consolidated to form peat, often several meters in depth. In some places peat is an important fuel, and in granulated form is widely used in horticulture as a source of humus.

The largest bryophyte, *Dawsonia*, is a tufted moss of swampy places in Southeast Asia and Australasia. Individual stems of this genus may reach or even exceed 1 m (39 in.) in length, but dimensions of this order are quite atypical of bryophytes. Most are lowly plants, many of them inconspicuous and not easily seen without a hand lens. The cellular differentiation within the larger bryophytes is greater than in the algae, but lacks

the complexity found in vascular plants. Amongst the mosses it reaches its maximum in *Polytrichum* and *Dawsonia*, and amongst the liverworts in *Hymenophyllum* and *Symphogyna*. In all these forms groups of elongated cells occur in the central region of the stem. Both water-conducting cells and “food”-conducting cells (analogous to sieve tubes) can be recognized in some species of bryophytes (pp. 105, 122). Some water-conducting cells approach in form the tracheids of tracheophytes, but lignification is absent.

Although a cuticle has been demonstrated in some bryophytes, in general they are little able to resist desiccation and are consequently found principally in damp and humid localities. In some species the response to humidity is remarkably precise. The moss *Pterobryella papuensis*, for example, found in the montane forest in New Guinea, forms a girdle around tree trunks about 1 m (39 in.) from the ground, where the humidity is neither too high nor too low. Other epiphytes, however, such as species of the liverwort *Metzgeria* and of the moss *Orthotrichum*, tolerate exposure and are able, by virtue of colloids present in the cell sap, to retain sufficient water to maintain life even in prolonged dryness. Electron microscopic investigations have shown that the intracellular membranes of these forms retain their basic structure even in conditions of extreme desiccation.

The morphology of the bryophytes is on the whole more complex than that of the algae. In the mosses, for example, the mature thallus regularly takes the form of a stem bearing leaves. On the other hand, the immature gametophyte (*protoneura*) of many mosses closely resembles a heterotrichous green alga and may, as for example in the moss *Pogonatum aloides*, persist for many months. Like the algae, the bryophytes produce no roots, although both the mature and immature forms of the thallus bear rhizoids. In a few forms, such as the thallose liverworts *Hymenophyllum* and *Symphogyna* and the moss *Polytrichum*, the aerial parts of the plant are continuous with subterranean creeping axes, superficially resembling the filiform rhizomes of the smaller filmy ferns. Some leafy liverworts also produce fine underground axes. These may descend to depths of 1 m (39 in.) or more in a peaty substratum and provide a means

of vegetative propagation if the site is disturbed. So far as is known, only one bryophyte (*Cryptothallus mirabilis*, a thallose liverwort) is wholly subterranean in habit and heterotrophic. The thallus lacks chlorophyll and incorporates a mycorrhizal fungus. *Cryptothallus* provides the only instance known of the occurrence of leucoplasts in the somatic cells of a liverwort. Some mosses (e.g., *Buxbaumia aphylla*) have few chloroplasts and, since they occur on rotting organic matter, are probably partly saprophytic. The regular association of certain mosses and liverworts, particularly those of swampy habitats, with specific fungi and bacteria may be indicative of synergistic relationships.

Of the two phases in the bryophyte life cycle, the haploid gametophyte is usually persistent and the sporophyte (*sporogonium*) of limited life span. The sporophyte consists of little more than a capsule, a stalk (*seta*), and a basal foot inserted into the gametophyte. The developing sporophyte is wholly or partly parasitic upon the gametophyte, drawing its sustenance by way of the foot. The apposed walls of the gametophytic and sporophytic cells at the insertion of the foot are frequently labyrinthine, either on both sides of the boundary or only on one side. In *Polytrichum*, for example, the labyrinthine walls are confined to the sporophytic face. The passage of materials into the sporophyte is entirely through the apoplast, since in all archegoniates the boundary between the two phases lacks plasmodesmata. In *Polytrichum* the transmembrane potential of the cells of the sporophytic face has been estimated to be of the order of -200 mV. This would promote, for example, the uptake of amino acids secreted into the apoplast from the gametophyte. In other respects, the labyrinthine walls, with their charged hydrated polysaccharides, may act as a filter restricting the apoplastic transfer of informational molecules. This would ensure the continued separation of the two phases and the maintenance of their distinctive developments. The formation of the labyrinthine walls probably arises from an interaction of the gametophytic and sporophytic systems (analogous to an antigen-antibody reaction), resulting, as in the defense reactions of plant pathology, in the laying down of mucilaginous polysaccharides at the

interface. Since this deposition occurs in conditions of active flux from gametophyte to sporophyte, the mucilaginous material is thrown into channels and folds. Labyrinthine walls are commonly found at sites of invasion, such as bacterial nodules in roots and mycorrhizal interfaces, where similar conditions probably obtain.

Sexual reproduction of the bryophytes is zooidogamous, and all depend upon free water for fertilization. The spermatozoids are helical in form (Fig. 5.7), although in many bryophytes the helix barely reaches or only slightly exceeds a single gyre. The helix, viewed from the anterior, is left-handed (sinistral). Most of the helix is occupied by the nucleus, with the flagella attached apically. The stability of the helix depends upon a ribbon of microtubules (spline), which runs (with diminishing width) from the apex of the gamete into the posterior, accompanying the elongated nucleus. This recalls a form of structure already seen in the algae (Fig. 3.39). The lengths of the extended helices of the spermatozoids of a selection of bryophytes range from 9.4 to 99 μm , and the DNA content of the nuclei from 0.17 to 4.05 pg (1 pg = 10^{-12} g), these two values being closely correlated. Electron microscopy gives indications of the chromatin becoming longitudinally aligned during differentiation of the sperm nucleus, but it is not known how the chromosomes are accommodated in the mature organelle. In the moss *Polytrichum* it has been reported that the chromosomes begin to adopt an end-to-end association at telophase of the last mitosis before formation of the spermatocyte. Little is yet known about the effects of polyploidy on spermatozoid size, differentiation and behavior, but laboratory and field observations do not indicate that there is necessarily any impairment of function.

The mobility of the male gametes in natural conditions is very limited, rarely more than a few centimeters, and often restricted to a few millimeters, although on a flat surface greater distances may be achieved. This inevitably limits the spread of genetic variation within a population. About two-thirds of all liverworts, and slightly more than one-half of all mosses, are dioecious. Not surprisingly, fruiting is more frequent amongst monoecious bryophytes than dioecious.

Although reproduction in monoecious bryo-

phytes is presumably dependent largely on selfing (particularly in the case of synoicous mosses, in which the antheridia and archegonia occur together), there is no evidence that this has deleterious consequences in nature. Self-incompatibility has been detected in laboratory cultures of mosses, but its occurrence in the wild is conjectural. Investigators have remarked upon the frequent finding of apparently healthy antheridia which either failed to open or yielded non-motile spermatozoids. There may be unidentified environmental factors causing deficiencies of this kind. They would inevitably limit the fertility of natural populations.

Dispersal of bryophytes depends upon the spores, produced meiotically by the sporophyte. These are mostly light and readily wind-borne. They contain chloroplasts and are surrounded by a two-layered wall, an inner *intine* and an outer *exine*. Sporopollenin, often deposited in a pattern characteristic of the species, is a feature of the exine. This complex polymer protects the spores from rapid dehydration. Although some of the sporopollenin is produced by the spore itself, much also comes from degenerating cells adjacent to the sporocytes. This is added to the exine in the final stages of differentiation. These degenerating cells do not, however, form a distinct tissue with a clear function as in most tracheophytes.

Many bryophytes produce capsules only rarely or (so far as known) not at all. About 40 percent of the British moss flora produces sporophytes only very occasionally, and 18 percent of the British and 9 percent of the eastern North American moss floras have been found only as gametophytes. These species evidently rely largely or exclusively on asexual means of reproduction.

The features used in the classification of the bryophytes are first the nature of the thallus, and (where present) of the leaves, secondly the extent of the development of the juvenile phase of the gametophyte, and thirdly the presence or absence of an opening mechanism in the capsule.

Marchantiopsida (liverworts)

Despite the diversity of the liverworts, there is little doubt that they form a natural group. The protonemal phase of the gametophyte is usually

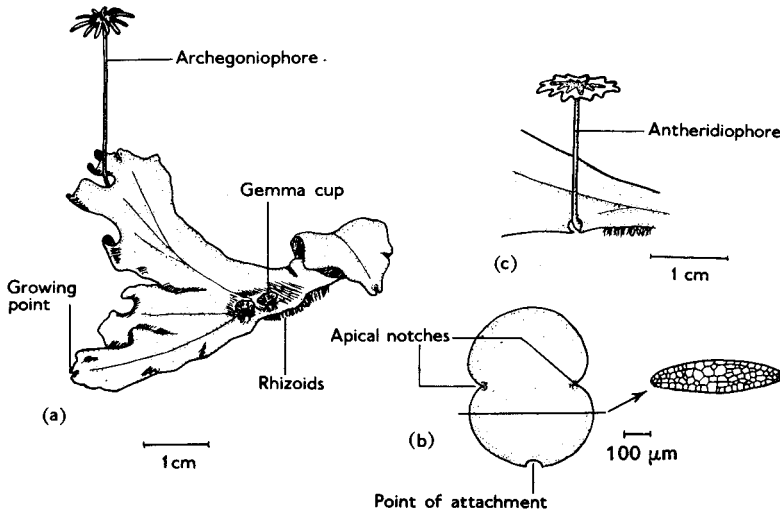

Figure 5.1 *Marchantia polymorpha*.
 (a) Habit of female plant. (b) Structure of gemma. (c) Antheridiophore.

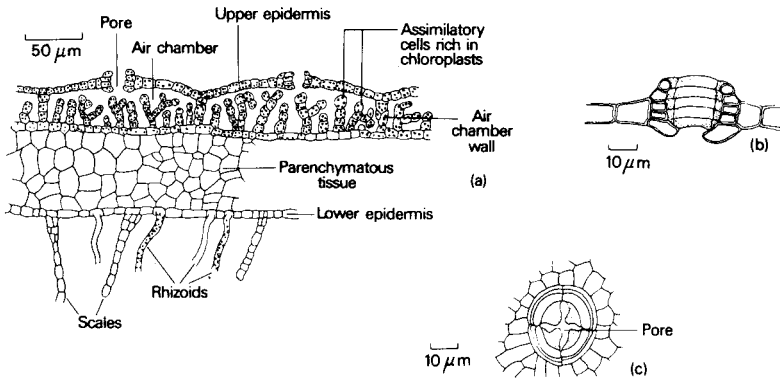

Figure 5.2 *Marchantia polymorpha*.
 (a) Transverse section of thallus. (b) Transverse section of pore. (c) Surface view of pore.

ill defined and the mature thallus almost always shows recognizable dorsiventrality. A characteristic feature of many liverworts is the presence of oil bodies, often of complex morphology, in the cytoplasm. These possibly render the tissues unpalatable to grazing insects. Liverworts also produce bacteriocidal substances, and some of these may have commercial value.

The antheridia of liverworts break open irregularly, instead of by a distinct cap cell. The capsule of the sporophyte matures before the elongation of its stalk, the converse of the situation in the mosses.

Of the seven orders of the Marchantiopsida, the common Marchantiales, Jungermanniales and Metzgeriales will be considered in some detail, and the small orders Sphaerocarpaceles and Calobryales mentioned on account of special features which claim attention.

The Marchantiales

The Marchantiales are exclusively thalloid. Although some species are simple in appearance and structure, internal organization more complex than that found in any other thalloid liverworts is also encountered in this order.

The thallus of *Marchantia* itself (Fig. 5.1), frequent on damp soil and areas of burnt ground, is dichotomously branched, with a thickened central rib and the surface divided into hexagonal areas visible with the naked eye. On examination with a hand lens, a pore can be observed at the center of each hexagonal area, which in transverse section is seen to consist of an air chamber containing photosynthetic tissue (Fig. 5.2). The pore, like the stoma of a higher plant, probably allows aeration of the thallus with the minimum dehydration, although it is incapable of significant change in its aperture. Below the chlorophyllous

tissue is a compact body of cells largely lacking chloroplasts. The lower side of the thallus bears up to eight rows of scales and unicellular rhizoids, the walls of some of which bear peg-like invaginations (“peg rhizoids”). The growth of the thallus is sensitive to photoperiod, and ceases in long days. This is accompanied by an accumulation of lunularic acid, an endogenous growth regulator, possibly found in liverworts generally.

Amongst other members of the Marchantiales showing a chambered thallus are *Conocephalum*, the thallus of which yields a characteristic fragrance when crushed, and *Preissia*. In *Conocephalum* the pore is much simpler than in *Marchantia*, but in *Preissia* the pore is not only complex but its aperture also diminishes with falling humidity. This feature may help to limit loss of water from the chamber and account for *Preissia* being able to tolerate drier habitats than *Marchantia*. The midrib of the thallus of *Preissia* also contains conspicuous elongated fibrous cells. In *Conocephalum* elongated water-conducting cells in the ventral parenchyma have thickened walls furnished with circular thin-walled pits. Plasmodesmata are frequent in the primary pit fields. Anastomosing bands of cellulosic material decorate the inner surface of the wall. The marchantialean liverwort *Asterella* also displays elongated cells in the central part of the midrib. These have thick walls, and the cytoplasm, aggregated at the apical end of the cell, contains an assemblage of small vacuoles and microtubules. Numerous plasmodesmata with conspicuous desmotubules are found in the end walls. These cells seem more likely to be concerned with the conduction of food materials than water. *Exormothea* of South Africa, also marchantialean, is extremely xerophytic. It forms colonies on decaying granite or gneiss, and can withstand at least eight months of absolute dryness. The cells contain proteins with immunological properties similar to those of the dehydrins found in blue-green algae and higher plants subject to periodic desiccation.

Riccia represents the simplest kind of structure found in the order. The lower part of the thallus is again a compact colorless tissue, but the upper part consists of columns of chlorophyllous cells, separated by narrow air channels. The upper cells of the columns are colorless and fit closely

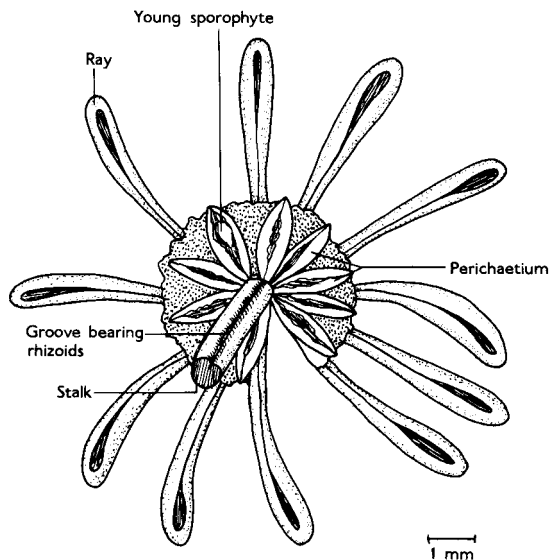

Figure 5.3 *Marchantia polymorpha*. Archegoniophore seen from below.

together, leaving no distinguishable pores. In *Riccia fluitans* (Fig. 5.9) the narrow, dichotomously branched, floating thallus is divided almost entirely into air chambers separated by partitions one cell thick.

REPRODUCTION

In *Marchantia*, which is dioecious, sexual reproduction is induced by increasing day length. The male and female gametes are produced on upright, umbrella-shaped structures termed *antheridiophores* and *archegoniophores* respectively (and *gametangiophores* collectively) (Fig. 5.1a and c). Both structures develop from one half of a dichotomy and are therefore homologous with a bifurcation of the thallus. Their morphological nature is clearly demonstrated by the rhizoids which grow down grooves in the stalks (Figs. 5.3 and 5.4) and by the characteristic photosynthetic chambers which develop in the caps of the mature gametangiophores. The female organs (archegonia) arise in radial rows on the upper surface of the cap. During the maturation of the archegonia, the cap grows more above than below, with the result that the archegonia become transferred to the lower surface. In the mature archegoniophore (Fig. 5.5) each row of archegonia is separated from its neighbors by a curtain-like outgrowth, termed a

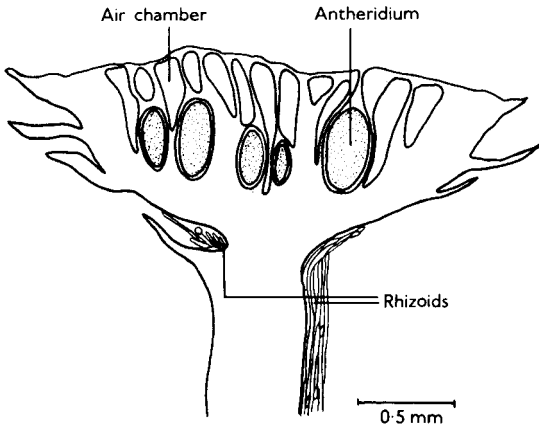

Figure 5.4 *Marchantia polymorpha*. Vertical section of antheridiophore.

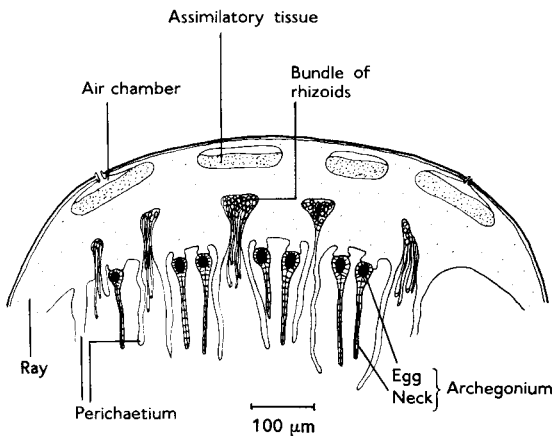

Figure 5.5 *Marchantia polymorpha*. Tangential section of an almost mature archegoniophore.

perichaetium. In addition, sterile processes emerge radially from the upper surface of the cap between the rows of archegonia, giving the whole its familiar stellate appearance (Fig. 5.3).

The archegonium, as always in the bryophytes, is formed in its upper parts by a simple column of cells, and has a strikingly long neck (Fig. 5.6). The egg lies at the dilated base of the ventral canal and, when mature, appears to be suspended in fluid. It is surmounted by a ventral canal cell, and a number of neck canal cells. These degenerate at maturity, and their products, when hydrated, give rise to a mucilage through which the spermatozooids swim to reach the egg.

The antheridiophore lacks the complexity of the archegoniophore, being merely an elevated cap (Fig. 5.4), with the antheridia on the upper surface. Although superficial in origin, the mature antheridia are sunk in pits, each opening to the exterior by a narrow pore. Each antheridium is borne on a short stalk and bounded by a single layer of sterile jacket cells. When mature it contains a mass of small cubical cells (spermatocytes or antherocytes) in each of which differentiates a biflagellate spermatozoid. This is in the form of a single gyre of a helix and consists of a headpiece, an elongated nucleus, and a cytoplasmic tail (Fig. 5.7). The headpiece includes the two posteriorly directed flagella, one inserted behind the other, and a large mitochondrion. Close to this is a lamellate body, the multilayered structure. A ribbon of microtubules, lying at an angle of 45° to the plates of the MLS, extends from the surface of this body and follows a helical path along the outside of the nucleus. The tail contains a large plastid, parts of which extend as a flap over the end of the nucleus, and a mitochondrion lying in a depression in the plastid. The differentiation of these highly specialized gametes from cells which are initially more or less isodiametric presents many problems of gene activation and cell mechanics. Particularly interesting is the state of the chromatin. Coarse fibrils becoming oriented parallel to the longitudinal axis of the nucleus are evident in the early stages of the differentiation of the nucleus, but the chromatin is fully condensed in the mature gamete.

The mature antheridia open in moist conditions and the spermatocytes, in contact with a film of water, are rapidly dispersed, possibly a consequence of the high surface tension of the cell membrane. After a short time the spermatocytes themselves break open and release the spermatozooids. For fertilization to be possible the male and female plants must be growing together. It seems likely that the gametangia become mature, and fertilization occurs, before elongation of the gametangiophores.

Although detailed observations are few, germination of the zygote of *Marchantia* probably begins within 48 hours of fertilization. The first division is by a horizontal wall, transverse to the longitudinal axis of the archegonium. Since it is from the

Figure 5.6 *Marchantia polymorpha*.

(a) Archegonium before breakdown of neck canal cells. (b) Mature archegonium.

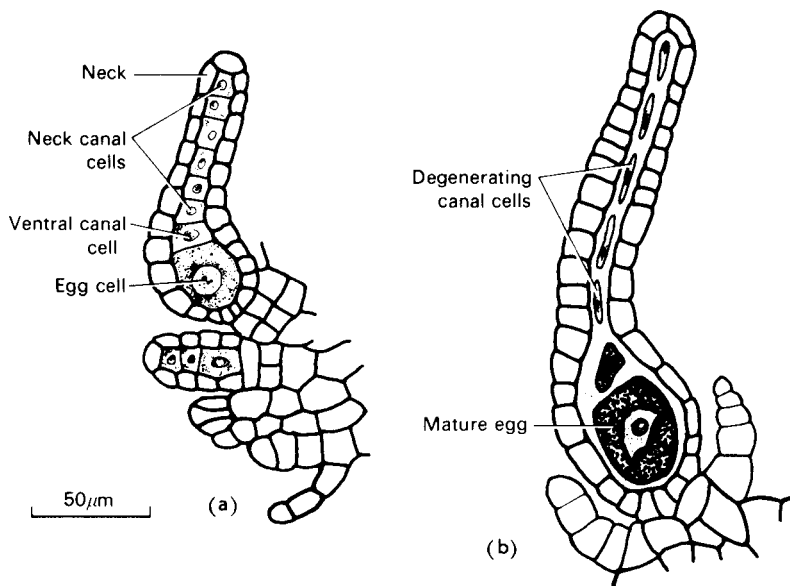
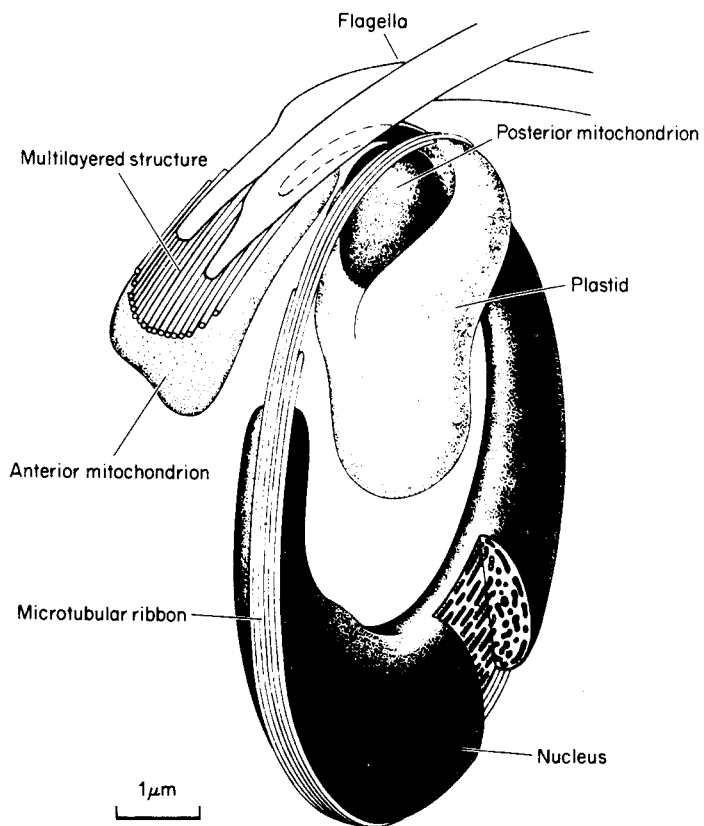

Figure 5.7 *Marchantia polymorpha*.

Diagram showing the disposition of the organelles in an almost fully differentiated spermatozoid. The nucleus is cut open to show the condensing chromatin. Scale approximate. (After Carothers. 1975. *Biological Journal of the Linnean Society* 7, Supplement 1.)



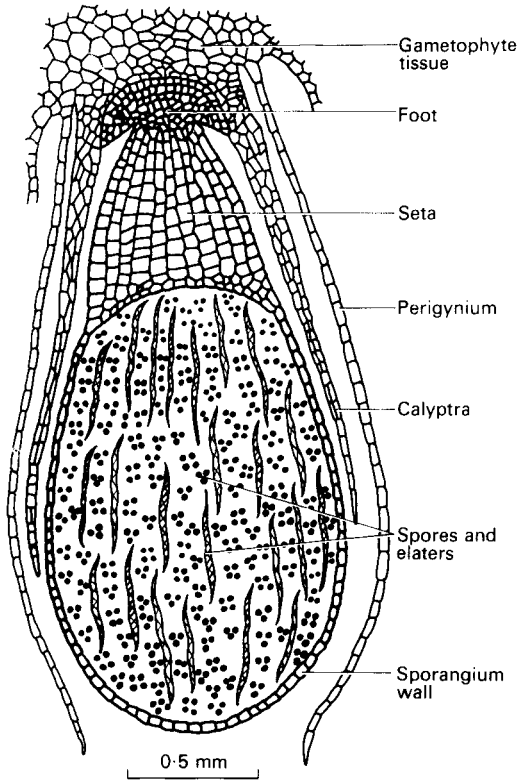

Figure 5.8 *Marchantia polymorpha*. Longitudinal section of sporophyte rupturing the calyptra. Note the parallel alignment of the elaters. (After Parihar. 1967. *Bryophyta*. Central Book Depot, Allahabad.)

outer cell that the apex of the sporophyte arises, embryogenesis is said to be “exoscopic”. The products of the inner cell form the foot, by which the sporophyte remains anchored in the gametophyte. Continued growth and differentiation, which are dependent upon nutrients drawn from the gametophyte, lead to an embryonic sporophyte consisting of three distinct regions. At the summit is the immature capsule containing the sporogenous cells, below this is a short seta, and, at the base of the seta, the foot (Fig. 5.8).

At this stage, the young sporophyte is not only enclosed by the proliferated jacket cells of the archegonium, which form a *calyptra*, but also surrounded by a further tubular outgrowth of the gametophyte called a *pseudoperianth* (or *perigynium*). Division of the sporogenous tissue (*archesporium*) inside the capsule remains mitotic until eventually the spore mother cells (*sporocytes*) are

formed. In these the nucleus undergoes meiosis. The protoplast, without initial furrowing, is divided into four spores, each with a haploid nucleus. The spores of the tetrads separate in the capsule, become rounded in outline, and develop walls. Not all the cells inside the capsule become sporocytes; some (referred to as *elaters* because of their subsequent behavior) elongate and lay down spiral thickenings.

Elongation of the cells of the seta eventually causes the calyptra to rupture, and, once exposed to air, the single layer of cells surrounding the capsule soon bursts, so revealing the mass of yellow, haploid, spores. The loosening of this mass and the dispersal of the spores are now assisted by the contortions of the elaters. These contortions are caused by the spiral bands in their walls, presumably consisting of cellulose microfibrils, altering their curvature and pitch as they dry. In response to the strains generated in this way, the cell as a whole makes jerky twisting movements.

The spores germinate rapidly on a damp surface, giving rise to short, alga-like filaments of cells. Division of the apical cell then ceases to be confined to one plane and subsequent growth leads to the mature form of the gametophyte.

In most capsules of *Marchantia* a number of dyads can usually be found in addition to tetrads. The spores of the dyads are larger and contain an unreduced chromosome number. They yield diploid gametophytes. In *Marchantia polymorpha* these are either purely male or purely female, but in some tropical species bisexual diploid forms are known.

No other genus has gametangiophores as elaborate as those of *Marchantia*. In *Conocephalum*, for example, the archegoniophore is a simple cap without emergent rays, but its surface has complex pores in contrast to the simple ones elsewhere. In *Riccia*, gametangiophores are entirely absent, both archegonia and antheridia merely lying at maturity in pits in the dorsal surface of the thallus. The sporophyte generation is again dependent on the gametophyte for nutrition, but at maturity it consists of only a sac of spores, with no seta or foot (Fig. 5.9). By the time the spores are mature no living diploid tissue remains, and dispersal must await the decay of the gametophyte. In some species of *Riccia* the spores continue to

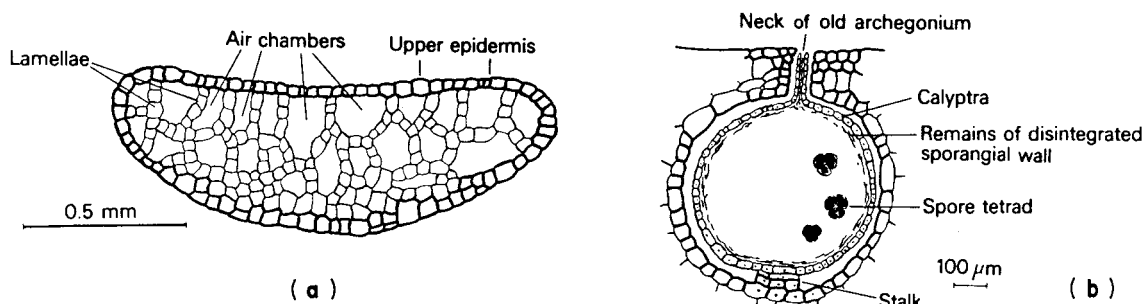

Figure 5.9 *Riccia fluitans*. (a) Transverse section of thallus. (b) Thallus containing mature sporophyte.

cohere in their original tetrads. In *Conocephalum japonicum* the sporocytes are cylindrical and the orientation of the spindles at meiosis is restricted. In consequence the tetrad of spores is linear and not tetrahedral.

Asexual reproduction of the Marchantiales often follows from bifurcation of the thallus being accompanied by progressive decay of the older posterior region. In this way, an area becomes quite rapidly colonized by many seemingly individual plants. Additional to this, *Marchantia* has a notably elegant means of asexual reproduction. Multicellular bodies, called gemmae, develop inside cup-like growths on the upper surface of the thallus (Fig. 5.1a). Each gemma is slightly biconvex, with two diametrically opposed, marginal notches, each containing a small meristem (Fig. 5.1b). When mature, the gemmae become detached from the short stalk on which they are borne, and are readily dispersed. Experiments have shown that the newly detached gemmae have no innate dorsiventral symmetry. This becomes fixed at germination by gradients of light, temperature and other factors in the immediate environment. Each meristem grows out to form a new thallus and, finally, two individuals result from decay of the central portion.

Culture experiments have shown that short days promote the production of gemmae. The germination of the gemmae while in the cup is inhibited by growth-regulating substances diffusing basipetally from the apical meristem of the parent thallus.

EVOLUTION

Marchantia seems to represent the highest level of organization achieved by a wholly thalloid gametophyte. Are we therefore to regard the simple *Riccia* as a primitive marchantialean plant, and *Marchantia* as an advanced form? Although this would appear plausible, some striking breeding experiments with *Marchantia* point in the other direction. A number of mutants were raised from species of *Marchantia* in culture and hybridized in various ways, with the result that a whole series of forms was obtained which reproduced features found in other genera of the order. The thallus of the var. *dumortieroides*, for example, lacks air chambers and resembles that of *Dumortiera*, a genus which, except for this feature, is close to *Marchantia*. Similarly the var. *riccioides* resembles *Riccia* in its narrow branching and the immersion of sex organs in the prostrate thallus. This reservoir of variation in *Marchantia* suggests that its evolutionary antecedents may have yielded the other genera of the order by a process of simplification. *Riccia* would then be regarded as a reduced form.

On the other hand, perhaps both *Marchantia* and *Riccia* should be regarded as evolved forms. The archegoniophores of *Marchantia*, which elevate the almost seta-less capsule and facilitate the wide dispersal of the relatively thin-walled spores in air currents, can reasonably be regarded as an advantageous development. In the xerophytic species of *Riccia*, however, the spores are thick-walled and long-lived. Despite the apparent rudimentary sporophyte, these species of *Riccia* are probably no less well adapted than *Marchantia*, but to a different, Mediterranean environment. Nevertheless, comparative ribosomal RNA data point to *Riccia* being ancient in the Marchantiales. Clearly identifiable remains of both *Marchantia*-

and *Riccia*-like Marchantiales have been found in Upper Triassic coals of Sweden, establishing the antiquity of the marchantialean kind of thallus. Persistent tetrads of a smooth marchantialean kind (p. 109), associated with remains of a possibly *Riccia*-like thallus, of Silurian or Lower Devonian age have been reported from the Welsh Borderland. Mats of *Marchantia*- and *Riccia*-like liverworts are a prominent feature of early Cretaceous deposits in Antarctica. They appear to have colonized newly deposited river sands and muds. These mats probably had an important ecological function in binding virgin sediments and promoting further colonization by tracheophytes.

Possibly allied to the Marchantiales is the largest known thallose liverwort, *Monoclea*, of New Zealand. There are no specialized gametangio-phores, but the manner of growth is similar to that of *Marchantia*, and, as in *Marchantia*, there is no furrowing of the sporocyte protoplast preliminary to spore formation. The thallus may reach a length of 25 cm (10 in.), and its branches a width of 5 cm (2 in.).

The Jungermanniales and Metzgeriales

The Jungermanniales and Metzgeriales, the largest orders amongst the hepatics, contain both thalloid and leafy forms. Most achieve only a small size in temperate regions, but leafy forms reaching several centimeters in length are common in the humid tropics, where they are frequently epiphytic. The thalloid genera are typified by the common *Pellia*, which grows dichotomously as in *Marchantia*, but differs in outward appearance. A poorly defined midrib of elongated cells extends to each apical region. Examination under the microscope shows that the thallus is indeed simple, having none of the specialized photosynthetic tissue of the Marchantiales. Some genera have much more distinct midribs (*Pallavicinia*), while others, in which the thallus is regularly dissected (*Fossombronina*), begin to resemble the leafy forms. Morphological differentiation in the thalloid forms reaches its peak in some of the tropical representatives. In *Symphogyna*, for example, the filiform underground rhizome gives rise, in a sympodial fashion, to a sequence of erect aerial thalli. These, to which the photosynthesis is confined and on which the sex organs are borne,

may reach a height of 2 cm (0.75 in.). The rhizome contains a fine strand of elongated water-conducting cells, the differentiation of which begins closely behind the apical cell. The mature cells have several series of pits arranged helicoidally, each pit being ontogenetically related to a plasmodesma. The heterotrophic *Cryptothallus* (p. 103) is also placed with the Metzgeriales.

The leafy liverworts also show a wide range of vegetative morphology, but here principally in the form of the leaves. These may be simple, more or less circular, plates of cells, as in the common *Odontoschisma sphagni*, or more often twice or several times lobed. Sometimes the leaves achieve great delicacy. In *Blepharostoma*, for example, the lobes consist only of a single file of cells. In *Frullania*, the leaf has two lobes, the lower of which is shaped like a minute helmet, and possibly serves as a water sac.

In most leafy liverworts the stem is inclined or prostrate, and its symmetry clearly dorsiventral. Although the leaves are usually in three ranks, only those on the dorsal side are fully developed. Those of the third, ventral row (termed *amphigastria* or under leaves) remain small, and are often shed a short distance behind the apex. Surprisingly, it was found possible to cause the development of ventral leaves of normal form by treating cultures of some leafy liverworts (e.g., *Plagiochila* and *Gymnocolea*) with hydroxyproline (an amino acid) or the inhibitor 2,2'-dipyridyl (which prevents the formation of hydroxyproline from proline). These results indicated that a protein containing both proline and hydroxyproline was probably involved in modulating morphogenesis in these plants. This protein may be an arabinogalactan (AGP), a class of proteins widely distributed in plants, and known to have morphoregulatory properties (see, e.g., p. 294).

Classification of the leafy liverworts is based largely on the features of the leaves, including the orientation of their insertions on the stem. When the anterior margins of the leaves lie regularly beneath the posterior of those in front, the arrangement is said to be *succubous* (Fig. 5.10b) and when the converse *incubous*. The leaves of liverworts regularly lack nerves of the kind seen in mosses, but the lower lobes of the bilobed leaves of *Diplophyllum* possess a conspicuous central row

Figure 5.10 *Lophocolea cuspidata*.

(a) Fertile shoot seen from above.
 (b) Ventral surface showing amphigastria and the succubous arrangement of the leaves (see text).

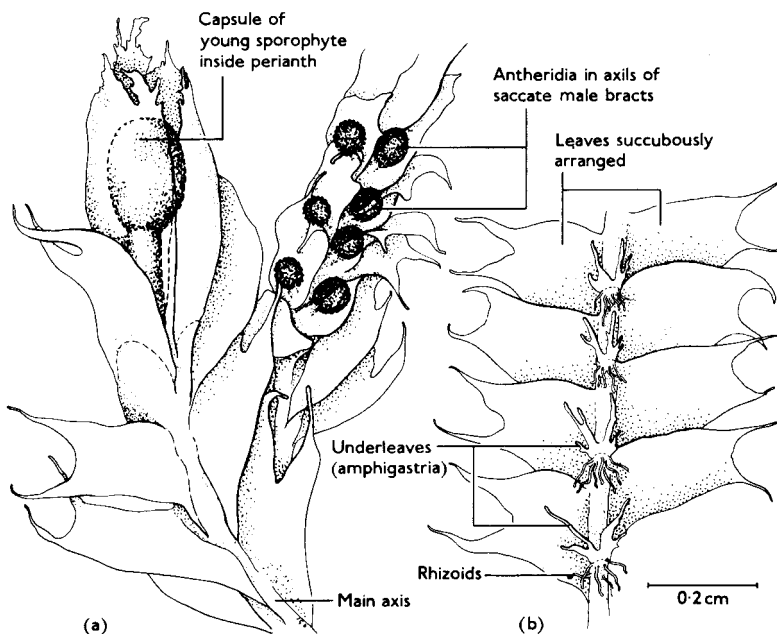

of elongated cells. Conduction of water along the stems of leafy liverworts is probably largely by surface capillarity. Experiments have shown that such transport is more rapid with succubous arrangements of leaves than with incubous.

REPRODUCTION

Sexual reproduction is essentially similar to that described for the Marchantiales, except that specialized gametangio-phores are never produced. The antheridia, superficial in origin, usually occur singly, lying either in cavities in the upper surface of the thallus (e.g., *Pellia*, Fig. 5.11) or, in leafy forms, in the axils of leaves of special branches of limited growth (Fig. 5.10a). The spermatozoids are basically similar to those of *Marchantia*, with differences in detail of the MLS and microtubular ribbon. In at least one species of *Pellia* the spermatozoids are relatively large, the nucleus extending for several gyres. Also in *Pellia* the microtubular ribbon, as seen in transverse section, is not closely applied to the nucleus across its whole width, but is inclined at an angle of about 45° to its surface. The archegonia are usually grouped, and are produced either laterally, as in *Pellia* (Fig. 5.12), or at the tip of the main shoot, as in most leafy liverworts. When archegonia are apical, they, and ultimately the sporophyte, terminate the growth of the main shoot, so that vegetative growth is continued by a lateral, resulting in sympodial branching. Both monoecious and dioecious forms occur, sometimes in the same genus. The common *Pellia epiphylla*, for example, is monoecious, but *P. fabbronia*, frequent in calcareous districts, is dioecious.

The sporophyte of the Jungermanniales and Metzgeriales (Fig. 5.13) has a higher proportion of sterile tissue than that of the Marchantiales. The

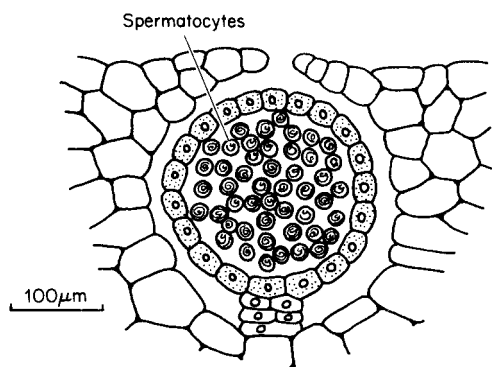
**Figure 5.11** *Pellia*. Vertical section through antheridium.

sporophytes are green when young, and capable of appreciable photosynthesis. Minerals are probably largely transmitted from the gametophyte, but some may be absorbed directly. The capsule develops while still enclosed in the calyptra and the ultimate extension of the seta, which may reach 1 cm (0.4 in.) or more, is extremely rapid (rates of $1 \text{ mm (0.04 in.) hour}^{-1}$ have been recorded in *Pellia*). This extension is brought about solely by cell elongation, and is accompanied by the disappearance of starch from the cells. Extension is markedly diminished if the activity of the Golgi

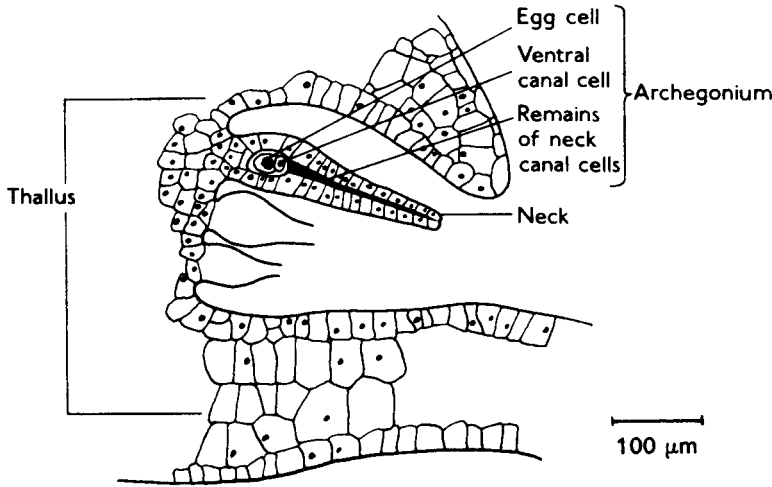

Figure 5.12 *Pellia*. Vertical section of thallus showing archegonia.

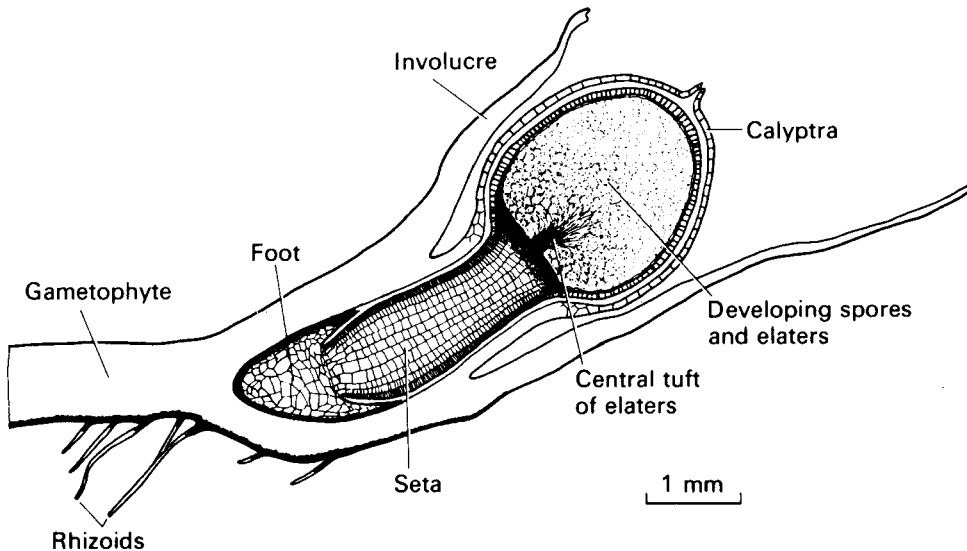

Figure 5.13 *Pellia*. Longitudinal section of maturing sporogonium.

bodies in the cells is inhibited, indicating that it is dependent upon a supply of hemicelluloses reaching the walls. The extending setae display phototropism, but the curvature is confined to the regions illuminated. There is no transmission of the stimulus, a conspicuous feature of phototropism in coleoptiles and seedlings. This difference is presumably related to the absence in the sporophyte of *Pellia* of any localized site of growth.

Meiosis in the sporocytes of the Jungermanniales and Metzgeriales is preceded by

a lobing of the protoplast, the furrows indicating the planes which will separate the four spores of the tetrad. Elaters are commonly present amongst the spores. The capsule usually opens by four valves which, as a consequence of differential thickenings in the wall, become sharply reflexed. The manner in which the elaters assist the distribution of the spores varies. In *Pellia* the elaters, some of which remain as a brush attached to the top of the seta (Fig. 5.13), are similar to those of *Marchantia*. In some genera, however, the elaters are “explosive”. In *Cephalozia bicuspidata*, for example, the elaters are loosely attached to the ends of the valves of the capsule. After the capsule opens they begin to dry and in consequence to

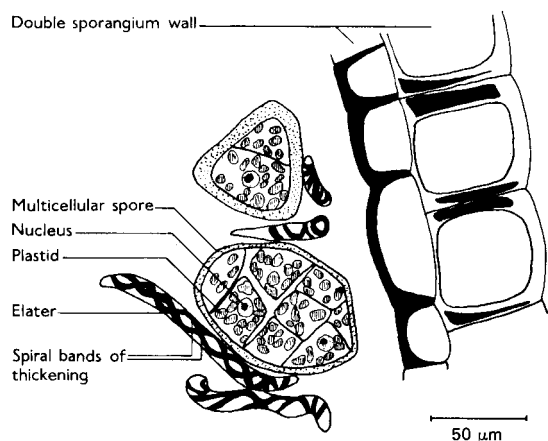

Figure 5.14 *Pellia*. Portion of capsule showing detail of the wall, multicellular spores and elaters.

twist. Suddenly they violently untwist, hurling both the elater and its adhering spores into the air. The sudden expansion of the elater is believed to be caused by the shrinking column of fluid in the drying cell being put under such tension that it eventually spontaneously vaporizes, thus increasing its volume many times.

The spores of *Pellia* begin to develop before being shed (Fig. 5.14), a feature also found in a number of epiphytic leafy liverworts. The spores of *Cryptothallus* tend to stick together in their original tetrads. Some species of the Jungermanniales and Metzgeriales are rarely fertile. Capsules of *Plagiochila tridenticulata* are wholly unknown. This may be a consequence of the two sexes having acquired different distributions. The North American populations appear to be female and the European male.

Asexual reproduction of many species takes place by regeneration from fragments of mature plants. Multicellular gemmae are not uncommon and are sometimes conspicuous, as, for example, the clusters of reddish two-celled gemmae on the margins of the upper leaves of *Sphenobolus exsectiformis*, a plant frequent on rotting wood. In *Blasia pusilla*, a thalloid form, multicellular gemmae are produced in remarkable flask-shaped receptacles on the dorsal side of the thallus. Release of the gemmae in liverworts takes place by the cleavage of a wall common to a cell of the gemma and the parent (a *schizolytic* mechanism).

Remains very suggestive of members of the

Jungermanniales and Metzgeriales are known from Devonian and Carboniferous rocks.

The Sphaerocarpaceae

The best-known member of the Sphaerocarpaceae is *Sphaerocarpos*. The thallus resembles that of the simpler Marchantiales, such as *Riccia*, but the margin is frilly and suggestive of leaves. The antheridia and archegonia occur in small clusters, each cluster enclosed in a distinctive involucreal sheath. As in *Riccia*, the sporophyte is little more than a capsule. The spores can be stored indefinitely in de-aerated distilled water. In these conditions they do not germinate, but viability is preserved. The walls of the spores are commonly heavily thickened, and the inner wall has been shown to consist of multiple separate lamellae, a feature seen in the spores of some of the earliest land plants (p. 115).

Sphaerocarpos, which is regularly dioecious, has figured prominently in genetical investigations. It was found, for example, that the wavelength of UV light most effective in producing mutations in nuclei of immature spermatozoids was that most strongly absorbed by nucleic acids, providing the first evidence for the special rôle of these acids in heredity. *Sphaerocarpos* was also the first plant in which sex chromosomes were demonstrated. The female gametophyte possesses a large X chromosome and the male a small Y, in each instance accompanied by seven autosomes. Irradiation experiments have shown that both chromosomes contain genetic information essential for the development of the respective sexual features, and, in the case of the Y chromosome, for a factor responsible for ensuring mobility of the spermatozoids.

Sphaerocarpos has also provided excellent material for Mendelian studies, since in several species the spores cohere firmly in their original tetrads. The products of each meiosis can then be separated and cultured individually, allowing a direct demonstration of genetic recombination ("tetrad analysis"). The spores are also of interest in relation to the inheritance of the pattern of thickening of the wall, a feature used to discriminate species. The spores in hybrid capsules show the thickening characteristic of the female parent, suggesting that the factors determining

the pattern are maternally inherited through the cytoplasm of the egg cell.

Although *Sphaerocarpos* is normally found on damp earth, *Riella* is submerged, some species being able to withstand brackish conditions. The thallus takes the form of an erect filiform stem, rarely exceeding 2 cm (0.75 in.) in height, bearing along one side a ruffled “wing” only one cell thick. The rhizoids are confined to the base. The fossil *Naiadita* from the Upper Triassic is strikingly similar to *Riella* (except that there is no well-developed involucre around the sex organs), and it probably grew in similar situations. Its reference to the Sphaerocarpaceae seems well established. Dyads of spores with a structure similar to that of sphaerocarpacean spores have been described from the lower Silurian, and intact tetrads with similar features from the Lower Carboniferous.

The Calobryales

The small order Calobryales, of which *Haplomitrium* is representative, is highly distinctive and the two genera it contains have a similar growth form. The upright stems, which are radially symmetrical and bear three ranks of leaves, rise from a creeping rhizome-like axis lacking rhizoids. The archegonia are effectively terminal. There are no involucre leaves protecting the young sporophyte, but the calyptra is particularly conspicuous. The spores of *Haplomitrium* show irregular cohesion in dyads and tetrads.

Some bryologists have considered the sexual reproductive structures of the Calobryales to be the most primitive amongst the bryophytes as a whole. The curious plant *Takakia* (p. 121), from Japan and the Pacific Northwest and originally thought to be allied to the Calobryales, is now known to be a moss.

Anthocerotopsida (hornworts)

This class contains a single order, Anthocerotales (hornworts). Although formerly included with Marchantiopsida, the Anthocerotales are now usually placed in a separate class, mainly on account of their unique sporophyte. *Anthoceros* is representative of its class.

The Anthocerotales

The gametophyte of *Anthoceros* recalls *Pellia* in external morphology except that there is neither regular dichotomous growth nor a midrib (Fig. 5.15a). The thallus is undifferentiated, apart from internal cavities which contain mucilage and occasionally the blue-green alga *Nostoc*, a genus known to fix atmospheric nitrogen. In most species a single chloroplast, containing a complex pyrenoid, occurs in each cell, a situation unknown elsewhere in the Bryophyta or in higher plants (with the exception of some species of *Selaginella*), but common in the algae. This has led to the suggestion that the Anthocerotae are closer to an algal ancestry than other Bryophyta. The lower surface of the thallus of most anthocerotes contains mucilage pores. The orifice of each is bounded by two cells, giving a close resemblance to simple stomata (hence the term “pseudostomata”).

Some species of *Anthoceros* (such as those of the Mediterranean region) regularly form tubers, enabling them to tide over a dry season unfavorable for growth.

REPRODUCTION

In *Anthoceros*, as in *Marchantia*, the formation of the sex organs is dependent upon photoperiod. Here, however, gametogenesis in most species is initiated by diminishing day length, so that fertilization occurs during winter.

The antheridia arise from a cell beneath the surface, one to several antheridia (depending upon species) coming to lie in a closed chamber (Fig. 5.15b). The roof remains intact until the antheridia are mature. The spermatozoids resemble those of the liverworts generally, but have some distinguishing features of ultrastructural detail.

Archegonia arise superficially, but the wall of the archegonium is continuous with the thallus, the neck opening at the surface (Fig. 5.15c). This resembles the situation in some vascular archegoniates (see, for example, Fig. 6.20b). Development of the diploid zygote leads to a slender cylindrical sporophyte (Fig. 5.16) with a relatively small proportion of fertile tissue. The sporophyte remains inserted into the gametophyte by a conspicuous lobed foot, and the basal

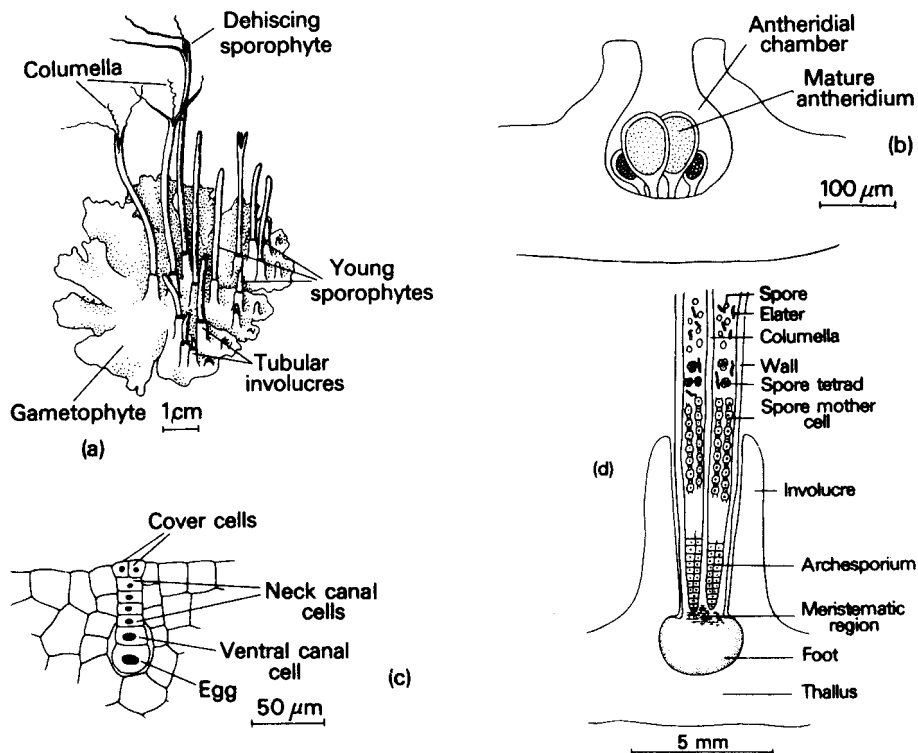

Figure 5.15 *Anthoceros laevis*. (a) Female thallus with sporophyte. (b) Section of antheridial chamber. (c) Section of nearly mature archegonium. (d) Diagrammatic longitudinal section of a sporophyte showing the different regions.

part is surrounded by an upgrowth of the thallus, the involucre.

The development of the archesporium begins as a dome-like layer within the summit of the sporophyte. The sporophyte continues to grow for several weeks or longer from a meristem close to its base. During this growth the archesporium differentiates basipetally as a hollow cylinder, the center of which is occupied by a sterile columella. Multicellular elaters (which lack distinct spiral thickenings and are often referred to as pseudo-elaters) differentiate amongst the sporogenous cells. When the spores at the top of the capsule are ripe, the capsule dehisces basipetally (Fig. 5.15a) along two longitudinal slits, the opening beginning near the tip. As the upper part of the capsule dries, the valves separate completely above, and they begin to twist longitudinally. The consequent contortions of the valves expose the spores and elaters adhering to the central column, and dis-

persal begins. The separation of the valves continues downward as the spores mature, and meanwhile the basal meristem generates new sporophytic tissue at about the same rate. Consequently a single sporophyte continues to yield spores over a considerable period. The spores have conspicuously thickened and sculptured walls.

Anthoceros and its allies further differ from other liverworts, but resemble the mosses, in possessing photosynthetic tissue in the outer layers of the extending sporophyte. Stomata are also present, as in the capsules of some mosses. The sporophyte is thus not entirely dependent on the gametophyte for nutrition, but, since the sporophyte will still mature even if it is covered with a tinfoil cap, it seems likely that it is able to draw a substantial proportion of its essential metabolites from the parent gametophyte.

EVOLUTIONARY POSITION

The Anthocerotales are remarkable amongst the liverworts in recalling the features of both the algae (the presence of the pyrenoid in the chloroplast) and the mosses and higher plants (the pres-



Figure 5.16 *Anthoceros laevis*. Female plants bearing young sporophytes. Scale bar 5 cm.

ence of stomata and the continued growth of the sporophyte). They are consequently thought by some to stand close to the line of evolution leading from the algae to terrestrial vegetation. The intermediate position of the Anthocerotales extends even to their ultrastructure. The electron microscope confirms that the chloroplasts of *Anthoceros* resemble those of the algae, but the chloroplasts of *Megaceros*, which are several in each cell, often lack pyrenoids and possess well-defined grana. They thus resemble those of land plants generally.

Another feature of the Anthocerotales which has excited much attention is the axial form of the sporophyte, and the tendency in some species for the foot to produce rhizoid-like outgrowths into the tissue of the gametophyte. Since the sporophyte in some forms is long-lived and may even persist for a time after the death of the

parent gametophyte, it may indicate how simple axial plants, such as those of the Silurian and early Devonian (p. 135), have evolved. Alternatively the *Anthoceros* condition may be derived, the sporophyte having become reduced and almost deprived of its independence.

Although firm evidence relating to either possibility is lacking, it seems quite plausible that a growth form similar to that shown by the living Anthocerotales did play some part in the evolution of land plants from algal ancestors. Unfortunately the only fossils so far known attributable to the Anthocerotales are spores from the Tertiary.

Bryopsida (mosses)

The mosses are a class much greater in number and more widely distributed than the liverworts, occurring in almost every habitat supporting life. Apart from being the dominant vegetation in acid bogs, and alpine and arctic regions, they are a familiar feature of woodlands and hedgerows.

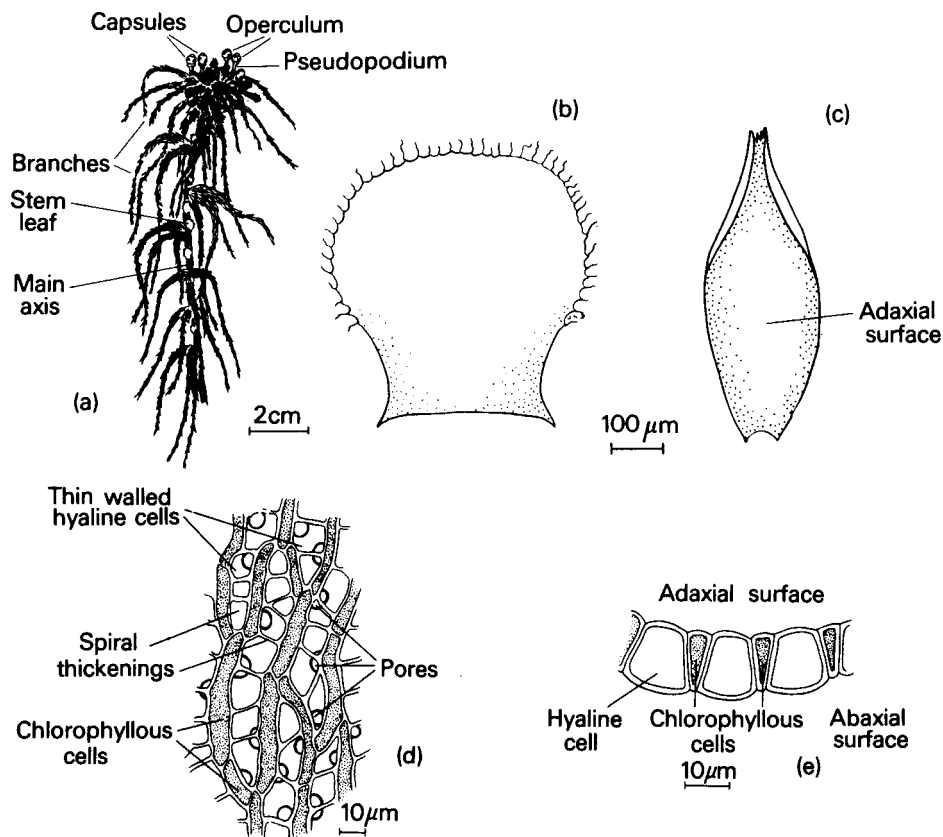

Figure 5.17 *Sphagnum fimbriatum*. (a) Upper portion of shoot with sporophytes. (b) Stem leaf. (c) Branch leaf. (d) Arrangement of cells in leaf, adaxial surface. (e) Section of leaf.

Some species even survive the polluted atmosphere of urban areas, often forming dark green cushions between paving stones and in other damp crevices. Mosses in exposed situations, including *Sphagnum* in bogs, often reach temperatures of 30–40 °C (86–104 °F). Isoprene production (p. 11), which is more common in mosses than in any other major group of land plants, increases in these conditions, and may consume up to 8 percent of the carbon fixed. As in other land plants, isoprene appears to be concerned with protecting the photosynthetic apparatus from excessive insolation and heating.

The features which distinguish the mosses from the liverworts are found in both gametophyte and sporophyte. The protonemal stage of the gametophyte is often conspicuous, the mature form of the gametophyte is always leafy, and the

rhizoids are multicellular. The sporophyte grows from an apical cell. The capsule in many instances has a complex opening mechanism which affects the distribution of the spores, and sterile elaters are never present.

The three orders, Sphagnales, Andreaeales and Bryales, differ principally in the nature of the protonema and the structure of the capsule. There are also differences in the ultrastructural detail of the spermatozoids (which resemble those of other bryophytes) which may have taxonomic significance.

The Sphagnales

The Sphagnales, a very distinctive order, are represented by a single genus, *Sphagnum*, confined to acid, waterlogged habitats. The more or less continuous spongy layer of peat bogs consists very largely of a range of *Sphagnum* species.

The adult gametophyte comprises an upright main axis from which whorls of branches arise at regular intervals (Fig. 5.17). The leaves, which are

closely inserted, have a peculiar structure which is diagnostic of the genus, and also, in its finer details, of the many species (Fig. 5.17c and d). When first formed, the leaves are made up of many diamond-shaped cells. These then cut off narrow daughter cells, but on two sides only. The daughter cells develop chloroplasts, but the mother cell remains colorless. It eventually dies, but before doing so pores are formed in its upper and lower walls and spiral bands of thickening are often laid down around the cell. The architecture of the leaf of *Sphagnum* thus provides a splendid example of the phenomenon of *apoptosis*, a pattern of programmed cell death being imposed upon the developing leaf. The cell-to-cell influences which determine this pattern are as yet wholly unknown.

The epidermis of the branches takes the form of a cylindrical sheet of empty elongated cells (termed "retort cells"), each with an apical pore open to the exterior. There is no evidence that these cells are formed by a sequence of divisions similar to that seen in the development of the empty cells of the leaf.

The empty cells of the mature leaf and branches are able to take up water and act as reservoirs. The weight of a saturated plant may be as much as 20 times that of the same plant dry. This unique water-storing capacity of the leaves accounts for the outstanding bog-building properties of *Sphagnum*. The acidity of the bogs is largely attributable to the presence of phenolic substances in the walls of the dead cells which act in the same way as ion-exchange resins. The growing plants extract metallic cations from inflowing waters and release hydrogen ions, so maintaining the acidity at values of around pH 4.0 or less. The lack of oxygen in the lower levels of the bog impedes oxidation of the organic matter, leading to accumulations of peat of considerable depth.

Well-preserved leaves similar to those of *Sphagnum* have been found in Permian deposits in Russia, indicating beyond doubt the great antiquity of this kind of construction.

REPRODUCTION

The reproduction of *Sphagnum* is probably principally vegetative, the decay of the older parts eventually causing branches to separate and thus to

become new individuals. Disks of *Sphagnum* peat from depths as great as 30 cm (12 in.) will produce innovative growths when exposed to light and a saturated atmosphere. These probably arise from the outer cortex of the buried stems. Some cells evidently remain viable and capable of division, possibly for as long as 60 years.

Mature plants in favorable situations produce sex organs freely. Both monoecious and dioecious species occur. The antheridia, each of which begins its development from a single apical cell, lie in the axils of leaves toward the tips of small upper branches (Fig. 5.18). These antheridial branches are often strongly pigmented and clustered in a conspicuous comal tuft. The female inflorescence consists of a bud-like aggregate of archegonia and bracts borne laterally near the summit of the main stem.

After fertilization the zygote yields a sporophyte (Fig. 5.17a) consisting principally of a capsule, containing a dome-shaped archesporium, and a foot. The seta remains inconspicuous, and the function of elevating the capsule is taken on by the base of the female inflorescence which, as the capsule matures, grows up as a leafless axis, or *pseudopodium* (Fig. 5.19). The absence of any cell extension in the seta, and correspondingly of any marked flux of fluid into the developing sporophyte, is correlated with the absence of labyrinthine walls at the interface of the two generations in the foot.

Release of the spores is brought about by air pressure which builds up in the lower half of the capsule as it dries (and may reach a level of 300 kPa (3 atm)). Eventually this pressure is sufficient to dislodge the clearly differentiated lid (operculum) with explosive force, and the spores are effectively dispersed.

Developing *Sphagnum* capsules are occasionally parasitized by a fungus (*Bryophytophyces*). Although the mature capsule may appear perfect, the small spores of the fungus replace those of the host. This gave rise to reports of heterospory in *Sphagnum* before the situation was understood.

Sphagnum spores germinate to form a filament, but this is rapidly replaced by a small thallose protonema. This in turn gives rise to a bud which develops into the familiar leafy gametophyte, the protonema meanwhile becoming

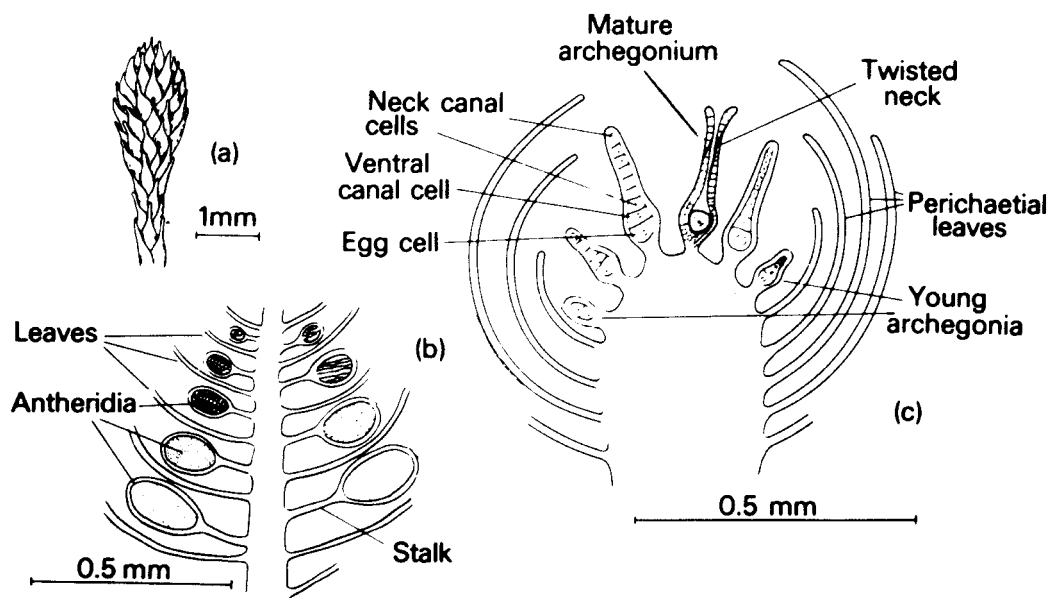

Figure 5.18 *Sphagnum* sp. (a) Antheridial branch. (b) Longitudinal section of antheridial branch. (c) Longitudinal section of archegonial branch.

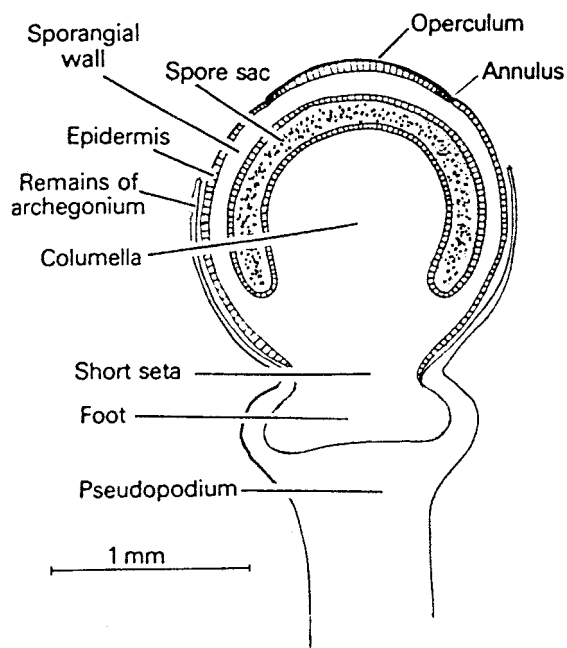

Figure 5.19 *Sphagnum* sp. Longitudinal section of nearly mature sporophyte.

moribund and disappearing. Protonemata also appear on disks of old peat maintained in humid conditions. Many appear to arise from spores within the compacted peat which have remained viable. Others are secondary in origin from viable cells in the old stems.

The Andreaeales

The Andreaeales are an order containing only three genera, distinguished by their peculiar capsules.

The leafy gametophyte of *Andreaea* (Fig. 5.20) rarely exceeds 1 cm (0.4 in.) in height. It is usually found growing on rock, chiefly in cold, exposed and relatively dry regions. The leaves are olive-brown in color, composed of rounded cells, and in most species showing no distinct midrib.

Sex organs are formed apically. The sporophyte resembles that of *Sphagnum* in having a domed archesporium (Fig. 5.20c), and in being borne on a pseudopodium at maturity. Dehiscence of the capsule takes place by four longitudinal slits which do not meet at the tip (Fig. 5.20b). The hygroscopic properties of the wall cause the slits to close in damp conditions, and to open again in dry (Fig. 5.20a).

The protonema of *Andreaea* is similar to that of *Sphagnum*.

Also placed in the Andreaeales is the recently

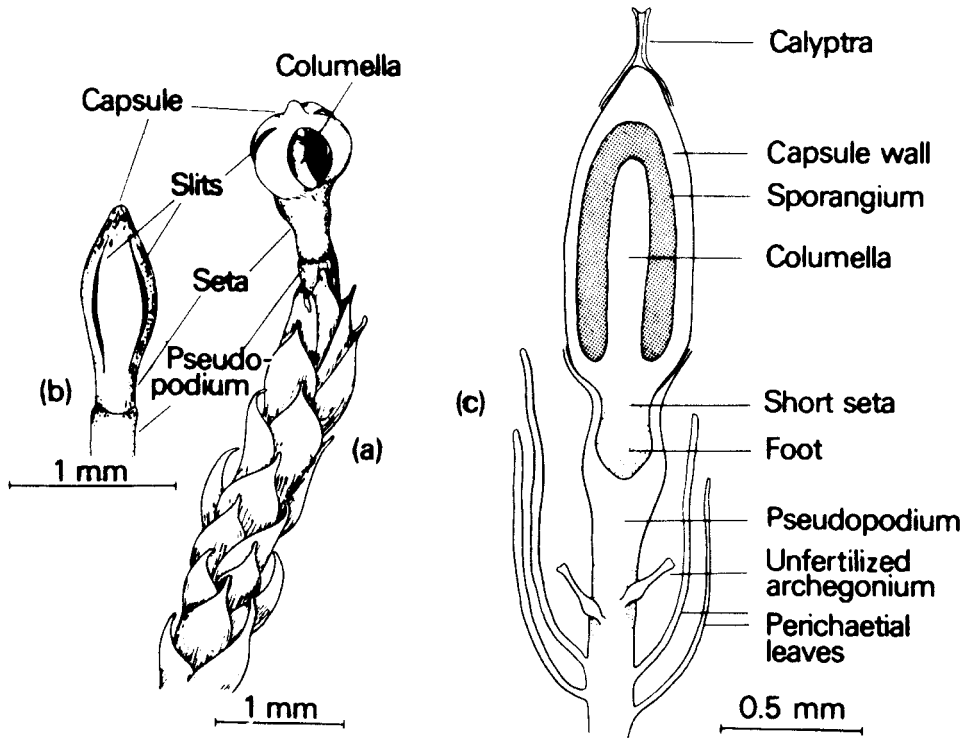

Figure 5.20 *Andreaea nivalis*. (a) Habit of fertile plant showing dehiscent capsule in dry condition. (b) Dehiscent capsule in wet condition. (c) Longitudinal section of mature sporophyte.

discovered *Andreaebryum*, growing in the oceanic northwest of Canada and Alaska. The capsule is elevated by a seta, and opens less regularly than in *Andreaea*. The protonema produces curious cylindrical multicellular processes which are green and presumably photosynthetic. Whereas *Andreaea* is usually found on siliceous rocks, *Andreaebryum* prefers a calcareous habitat.

Current evidence points to *Takakia* (p. 115) also being correctly placed here. This has a small upright stem, rising from a filiform rhizome, growing on soil partly covering rocks. It is confined to subalpine situations in Japan and the oceanic northwest of the American continent. The stems bear linear appendages ("phyllids"), usually in groups of two or three. The archegonia are terminal. The archesporium is domed, and the capsule lacks a peristome and lid. Dehiscence of the capsule takes place by a single slit which extends spirally from the base of the capsule to

the tip, a feature unique in the bryophytes. After rupture, the calyptra is carried up at the summit of the capsule, but becomes loose and fragmentary. The seta remains short and thick and does not attain the delicacy seen in many bryalean mosses. In structure and shape the foot resembles that of *Andreaea*. Although the recognition of *Takakia* as a moss appears well founded, a distant affinity with the Calobryales, particularly in respect of the archegonia terminating the leafy axes, remains a possibility.

The Bryales

The 600 or so genera of the Bryales form a well-defined order. Although there is a common basic morphology and life cycle within the order, the variation in size, detailed structure and habitat preferences is considerable. Many mosses are confined to permanently damp situations in woodlands and by springs, but others, for example *Tortula ruraliformis*, are able to survive periods of drought in sand dunes and other arid habitats. The cells of these species appear to have acquired the capacity to continue metabolism at a reduced rate while partially dehydrated. At the other

Figure 5.21 *Hypnum cupressiforme*.

(a) Fertile shoot system. (b) A portion of the shoot showing the closely inserted leaves. (c) Capsule, showing peristome in dry state. (d) Peristome in wet condition.

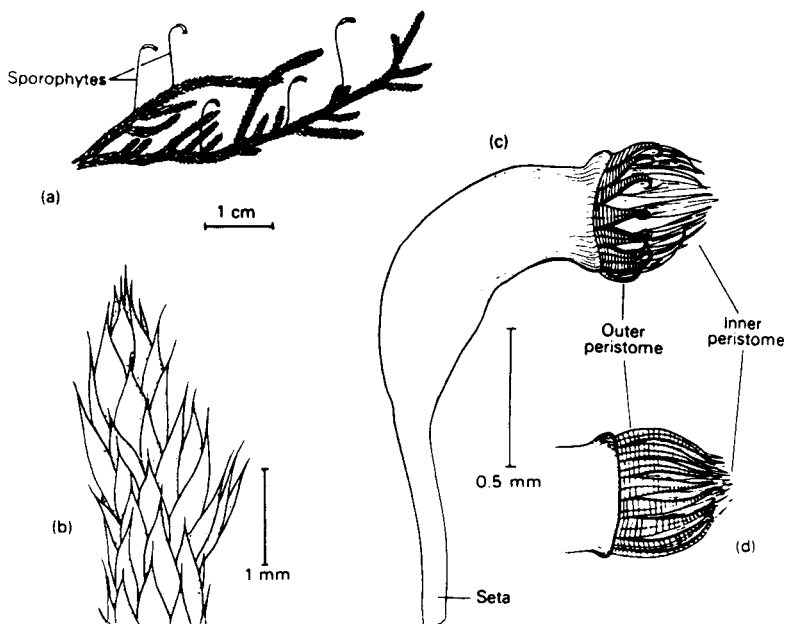

extreme are a few subaquatic species, such as *Fontinalis anti-pyretica*.

Some mosses are remarkably tolerant of heavy metals, and in some areas serve as “indicator” plants. The worldwide genus *Mielichhoferia*, for example, contains a number of species characteristic of acidic copper-bearing soils and rocks.

The most familiar form of the moss plant is the adult gametophyte (Figs. 5.21 and 5.26). This consists of a main axis growing from an apical cell and bearing leaves which, although usually spirally inserted, may in some forms come to lie on one plane. This gives the shoot a complanate appearance (e.g., *Neckera*, common on banks and rocks). In a few species (e.g., *Fissidens*) the insertion of the leaves is equitant and the leaves are arranged in two ranks. The leaves of most mosses consist of a single sheet of cells, although the central region may be thickened and contain a well-defined midrib (often referred to as a “nerve”), sometimes excurrent in a hyaline point. The most complex leaf is found in *Polytrichum* and its allies. Here a number of parallel longitudinal lamellae grow up from the upper surface (Fig. 5.22) and the chloroplasts occur principally in these cells. Air is able to circulate between the lamellae, and experiments have shown that they are sites of active photosynthesis. The shape of the leaf, and the nature and development of the midrib and of the cells at the margin of the leaf, feature prominently in the taxonomy of the mosses.

Anatomically, moss gametophytes offer little that is outstanding amongst land plants, the most complex differentiation being found in the stem of *Polytrichum* (Fig. 5.23). Not only is there an

approach here to the development of tracheids (but no evidence of lignification), but also a clear radially symmetrical zonation in structure, recalling that of the axes of some of the smaller filmy ferns. A core of thin-walled cells (*hydroids*), which are dead and empty at maturity, lies at the center. These have inclined end walls, and are able to conduct water and solutes. In the rhizome of *Polytrichum* (but less frequently in the upright stem) the hydroids are mixed with *stereids*, living cells usually with thickened lateral walls. Surrounding the hydroids is a zone of elongated elements tending to be swollen at their ends. These are the *leptoids*. Their end walls are inclined, calloused, and perforated by plasmodesmata. Although the nuclei are often degenerate, some protoplasmic contents persist. These include plastids with rudimentary thylakoids and plastoglobuli, mitochondria, and often conspicuous endoplasmic reticulum. Leptoids are believed to have a phloem-like function. There is a close structural similarity to the sieve cells of gymnosperms.

Although leptoids are found only in *Polytrichum* and its allies, a core of hydroids is found in many moss stems. Experiments have shown that, where present, the hydroids are the principal site of the internal conduction of water. In most mosses, however, there is also substantial apoplastic conduction, or even capillary conduc-

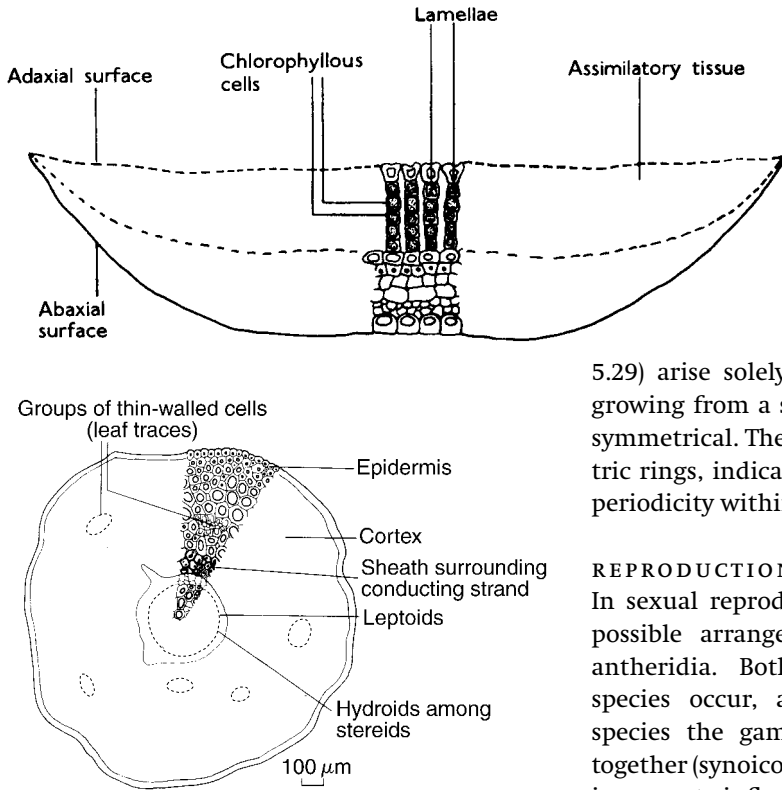

Figure 5.22 *Polytrichum commune*. Transverse section of leaf showing the assimilatory lamellae.

phase. The upright filaments resemble the chloronema, but in the prostrate (*caulonema*) the septa are oblique and the cells are yellowish in color. The buds yielding the mature form of the gametophyte (Fig.

5.29) arise solely on the caulonema. A culture growing from a single spore tends to be radially symmetrical. The buds arise in a series of concentric rings, indicative of a form of developmental periodicity within the culture.

REPRODUCTION

In sexual reproduction, the Bryales show every possible arrangement of the archegonia and antheridia. Both monoecious and dioecious species occur, and amongst the monoecious species the gametangia may be either mixed together (synoicous) in a bud-like inflorescence, or in separate inflorescences. Whatever the arrangement, the antheridia and archegonia are often numerous and interspersed with sterile hairs or paraphyses (Figs. 5.24 and 5.25), the whole cluster of sex organs commonly being surrounded by a whorl of closely adpressed leaves (*perichaetium* if female; *perigonium* if male). The archegonia usually have long necks, each consisting of several tiers of cells, and the central canal may contain as many as 10 cells. The antheridia are stalked, and one or more cells at the apex usually form a distinct lid at maturity, opening as if on a hinge while the mass of spermatocytes is discharged.

There is a striking correlation in the Bryales between the position on the plant where the sex organs are produced and the growth habit. Where the reproductive organs terminate the main axis, and growth is consequently sympodial, the main axis is almost invariably upright. These are the *acrocarpous* mosses. In the remainder, where the sex organs are produced laterally (the *pleurocarpous* mosses), the main axis is usually creeping (Fig. 5.21a). With only a few exceptions, the tufted mosses are acrocarpous. Photoperiod and temperature affect the onset of the sexual phase in many

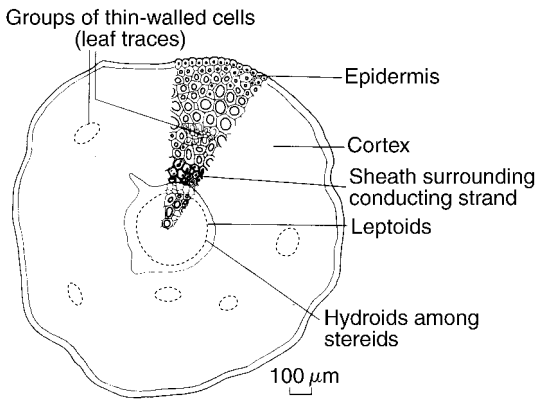

Figure 5.23 *Polytrichum commune*. Transverse section of stem. Stereids are more conspicuous in rhizomes than in aerial stems.

tion external to the stem facilitated by adpressed leaf bases or matted rhizoids. In some instances (e.g., *Thuidium tamariscinum*) the stem is clothed with a tomentum of green, branched, filamentous outgrowths (paraphyllia) which acts like a wick. In some other genera cells on the abaxial surface of the leaf bases lose their contents. Pores formed between them and to the exterior provide a system of superficial conducting channels. Such cells are referred to as “hyalocysts”.

DEVELOPMENT OF THE ADULT GAMETOPHYTE

In all Bryales the protonemal phase is conspicuous. In *Funaria* and some other mosses two distinct phases of protonemal development have been recognized. In the first (*chloronema*), which resembles a branching filamentous alga, the dividing walls are transverse and the cells bright green. This gives way to a strongly heterotrichous

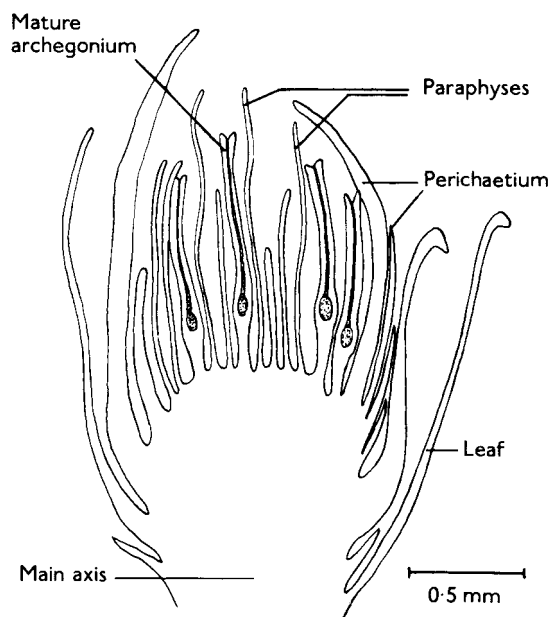

Figure 5.24 *Mnium* sp. Longitudinal section of female head.

mosses, and these factors are probably responsible for the annual reproductive cycle seen in many temperate species. In extreme conditions sexual cycles may become altogether erratic. Spermatogenesis, for example, seems particularly susceptible to damage by the low temperatures of polar regions, and widespread abortion of embryo sporophytes has also been observed in these situations.

The development of the sporophyte begins immediately after fertilization. A transverse wall divides the zygote into an upper and a lower (hypobasal) cell. Although in some mosses (e.g., *Funaria*) transverse and longitudinal divisions then form a three-dimensional embryo, in others continued transverse divisions of the hypobasal cell lead to a transient filamentous phase. In *Mnium hornum* and *Catherinea undulata* the filament may reach 7–9 cells in length. In some species the lower part of the filament appears to persist as a downward projection of the foot between the cells of the gametophyte (in *Molendoa hornschuchiana*, for example, this projection may reach a length of 275 μm).

In contrast to the liverworts, the extension of the seta begins well before the capsule is mature. The venter of the archegonium, also stimulated

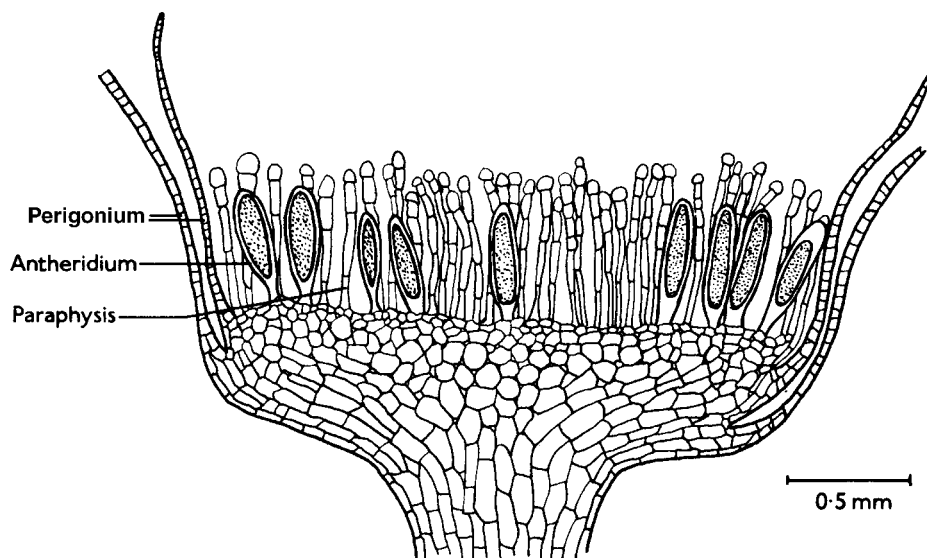

Figure 5.25 *Mnium hornum*. Longitudinal section of male head.

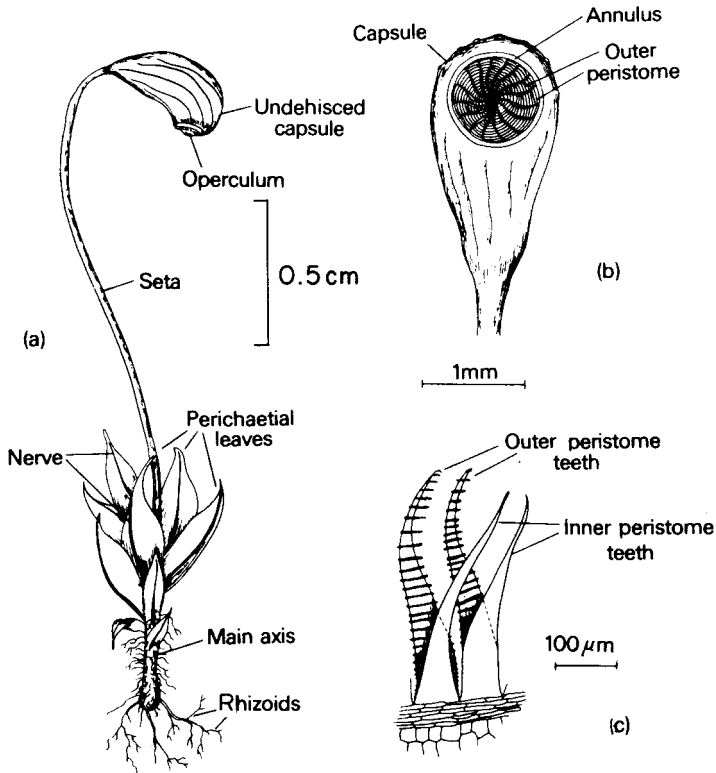

Figure 5.26 *Funaria hygrometrica*.

(a) Habit of fertile plant. (b) Mature capsule showing intact peristome. (c) Portion of peristome viewed from the inside.

vaginula without damage. In this way it has been possible to transfer the young sporophyte of *Dicranum scoparium* to the vaginula of *Catherinea undulata* (a totally unrelated species) and to obtain continued and normal growth of the foreign sporophyte (Fig. 5.28). This supports the view that the nutrition passing from gametophyte to sporophyte is of a quite general character, and that molecules that are informational and species-specific do not traverse the generational interface.

into growth by germination of the zygote, forms a cap-like calyptra covering the young sporophyte. Extension of the seta tears the calyptra away from the main body of the gametophyte, but in many species (e.g., *Funaria hygrometrica*) it continues tightly to ensheath the developing capsule. If the calyptra is removed prematurely, the capsule remains upright and symmetrical, instead of becoming arcuate (cf. Fig. 5.26a), and the apophysis (Fig. 5.27) and upper part of the seta become swollen. The influences emanating from the calyptra seem to be partly physical and partly chemical. Replacement of the calyptra with one of comparable morphology from another species eliminates the effects of removal. It is noteworthy that mosses in which the apophysis and upper part of the seta are normally swollen (e.g., *Oedipodium* and *Splachnum*) are characterized by poorly developed and loosely fitting calyptras.

The terminal part of the gametophyte which houses the foot of the sporophyte is termed the *vaginula*. Since there is no organic continuity between the two generations, the embryonic sporophyte can in some species be pulled from the

The capsule itself (Figs. 5.21, 5.26, 5.27 and 5.29) is a complex organ, but its differentiation follows a regular radial pattern, and two concentric regions of tissue can be recognized which follow distinct developmental paths. An inner region, termed the *endothecium*, gives rise to the archesporium, which in the Bryales is never domed but is always a cylinder, often with a central sterile columella. Outside the endothecium is the *amphithecium* which, in most Bryales, differentiates a ring of remarkable tooth-like structures, the *peristome*. This remains as a fringe around the mouth of the opened capsule (Figs. 5.21c and d and 5.26c). The peristome is developed from three layers of cells. Thickenings are laid down on both sides of the tangential walls bounding the middle layer. Only these thickenings remain at maturity. They then fall into a number of columns, each of which yields a peristome tooth. Because of the ordered sequence of mitoses in the differentiation of the amphithecium, and the regular spacing of the cells giving rise to the peristome, the number of teeth is constant in any given species and is always a power of 2. Where a peristome is fully developed (as in a moss such as

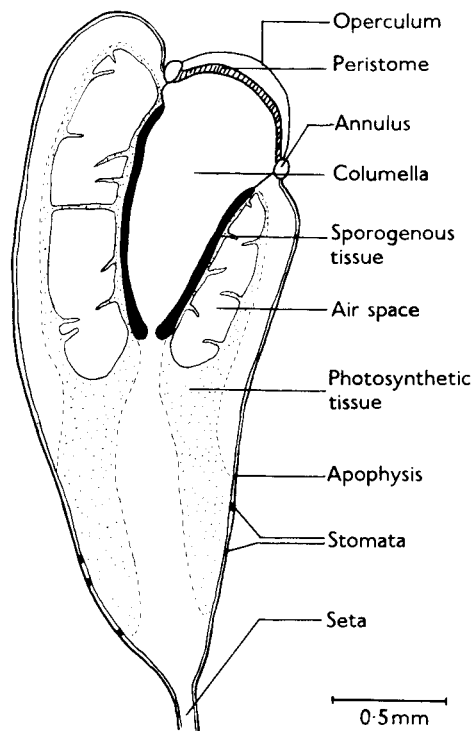

Figure 5.27 *Funaria hygrometrica*. Median longitudinal section of immature capsule.

Funaria), there are two concentric rings of teeth (Fig. 5.26c), but in other genera the inner teeth may be missing, or the whole peristome may be imperfect or rudimentary, or even absent.

Chlorophyllous tissue occurs in the immature capsule, particularly in the basal region (apophysis), where stomata are also found in the epidermis. The sporophyte is thus to some extent autotrophic. In some species (e.g., *Funaria hygrometrica*), air spaces occur between the archesporium and the wall of the capsule. This conspicuous aeration has perhaps been developed in relation to the respiratory demands of the developing archesporium. The seta frequently contains a strand of hydroids ascending from the foot into the base of the capsule. Leptoids are never present in the seta.

Meiosis within the spore mother cells is foreshadowed by the appearance of furrows indicating the site of the future dividing walls, accompanied by the siting of bundles of microtubules in anticipation of the imminent nuclear

divisions. The columella usually begins to break down at this stage and ultimately the cavity of the capsule is occupied solely by spores. When these are mature the operculum detaches itself, exposing the peristome (Figs. 5.21c and d and 5.26b), which now begins to play an important rôle in the dispersal of the spores. The polysaccharide material forming the peristome teeth is hygroscopic and, since the macromolecular orientations of the thickenings in the two columns of cells giving rise to a tooth differ, tensions are generated in the tooth with changes in its hydration. These are released by sharp twisting and bending movements. The peristome thus forms a very effective scattering mechanism, activated by changes in atmospheric humidity. The exact nature of the movements of the teeth varies with the species. In some Bryales, for example *Funaria hygrometrica*, the peristome is incurved when wet and recurved when dry, but in others the movements are less regular.

In *Pottia heimii* (widespread on soil near the sea) the peristome is rudimentary, and the lid of the capsule remains attached to the columella. The lid is raised in relation to the rest of the capsule in dry conditions, allowing escape of the spores, and lowered when wet. In *Polytrichum*, also lacking a peristome, the capsule remains closed by a diaphragm after shedding the operculum. The spores escape through pores around its edge (Fig. 5.32).

The number of spores in a capsule varies from a few thousand in species with small capsules to a million or more in those with large capsules. Although in dioecious mosses the male plants are often smaller than the female, differences in spore size correlated with sex are rare. The best-known example is provided by *Macromitrium* of the southern hemisphere. In some species of this genus the spores fall distinctly into two size classes, the smaller giving rise to diminutive male plants. The four spores in each tetrad are initially similar, but subsequently two become distinctly larger. Evidently there is segregation of sex at meiosis.

The spores of the Bryales have thin walls, and germinate rapidly on a damp surface. The duration of the protonemal phase varies widely. In some Bryales it is comparatively brief, but in

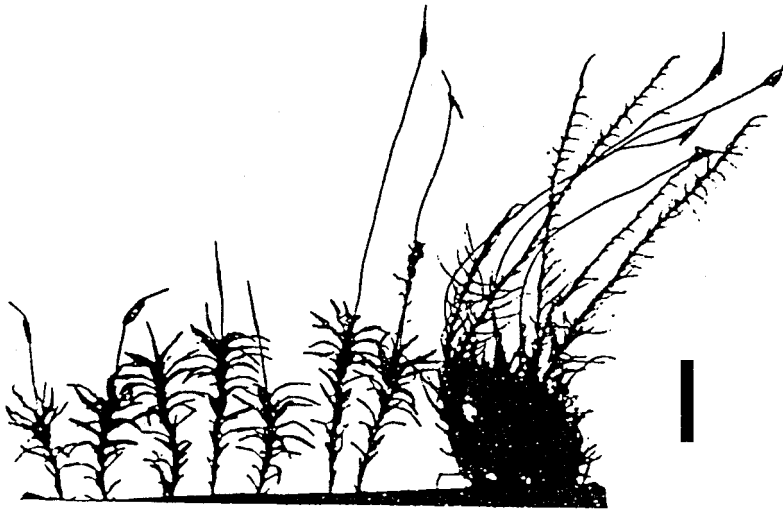

a b c d e f g h

Figure 5.28 Transplantation of sporophytes in the Bryales. (a,b) Control plants of *Catherinea undulata*; (c) *C. undulata* with a transplanted embryonic sporophyte of *Dicranum scoparium*; (d,e) *C. undulata* with sporophytes of *D. scoparium* three weeks after transplantation; (f,g) *C. undulata* with transplanted embryos of *D. scoparium* which have developed into normal mature sporogonia; (h) control plants of *D. scoparium*. Scale bar 1 cm. (From Arnadow, 1925. *Flora* 118/119.)



Figure 5.29 *Bryum pallens*, fruiting condition. Scale bar 1 cm.

others prolonged. In *Pogonatum aloides*, common on shaded acidic banks, the protonema persists as a dark green felt from which mature plants of limited life arise over a long period. A tropical example is the Southeast Asian *Ephemeropsis* which forms an extensive protonema on leaves. The mature plants arising from it are minute, consisting only of a few bracts surrounding sex organs. In species in which the protonema is of limited duration the protonemal state is often continued by small amounts of secondary protonema issuing from the bases of the mature plants. The protonema of *Tetraphis* is unusual in producing small leaf-like outgrowths.

In some mosses (for example *Dicnemon*, an Australasian epiphytic genus) the spores germinate in the capsule, so that the mature capsule appears to contain gemmae. If these multicellular nodules fall at a favorable site, they quickly yield leafy gametophytic buds. It is not clear whether each nodule comes from a single spore, or from a tetrad.

Vegetative propagation undoubtedly plays a large part in the asexual reproduction of the Bryales. Sometimes propagation is quite crude. Tufts of the moss *Grimmia longirostris*, for example, a species of the Andean paramo which grows on thin soil on rocks, become disrupted by frost. This results in "moss balls", small spheroidal masses of soil and the moss, which are then freely distributed by wind. Additionally, almost any part of an adult moss gametophyte – leaf, stem or even rhizoid – is capable of regeneration, usually yielding a secondary protonema. Ultimately buds are formed, as on the primary protonema, giving rise to new individuals (Fig. 5.30). Many species produce gemmae of characteristic shape. These serve as an ordered means of asexual reproduction. Their production may be general, or confined to certain regions of the plant, or even to specialized structures (Fig. 5.31). The separation of the gemmae from the parent plant is either schizolytic, as in the liverworts, or by the degeneration of a special *tmema* cell connecting the gemma to the parent (*lysigenic*). The release of the epiphyllous gemmae of some species of *Tortula* is schizolytic, and that of the gemmae of *Aulacomnium* (Figs. 31h and 32) lysigenic. The multicellular gemmae of some species are able to

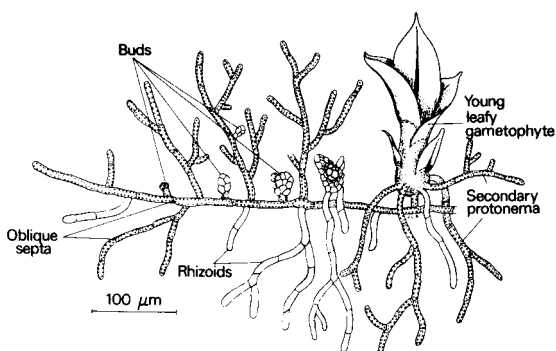

Figure 5.30 *Funaria hygrometrica*. Development of buds on protonema.

resist desiccation and remain viable for a considerable time.

The protonemal phase of mosses is also capable of asexual reproduction, but it is not clear how widespread this is in nature. In cultures of *Funaria hygrometrica* subjected to dry conditions, scattered cells of the chloronema differentiate into *brachyocytes*, thick-walled drought-resistant cells, accompanied on each side by *tmema* cells. The protonema then fragments, but growth can be re-established on hydration by germination of the brachyocytes. Experimentally the formation of brachyocytes can be induced by abscisic acid (ABA), but they dedifferentiate if ABA is removed from the medium. The chloroplasts in the brachyocytes adopt a curious cup-shaped form, the photosynthetic lamellae being confined to the rim.

Campylopus atrovirens is an example of a species which, although widely distributed, is hardly known in the sporophytic condition. Its dispersal must be almost entirely by asexual means, but no specialized propagules are produced.

THE BRYALES AS EXPERIMENTAL MATERIAL

The ease with which many mosses can be grown in pure culture on artificial media makes them very suitable for the experimental investigation of morphogenesis. Mutants of *Physcomitrella*, for example, are known in which the protonema will not produce buds unless cytokinin is added to the medium. The existence of mutants of this kind facilitates the investigation of the genetical and physiological factors bringing about the change

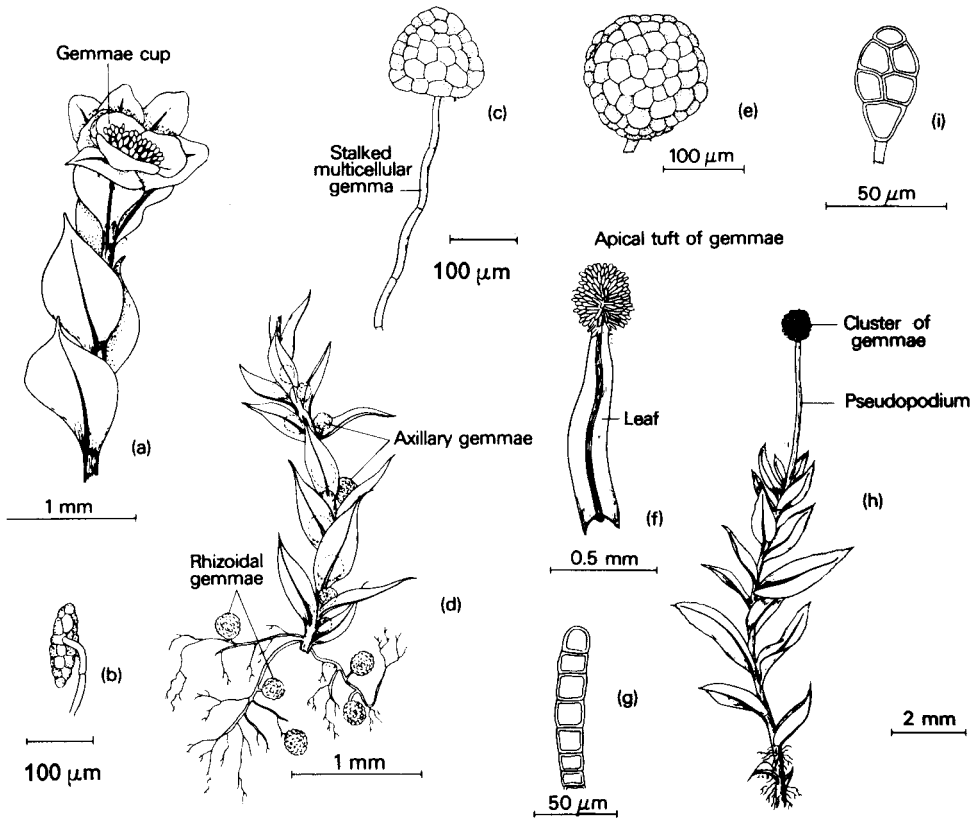

Figure 5.3 Asexual reproduction in mosses. (a–c) *Tetraphis pellucida*: (a) habit of gemmiferous plant; (b,c) mature gemma, front and side views. (d,e) *Bryum rubens*: (d) habit; (e) gemma. (f,g) *Uloa phyllantha*: (f) young leaf with apical tuft of gemmae; (g) gemma. (h,i) *Aulacomnium androgynum*: (h) habit; (i) gemma.

in form of growth. The results of experiments *in vitro* have nevertheless to be interpreted with caution. For example, when *Funaria* is grown in pure culture on medium containing activated charcoal the protonema produces buds as readily as on soil, but in the absence of charcoal they are delayed. It seems likely that the charcoal absorbs substances secreted by the protonema into the medium which would otherwise accumulate in the cells and have an inhibiting effect upon bud formation.

The Bryales were the first archegoniate plants in which it was discovered that portions of the sporophyte placed on a mineral-agar medium would give rise directly to gametophytic outgrowths (termed secondary protonemata)

without reduction of chromosome number (apospory). Although the mature forms of the diploid gametophytes are initially larger in all their parts than the haploid (the so-called *gigas* condition), this difference in size may be spontaneously lost and the haploid and diploid become indistinguishable. Diploid gametophytes have variable fertility, but with continued propagation they may become reproductively perfect and yield tetraploid sporophytes. Diploidization may occur spontaneously in nature, either by apospory or by the chance production of dyads of unreduced spores. Diploid races of *Funaria hygrometrica* have been encountered in the wild in Finland and California, and in Australia a population of the moss *Hypopterygium* on a single log was found to contain plants with several different levels of intraspecific polyploidy.

The determination of sex in the gametophytic phase of bryophytes presents a number of unsolved problems. The genotypic determination of sex in dioecious species of *Sphaerocarpos*,

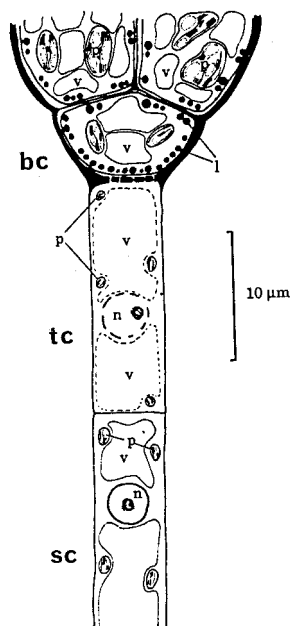

Figure 5.32 Position of the tmema cell beneath the maturing gemma of *Aulacomnium androgynum*. The contents of the fully extended tmema cell (tc) are beginning to degenerate, although its plastids (p) and nucleus (n) are still recognizable. Starch is accumulating in the plastids (p) of the gemma (only the lower part shown) and lipid droplets (l) at the periphery of its cells. bc, basal cell of gemma; sc, stalk cell; v, vacuole. (From Ligrone, Duckett and Gambardella. 1996. *Annals of Botany* 78.)

associated with chromosomal heteromorphy, seems clearly established. Similarly, in the moss *Macromitrium* (p. 126) evidence points to a Mendelian inheritance of sex. In some dioecious mosses, for example the common *Plagiomnium undulatum* and *Ceratodon purpureus*, although there is chromosomal heteromorphy the extent to which the pair of chromosomes concerned actually control sexual development is far less clear. Although in a population of *Ceratodon* male and female plants are more or less equally represented, careful observations have shown some families produce predominantly male offspring and others female. This may arise from unknown factors in different situations affecting germination of male and female spores differentially.

Often in monoecious mosses, as in the common *Funaria hygrometrica*, the male and female sex organs are borne on different branches

of the same plant (*autoecy*). Here sex expression must begin in somatic tissue, but experiments have failed to reveal at what stage expression is initiated, and results have been conflicting. Some investigators have found that, in *Funaria*, plants obtained by regeneration from leaves surrounding the male inflorescence (perigonal bracts) were exclusively male, but others have shown that plants obtained in this way remained autoecious. Even plants raised by regeneration from the base of the archegonium retained a bisexual tendency. In cases of synoecy, where the male and female sex organs are mixed together in the inflorescence (as in the widespread *Mnium cuspidatum*), sex determination must certainly be very local and effective only in the differentiation of the organs themselves.

Surprisingly, diploid plants of the common *Bryum caespitium*, a dioecious species, raised aposporously from sporophytic tissue, were found to be predominantly male. Although the form of growth was unambiguously gametophytic, in the presence of a diploid nucleus the expression of female sexuality in these experiments seemed to be largely suppressed.

Culture experiments have also revealed that the transition from gametophyte to sporophyte can also be induced directly (apogamy), but probably only with gametophytes which are at least diploid in constitution. *Phascum cuspidatum*, for example, obtained aposporously, will begin to produce sporogonia at the tips of leaves and elsewhere if the medium on which it is growing is allowed to dry. Rehydration results in the resumption of gametophytic growth. Some Bryales will produce sporogonia from secondary protonema if the medium is enriched with sugar. On an appropriate medium it has sometimes been possible to subculture these sporogonial cultures indefinitely. Aging cultures of *Physcomitrium pyriforme*, raised from spores, have been found, when transferred to fresh medium containing 2 percent sucrose, to produce sporogonia freely. This has been taken as evidence of the accumulation in the presence of sucrose of an "apogamy factor", able to bring about the switch from gametophytic to sporophytic morphogenesis in the absence of fertilization. Some of the sporogonia produced in these experiments yielded dyads of spores. These

germinated on basal medium and, in the presence of sucrose, continued to produce sporophytes apogamously in the same manner as the parental gametophytes. The indications are that results of this kind may be expected from the Bryales generally. They reveal that the expression of the genes controlling the kind of growth can be readily modified by nutrition and environmental stress. Indeed, the bryophytes as a whole offer splendid material for the experimental investigation of the factors controlling the morphogenetic and reproductive alternation in the archegoniate life cycle.

The morphogenetic effects of removing prematurely the calyptra from the developing capsule of *Funaria* (p. 125) recall the results of experiments with *Fucus* embryos (p. 91), where cell walls have been shown to retain the ability to determine the form of morphogenesis. The sporogonia of those mosses (p. 125) in which the upper part of the seta and the apophysis of the sporogonia are characteristically swollen may represent "natural evolutionary experiments" whose morphological results follow from mutations affecting the development of the calyptra.

Relationships of the bryophytes

Origin

The significant similarities, particularly in the protonemal phase, between the bryophytes and the algae provide compelling evidence that the mosses and liverworts had their origin in some algal form. Further, it is clear that the Bryophyta share many more basic features, such as the nature of the photosynthetic pigments, cell wall components and food reserves, with the Chlorophyta than with any other algae. Amongst the Chlorophyta are many examples of the heterotrichous habit and of oogamy, and in the Charophyceae of developments possibly foreshadowing the archegonium. The Charophyceae also share with the bryophytes the possession of the enzyme glycolate oxidase (p. 61), and the transfer RNA genes in the chloroplast genomes of the Charophyceae and bryophytes have striking molecular similarities.

The flagella of the spermatozoids of the bryo-

phytes and the charophycean algae are also of the same kind, and the multilayered structure underlying the flagellar bases in the bryophytes recalls similar structures in the motile stages of the Charophyceae. In the Charophyceae, however, the two centrioles which become flagella bases arise at right angles to each other, whereas in biflagellate land plants they are initially coaxial. Another significant difference is that, whereas the microtubular ribbon lies transverse to the plates of the multilayered structure in the Charophyceae, it is at an angle of 45° in the bryophytes. This results in the ribbon following a curved path in the bryophyte spermatozoid, contrasting with the situation in *Coleochaete* (p. 65). These differences, however, appear to be of detail rather than substance.

It is clear, nevertheless, that the Bryophyta are considerably more highly organized than any Chlorophyta. This is shown by their terrestrial habit, differentiated thallus, regular phasic alternation of gametophyte and sporophyte, and the production of aerial spores. The manner in which the reproductive organs are enclosed in a wall of sterile cells also contrasts with the naked gametangia and sporangia customary in most Chlorophyta.

Although the Charophyceae indicate how archegonia and antheridia may have evolved, little information is available about the origin of the bryophytes themselves. A possible form transitional between the algal and bryophyte grades of reproduction was *Parka* (p. 65), locally frequent in the upper Silurian and Lower Devonian, but for reasons given earlier this seems unlikely to have been an ancestral form. *Protosalvinia* of the Upper Devonian (p. 93), despite the indications of land plant features, is also generally considered to have been closer to the algae.

In the absence of well-defined remains we can only speculate how a bryophyte might have evolved from algal ancestors. A thallose liverwort like *Pellia*, for example, could have been derived from a heterotrichous form in which the prostrate component had become parenchymatous (a tendency already evident in some species of *Coleochaete*) and adopted dichotomous growth, the aerial component meanwhile being lost. Heteromorphic life cycles in the trans migrant

forms would have been no novelty since they are well represented in the algae, but examples of non-motile spores, such as those produced by *Dictyota* (p. 92), are few. The evolution of non-motile spores with a well-developed exine (of which sporopollenin was a prominent component), an essential for terrestrial life, thus probably accompanied the transmigration. Algal forms which may have developed these features (e.g., *Protosalvinia*, p. 93) did not survive.

The fossil record gives little information about the earliest bryophytes. Spore dyads and permanent tetrads (some membrane-bound) are known from the Silurian, and are considered by some to be similar to those produced by living Sphaerocarpaceae (p. 115). Similar spore types have, however, been encountered in the sporangia of rhyniophyte-like plants (p. 135). Such dyads and tetrads now appear to have been not infrequent amongst the earliest land plants, be they bryophytes, tracheophytes, or of some intermediate evolutionary grade.

The possible bryophytes from Devonian rocks are usually so ill preserved that their exact status is uncertain. The most promising candidate is perhaps *Sporogonites* from the Lower Devonian, a form in which a number of capsules with stalks a few centimeters in height seem to be arising from a presumably creeping thallus. Unfortunately no detail can be discerned and the bryophytic nature of the fossil must remain conjectural. So far, the fossil record is wholly silent on how the ancestral organisms gave rise to the sporophytes characteristic of bryophytes.

The morphological and reproductive differences between the mosses and liverworts appear to extend as far back as the Carboniferous, since the general classification of the fossil bryophytes from these ancient rocks is readily apparent. Examples of liverworts have already been mentioned (p. 114). Amongst the mosses *Muscites* from the Upper Carboniferous can be accepted as a member of the Bryales. Several convincing fossil mosses are known from the Permian. These findings strengthen the view that mosses and liverworts have been independent evolutionary lines from a very early period, and it is even possible that they had independent origins from transitional archegoniate forms. Nevertheless,

studies of mitochondrial DNA point to the earliest land plants having been liverwort-like. The liverworts, in common with all the Chlorophyta so far examined, lack two introns in this organellar DNA. These introns are present in mosses, and almost without exception in vascular plants.

Apart from their archegoniate reproduction, bryophytes have no obvious relationships with even the simplest vascular plants, living or fossil. A number of fossils from the Rhynie Chert (p. 139) may have belonged to plants intermediate between Bryophyta and Tracheophyta, but the evidence is not conclusive. The Bryophyta appear never to have been a major component of the Earth's vegetation, although they may have been conspicuous in the Carboniferous forests. They have probably remained isolated from the main line of evolution of land plants, changing only slowly, and exploiting a relatively circumscribed ecological niche. The failure to reach the morphological complexity characteristic of the remainder of the land flora may have been a consequence of the restriction of independence to the gametophytic phase in the life cycle. A haploid organism has no possibility of carrying a reservoir of variability in the form of recessive genes, capable of being advantageously expressed in future chance recombinations. This argument clearly has to be used with caution in respect of the notable number of diploid mosses now known. Such doubling of the gametophytic chromosome numbers probably, however, came too late to disrupt the well-established morphology of the cycle. Despite the factors limiting the evolutionary advance of the gametophytic phase, a number of anatomical and morphological trends have been strikingly similar in bryophytes and vascular plants. Bryophytes, for example, have acquired both leafiness and, in the stem of *Polytrichum*, a rudimentary vascular strand, the elements of which superficially resemble, structurally and functionally, xylem and phloem. Although there are undoubted similarities between the conducting elements occurring in some bryophytes and those of the early tracheophytes (particularly those of the Rhyniopsida (p. 139)), detailed studies reveal major differences in cell wall organization. Gametophytic and sporophytic organisms have evidently responded in a similar manner to

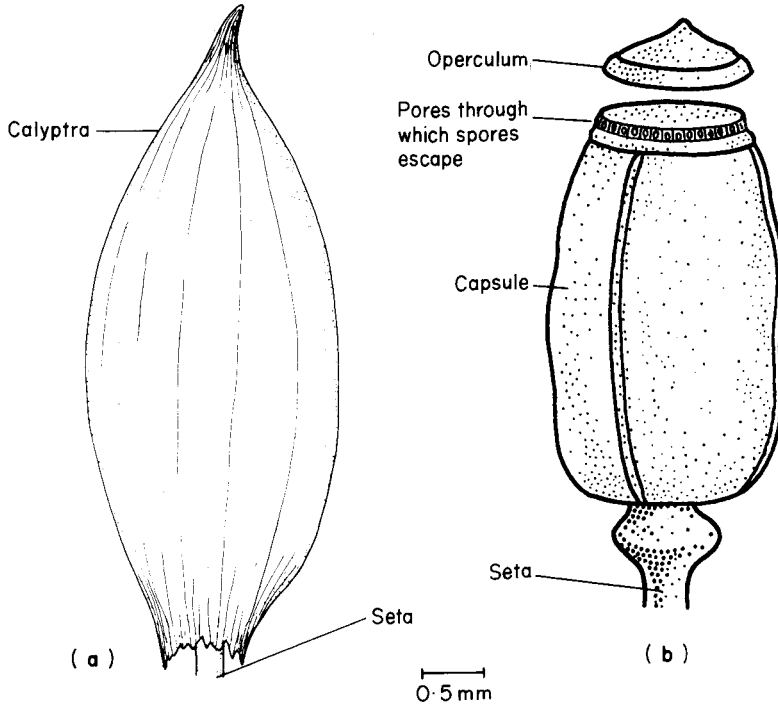

Figure 5.33 *Polytrichum juniperinum*, capsule. (a) Before removal of calyptra. (b) Operculum removed showing "pepper-pot" mechanism.

strengthened by the surprisingly complex features present in many of the thalloid forms (e.g., in *Marchantia* and *Anthoceros*), and the readiness with which, in leafy forms, experimental treatments can cause a reversal to radial symmetry (p. 111). Also, a thalloid form such as *Pellia* is so outstandingly simple that it stands under the suspicion of being reduced and specialized.

Similar arguments apply to the mosses, although here the relative uniformity of the

group makes comparative morphology even less informative. Few would regard those species whose capsules possess only rudimentary peristomes, or even lack them altogether, as anything other than reduced. The moss capsule with its clearly differentiated operculum and peristome must therefore have been an early and distinguishing feature of the class. Capsules which are clearly referable to a *Dicranum*-like moss, for example, have been found in late Cretaceous deposits. There is no direct evidence of how peristomes evolved, but it is possible that the "pepper-pot" mechanism present at the mouth of the capsule of *Polytrichum* (Fig. 5.33), and the bristle-like peristome found in a few other genera, indicate steps in a developmental pathway that culminated in the typical peristome of the Bryales (p. 125). Well-preserved specimens of *Polytrichum*-like capsules, and associated gametophytic axes, are also known from the late Cretaceous, so it appears beyond doubt that considerable diversification of the moss flora had already taken place by the end of the Mesozoic.

Evolutionary relationships

The evolutionary relationships within the mosses and liverworts themselves are also obscure. The liverworts, for example, show a whole series of forms from the creeping thallus (e.g., *Pellia*), to thalloid with two rows of ventral scales (e.g., *Blasia*), thalloid in which the margin of the thallus is so deeply crenulate that the lobes resemble leaves (e.g., *Fossombronia*), and ultimately leafy forms with upright stems and radial symmetry (e.g., *Haplomitrium* of the Calobryales). There has been much argument about whether this series represented a phylogenetic advance, or whether the first liverworts resembled *Haplomitrium*, the other forms being derived. The view that the radially symmetrical leafy form is primitive is

common environmental factors. The evolution of their conducting systems appears to have occurred in parallel, providing no evidence for a direct phylogenetic relationship between the systems of bryophytes and those of tracheophytes. Overall, the achievement of the bryophytes in the generation of diversity in form, stature and reproductive novelty has, in comparison with the tracheophytes, been modest.

Although we must regard the basic morphological features of the bryophytes as having arisen very early in the evolution of land plants,

evolution of a more superficial nature has no doubt continued in the division, its nature probably being influenced by evolution of vegetation as a whole. Amongst the mosses, widespread polyploidy probably facilitated this more limited adaptive variation. We can envisage that the rise of the angiospermous forests in the Cretaceous

provided many new surfaces well suited for colonization. A renewed burst of evolution, consisting principally of diversification of already established morphological forms, may have occurred at this time leading to the substantial epiphytic element in the existing bryophyte flora.

The subkingdom Embryophyta (cont.): division Tracheophyta, Part I

Early fossil land plants of simple construction

Although trilete spores are known from the mid-Ordovician and early Silurian, undisputed vascular plants are not found until halfway through the Silurian. A number of these lack true tracheids (“protracheophytes”) or are insufficiently well preserved to allow us to be sure of the presence of tracheids (“rhyniophytoids”).

The earliest accepted tracheophyte-like plant is *Cooksonia*. Several species are now known ranging from the upper Silurian to the Lower Devonian. *Cooksonia* was evidently widespread, occurring in a number of localities in North and South America and Europe. The plants were dichotomously branched (Fig. 6.1a) and probably formed swards, perhaps in swampy areas, a few centimetres in height. The axes, which were bare of any appendages, terminated in reniform (Fig. 6.1b and c) or globose sporangia with little evidence of predetermined sites of dehiscence. So far as known, *Cooksonia* was homosporous. Vegetative axes of some species have been found with a simple strand of tracheids (true tracheophytes), but others appear to lack them (“rhyniophytoids”). The presence of stomata-like pores has been confirmed only in forms from the earliest Devonian. There is as yet no evidence of extensive aerating systems in *Cooksonia* which might support the suggestion that carbon dioxide was taken up through the

underground organs (as in *Isoetes* and a few other living plants). Nothing is known of a gametophytic phase, but the spores, since they bear a trilete scar, were presumably produced meiotically in tetrads.

These early plants, which seem to have had little obvious diversity in overall morphology, other than in the spore types they produced, seem to have given rise to a number of groups of land plants. These include the Rhyniopsida (plants with mostly terminal sporangia), the Lycopodiopsida and the Zosterophylloids (plants with mostly lateral sporangia, probably derived by some form of “overtopping” (Fig. 6.32) from the Rhyniopsida), and further “protracheophytes” and “rhyniophytoids” which were morphologically similar to the Rhyniopsida. In some respects the “protracheophytes” and the “rhyniophytoids” show similarities to bryophytes, or at least a bryophytic grade of evolution. They differ, however, in each sporophyte commonly bearing multiple or branched sporangia. The relationship between them and the bryophytes remains wholly unclear.

“Protracheophytes” and “rhyniophytoids”

In addition to those species of *Cooksonia* in which we have no evidence of tracheids, a number of simple, dichotomously branched plants occur in the late Silurian and are currently referable to the “rhyniophytoids”. These include *Caia*, with upright cylindrical sporangia bearing surface projections, and *Tortilicaulis*, the sporangia of which had helically aligned epidermal cells, possibly

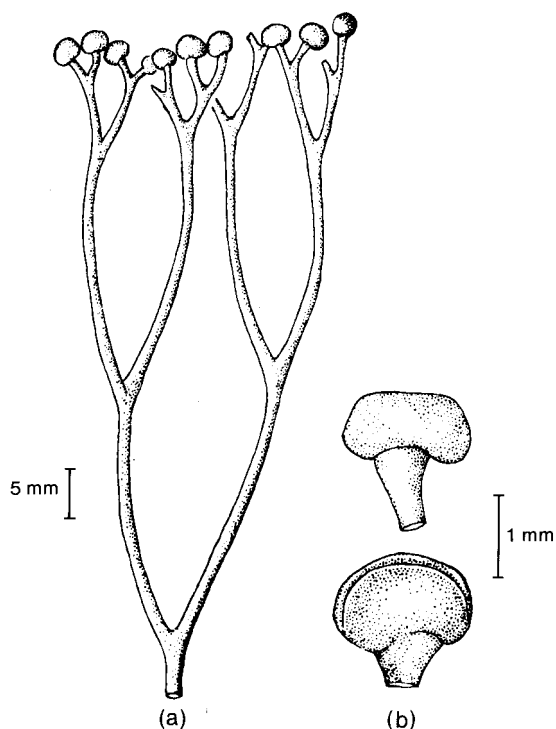

Figure 6.1 *Cooksonia*. (a) Habit. (b,c) Terminal reniform sporangia of *C. caledonica*. Scale bar in (c) 1 mm. The specimen is from the Lower Devonian of Scotland. ((a), (b) after Edwards, from Stewart, 1983. *Paleobotany and the Evolution of Plants*. Cambridge University Press, New York.)



facilitating dehiscence. Other than the spores, nothing is known of a gametophytic phase.

“Protracheophytes” persisted into the Lower Devonian. Fine specimens are known from the Rhynie Chert in Scotland. Not only is the preservation remarkable, but also the extensive remains have provided considerable information regarding an alternation of generations in these plants. *Aglaophyton* (Fig. 6.2) was superficially similar to *Rhynia* (p. 139), and was formerly known as *R. major*. The branching of the aerial axes of *Aglaophyton*, however, was wholly dichotomous, and the central strand consisted of cells which lacked the internal thickenings characteristic of tracheophytes. *Lyonophyton*, most likely from anatomical similarities to have been the gametophytic phase of *Aglaophyton*, appears to have consisted of ascending axes, with stomata-like pores in the epidermis and a general similarity to those of the sporophyte, but terminating above in

a peripherally lobed, bowl-shaped structure (Fig. 6.3a). On the inner surface of the bowl were rounded emergences with dark contents (Fig. 6.3b). Occasional sections of these emergences reveal within the cells profiles of coiled bodies. These can reasonably be identified with flagellate spermatozoids, pointing to these structures having been antheridia. Other sections show short, tubular extensions arising from a disk at the base of the bowl. These have been interpreted as the necks of archegonia (Fig. 6.3b), but this identification is less certain. *Sciadophyton* was a gametophyte similar to *Lyonophyton*. The axes diverged from a central corm-like structure (Fig. 6.3c) and terminated in bowl-shaped gametangio-phores bearing antheridia and archegonia (Fig. 6.3d). The affinity of this gametophyte may lie with the early Zosterophyllopsida (p. 141).

Horneophyton (Fig. 6.4) also occurs in the Rhynie assemblage. This plant had dichotomizing aerial

axes, reaching a height of about 20 cm (8 in.). The axes arose from a sequence of corm-like structures, each richly furnished with unicellular rhizoids. Sporangia were terminal, the sporogenous tissue surrounding a central columella, recalling the situation in the sporogonium of *Anthoceros*. Unlike those of *Anthoceros*, the sporangia of *Horneophyton* often dichotomized, occasionally as many as three times. Plants possessed a well-defined cuticle, stomata, and air spaces in the cortex. The spores, as evidenced by the triradiate scar, were produced meiotically in tetrahedral tetrads (Fig. 6.31). They were protected by a resistant wall, presumably containing sporopollenin. The exact nature of the conducting elements in the central strand of the axes is not yet clear, but it may yet emerge that *Horneophyton* was a true tracheophyte, and a member of the Rhyniopsida. The gametophyte *Langiophyton*, also described from the Rhynie Chert, may have belonged to *Horneophyton*. This bore gametangiophores with finger-like processes at the apex, each of which contained an archegonium.

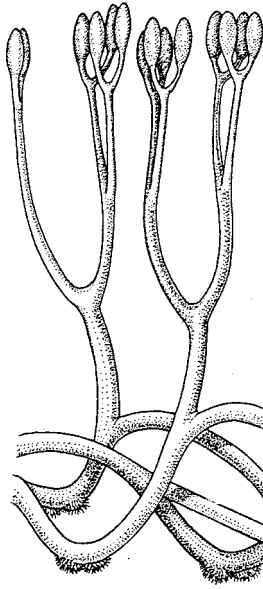

Figure 6.2 *Aglaophyton (Rhynia) major*, reconstruction. Scale bar 1 mm. (From Kenrick and Crane. 1997. *The Origin and Early Diversification of Land Plants*. Smithsonian Institution, Washington, DC.)

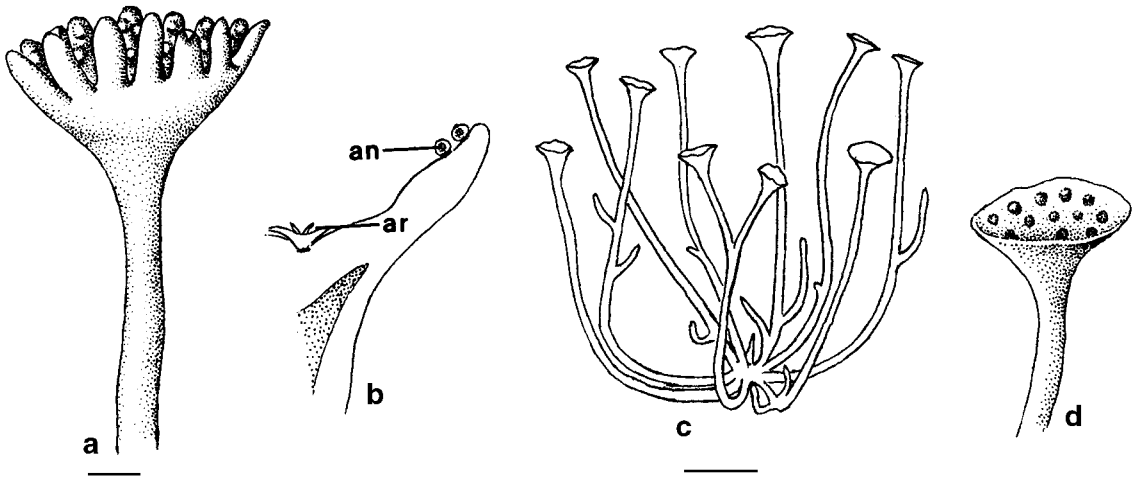
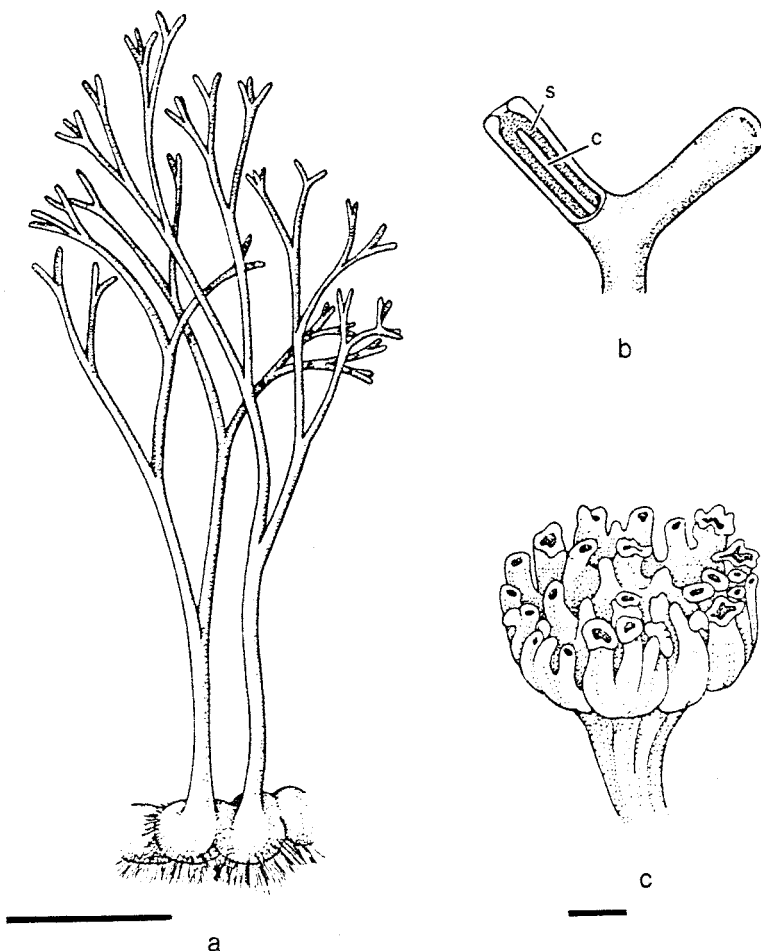

Figure 6.3 Gametophytes of Devonian plants. (a) *Lyonophyton*. Axis terminating in a bowl-shaped gametangiophore. Scale bar 1 mm. (b) Part of a vertical section of a gametangiophore, showing the relative positions of antheridia (an) and possibly archegonia (ar). (c) *Sciadophyton*. Upright axes ascending from a corm-like base. Scale bar 1 cm. (d) An axis terminating in a cup-shaped gametangiophore. (From Stewart and Rothwell. 1993. *Paleobotany and the Evolution of Plants*, 2nd edn. Cambridge University Press, New York.)

Figure 6.4 *Horneophyton*. (a)

Reconstruction of sporophyte. Scale bar 1 cm. (b) Diagrammatic representation of bifurcate sporangium with spores (s) and central columella (c). (c) Tip of branch of putative gametophyte (*Langiophyton*) with finger-like appendages within which archegonia were borne. Scale bar 1 mm. (From Kenrick and Crane, 1997. *The Origin and Early Diversification of Land Plants*. Smithsonian Institution, Washington, DC.)



These later “protracheophytes” appear to provide strong evidence for the homologous origin of the two phases of the life cycle in early land plants. The alternative, the “antithetic theory”, holds that the establishment of a distinct sporophytic phase was coincident with the colonization of the land. Although at first a simple structure, it became increasingly elaborate as the land flora evolved. So long as the gametophyte of *Cooksonia* remains unknown, the ancestral state in terrestrial plants bearing multiple sporangia can only be conjectural. It should not be overlooked that, if spore tetrads are a firm indication of meiosis and the presence of a life cycle, the first embryophytes occurred at least 50 million years earlier than the Rhynie assemblage.

General features of the tracheophytes

All vascular plants (i.e., those possessing the lignified conducting tissue, xylem) are placed in a single division (phylum), the Tracheophyta. Discussion of the many classes which comprise the Tracheophyta, and their interrelationships, will occupy the remaining chapters of this book.

The general characteristics of the Tracheophyta may be defined as follows:

TRACHEOPHYTA

Habitat Predominantly terrestrial or epiphytic.

Plastid pigments Chlorophylls *a*, *b*; carotenoids (principally β -carotene); xanthophylls (usually principally lutein).

Food reserves Starch; to a lesser extent fats, inulin and other polysaccharides. Proteins.

Cell wall components Cellulose, hemicelluloses, lignin.

Reproduction Heteromorphic life cycle; sporophyte the conspicuous phase, its growth usually indeterminate. Sex organs with or without a jacket of sterile cells. Male gametes bi- or multiflagellate, or lacking flagella. Embryogeny rarely exoscopic, embryo in many enclosed in a seed. Spores rarely green, usually with well-defined wall (exine) impregnated with sporopollenin. Often of two sizes, produced in different

sporangia, the larger (megaspores) female and smaller (microspores) male (heterospory). Specialized vegetative reproduction of the sporophyte infrequent.

Growth forms Predominantly axial.

The Tracheophyta fall into a number of categories (Table 6.1; Fig. 6.5), of which many orders and some classes are represented solely by fossils. Those living tracheophytes which reproduce by spores (as opposed to seeds) are often referred to collectively as the pteridophytes (Pteridophytina). The tracheophytes as a whole have an abundant fossil record.

Most of the living tracheophytes are seed-bearing (Spermatophytina), and most of these in turn are angiosperms (flowering plants), in which the female gametophyte is characteristically the embryo sac. The typical pteridophyte archegonium is wholly absent. Angiosperms number about 250,000 species, and in many plant communities they are the principal component of the flora. Nevertheless, they have evolved only recently in relation to the history of the tracheophytes as a whole (see Table 6.1), and their dominance is a comparatively new feature in world vegetation.

The remainder of the Tracheophyta, with the exception of a few gymnosperms (non-flowering seed-bearing plants), are archegoniate and their fossil record extends back in some instances well into the Paleozoic (up to 415 million years ago). Taken as a whole, the archegoniate Tracheophyta show a progressive ability to exploit terrestrial habitats. The steps which led to the development of heterospory from homospority, and the elimination of the necessity of free fluid for fertilization, are indicated clearly in a variety of living and fossil groups. The progression from simple heterospory to elaborate seeds is also evident in fossil forms. These reproductive changes were accompanied by increasing protection of the plant body from unfavorable climatic conditions, thus widely extending the range of environments available to plant life. The emergence and diversification of the angiosperms involved the exploitation of many features which originated in early tracheophyte evolution.

A feature common to all living homosporous

Tracheophyta is the presence in the sporangium of one or more concentric layers of cells surrounding the sporocytes. These cells break down progressively during meiosis. The materials so liberated are utilized in the final differentiation of the spores, including the ultimate stages in the laying down of the exine. This specialized tissue is referred to as the *tapetum*. In the tracheophytes which are both heterosporous and seed-bearing the tapetum is well represented in the microsporangia, less so in the megasporangia.

Rhyniopsida

This extinct group is ancestral amongst tracheophytes. It contains those species of *Cooksonia* (p. 135) known to have possessed tracheids with internal thickenings. As knowledge of the anatomy of the “rhyniophytoids” and “protracheophytes” expands, some of these may prove to have been early rhyniopsids.

Rhynia gwynne-vaughanii (Fig. 6.6) from the Rhynie Chert (Lower Devonian) had branching aerial stems arising from a horizontal rhizome attached to the substratum by fine rhizoids. The ascending axes, with both dichotomous and lateral branching, reached a height of about 20 cm (8 in.). Some of the axes terminated in fusiform sporangia. The sporangium was apparently shed after release of the spores, the fertile axis then being overtopped by the subjacent lateral so giving the branching a monopodial character. Both the rhizome and the aerial shoots had a central strand of tracheids, the protoxylem lying at the center (mesarch). The tracheids were surrounded by cells resembling the leptoids of mosses (p. 122).

The tracheids of the Rhyniopsida as a whole had annular or spiral thickenings. The inner surface of the wall was covered with a thin layer of resistant material furnished with minute pores. This was laid down on material appearing “spongy” in the fossilized state (possibly because of partial resistance to degradation). These features of the wall distinguish the tracheids of the Rhyniopsida from those of the Lycophytina (p. 151) and Euphyllophytina (p. 162). Water-conducting systems may have evolved several times independently during the migration to land (see also pp. 111, 132).

Table 6.1 Classification of division Tracheophyta.

Subdivision		Class	Order	
Pteridophytina (Spore-bearing vascular plants)	(PTERIDOPHYTES) (LYCOPHYTINA Plants with laterally derived sporangia)	Rhyniopsida	Rhyniales	
		Zosterophyllopsida	Zosterophyllales Barinophytales ^b	
		Lycopodiopsida (CLUB MOSSES)	Drepanophycales Protolpidodendrales Lycopodiales ^a Lepidodendrales ^b Isoetales ^{a,b} Selaginellales ^{a,b}	
		(EUPHYLLOPHYTINA Plants with terminally derived sporangia)	Trimerophytopsida Equisetopsida (HORSETAILS)	Trimerophytales Calamitales ^b Equisetales ^a Sphenophyllales ^b Pseudoborniales
		Cladoxylopsida Polypodiopsida (FERNS) (Eusporangiatae)	Cladoxylales Zygopteridales ^b Marattiales ^a Ophioglossales ^a Psilotales ^a	
	(Plants with gymnospermic wood)	(Annulate sporangia) (Leptosporangiatae)	Osmundales ^a Coenopteridales Polypodiales ^a Salviniales ^{a,b} Marsileales ^{a,b}	
	Spermatophytina (Seed-bearing plants)	(GYMNOSPERMS)	(Progymnospermopsida)	Aneurophytales Protopytales Archaeopteridales ^b
			Lyginopteridopsida (PTERIDOSPERMS)	Lyginopteridales Medullosales
			Pinopsida (PINE-like plants)	Cordaitales Voltziales Pinales ^a Taxales ^a
			Ginkgoopsida Cycadopsida (CYCAD-like plants)	Ginkgoales ^a Cycadales ^a Glossopteridales Caytoniales
(ANTHOPHYTES)			Bennettitales Pentoxylales	
(Double fertilization) (ANGIOSPERMS) (Plants with flowers)		Gnetopsida (CHLAMYDOSPERMS)	Gnetales ^a Welwitschiales ^a Ephedrales ^a	
		Magnoliopsida (DICOTYLEDONS)	Around 64 orders in six subclasses ^a	
		Liliopsida (MONOCOTYLEDONS)	Around 20 orders in three subclasses ^a	

Notes:

^a Denotes living representatives. ^b Denotes the occurrence of heterospory within pteridophytic groups.

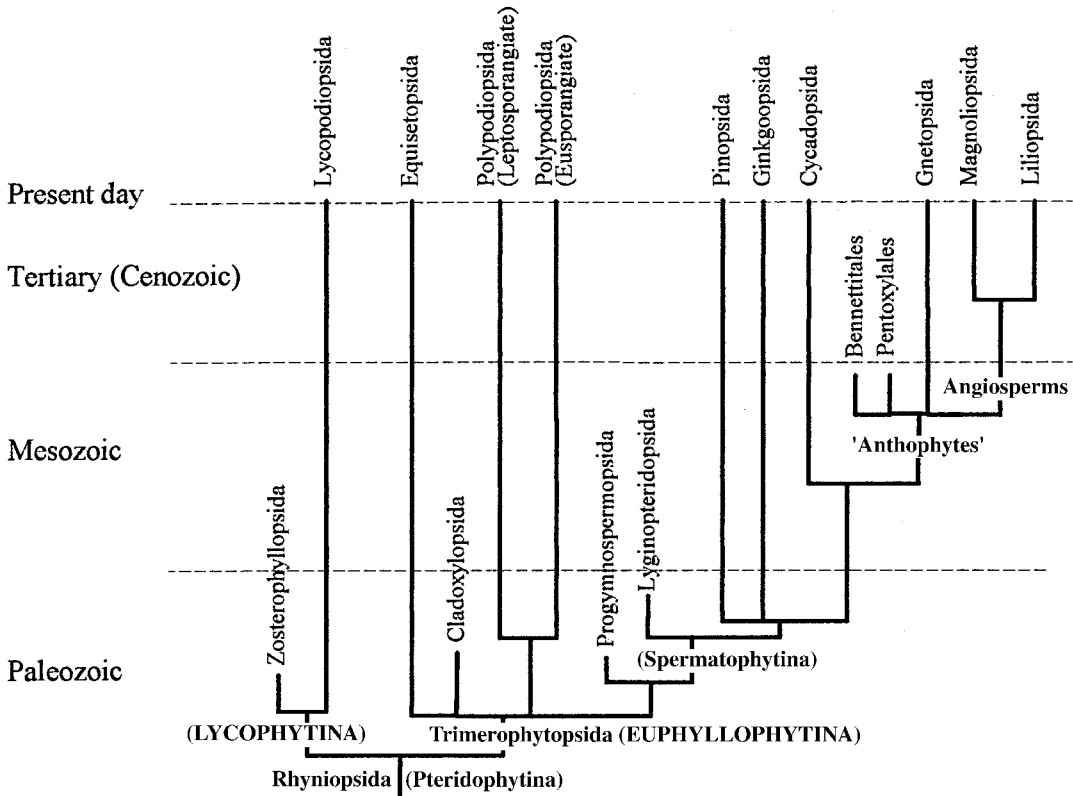

Figure 6.5 A phylogeny of the major groups of tracheophytes and their taxonomic hierarchy. Based on Table 6.1.

Tracheophytes with lateral sporangia (Lycophytina)

The early vascular plants also included forms in which the sporangia were borne laterally. They are placed in the separate classes Zosterophylloids and Lycopodiopsida.

Zosterophylloids

Zosterophyllum (Fig. 6.7a) is known from the lowermost Devonian in several localities in Europe. It appears to have a tufted habit, with the branches diverging at wide angles ("H-shaped" branching), the whole reaching a height of about 15 cm (6 in.). The xylem was exarch, and often elliptical in section. It consisted of distinctive tracheids. In *Zosterophyllum* the sporangia were clustered toward the ends of the aerial branches, and

dehisced along the distal convex surface. Also placed in the Zosterophylloids is *Sawdonia* (Fig. 6.7b), found at a number of levels in the early Devonian. This had a creeping rhizome from which aerial branches, showing a monopodial tendency, rose to a height of about 30 cm (12 in.). The aerial axes were clad with tapering spines, and the ultimate branches were circinately coiled at the tips. Stomata were present in the epidermis, and within the axes ascended a solid core of tracheids with reticulate thickening. The sporangia were borne laterally in loose spikes toward the ends of the branches. *Deheubarthia*, widespread in the Lower Devonian of South Wales, was similar to *Sawdonia*. *Barinophyton* (Fig. 6.8) and *Protobarinophyton*, of Upper Devonian age, are problematic, but are similar to zosterophylloids in general morphology and anatomy. These plants bore sporangia in two ranks on upright stems. The sporangia were unusual in producing spores of two distinct sizes, and these plants have accordingly figured in discussions of the origin of heterospory (Table 1.1).

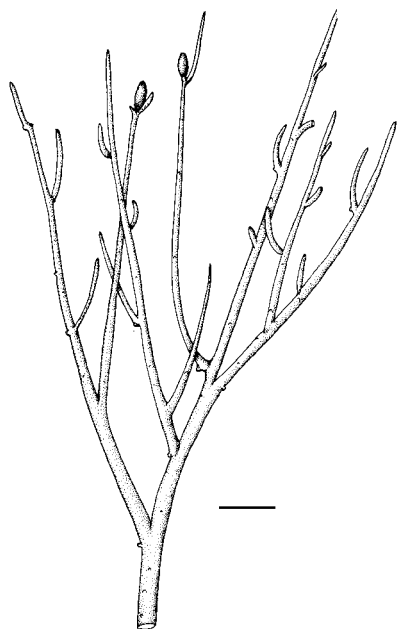

Figure 6.6 Reconstruction of *Rhynia gwynne-vaughanii*. Scale bar 1 cm. (From Stewart and Rothwell. 1993. *Paleobotany and the Evolution of Plants*, 2nd edn. Cambridge University Press, New York.)

Lycopodiopsida

The class Lycopodiopsida contains both living and fossil plants. It represents one of the most complete records of plant evolution currently known, extending from the Lower Devonian to the present day. The characteristics of the division can be summarized as follows:

Sporophyte consisting of more or less dichotomously branching axes, but differentiated into root and shoot. Shoot bearing microphylls, each containing a single vein, but leaf trace leaving no gap in the stele. Vascular tissue consisting of tracheids and phloem. Sporangia in or near axils of microphylls, sporophytes often aggregated into cones (strobili), homo- or heterosporous.

Gametophyte (in living forms) terrestrial or subterranean. Spermatozoids flagellate. Embryogeny endoscopic.

Six orders are recognized within the Lycopodiopsida, three containing the living species and their undoubted fossil relatives, and three wholly fossil. The living lycopodiopsids are a minor component of contemporary vegetation. The fossil record, however, shows that the lycopod-

iopsids were abundant in the Carboniferous period, many then being represented by substantial trees. Only herbaceous forms have persisted until the present day.

The early Lycopodiopsida

The Drepanophycales

The Drepanophycales are represented by the remarkable *Baragwanathia* from upper Silurian or Lower Devonian rocks of Australia and China. The terminal dichotomizing axes of this distinctive plant reached a diameter of 1–2 cm (0.4–0.8 in.), the basal axes probably being more massive. They bore needle-like leaves, arranged in a dense spiral and reaching up to 4 cm (1.6 in.) in length (Fig. 6.9). The stem contained a stellate stele, from which slender strands ascended into the leaves. Some of the shoots had fertile regions in which reniform sporangia, containing cutinized spores, lay amongst the leaves. Although the precise attachment of the sporangia is still unknown, the general resemblance of *Baragwanathia* to a lycopod is so striking that an affinity seems undoubted.

Asteroxylon (Fig. 6.10), a plant from the Lower Devonian Rhynie Chert, is better represented. The branching was monopodial with dichotomizing lateral branches, the whole probably reaching a height of approximately 50 cm (20 in.). The aerial axes bore spine-like enations about 5 mm (0.2 in.) long, lacking a vascular strand but furnished with stomata. The sporangia were reniform and terminated distinct stalks arising between the enations toward the tips of the branches. The stem in section shows a stellate stele (actinostele) with mesarch xylem. The cortex displayed at least three zones, the middle consisting of plates of cells separated by large air spaces. Vascular strands traversed the cortex. They entered the stalks of the sporangia but stopped short of the enations. The anatomy suggests that *Asteroxylon* was a marsh plant.

The Protolepidodendrales

The Protolepidodendrales are distinguished by their microphylls branching at the tips. In *Leclercqia* (Fig. 6.11) from the Middle Devonian, the leaf forked several times. This plant is particularly noteworthy since a ligule (p. 114) was clearly present. The sporangia were attached to the

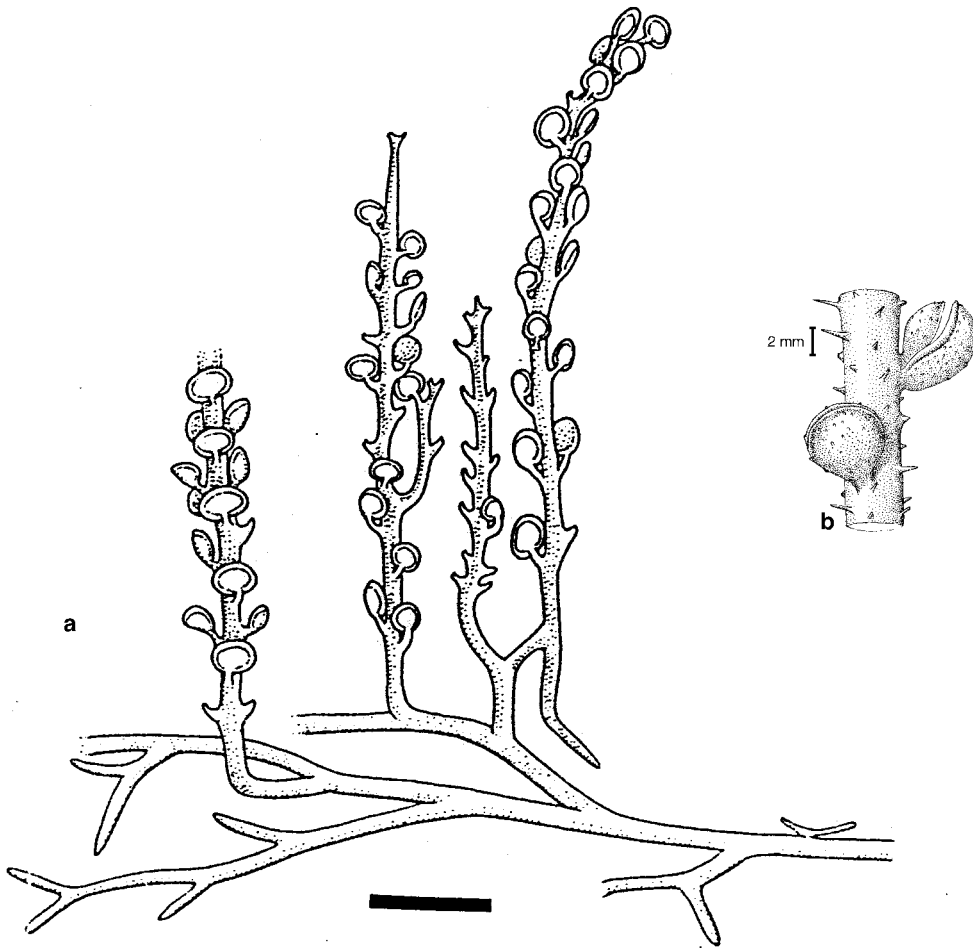

Figure 6.7 Zosterophylls. (a) Habit of *Zosterophyllum*. Scale bar 5 mm. (b) Sporangia of *Sawdonia* showing transverse dehiscence. ((a) from Kenrick and Crane, 1997. *The Origin and Early Diversification of Land Plants*. Smithsonian Institution, Washington, DC; (b) after Gensel, from Stewart, 1983. *Paleobotany and the Evolution of Plants*. Cambridge University Press, New York.)

adaxial surface of the microphyll close to its insertion. The habit of these plants, which probably thrived in the warm, humid climate of the early Devonian, seems to have been similar to that of the worldwide *Lycopodium clavatum*. They were also probably homosporous. In the herbaceous lycopodiopsids, living and fossil, there is a correlation between exarch xylem and the lateral position of the sporangia, contrasting with the endarch xylem and terminal sporangia of the rhyniopsids.

Carboniferous rocks yield an abundance of

lycopodiopsid fossils, of both vegetative and reproductive structures, and isolated spores. Of the many forms present, some were evidently herbaceous. Those having a general resemblance to living *Lycopodium* are placed in *Lycopodites*, but others, in which heterospory has been demonstrated, are believed to have been more like *Selaginella* and are placed in *Selaginellites*. In each instance, however, the attribution is less certain than with Mesozoic forms.

The Lepidodendrales

The most impressive Lycopodiopsida of the Carboniferous, however, were undoubtedly the arborescent Lepidodendrales, some of which achieved a height of 30 m (98 ft). *Lepidodendron* (*Paralycopodites*, *Diaphorodendron*) (Fig. 6.12b), for example, consisted of a trunk, 1 m (39 in.) or more in diameter at its base, which rose as a single

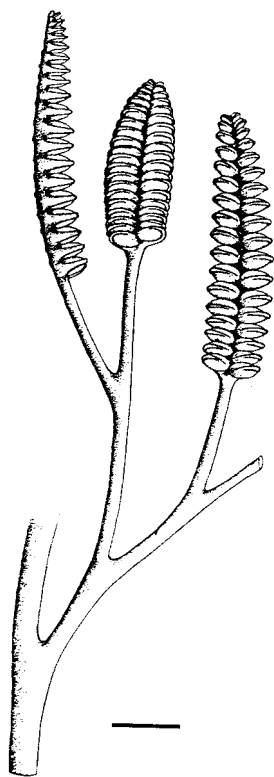

Figure 6.8 *Barinophyton*. Terminal branches bearing sporangia in two ranks. Scale bar 1 cm. (From Kenrick and Crane. 1997. *The Origin and Early Diversification of Land Plants*. Smithsonian Institution, Washington, DC.)

column until it broke up by numerous dichotomies into the dense crown of branchlets. The upper parts of the tree bore simple ligulate microphylls, up to 20 cm (8 in.) long, triangular in cross-section, and arranged in regular spirals. The trunk and lower branches of *Lepidodendron* and its relatives retained a characteristic pattern of diamond-shaped leaf cushions (Fig. 6.13). In the upper part of each is a pit which indicates the site of the ligule, and at the center a scar showing where the leaf was attached. Within the scar the emerging vascular bundle can be discerned, and two small depressed areas, one on each side of the bundle. These are the remains of strands of aerenchyma (parichnos) which ran from the cortex of the stem to the leaf. The uniformity of the leaf scar suggests a distinct abscission mechanism. The trunk was anchored at ground level by four radiating arms which, since they were first found

detached and not immediately recognized, were named *Stigmaria*. The stigmarian axes dichotomized freely and the smaller bore rootlets, anatomically similar to those of *Isoetes* (p. 160), in spiral sequence.

Despite the girth of *Lepidodendron*, the anatomy of the trunk was comparatively simple, and its manner of growth consequently puzzling. The primary vascular tissue is often well preserved, and even sieve cells have been seen in sufficient detail to reveal a close resemblance to those of *Lycopodium*. An exarch protosteles was present at the base of the trunk, but above it became solenostele (see Fig. 7.28). A vascular cambium evidently arose at an early stage, but above it added only a narrow zone of secondary xylem to the primary. The formation of secondary phloem is doubtful. Additional secondary activity occurred in the outer cortex, resulting in a hard sclerotic periderm which undoubtedly provided the principal mechanical support to the trunk. The inner cortex contained elongated cells, a so-called “secretory tissue”, which may have been a primitive form of phloem. The central zone of cortex, usually fragmentary or missing in the fossilized material, probably consisted of thin-walled aerenchyma, continuous with that in the stigmarian axes and leaves. The curious anatomy, particularly the small amount of secondary xylem, has led to the view that the growth of these trees did not continue indefinitely, but was determinate. It is envisaged that the plant first generated a massive apical meristem (Fig. 6.12a), the activity of which then produced an axis of considerable height before dichotomy began. At each dichotomy the apices became smaller, until eventually the axes either terminated in a cone, or their apices merely ceased to be active.

Sigillaria (Fig. 6.12c) was also prominent in the forests of the Upper Carboniferous. Although similar to *Lepidodendron* in its general features it was conspicuous for its long, grass-like leaves, sometimes reaching 1 m (39 in.) in length. *Sigillaria* further differed in the production of whorls of cones borne axially amongst the leaves, instead of terminally on distal branches, as in *Lepidodendron*. *Chaloneria* is an Upper Carboniferous lycophyte with a strikingly different form. The main axis, about 2 m (6.5 ft) tall, was

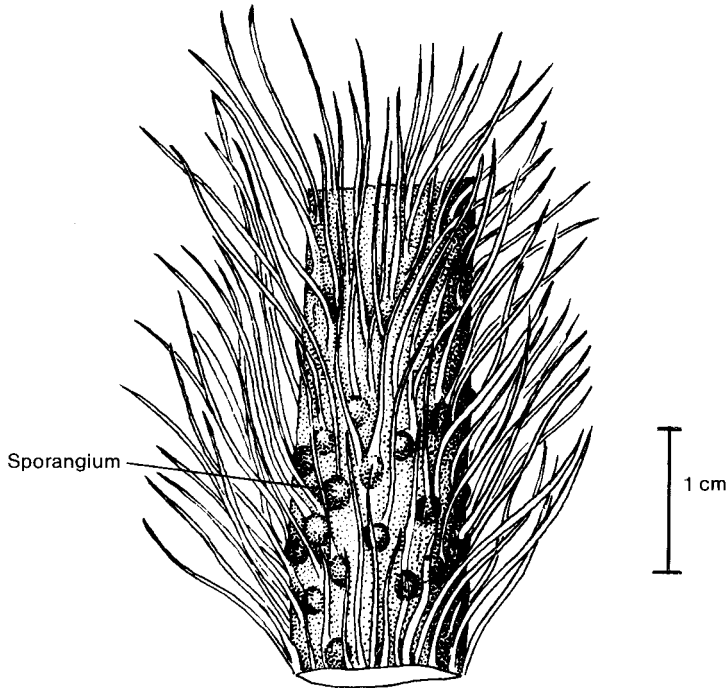

Figure 6.9 *Baragwanathia*. Shoot bearing sporangia. (After Lang and Cookson, from Stewart. 1983. *Paleobotany and the Evolution of Plants*. Cambridge University Press, New York.)

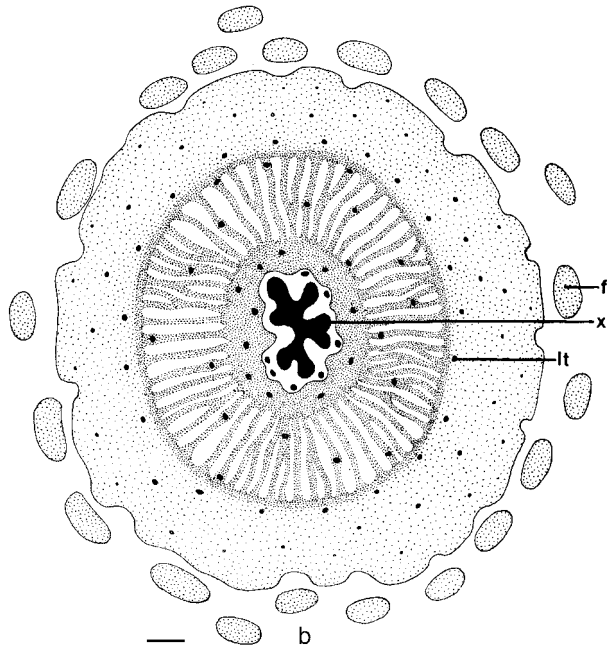
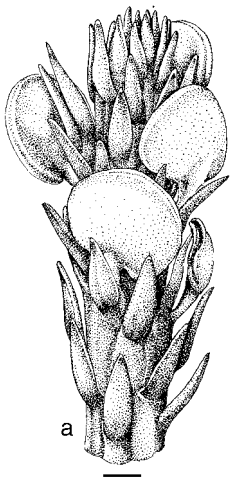

Figure 6.10 *Asteroxylon*. (a) Reconstruction of fertile axis with lateral sporangia. Scale bar 1 cm. (b) Section of stem with lobed xylem (x), leaf traces (lt), and foliar units (f). Scale bar 2 mm. (From Stewart and Rothwell. 1993. *Paleobotany and the Evolution of Plants*, 2nd edn. Cambridge University Press, New York.)

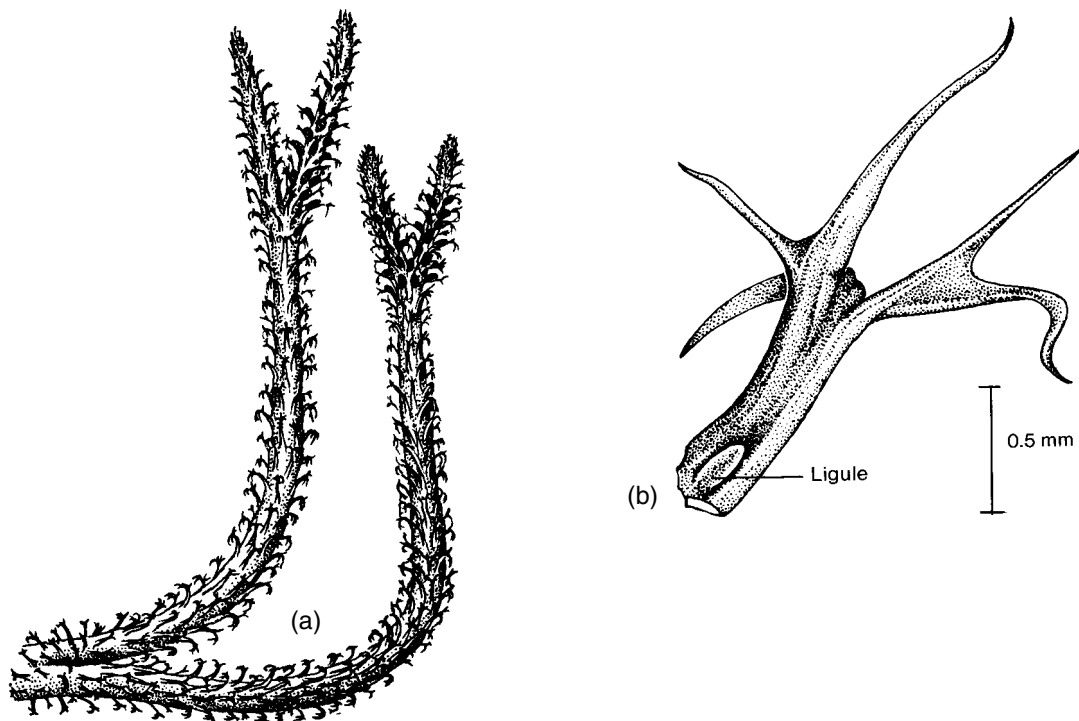

Figure 6.11 (a) Reconstruction of *Leclercqia complexa* with sterile and fertile leaves. Scale bar 1 cm. (b) *Leclercqia* leaf showing ligule. (After Grierson and Bonamo, from Stewart and Rothwell, 1993. *Paleobotany and the Evolution of Plants*, 2nd edn. Cambridge University Press, New York.)

wholly unbranched. Although about 10 cm (4 in.) in diameter and with conspicuous secondary thickening below, the stem tapered with progressive reduction in the amount of secondary thickening to a slender apex. The narrow microphylls were ligulate, about 1 cm (0.4 in.) long, and borne in spiral sequence. Roots were produced from a swollen rounded base. Some consider *Chaloneria* to be an early representative of the Isoetales. The recent discovery of *Clevelandodendron* in the Cleveland Shale indicates that slender unbranched lycopodiopsids of isoetalean form may have originated as early as the late Devonian.

REPRODUCTION

In most *Lepidodendrales* the strobili, varying from 1 to 3.5 cm (0.4 to 1.4 in.) in width and 5 to 40 cm (2 to 16 in.) in length, were terminal on the branchlets. A few homosporous cones are known, but most, even some of the earliest (e.g.,

Cyclostigma from the Upper Devonian), were heterosporous, resembling the cones of *Selaginella* in general features and the placement of the sporangia in relation to the ligule. In *Chaloneria* the fertile regions were either confined to the tip of the axis, or in some forms fertile and sterile regions alternated in the upper part of the stem.

Although generally the sporangia of the *Lepidodendrales* were borne in a manner similar to those of *Selaginella*, there are forms in which the wings of the sporophyll were inflexed, the margins coming tightly together above the megasporangium. Representative of this kind of development is *Lepidocarpon* (Fig. 6.14). An even more elaborate form is *Miadesmia*, also from the Upper Carboniferous, which showed a distinct micropyle-like opening, surrounded by hairs, at the distal end of the enclosing megasporophyll. There were also lateral membranous outgrowths which may have assisted dispersal of the entire reproductive structure. Since *Miadesmia* reached a length of only about 3 mm (0.12 in.), it may have been borne by a herbaceous lycopodiopsid. In both *Lepidocarpon* and *Miadesmia* the mature megasporangium contained only one functional megaspore. The complexity of the apparatus

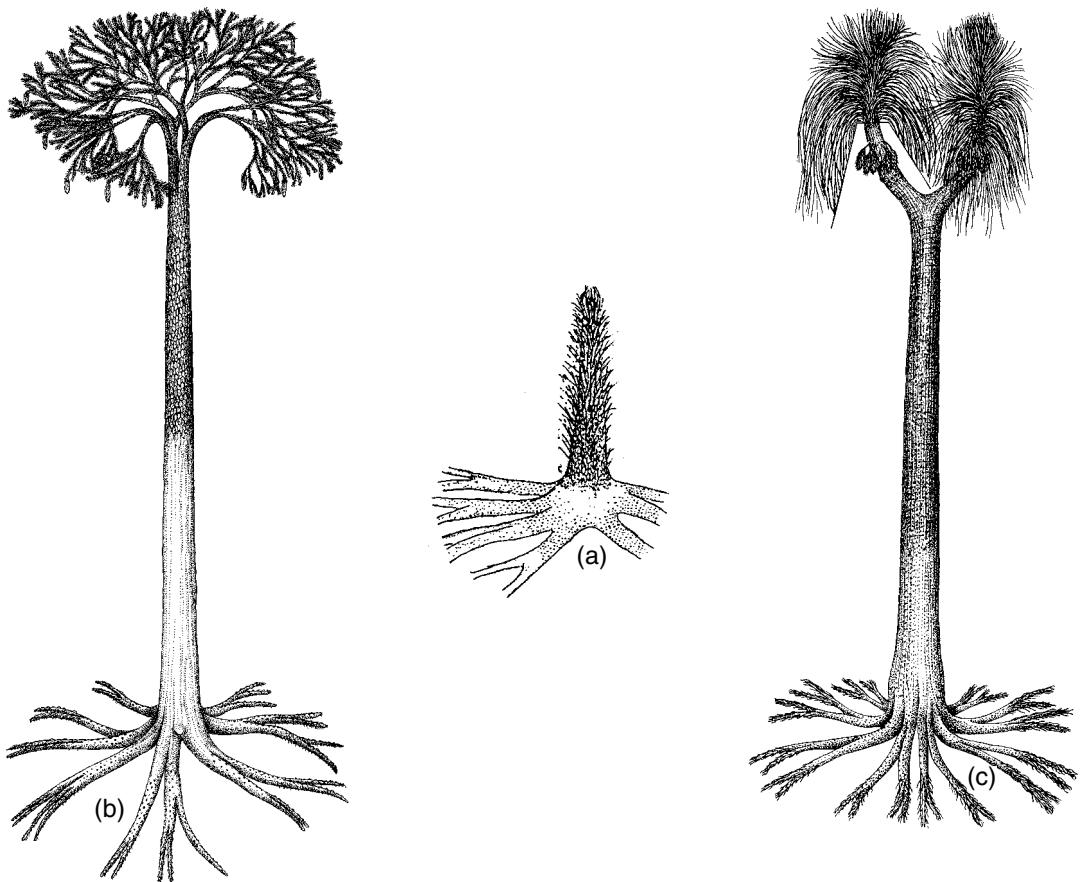

Figure 6.12 Tree-like lycopodiopsids. (a) A suggested juvenile form a few meters in height. (b, c) Reconstructions of (b) *Lepidodendron* and (c) *Sigillaria*, both of which grew to between 30 and 50 m in height. ((a) from Phillips and DiMichele. 1992. *Annals of the Missouri Botanical Garden* 79; (b), (c) after Hirmer (1927) from Stewart and Rothwell. 1993. *Paleobotany and the Evolution of Plants*, 2nd edn. Cambridge University Press, New York.)

surrounding the megasporangia of *Lepidocarpon* and *Miadesmia* has been interpreted as a trend toward an ovule-like formation. *Lepidocarpon* seems to have been borne by *Lepidophloios*, a tree reaching some 20 m (70 ft) in height, the shoots with characteristically broad leaf scars. The male cone *Lepidostrobus* was also probably borne by *Lepidophloios*. It is possible that *Lepidophloios* was dioecious, providing an early example of sex expression segregated in this manner in the sporophytic phase.

Germinating megaspores and microspores are

encountered in petrified material. Megagametophytes were wholly or partly endosporic, the exposed portion often bearing rhizoids at its margin and archegonia in the central cushion. Possible mitotic figures have been seen in germinating microspores. Undifferentiated embryos are known in gametophytes as old as the Lower Carboniferous. In all essential respects the reproduction of the free-sporing *Lepidodendrales* resembled that of *Selaginella* and *Isoetes* (pp. 156, 160). In *Lepidocarpon* germination of the single megaspore was certainly *in situ*, leading to rupture of the sporangial wall. Some specimens of *Lepidocarpon* have yielded remarkable examples of differentiated embryos lying within the gametophyte, the whole enclosed within the megasporophyll. It would be difficult to deny such structures the status of seeds. When detached they may have floated, and provided a means of distribution of the plant in the Carboniferous swamps.

Although the *Lepidodendrales* appear to have

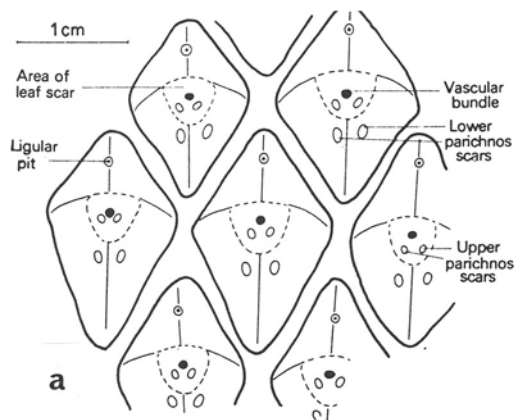

Figure 6.13 *Lepidodendron*. (a) Surface of cast of stem showing leaf cushions and scars. The thin-walled tissue of the parichnos strands has collapsed in the leaf cushions, producing the depressions referred to as secondary (lower) parichnos strands below the leaf scar. (b) Shoots of *Lepidodendron* showing leaves and exposed leaf cushions. Scale bar 1 cm.

died out at the end of the Paleozoic, a few similar forms, possibly of isoetalean affinity, have been found in Mesozoic rocks. *Pleuromeia* (Fig. 6.15), for example, known from Triassic sandstones, is suggestive of an intermediate between the *Lepidodendrales* and the *Isoetales*. A single trunk, little more than 1 m (39 in.) high, with spirally arranged leaf scars, rose from a rounded or lobed base which produced roots in the same manner as *Stigmarians* axes. It terminated above in a crown of narrow ligulate leaves, and, when fertile, a single erect cone with curious obtuse sporophylls. *Pleuromeia* was heterosporous and may occasionally have been dioecious. Ecologically it seems to

have been maritime, some species possibly forming coastal thickets.

The living lycopodiopsids

Origin

It is clear that the living lycopodiopsids are relicts of a component of the plant kingdom which reached the peak of its morphological complexity and floristic success in the Paleozoic, about 200 million years ago. Although this period was marked by the spectacular *Lepidodendrales*, it seems very likely that herbaceous forms also existed throughout the evolution of the class and that they closely resembled those living today. Many of the living homosporous lycopodiopsids have high chromosome numbers (reaching $2n=134$ in some species), indicating that they may be ancient allopolyploids behaving cytologically as diploids. Nevertheless, isozyme analysis shows no evidence of heterogeneity normally

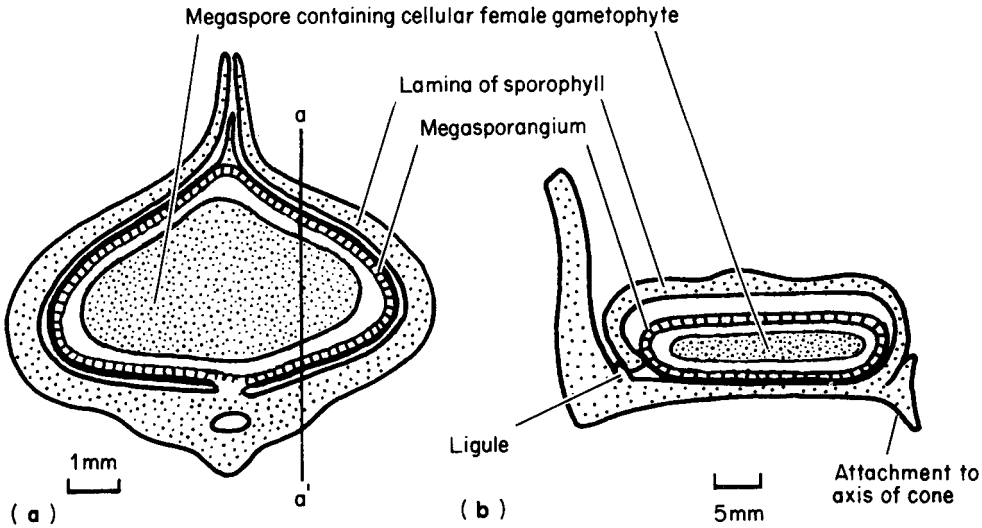

Figure 6.14 *Lepidocarpon*. (a) Transverse section showing megasporangium enclosed in folded sporophyll. (b) Vertical section of region indicated by a-a' in (a). ((a) after Arnold. 1947. *An Introduction to Paleobotany*. McGraw-Hill, New York; (b) after Hoskins and Cross, from Arnold. 1947. *An Introduction to Paleobotany*. McGraw-Hill, New York.)

associated with species of known allopolyploid origin. Hybridization may therefore have played little part in their evolution.

Besides the antiquity of the lycopodiopsid kind of construction, the fossil record also indicates that the Lycopodiopsida always had a distinctly heteromorphic life cycle. As in the living representatives, there is a conspicuous absence of morphological and anatomical similarities between the sporophytic and gametophytic phases. The gametophytes appear never to have been other than parenchymatous plants of lowly status, and indications of possible ancestral less heteromorphic cycles are wholly lacking. The reduction of the gametophytes in the heterosporous Lycopodiopsida to little more than endosporic thalli can be regarded as a major step in the direction of becoming independent of humid conditions for the survival of this vulnerable phase. Had the lycopodiopsids acquired this valuable adaptation to terrestrial life earlier and proceeded from *Lepidocarpon* to the evolution of fully integumented seeds, their spectacular decline at the end of the Paleozoic might never have occurred.

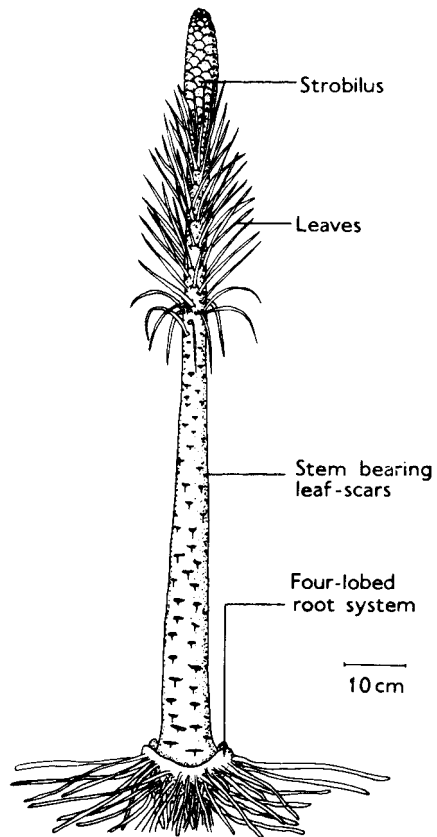

Figure 6.15 *Pleuromeia sternbergi*, reconstruction. (After Hirmer, from Andrews. 1961. *Studies in Paleobotany*. Wiley, New York.)

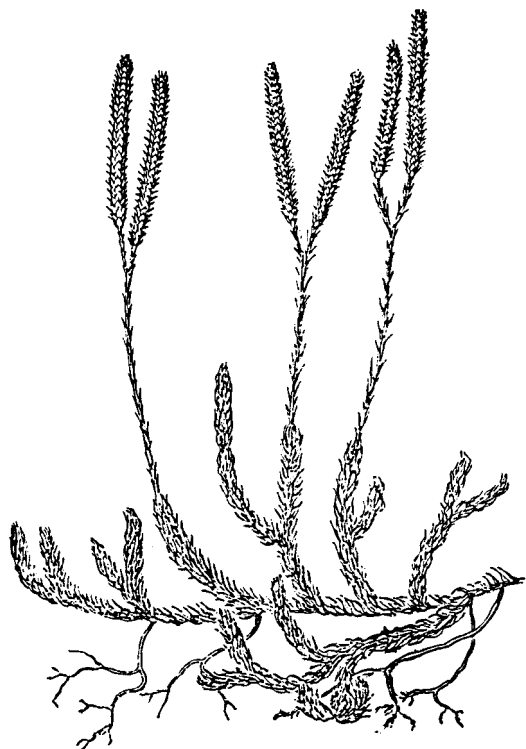

Figure 6.16 *Lycopodium clavatum*, habit. Scale bar 1 cm.

The Lycopodiales

Members of the order Lycopodiales, which includes the genera *Lycopodium* (club mosses) and the Australasian *Phylloglossum*, are distinguished by their eligulate leaves and homospority.

Lycopodium (Fig. 6.16), with about 200 species, is distributed throughout the world from arctic to tropical regions, with a related range in the growth form of the sporophyte. The colder climates favor species with short, erect stems, or creeping stems giving rise to short upright side branches, while those in the tropics have much laxer growth, are sometimes stoloniferous, and are often epiphytes. Taxonomists are now inclined to assign species of *Lycopodium* to a number of smaller genera. For present purposes, however, the concept of *Lycopodium* will be retained, and alternative nomenclature will be indicated where appropriate.

The stem is surrounded by microphylls, a form of leaf which is typically small, simple in outline, and with a single median vascular strand. Some

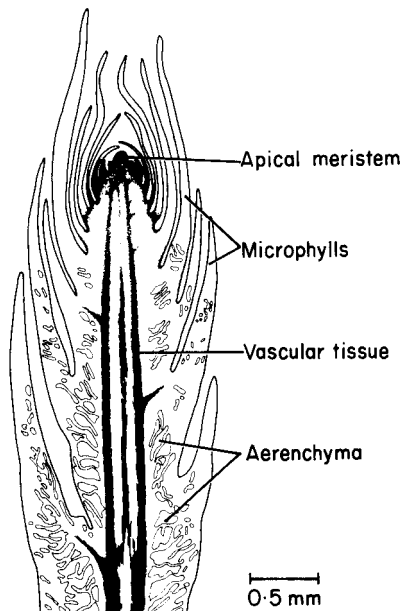

Figure 6.17 *Lycopodium (Diphasiastrum) alpinum*. Longitudinal section of apical region of vegetative shoot.

species of *Lycopodium*, especially the epiphytic ones, are heterophyllous, the lateral rows of leaves being expanded in the plane of the shoot system and the upper and lower rows adpressed and smaller. The fertile leaves (sporophylls) may be similar to the sterile, as in *L. (Huperzia) selago*, and the fertile regions not clearly set off from the sterile along the axis. More usually, however, the sporophylls differ from the sterile leaves in size, shape and the extent of the chlorophyllous tissue, and are often grouped together, as in *L. clavatum*, in distinct cones (strobili) of determinate growth.

Roots arise endogenously, emerging from the underside of the stem in the prostrate species, or from near the base of the stem in upright species. In some of the latter, initiation of the roots occurs near the shoot apex, but instead of emerging there the roots grow down inside the cortex, and break out only when they reach the level of the soil.

The stem, which grows from a group of initial cells (Fig. 6.17), contains a central stele. Although basically a protostele, the detailed anatomy shows considerable variation with species. In its simplest form the stele consists of a core of tracheids, more or less stellate in section, with phloem lying

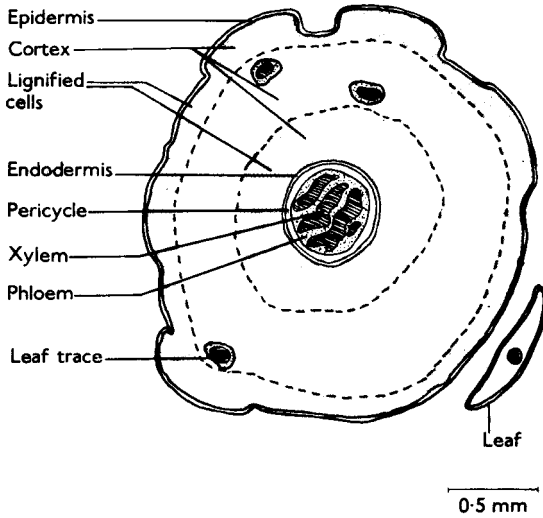

Figure 6.18 *Lycopodium clavatum*. Transverse section of stem.

between the arms. In other species, the xylem and phloem form parallel bands (Fig. 6.18) (plectostele), or the phloem and xylem may be intermingled, anastomosing strands of sieve cells being scattered amongst the tracheids. In every instance differentiation of the xylem begins at the exterior and then proceeds centripetally, leaving no undifferentiated tissue at the center. The xylem is thus uniformly exarch. Detailed studies of the wall of the tracheids of *L. (Huperzia) lucidulum* have revealed that the spiral thickenings are coated with a layer of material (lignin) resistant to polysaccharide hydrolases, which continues, perforated by irregularly shaped holes ranging in diameter from less than $1\mu\text{m}$ to about $4\mu\text{m}$, between the thickenings. Beneath this, and adjacent to the primary cell wall, another layer can be distinguished, referred to as the “template layer”, which is not resistant to enzyme digestion. This structure is very similar to that of the tracheid walls of early Lycophytina, the degradable layer being replaced in fossil material by clear matrix.

The sieve cells of the phloem are elongated with steeply inclined end walls. The cell contents are partly degenerate, but associated parenchyma cells have well-structured protoplasts. The sieve plates occur on both the lateral and tapering end walls. The regular presence of callose has not been confirmed. The vascular tissue, entirely primary,

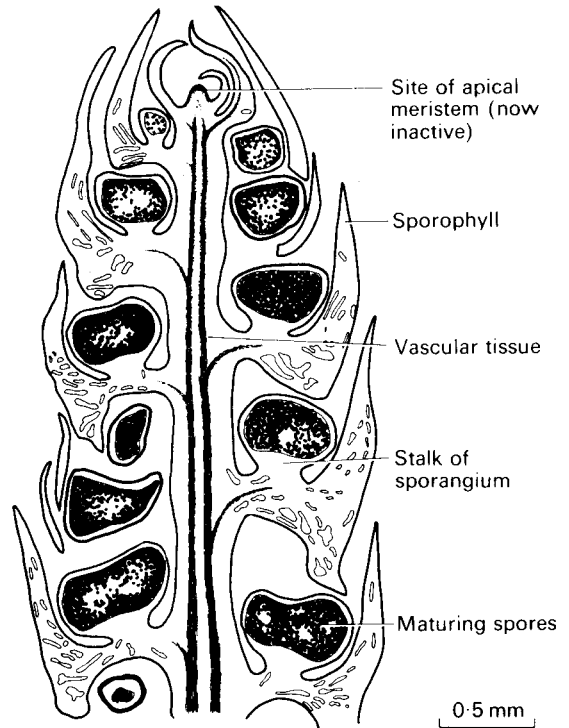

Figure 6.19 *Lycopodium clavatum*. Longitudinal section of upper region of young strobilus.

is usually surrounded by a narrow zone of parenchyma, and this in turn by an endodermis, the cells of which have a distinct Casparian strip (see p. 185).

The leaves, the chief site of photosynthesis, are structurally simple. There are abundant stomata on both surfaces, and internally numerous intercellular spaces. There is, however, no clearly differentiated mesophyll.

REPRODUCTION

Sporangia, borne singly in the axil of a sporophyll or close to its insertion (Fig. 6.19) (and considered by some to be cauline in origin), develop from a group of initial cells, and are hence termed *eusporangiate*. Continued cell division within the primordium leads to a central mass of spore mother cells surrounded by a wall several cells thick. The inner layers of the wall function as a tapetum, breaking down to provide materials which contribute to the development and maturation of the spores. Following meiosis the four young spores

Figure 6.20 *Lycopodium volubile*.

(a) Vertical section of subterranean gametophyte. (b) Mature archegonium.

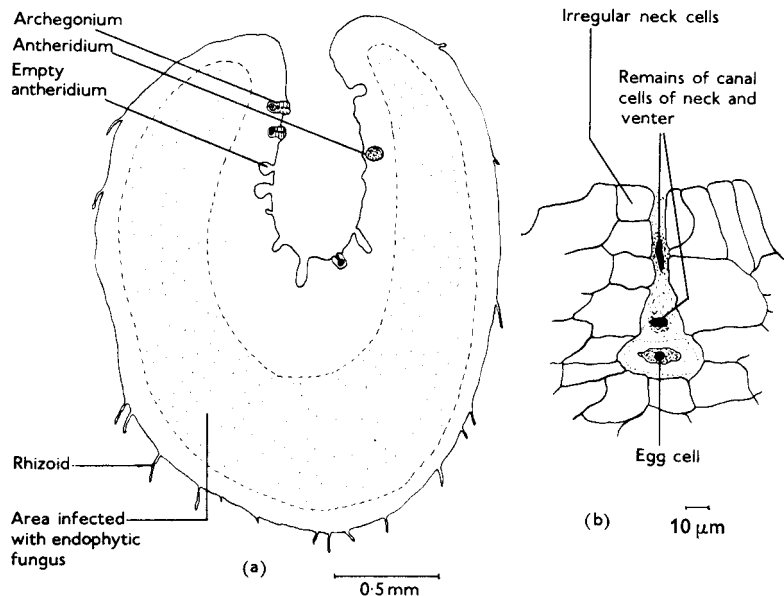

arrange themselves in a tetrahedral fashion so that each spore has three triangular faces at its proximal pole where it is in contact with its fellows (Fig. 6.31). As the spores separate these areas become less thickened than elsewhere, and the edges between them conspicuous, often appearing as a prominent triradiate scar in the mature spore (*trilete* spores). The sporangia dehisce transversely along a line of thin-walled cells (*stomium*) and the minute spores (each about 50 μm in diameter) are distributed by wind.

In some species of *Lycopodium* the exine of the spore has quite elaborate reticulate ornamentation, while in others it is almost smooth. The rough oily spores are not easily wetted and their germination may be delayed for several years, probably until weathering and attrition have rendered the coat permeable. The process may be simulated in the laboratory by immersing such spores in concentrated sulfuric acid. Following this treatment the spores germinate freely in pure culture. In natural conditions initially unwettable spores may be washed deep into the soil before germination occurs, and this is reflected in the nature of the gametophyte. For example, in *Lycopodium clavatum*, the spores of which have a pronounced reticulate relief, the gametophyte is a subterranean saucer-shaped structure, growing saprophytically and persisting for several seasons. The sex organs are produced on a cushion in the central region. *Lycopodium volubile* has a similar spore and gametophyte (Fig. 6.20). In the tropical *Lycopodium* (*Lycopodiella*) *cernuum*, where the spores are smooth, germination and development occur rapidly, producing lobed, cup-shaped gametophytes which possess chlorophyll and last for little more than a single season. In *L. (Huperzia) selago*, in which the spores are somewhat intermediate in

the development of the wall, there is a corresponding ambivalence in the habitat of the gametophyte. In all instances the gametophyte of this species is a small, carrot-shaped body growing saprophytically and producing sex organs on the upper cushion. It may, however, be either buried or at the surface, and if the latter the upper part becomes pale green. There is thus a general relationship between the nature of the spore wall and the form and duration of the gametophytic plant. The gametophytes of many species, including all those whose gametophytes are subterranean, are invested with a mycorrhizal fungus. Provided the medium is appropriate, such gametophytes can nevertheless be grown in axenic culture.

The sex organs of *Lycopodium* arise from superficial cells of the gametophyte, and both the male and female gametangia are enclosed to a great extent by vegetative tissue (Fig. 6.20), although the archegonia have relatively conspicuous necks. The spermatozoids are biflagellate, about 8–10 μm long, and spindle-shaped (Fig. 6.21). The ultrastructure is basically similar to that of bryophyte spermatozoids, but the nucleus is less elongated and is not coiled. Fertilization is probably facilitated by chemotactic attraction of spermatozoids to archegonia. The zygote divides by a wall transverse to the axis of the archegonium. The outer cell, termed the *suspensor*, divides no further, but the inner remains meristematic and

gives rise to two regions of cells. The central region becomes the foot, while the inner differentiates into the root, first leaf, and stem apex of the embryo proper. This development results in the embryo being directed inwards, and the embryogeny is consequently said to be endoscopic.

At first the apex of the embryo points downward, but expansion of the foot region pushes it to one side and the young sporophyte finally breaks out of the surface of the gametophyte. Before it becomes fully established, the young plant depends upon food materials absorbed from the gametophyte, probably through the foot. In some species of *Lycopodium* (e.g., *L. (Lycopodiella) cernuum*) the differentiation of the embryo is delayed and it emerges as a parenchymatous protuberance, termed a protocorm. This eventually gives rise to one or more growing points, each of which yields a normal plant. Apogamy has been observed in *L. cernuum* in culture, but is not known in nature. *L. (Huperzia) selago* commonly produces bud-like gemmae in the axils of the upper leaves.

Phylloglossum, confined to Australasia, is the only other living genus of the Lycopodiales. Its single species, *P. drummondii*, consists of an upright sporophyte, reaching 5 cm (2 in.) or less, with a basal whorl of leaves and a pedunculate strobilus (Fig. 6.22). During growth a lateral axis arises near the base of the plant and extends down into the soil, its tip eventually becoming transformed into a tuber. This tuber forms an organ of perennation, persisting through the dry period (when the remainder of the plant perishes) and giving rise to the following year's growth. The gametophyte of *Phylloglossum* is similar to that of *Lycopodium (Lycopodiella) cernuum*, but the spermatozoid, although of a shape similar to that of *L. cernuum*, is furnished with about 20 apical flagella. Although *Phylloglossum* is strikingly different from *Lycopodium* in habit, there is clearly a close similarity in basic features of anatomy and reproduction (there is an interesting analogy, for example, between the protocorm stage in the development of the sporophyte of *L. cernuum* and the perennating tuber of *Phylloglossum*). *Phylloglossum* is probably a form that has become specialized in relation to a particular kind of habitat. Nevertheless, significant differences from *Lycopodium* in the differentiation of the motile

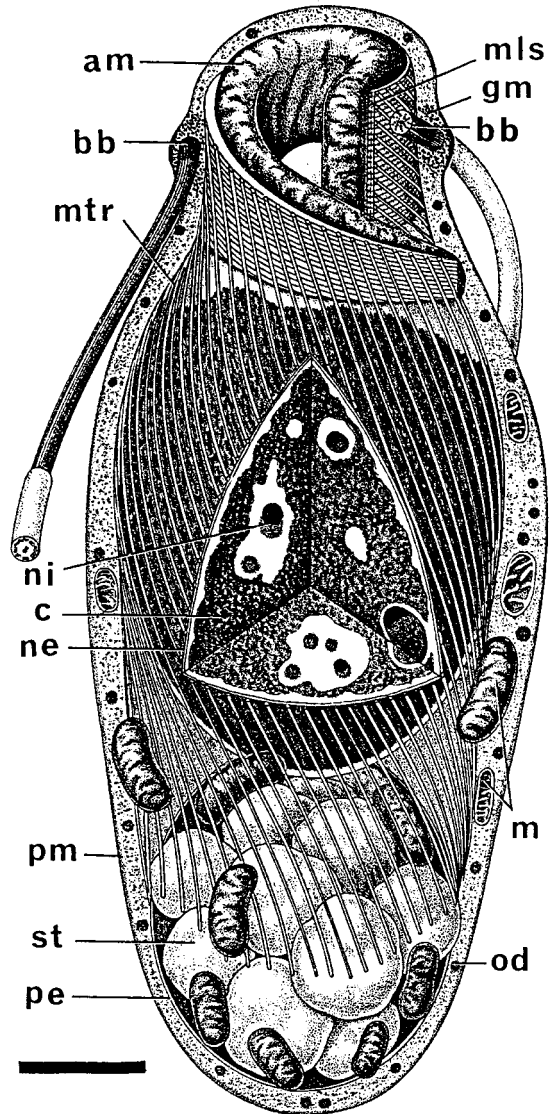

Figure 6.21 *Lycopodium (Lycopodiella) cernuum*.

Diagrammatic reconstruction of the mature spermatozoid, depicted with a wedge of the nucleus removed. About every third microtubule of the microtubular ribbon (mtr) (spline) and about every third lamella of the multilayered structure (mls) are portrayed. am, large coiled anterior mitochondrion; m, mitochondrion; od, osmiophilic droplet; st, starch within the single plastid (amyloplast); pe, plastid envelope; bb, basal body; gm, globular matrix (cytoplasm); ne, nuclear envelope; ni, nuclear inclusion; c, chromatin; pm, plasmalemma. Scale bar 1 μ m. (From Robbins and Carothers. 1978. *American Journal of Botany* 65.)

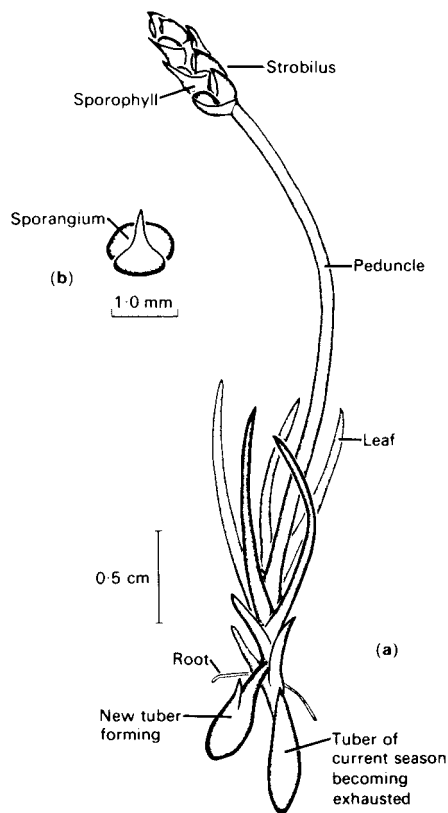

Figure 6.22 *Phylloglossum drummondii*. (a) Habit. (b) Sporophyll and sporangium.

apparatus of the male gamete, and in the number of flagella, probably indicate a long period of separate evolution.

The Selaginellales

The habit of the order Selaginellales resembles that of the Lycopodiales, but the microphylls are ligulate, the sporophylls are always aggregated into distinct strobili, and the spores are of two kinds (produced in separate sporangia), differing in size and in the sexes of the gametes they eventually produce.

There are more than 700 species of *Selaginella*, most of which are tropical, ranging from small epiphytes to large climbing plants. A few species of arid areas are capable of flexing their branches and, in a rolled-up form, resisting prolonged desiccation (e.g., *S. lepidophylla*). The basic cell structure and enzymes are conserved in the dehydrated cells. Normal form and metabolism are rapidly

resumed on moistening ("resurrection plants"). The stems are commonly much more branched than in *Lycopodium*. In scandent species the branching of the laterals often takes place in a single plane. Leaves originate in a spiral sequence, but the arrangement may be modified during subsequent development. In *S. selaginoides* the leaves are all similar (isophylly) and remain radially arranged. Many species, however, display anisophylly (heterophylly). The two lower rows of leaves are then expanded laterally, the two upper remaining smaller and appressed (Fig. 6.23a). In scandent species the anisophylly is frequently confined to the lateral branches, enhancing the frond-like appearance of the whole spray.

In young plants (Fig. 6.23b) roots are initially produced from the base of the stem. Although in a few species roots continue to be produced from a tuberous stem base, in others later roots emerge principally from leafless rhizophores (Fig. 6.23b). These originate from the stem at points of branching and grow down toward the soil, dichotomizing as they approach its surface. Contact apparently acts as a stimulus, causing roots to arise endogenously and penetrate the substratum.

Structurally the leaves of *Selaginella* resemble those of *Lycopodium*, but in a few species (such as the Mexican *S. schaffneri*), instead of a single vein, a number of veins radiate from the insertion and branch dichotomously at their tips. In some tropical species (e.g., *S. wildenowii*) leaves shaded by other foliage develop a striking blue sheen (iridescence). This depends upon the presence of two superimposed layers of polysaccharide in the outer walls of the upper epidermis. These act as an interference filter. When the leaf is flooded, water enters the space between the two layers and the iridescence fades. In a few species of *Selaginella* (e.g., *S. wildenowii*) the cells of the upper epidermis of the leaf contain a single cup-shaped chloroplast, similar to that of *Anthoceros* (p. 115) but lacking a pyrenoid.

Diagnostic of *Selaginella* is the insertion of a minute tongue-like ligule into the upper side of the leaf close to the axis. This organ appears early in the life of the leaf, but remains colorless since the plastids fail to develop internal lamellae or chlorophyll. Its cells contain prominent Golgi

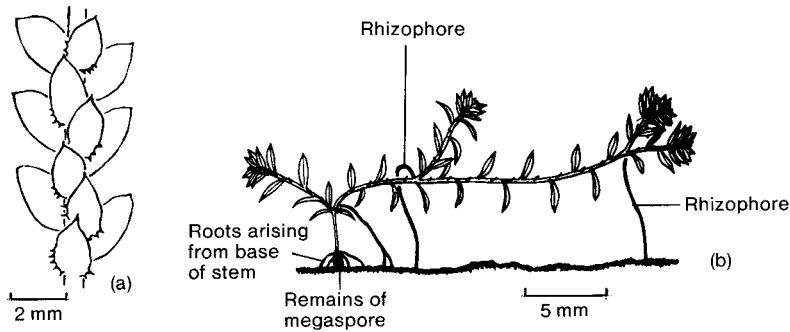

Figure 6.23 *Selaginella kraussiana*.
(a) Anisophyllous shoot viewed from above showing arrangement of upper and lower rows of leaves. (b) Young sporophyte.

begins just beneath the apex, and its peculiar form must be a consequence of the greater expansion of the cortical region than of the vascular, so

generating the intervening space. The endodermal cells remain alive and, as is usual in a well-formed endodermis, the plasmalemma forms a tight junction with the Casparian strip embedded in the radial walls.

The stele of *Selaginella* is basically a protosteles (p. 193) lacking internal parenchyma, but it is often ribbon-like instead of cylindrical, and, especially in aerial axes, several steles may ascend the stem together (polystely). The xylem is regularly exarch. The tracheids of the metaxylem often lack end walls, and in several instances can be regarded as forming authentic vessels. The end walls of the sieve cells tend to be more or less transverse, and pores are found in both the end and lateral walls. In the rhizomes of a few species the xylem is in the form of a hollow cylinder lined on both surfaces by phloem. An endodermis also occurs both externally and internally. Such a stele, which is said to be *amphiphloic* and is referred to as a *solenostele*, clearly exhibits a more complicated pattern of differentiation than a protosteles, but the factors controlling differentiation of this kind are still little known.

The meristems giving rise to rhizophores are indistinguishable from those of shoots in their early stages, but they appear to be indeterminate. If a branch is removed the adjacent primordium will grow out to form a shoot instead of a rhizophore. However, if the branch is replaced by a source of the growth-regulating substance indole-3-acetic acid (IAA, auxin), the primordium behaves normally. This was one of the first and most striking demonstrations of how growth-regulating substances, diffusing from one area to another in a plant, maintain the familiar pattern of morphogenesis. The form of growth in *Selaginella* seems to be particularly labile. The

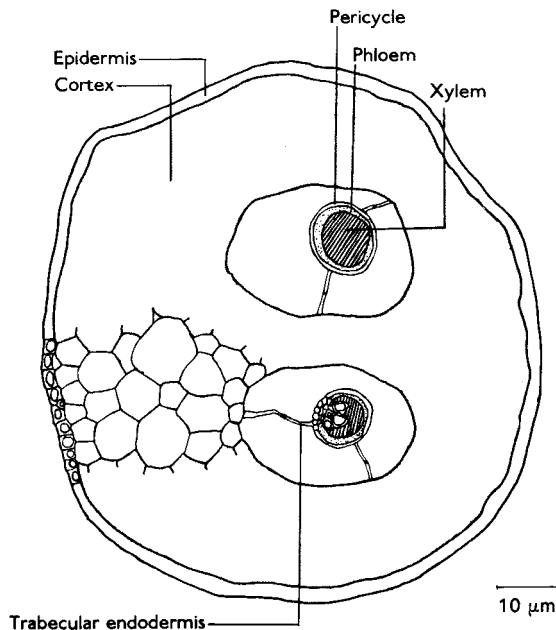

Figure 6.24 *Selaginella* sp. Transverse section of stem.

bodies. The whole structure is evidently specialized for the production and secretion of extracellular mucilage, but its activity is of limited duration. The ligule dies and shrivels to a papery fragment as the leaf expands.

The axis of *Selaginella*, unlike that of *Lycopodium*, grows from a well-defined apical initial whose divisions are wholly periclinal. In general the anatomy of the axis is little different from that of *Lycopodium*, but the endodermis is of a kind unknown elsewhere in the plant kingdom. At maturity it consists of elongated hypha-like cells which suspend the stele in a central cavity (Fig. 6.24). The development of the endodermis

Figure 6.25 *Selaginella kraussiana*.
Longitudinal section of strobilus.

apices of roots in pure culture in the absence of auxin may begin to produce leaf primordia and generate a shoot.

REPRODUCTION

The sporangia of *Selaginella* are borne in strobili (cones), which terminate the main or lateral axes. The sporophylls are usually in four ranks. Each sporangium lies in the axil of a sporophyll, between the ligule and the axis (Fig. 6.25).

There are two kinds of sporangia, producing mega- and microspores respectively, located in different regions of the cone. The initial development of each kind of sporangium is the same, and closely resembles that of the sporangia of *Lycopodium*. Development diverges with the formation of the spore mother cells. In the microsporangia all the mother cells undergo meiosis and form microspores, but in the megasporangia not all the sporogenous cells complete their development. Only one or a very few mother cells yield spores, and not all of these may persist. The consequence is that the number of spores reaching maturity is very small and ranges, depending upon species, from one (e.g., *S. sulcata*) to about twelve. The factors which determine the course of development of the sporangial primordium are as yet unknown, but in *S. wallacei* and *S. pallescens* it has been found that in the presence of ethylene (known to have hormonal properties), released *in planta* from 2-chloroethylphosphoric acid, the formation of megasporangia is promoted. Some such hormonal mechanism may control normal differentiation. The fully differentiated megaspores are conspicuous for their size, their store of food materials built up at the expense of the tapetum and the resorbed abortive sporogenous tissue and spores, and the thickening and ornamentation of their walls. In some species it has been possible to demonstrate a colloidal, crystal-like structure in the exine. This seems to be generated by a form of

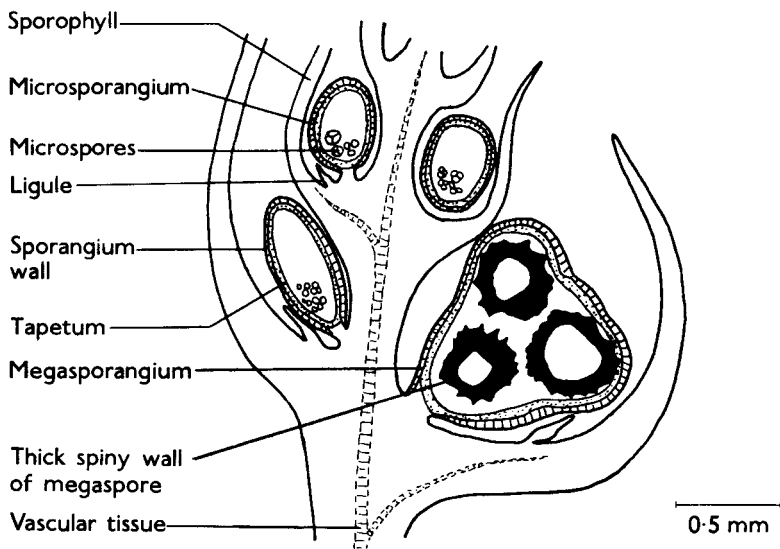

macromolecular self-assembly. Analogous structures can be generated *in vitro* in polymer systems in defined conditions, and their ultrastructural features can be almost indistinguishable from those of natural walls. *Selaginella* produces some of the most remarkable spores in the plant kingdom; the megaspores of *S. exaltata*, for example, may exceed 1 mm (0.04 in.) in diameter. Silica has been detected in the megaspore walls of some species.

The microsporangia of some species of *Selaginella* have a well-defined opening mechanism. The wall of the fully ripe microsporangium splits and the two valves gape open. They then shut violently, causing the spores to fly out of the sac. Other species lack any special form of dehiscence and the release of the microspores is passive. In some species (e.g., *S. selaginoides*) the microspores are distributed still adherent in tetrads. Megaspores may be distributed by a "sling shot" mechanism similar to the active discharge of microspores; those of *S. selaginoides*, for example, are ejected with some force, although in this species the release of the microspores is passive. In general, passive release of the microspores is not necessarily accompanied by a like release of the megaspores, and vice versa. Liberated megaspores are often found with microspores clinging to them. These chance associations may lessen the hazards of subsequent sexual congress.

Some nuclear divisions occur in the spores

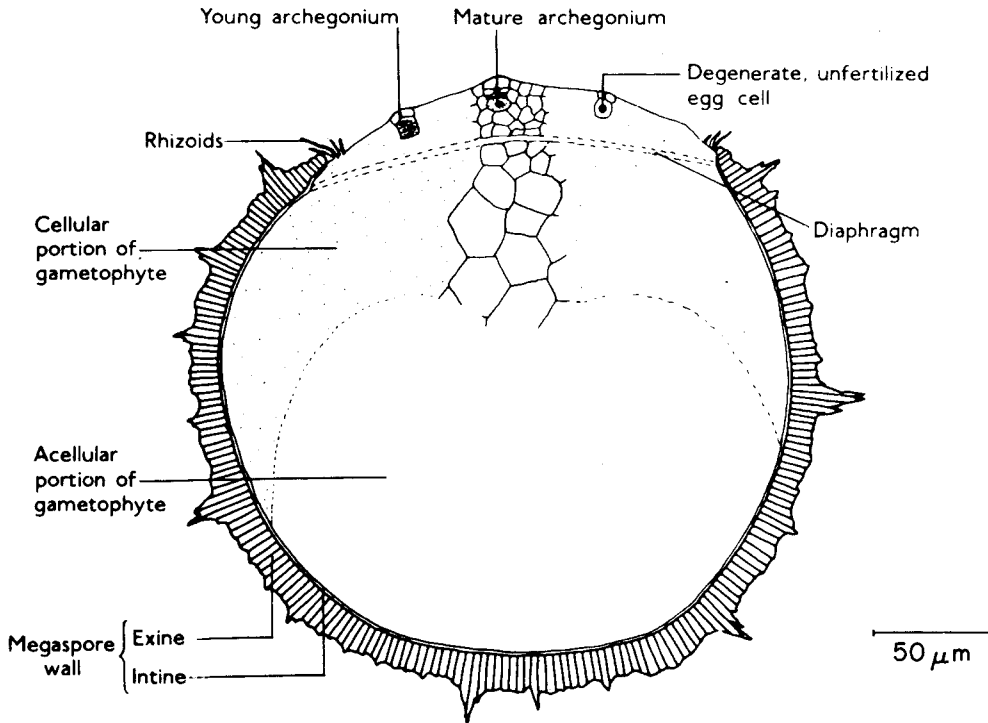

Figure 6.26 *Selaginella kraussiana*. Vertical section of megaspore with endosporic gametophyte.

while they are still in the sporangia, but growth of the gametophytes, leading to rupture of the spore wall, does not resume until after the spores are shed. In the microspore an unequal mitosis produces a large antheridial cell and a small cell, termed a *prothallial cell*, which represents the sole development of the somatic tissue of the gametophyte. The antheridial cell continues to divide and yields a normal antheridium, from which 128 or 256 biflagellate spermatozoids are eventually liberated. Each is about 25 μm long, with a narrow elongated nucleus in which longitudinal strands, probably of chromatin, become apparent during differentiation. Although the spermatozoids of *Selaginella* have a general resemblance to those of bryophytes (p. 104), the former differ in having an anterior mitochondrion longer than the nucleus. *Selaginella* may be unique in this respect. In bryophytes the nucleus extends for most of the length of the spermatozoid. The small volume of the nucleus of the *Selaginella* spermatozoid suggests that its content of DNA may be lower than that recorded for mosses (0.38–0.92 pg), possibly

approaching that in the gamete of the anthocero-rote *Notothylas* (c. 0.17 pg).

In the megaspore the food material comes to occupy a central position, and free nuclear division occurs at its periphery. Subsequently cell formation begins beneath the triradiate scar, which is eventually forced open by the general swelling, exposing a cap of gametophytic tissue (Fig. 6.26). The somatic tissue of the female gametophyte is thus more extensive than that of the male, although chlorophyll is quite absent from both. There is some specific variation in the extent to which the cellular portion of the female gametophyte is delimited from the food supply below. In some species the boundary is imprecise, and cell formation gradually extends down into the lower region, but in other species a distinct diaphragm separates the upper cellular region from a largely acellular food reserve.

The female gametophyte, once exposed, protrudes as an irregular cushion bearing rhizoids at its margin and, in the central region, archegonia. The necks of the archegonia are very short, consisting of no more than two tiers of cells (Fig. 6.27). Fertilization necessarily depends upon a microspore germinating close to a megaspore, and a

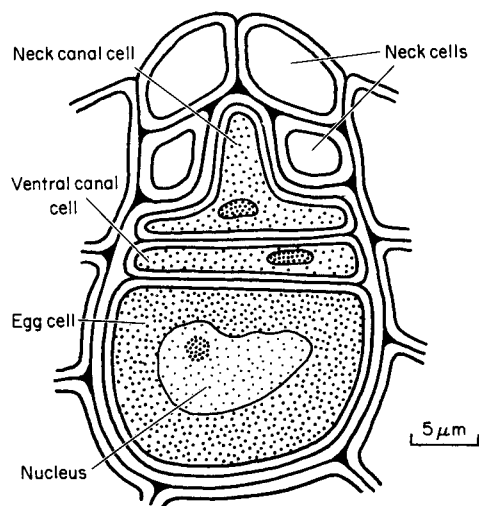

Figure 6.27 *Selaginella kraussiana*. Mature archegonium (from an electron micrograph).

film of water being present when the gametangia are mature. The rhizoids around the female gametophyte may in these conditions serve to retain a “fertilization drop” above the archegonia in which the spermatozoids congregate.

The embryogeny of *Selaginella* is like that of *Lycopodium* in being endoscopic, but differs in the greater development of the suspensor, and the wide variation in detail between species. In *S. selaginoides*, for example, elongation of the suspensor pushes the developing embryo down into the food reserve. In *S. kraussiana*, however, in which the food reserve is cut off by a diaphragm, the development of the suspensor is markedly less, but a curious downward extension of the archegonial canal carries the embryo through the diaphragm into the center of the gametophyte. Apart from these features, there is also variation in the development of the foot region of the embryo, and in the relative positions in which the various parts of the embryo arise. In all species the embryo eventually emerges from the upper surface of the gametophyte (Fig. 6.28).

The substantial thickening of the megaspore wall in *Selaginella* probably protects the spore for considerable periods from desiccation and decay. Once conditions are favorable for germination, development is rapid and, because of the consid-

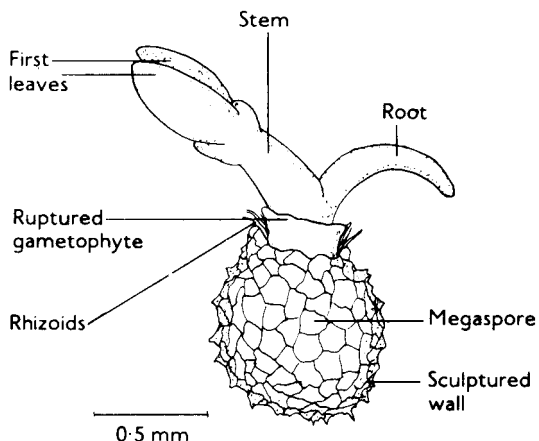

Figure 6.28 *Selaginella kraussiana*. Sporophyte emerging from gametophyte.

erable food reserve of the megaspore, independent of an external supply of nutrients. Compared with the life cycle of the homosporous *Lycopodium*, there is considerably less time spent in the gametophytic phase. Since this, in view of the delicacy of the gametophytic tissues and their dependence on the maintenance of humid conditions, is the most vulnerable phase of the life cycle, the modifications that lead to its curtailment no doubt confer a considerable selective advantage on *Selaginella*. This is perhaps reflected in its numerous species.

In some species of *Selaginella* (e.g., *S. rupestris*) young plants emerge from the female regions of strobili. This has been regarded as following from the lodging of microspores between the megasporophylls and the fertilization of an egg while the megaspore was still *in situ*, thus simulating an early step in the evolution of a seed. It is doubtful, however, whether this can be sustained. In *S. rupestris*, at least, reproduction is apogamous, the megaspore producing an embryo directly without fertilization.

FOSSIL HISTORY

Plants indistinguishable from living *Selaginella* in vegetative morphology are known from the Carboniferous Coal Measures. *Miadesmia* (p. 146) probably represents an extreme development of selaginellean heterospory in response to the conditions prevalent at that time, and parallels the

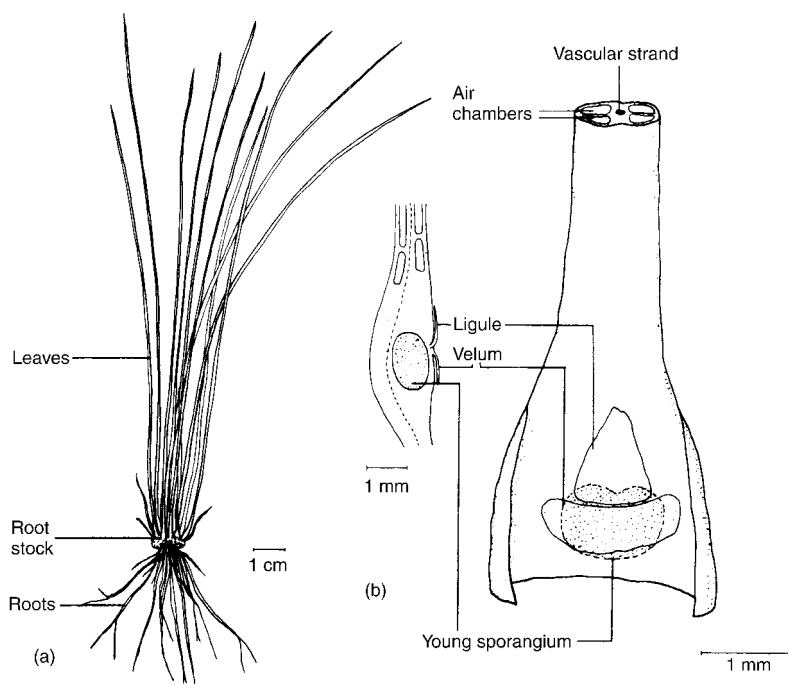

Figure 6.29 *Isoetes echinospora*. (a) Habit. (b) Leaf base with young sporangium in face view and longitudinal section.

representatives, contained in the single genus *Isoetes*, are aquatic, or plants of situations subject to periodic or seasonal inundation. The leaves of the aquatic species lack stomata.

Isoetes is widely distributed. The rootstock in all species is mostly below the level of the substratum. The meristem at the upper end of the rootstock is depressed. Although it often shows a conspicuous apical cell, divisions of this cell are both anticlinal and periclinal, not strictly anticlinal as in *Selaginella*. The leaves, which

general success of the heterosporous condition in the Upper Carboniferous. The Jurassic and Cretaceous periods and the Tertiary era yield abundant evidence of herbaceous forms very similar to *Selaginella*, commonly occurring as dispersed megaspores with a surface ornamentation of characteristic form and a wall with a characteristic ultrastructure. Although a ligule has not been demonstrated, *Selaginellites hallei*, for example, can be accepted with confidence. This was a small heterophyllous plant, with leaves faintly denticulate at the margin, like those of many species of *Selaginella*. There were four megaspores in each megasporangium, and each megaspore reached a diameter of about $500\ \mu\text{m}$, about 10 times the size of the microspores. With its clear fossil record, *Selaginella* has a strong claim to be the oldest living tracheophyte genus.

The Isoetales

The members of the order Isoetales have a remarkable, rush-like habit, quite unlike that of any other lycopodiopsid. The short, fleshy, upright rootstocks occasionally show one or two dichotomies. Each branch bears a tuft of quill-like microphylls (Fig. 6.29). The microphylls are ligulate, and reproduction is heterosporous. All living repre-

in some aquatic species may reach a length of 70 cm (27 in.), are arranged at first distichously, but subsequently in a dense spiral around the meristem. The roots arise from the lower end of the stock where the meristem is again depressed, but here lies extended along a transverse cleft. The roots are initiated at the base of the cleft (Fig. 6.30).

Accompanying this singular morphology is an equally remarkable manner of growth. A cambial zone consisting of more or less isodiametric cells arises around the small amount of primary vascular tissue in the stock, but it contributes more to the cortex than to the stele. The activity of this cambium, in temperate species at least, is seasonal. In step with the addition of new material within, a girdle of outer tissue, complete with its decaying leaves above and roots beneath, sloughs away. Consequently, having reached its mature diameter (which may exceed its length), the stock remains more or less the same size, the new leaves and roots being carried up on to the shoulders of their respective meristems by the expansion of the products of the anomalous cambium.

The anatomy of the stock presents a number of peculiar features. The primary xylem consists of more or less isodiametric tracheids, and at the

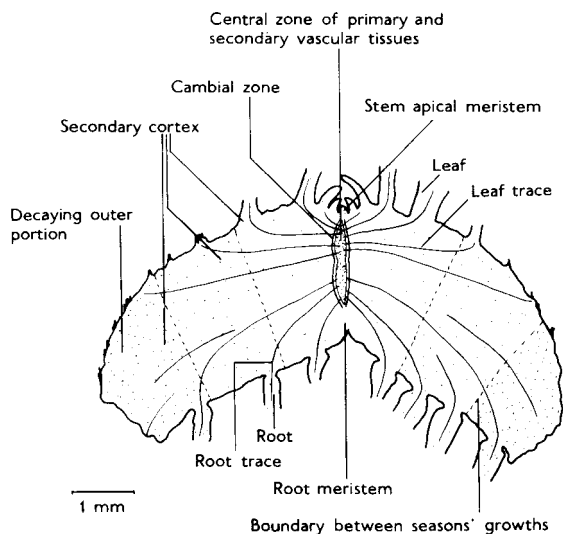

Figure 6.30 *Isoetes echinospora*. Median vertical section of rootstock in plane perpendicular to that of the basal cleft.

base of the stele they are arranged in an anchor-like bifurcation lying in the same plane as the basal cleft of the stock. The tissue produced on the inside of the anomalous cambium differentiates as a mixture of tracheids, sieve cells and parenchyma. The remainder of the tissue in the stock is parenchymatous, and no recognizable endodermis delimits the vascular tissue.

The leaves contain a single vascular strand, often very tenuous, surrounded by four air canals, interrupted at intervals by transverse septa. These canals are especially striking in the aquatic species. The broadened leaf bases lack chlorophyll and overlap widely, forming a tight comal tuft. The roots possess a single vascular strand surrounded by a cortex of two distinct zones: an outer fairly resistant to decay, and an inner of more delicate tissue with numerous air spaces.

In a North American mat-forming species of *Isoetes* the leaf arrangement remains distichous, and the rootstock extends laterally in the plane of the leaves. Adventitious buds arise at the extremities of these extensions and give rise to additional plants. An Andean species of *Isoetes* (formerly *Stylites*), found only by the sides of glacial lakes at high altitudes, is outstanding in that the rootstock is dichotomously branched. The plant in consequence forms dense cushions which may reach a height of 15cm (6in.). The roots are

confined to a single furrow which runs along one side of the stock. The leaves regularly lack stomata. Carbon dioxide is apparently taken in through the roots. It has been suggested that *Stylites* may be a relict of astomatal forms which were present in the transigrants invading the land in early Paleozoic times.

REPRODUCTION

Mature plants of *Isoetes* are usually abundantly fertile. The leaves first formed in a season's growth bear megasporangia, and those later microsporangia, although the sporangia frequently abort on the last-formed leaves. The sporangium is initiated much as in *Selaginella* between the ligule of the sporophyll and the axis, but distinctive features emerge as development proceeds. Part of the central tissue, for example, remains sterile and differentiates as trabeculae which divide the mature sporangium into a number of compartments. Also, the ripe sporangium becomes enclosed in a thin envelope (velum). This originates just below the ligule and grows down over the sporangium, leaving a central pore (foramen).

In the megasporangium, part of the sporogenous tissue degenerates, resulting in many fewer sporocytes than in the microsporangium. Mature megasporangia contain 100 or more megaspores, ranging from 200 μm to almost 1 mm (0.04 in.) in diameter. The microsporangia, in which there is no loss of sporocytes, may contain up to 10^6 spores, each about 40 μm in maximum diameter. *Isoetes* is peculiar in that the microspores are monolete and the megaspores are trilete. Not only is this genus unique in the living lycopodiopsids in producing monolete spores, but *Isoetes* is also amongst the few plants in which monolete and trilete spores are produced by the same individual. Monolete spores can be considered as formed by the bisection of two conjoined hemispheres by a plane perpendicular to the equator (Fig. 6.31). The linear scar thus represents the line of common contact between the four segments. This is in contrast to the tetrahedral arrangement of most pteridophyte spores, where the three contact faces leave a trilete scar. In a few species of *Isoetes*, microspores and megaspores occur in the same sporangium, but the viability of the spores

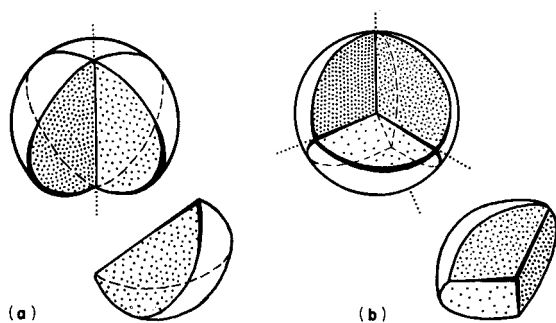

Figure 6.31 Diagrammatic representation of manner of formation of (a) monolet and (b) trilete spores.

has not been tested. Reproduction in these species may be aberrant.

The spores are liberated by the decay of the sporophylls. In their subsequent germination and development they resemble the micro- and megaspores of *Selaginella*. In *Isoetes*, however, the male gametophyte is wholly endosporic. The single antheridium yields only four spermatozoids, differing from those of *Lycopodium* and *Selaginella* in being multiflagellate. They are released by rupture of the microspore wall. The female gametophyte is similar to that of *Selaginella*. Cell formation usually extends down into the body of the spore, and the diaphragm seen in many species of *Selaginella* is absent. Although initially endosporic, the expanding gametophyte ruptures the megaspore at the site of the triradiate scar, but, as in *Selaginella*, fails to develop chlorophyll. The archegonia are also similar, but the necks consist of four tiers of cells in place of two.

The first division of the zygote is slightly oblique. No suspensor is formed, but the embryogeny can still be termed endoscopic since the outer cell gives rise to the foot and the remainder of the embryo comes from the products of the inner cell. Differential growth causes the embryo to turn round so that it becomes directed toward the upper surface of the gametophyte. It eventually breaks through, but the young plant remains for some time partially enclosed by a sheath of gametophytic tissue.

Apogamy has been reported in triploid species of *Isoetes*. Asexual reproduction by the production of a bud in place of a sporangium is not uncommon.

FOSSIL HISTORY

Although *Isoetes* is like other lycopodiopsids in essentials, it exhibits a number of outstanding features unrepresented elsewhere in archegoniate plants. It appears to be a product of a line of lycopodiopsid evolution that has been independent for a considerable period. The reasonable hypothesis that the Isoetales have been derived by reduction from arborescent antecedents such as *Pleuromeia* (Fig. 6.15) now seems, following the discovery of fossils of small, *Isoetes*-like plants in Triassic rocks, altogether improbable. *Nathorstiana* from Cretaceous rocks of Germany, once considered part of this reduction sequence, undoubtedly recalls *Isoetes*. An upright rootstock, made irregular by leaf scars, reached a height of about 12 cm (4.8 in.) and bore a crown of needle-like leaves. The base was divided into a number of vertical lobes, between which the roots emerged. The plant probably demonstrates that, at intervals, the largely diminutive Isoetales have explored a more upright habit.

Tracheophytes with terminal sporangia (Euphyllophytina)

Trimerophytosida

The Trimerophytosida were not unlike the Rhyniopsida, but are distinguished by a general tendency to a monopodial habit and by laterals which branched freely, either dichotomously or even trichotomously. The evolutionary progression leading to these forms has been much debated, but it seems likely that unequal extension following a dichotomy could lead to "overtopping", and ultimately a main stem bearing complex lateral branch systems. The "telome" theory of Zimmerman (Fig. 6.32) offers a plausible sequence of events which could have led to a monopodial growth form.

The stems of the trimerophytosids were either naked or sometimes furnished with small spines. The xylem was in the form of a protostele with the protoxylem toward the center (endarch). The metaxylem tracheids often had scalariform thickening. The wall also contained bordered pits, with strands of secondary wall material extending across the pit aperture. There is a resemblance to

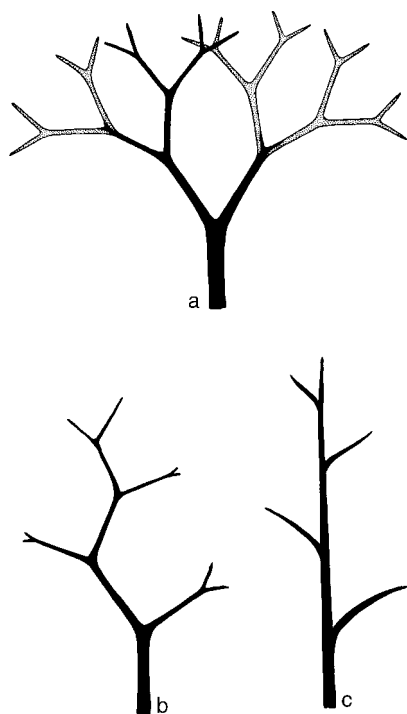

Figure 6.32 Diagram showing how a pseudomonopodial branch system could be derived from a dichotomous system by way of "overtopping" following the sequence (a)–(c). (From Stewart and Rothwell. 1993. *Paleobotany and the Evolution of Plants*, 2nd edn. Cambridge University Press, New York.)

the Lycophytina form of tracheid. As there, in fossil material the interior of the thickenings often appears empty, presumably because of degradable material having been replaced by matrix. The genus *Psilophyton* (Fig. 6.33) from the Lower Devonian is representative of the trimerophytosids. In some forms the monopodial habit was well established. In *Pertica*, for example, from the Lower Devonian in North America, there was a distinct main axis with the lateral branches inserted in four ranks. The sporangia of the trimerophytosids were terminal, usually fusiform, and often in tassels. In *Pertica*, 50 or more occurred crowded together at the end of a spray of branchlets. So far as known all these plants were homosporous.

Although they became extinct at the end of the Devonian, the Trimerophytosida are extremely significant since they appear to have been ancestral to all the megaphyllous vascular plants (Euphyllophytina). These are represented

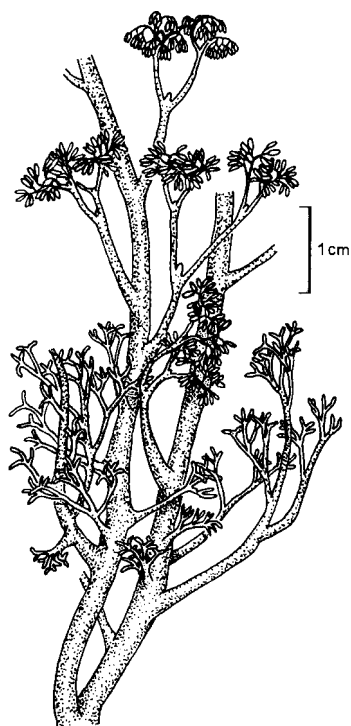

Figure 6.33 *Psilophyton dawsonii*. (After Banks, Leclercq and Hueber. 1975. *Palaeontographica Americana* 8.)

by the extinct Cladoxylopsida and Progymnospermopsida, and the ferns, horsetails, gymnosperms and flowering plants (angiosperms), all of which have living representatives.

Equisetopsida

As with the Lycopodiopsida, the class Equisetopsida (horsetails) also contains both living and fossil representatives. All share a recognizable morphology. The general features of the class can be summarized as follows:

- Sporophyte consisting of a monopodial branch system, some axes rhizomatous and bearing roots.
- Leaves microphyllous, unbranched and reduced (except in some early forms), borne in whorls.
- Vascular tissue of tracheids and phloem.
- Sporangiophores peltate, aggregated in terminal strobili. Living forms homosporous, but some fossil forms heterosporous. Gametophytes known only of living forms, terrestrial. Spermatozoids multiflagellate. Embryogeny exoscopic.

Four orders are recognized: the Equisetales (containing *Equisetum* and a number of fossil

genera), and the extinct Calamitales, Sphenophyllales and Pseudoborniales. Only *Equisetum* is living.

The early Equisetopsida

The fossil record of the Equisetopsida parallels that of the Lycopodiopsida, beginning early in the Paleozoic and expanding in the Carboniferous, when the Equisetopsida must have formed a large part of the Earth's vegetation. From the end of the Paleozoic to the present time they have been of diminishing importance until today only a single genus remains.

The Calamitales

The fossil equisetopsids which show the closest resemblance to *Equisetum* are the Calamitales. One of the earliest may have been *Archaeocalamites* from the Upper Devonian and Lower Carboniferous. This was an arborescent plant with secondary vascular tissue, the mature stems reaching about 1.5 cm (0.6 in.) in diameter. The branches were whorled and the stem ribbed, but the ribs did not alternate as in living *Equisetum*. The upper branches bore leaves, also in whorls, which dichotomized several times, sometimes reaching a length of 10 cm (4 in.). *Calamites*, which flourished in the Carboniferous forests, is altogether better known (Fig. 6.34). These plants had a creeping rhizome from which arose massive aerial stems bearing whorls of branches. In some forms the main axis reached a diameter of about 15 cm (6 in.) and a height of at least 20 m (65.5 ft). The calamites probably formed a second storey beneath the arborescent lycopodiopsids. The stems of *Calamites* were conspicuously ribbed, the ribs in some forms alternating from node to node, and in others colinear. Although *Calamites* is often represented only by pith casts, petrifications are also known which have revealed details of the anatomy. There was a basic similarity to *Equisetum*, and the protoxylem was associated with a canal. Subsequently a cambium arose between the primary xylem and phloem and contributed substantial amounts of secondary vascular tissue to the stem. Another difference from *Equisetum* was that no air canals were present in the cortex. The axis did, however, grow, as in *Equisetum*, from a single apical cell, beautifully preserved in some

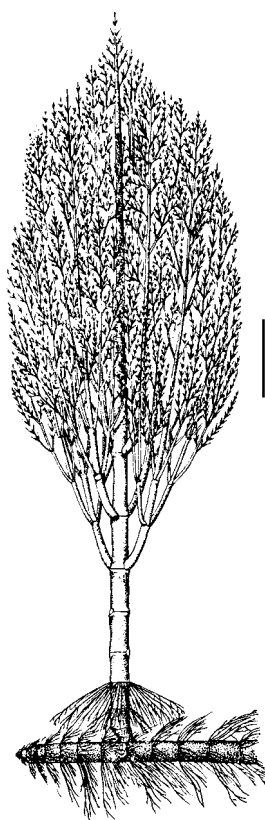
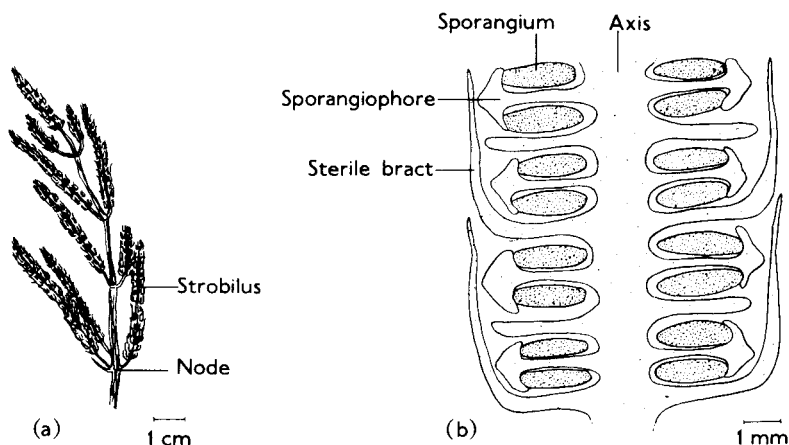

Figure 6.34 *Calamites*, reconstruction. Scale bar 1 m. (From Stewart and Rothwell. 1993. *Paleobotany and the Evolution of Plants*, 2nd edn. Cambridge University Press, New York.)

specimens. The leaves of *Calamites* were simple with a single median vein. The subsidiary cells of the stomata bore transverse bars of cutin (see Fig. 6.39).

The strobili of the Calamitales, which terminated lateral branches, consisted of alternate whorls of sporangiophores and bracts, although the cone of one early form appears to have contained peltate sporangiophores alone. Since cones are often found detached, they are placed in form genera, defined by the relative arrangements of the sporangiophores and bracts. The two form genera most widely represented are *Calamostachys* (Fig. 6.35) and *Palaeostachys*. The cones assigned to these form genera may, of course, have been produced by plants differing widely vegetatively. Both homosporous and heterosporous cones have been described, and in at least one (*Calamocarpon*) the megasporangium appears to have contained only

Figure 6.35 *Calamostachys*. (a) *C. ludwigi*. Fertile shoot (from a compression). (b) *C. binneyana*. Longitudinal section of cone. ((a) after Weiss, from Andrews. 1961. *Studies in Paleobotany*. Wiley, New York; (b) after Andrews. 1961. *Studies in Paleobotany*. Wiley, New York.)



one functional megaspore. The evolution of heterospory in the Calamitales appears to have paralleled that in the Lepidodendrales, but there is no evidence of its having reached the seed-like formations of *Lepidocarpon* and *Miadesmia* (p. 146). In *Elaterites* (possibly the microsporangiate cone of a heterosporous calamite) the spores had *Equisetum*-like elaters.

The Sphenophyllales

The Sphenophyllales, another order of the equisetopsids, appeared in the late Devonian and were prominent in Carboniferous floras. They share little with the Equisetales and Calamitales except the whorled arrangement of the leaves. They were probably scrambling plants, supporting themselves on other vegetation in the manner of the familiar *Galium aparine* (cleavers or goose-grass). The leaves were wedge-shaped, with dichotomously branching venation, and were usually borne in multiples of three (Fig. 6.36). The stems contained a solid core of primary xylem, triangular in transverse section, with protoxylem at the vertices. The primary xylem was surrounded by secondary in radial files, resulting in a vascular system strikingly reminiscent of that of a root. These stems of *Sphenophyllum* provide the finest example in the Paleozoic of a spore-bearing plant in which well-defined secondary vascular tissue, both xylem and phloem, was regularly produced from a bifacial cambium. The strobili were terminal and frequently consisted of whorls of sterile bracts, each forming a cup-like sheath around the axis, on the adaxial side of which were attached the sporangiophores (Fig. 6.35b). The distal portion of the sporangiophore, which was free, branched and recurved, bore a number of sporan-

gia. In other forms of cone the sterile part was less well developed, and the sporangiophore branching more complex. Most of the cones were homosporous, but distinct heterospory has been detected in one form. The Sphenophyllales disappeared at the beginning of the Triassic period.

The Pseudoborniales

The Pseudoborniales are based upon remains from the Upper Devonian of Bear Island and Alaska. They appear to have been sizeable trees, many branches reaching a diameter of 10 cm (4 in.) and the main axes as much as 60 cm (24 in.). The leaves, borne in whorls of four, were branched once or twice. The upper branches terminated in loose cones, up to 30 cm (12 in.) in length, consisting of whorled bracts and sporangiophores. These branched several times, each ultimately producing about 30 sporangia. Although their general features are in accord with the Pseudoborniales being placed with the Equisetopsida, little is known about them. They appear to have been a minor evolutionary line which disappeared relatively quickly.

The living Equisetopsida

The Equisetales

The striking feature of the Equisetales is the jointed structure of the stem, and, in the regions of uniform diameter, the regular alternations of the microphylls in the successive whorls. The stems are often conspicuously ridged, each ridge being in line with the leaf above. Consequently,

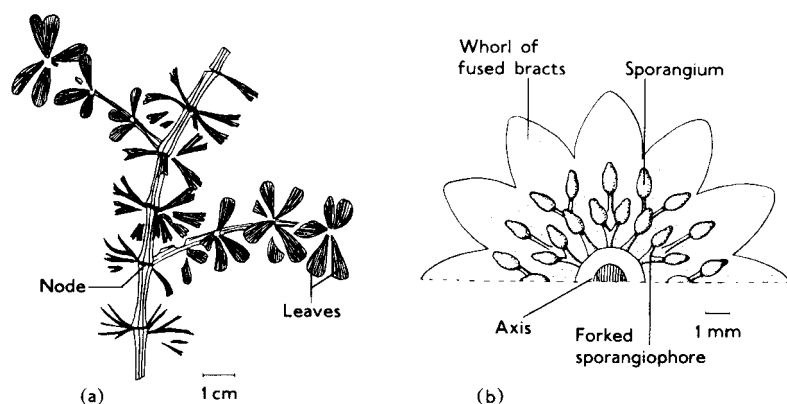

Figure 6.36 *Sphenophyllum*. (a) *S. verticillatum*. Habit of vegetative shoot (from a compression). (b) *S. (Bowmanites) dawsoni*. Fertile whorl viewed from above. ((a) after Potonié. 1899. *Lehrbuch der Pflanzenpalaeontologie*. Dümmler, Berlin; (b) after Hirmer. 1927. *Handbuch der Palaeobotanik*. Oldenbourg, Munich.)

provided the number of leaves in a series of whorls remains the same, the ridges also show regular alternation from one internode to the next.

Equisetum (Fig. 6.37a), the horsetail, is a familiar sight in parts of the north temperate zone, but is rarer in the tropics and southern hemisphere, being absent altogether from Australia and New Zealand. About 15 species are now living, but others are known as Mesozoic fossils. The genus, or a form very closely similar, was widespread in Cretaceous times, and some species appear to have formed dense stands at the fringes of Cretaceous lakes. Moist habitats, such as river banks and marshy ground, are also favored by most living species, but some are able to thrive in much drier places. *Equisetum arvense*, for example, often flourishes on well-drained railway embankments. All species have a similar growth form. A perennial underground rhizome gives rise to green aerial shoots, and occasionally also to perennating tubers packed with starch. In temperate and arctic regions the aerial shoots die back at the end of the growing season and new shoots emerge in the following spring.

Although the height of the aerial system of *Equisetum* varies from a few centimeters in arctic and alpine species to as much as 10 m (33 ft) in the tropical *E. giganteum*, its morphology is strikingly uniform. Branches appear only at the nodes, and where several are present they too are whorled. The branch primordia are not, however, axillary, but they arise between the microphylls (Fig. 6.37b) and eventually break through the sheath formed by their congenitally fused bases. In subterranean

axes roots emerge from directly below the sites of branch primordia. Branch and root primordia are in fact present at every node, but they develop only in appropriate environmental conditions, sometimes reproducible in the laboratory. In *E. arvense*, for example, green branches can be made to grow from the nodes of an etiolated unbranched fertile shoot if they are enclosed in a moist chamber.

The structure of the axes of *Equisetum* also shows little variation. The mature stems have a large central cavity, surrounded by a ring of vascular bundles (Fig. 6.38). These bundles are of the same number as the ribs on the outside of the internode (and hence as the leaves of the node above), and are also co-radial with them. An endodermis can usually be distinguished, either encircling the stele on the outside alone (as in *E. arvense*), or forming two continuous cylinders, one inside and one outside the ring of bundles (as in *E. hyemale*), or surrounding each bundle individually (as in *E. fluviatile*). In some species the position of the endodermis in the rhizome is different from that in the aerial stem. Alternating with the vascular bundles, and lying between the endodermis and the periphery, are large longitudinal air chambers known as *vallecular canals*. The continuity of the central cavity is interrupted at the nodes by parenchymatous septa.

The vascular bundles themselves contain very little lignified tissue. In a differentiated internode the protoxylem is represented solely by fragments of tracheids adhering to the sides of a cavity, termed the *carinal canal*, present on the adaxial side of each bundle. The metaxylem differentiates

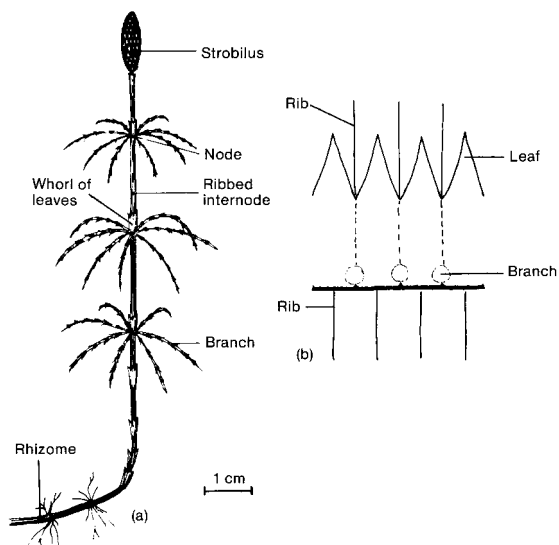

Figure 6.37 *Equisetum sylvaticum*. (a) Habit. Early summer condition, after production of vegetative branches, but before shedding of cone. (b) Diagram showing arrangement of leaves and ribs at a node at which there is exact alternation.

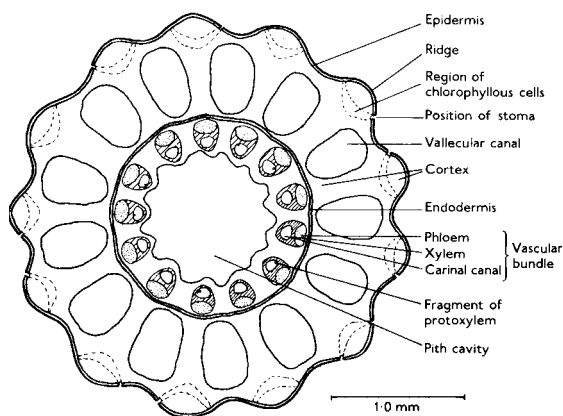

Figure 6.38 *Equisetum arvense*. Transverse section of young stem.

as two groups of tracheids, one placed tangentially on each side of the phloem. The cells between the phloem and the carinal canal frequently develop labyrinthine walls. These may regulate the flow of solutes from the symplast of the sieve cells to the apoplast of the canal. The vascular anatomy of the nodes is highly peculiar. Here the tracheids, resembling those of the metaxylem, run horizontally and form a ring linking the bundles of the adjacent internodes. In

E. hyemale the phloem close to the node is notable in lacking well-defined sieve cells. The root, branch and leaf traces also originate at the level of the node, the leaf trace departing immediately above the entry of the bundle from the internode below.

The strength of the *Equisetum* stem depends principally upon the cortical ridges. These consist of sclerenchymatous cells reinforced by deposits of silica. The nodal septa have also been shown to add to the rigidity of the axis. The support this form of construction can provide is evidently limited and stems frequently buckle under mechanical stress. The taller species of *Equisetum* usually grow in groves and, since the rough siliceous stems and branches do not readily slide over each other, the plants hold each other up.

The microphylls of *Equisetum* soon become scarious, and photosynthesis takes place predominantly in the surface layers of the stem. Apart from a few curious "water stomata" or hydathodes in the adaxial epidermis of the tip of the microphyll, the stomata are confined to the valleys of the internodes, and thus lie above the vallicular canals. The stomata are often deeply immersed, merely a pore being visible externally. Each guard cell is flanked by a subsidiary cell, and each subsidiary cell bears transverse bars of cutin on its exposed surfaces (Fig. 6.39).

The growth of the axis of *Equisetum* provides a striking example of coordinated differentiation. The axis is surmounted by a single tetrahedral apical cell. The extent to which this particular cell undergoes division is disputed, but adjacent to its three posterior faces daughter cells are cut off in a regular, clockwise sequence. While the stem is growing there is no pause in the meristematic activity of the apical initials and their products are recognizable as three tiers of cells in the extreme apex. The formation of a whorl of leaves is first indicated by the elevation of a ring of meristematic tissue at the base of the conical apex. While this ring is being superseded by another, leaf teeth initials become visible around the upper margin of the first. These initials are of limited growth and give rise to the free part of the microphylls, the basal ring meanwhile forming the sheath of fused bases.

The upper three or four nodal primordia

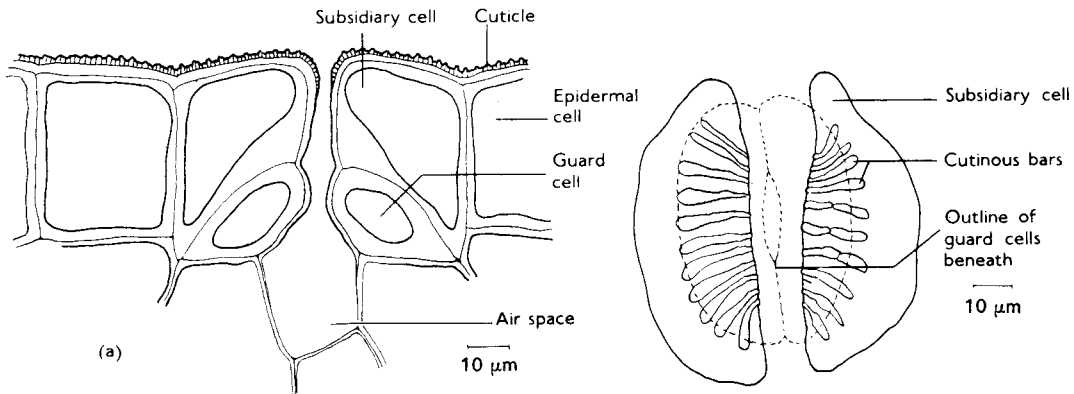

Figure 6.39 *Equisetum* sp. Structure of stomata. (a) In vertical section. (b) In surface view partially macerated, showing the bars of cutin on the subsidiary cells. (After Hauke, 1957. *Bulletin of the Torrey Botanical Club* 84.)

remain close together, but the cells between them become organized as an intercalary meristem which surrounds, but does not cut across, the procambial strands. This meristem becomes active between the fourth and fifth nodes, and cuts off cells acropetally which go to form the internode. The activity continues while four or five new nodes are initiated at the apex. In consequence the mature length of the internode is reached by about the ninth or tenth node. The secretion of silica on to the surface of the internode begins at the top and proceeds downward, becoming completed as the intercalary growth ceases. The metabolic pathway of the silica and the manner of its secretion are not yet understood.

The procambial tissue, the disposition of which foreshadows that of the vascular bundles in the mature axis, advances continuously, in step with the advance of the apex, and is always to be found at the level of the uppermost leaf whorl primordia. Differentiation of the procambial strand is not, however, a simple acropetal process. Protoxylem begins to appear at about the fourth node, and differentiation extends acropetally into the leaf and basipetally into the node below. Since this differentiation occurs during the time of maximum extension, most of the tracheids first formed in the internode are ruptured, and the area of weakness provided by the differentiating cells is pulled apart by the radial and tangential expansion of the stem, so yielding the carinal

canal. Metaxylem begins to appear at the fifth node, and also differentiates basipetally. The rate of differentiation is such that the descending strands do not fuse with the metaxylem of the node beneath until the tenth node, when extension of the internodes is ceasing. The internodal metaxylem thus escapes rupture, although occasional small lacunae indicate that it is subjected to some stress during the concluding phases of differentiation. The differentiation of the phloem follows more or less the same course as that of the metaxylem.

In temperate and arctic habitats the aerial branches perish in the winter, and in this instance the growth of the shoot is a little different from that just described. Almost the whole of the next year's shoot overwinters in primordial form as a subterranean bud. In spring elongation of the internodes and further differentiation proceeds acropetally, so generating an aerial system of limited growth.

REPRODUCTION

In all species of *Equisetum* the sporangiophores are aggregated into a terminal strobilus (Fig. 6.40) which terminates either a vegetative axis (as in *E. palustre*) or a specialized axis lacking pigmentation which appears early in the growth season (as in *E. arvense*). An intermediate state is shown by *E. sylvaticum*, in which the fertile shoots are at first colorless, but after release of the spores become green and branch. The vascular system inside the cone recalls that of a node, since it consists of a cylinder of metaxylem. Fine traces depart to the sporangiophores, and the cylinder is broken here and there by parenchymatous perforations which

Figure 6.40 *Equisetum maximum*.

(a) Median longitudinal section of strobilus. (b) Peltate sporangiophore. (c) and (d) Spores with elaters in dry and moist condition respectively.

bear no evident relation to the departing traces. The sporangiophores, which are not necessarily arranged in whorls, are peltate, and are tightly packed so that heads acquire a polygonal outline. About 20 sporangia are pendent from the margin of the head, and so lie more or less radially in the intact cone.

A sporangium develops from a group of cells, in which a central archesporial tissue, surrounded by a wall several layers thick, can soon be distinguished. The inner layer of the wall functions as a tapetum, together with about a third of the archesporial tissue, the remainder being sporogenous.

Groups of sporogenous cells tend to become separated by non-sporogenous tissue, possibly accounting for some lack of synchrony in meiosis within a sporangium. The spore output is nevertheless very high. The manner in which the spore wall is formed is complex and unique in the Pteridophytina. After the laying down of a thin layer of exine, four spirally arranged elaters are added as a further outer layer. Each consists of two parts: an inner band of cellulose microfibrils (parallel to arrays of microtubules in the adjacent plasmodial tapetum) and an outer covering of homogeneous material secreted from the tapetum. The elaters are not acetolysis-resistant and can therefore be taken to lack sporopollenin. When extended the elaters form an X, remaining attached to the spore only at the intersection. The mature spore retains no triradiate scar.

The mature sporangium opens along a longitudinal stomium as the result of tensions arising from the drying out of spirally thickened cells elsewhere in the wall. When the spores are freed the elaters lift and respond to changes of humidity with jerky movements which assist in the dis-

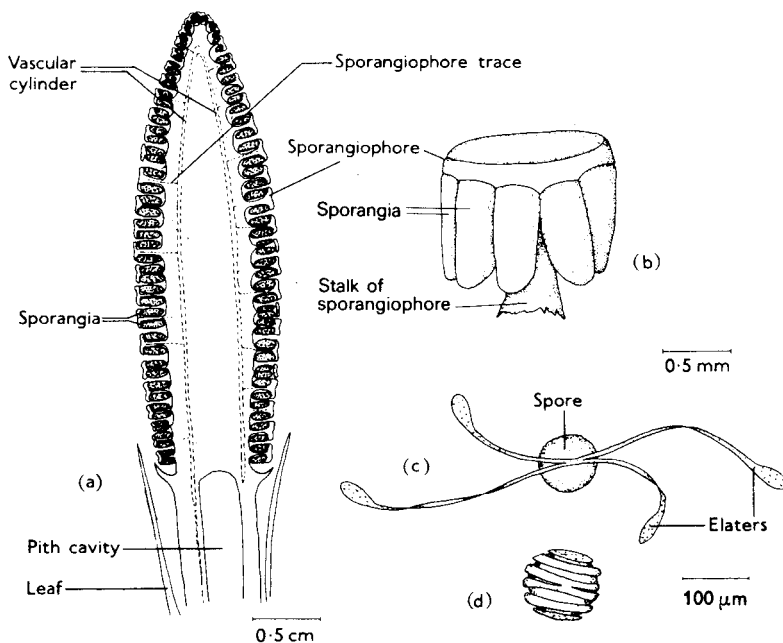

tribution of the spores. The entanglement of the elaters also ensures that the spores are dispersed in groups.

Equisetum is usually considered to be homosporous. In *E. arvense* a large sample of spores falls into two classes whose mean diameters differ by about 10 μm , but this is probably an effect of drying. The spores, which contain chlorophyll, soon lose their viability if stored. On germination the cellulosic inner layer of the spore wall is continuous with the wall of the emerging filament. A high concentration of potassium ions has been demonstrated at the site of germination. This probably leads to a local increase in the plasticity of the wall, since potassium ions are known to reduce the amount of cross-linking in cellulose microfibrils. The initial filament is transformed by division in a number of planes into a cushion of cells anchored by rhizoids. Subsequent growth is from a marginal meristem which forms a number of obliquely ascending lobes (Fig. 6.41), on the upper surface of which the sex organs appear. Growth in size is, however, limited, and the gametophytes rarely exceed 1 cm (0.4 in.) in diameter and 3 mm (0.12 in.) in height, although much larger forms have sometimes been found.

Culture experiments have shown that there are two different kinds of gametophyte. About half the gametophytes of a mass sowing of spores

remain small and produce only antheridia; very few, if isolated, continue to grow and produce archegonia. The remaining gametophytes are larger and longer-lived. They first produce archegonia, and then, if none is fertilized, a crop of antheridia, followed by another of archegonia. Such gametophytes may last at least two years and in favorable circumstances produce several sporophytes. There is thus some evidence that *Equisetum* is heterothallic, but, since the proportions of the two kinds of gametophyte are related to the density of sowing and other cultural conditions, the differences in behavior cannot have a simple Mendelian basis. Chance variations in the cytoplasmic complements of the spores, leading to differences in competitiveness, may influence somatic growth and subsequent sex expression.

The antheridia of *Equisetum*, like those of the Lycopodiales, contain numerous spermatocytes. They open by the parting of the cover cells and the spermatocytes are discharged. Each is furnished with a number of long fibrils, an interesting parallel to the elaters attached to the spore. The flagella of the enclosed spermatozoids soon become active and the spermatocytes break open, releasing the gametes. Each is about $20\ \mu\text{m}$ long and is twisted into a left-handed screw of three gyres, with an apical crown of about 100 flagella. The ultrastructure is similar to that of other archegoniate male gametes, and a ribbon of microtubules adjacent to the nucleus is a prominent feature. The spermatozoid swims at about $300\ \mu\text{m}\ \text{s}^{-1}$ in a helicoid path. The archegonia are formed mostly between the aerial lobes of the gametophyte. The necks project, and at maturity the four distal cells become elongated and reflexed. The mature egg cell contains abundant amyloplasts, a feature shared with the egg cells of primitive, but not recent, ferns (p. 205). Fertilization, dependent, as in the Lycopodiopsida, upon the presence of a film of water, is followed by the division of the zygote in a plane perpendicular to the axis of the archegonium. The subsequent embryogeny is exoscopic, and the products of the outer cell give rise to the stem apex, the primordium of the first whorl of leaves, and, in a variable lateral position, a root apex.

The development of the young sporophyte

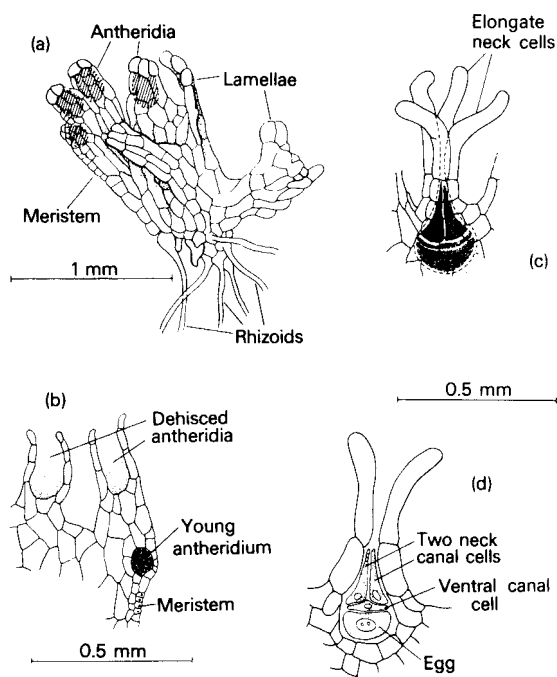

Figure 6.41 *Equisetum sylvaticum*. (a) Young male gametophyte. (b) Section through male branch. (c,d) *E. palustre*, archegonia: (c) general view; (d) longitudinal section. (After Duckett, 1968. PhD dissertation, University of Cambridge.)

follows a curious course (Fig. 6.42), without parallel in other living archegoniate plants. The first axis, which contains a simple protosteles, is of determinate growth and never increases in diameter. In *E. arvense*, for example, it produces about six whorls, each of about three leaves. As this shoot ceases to grow, a bud grows out from below the first whorl of leaves. This also produces an upright axis, of slightly greater diameter than the first and containing a protosteles that shows a tendency toward medullation. This process is repeated two or three times until the axis reaches the diameter and structure characteristic of the mature plant. The rhizomatous growth habit is then initiated. The primary root of the embryo persists only a short time, and roots are produced freely from the nodes at and below the soil surface as the young plant becomes established.

Origin of the Equisetopsida

The bearing of the leaves or branches in whorls, and the articulate structure of the stem, although

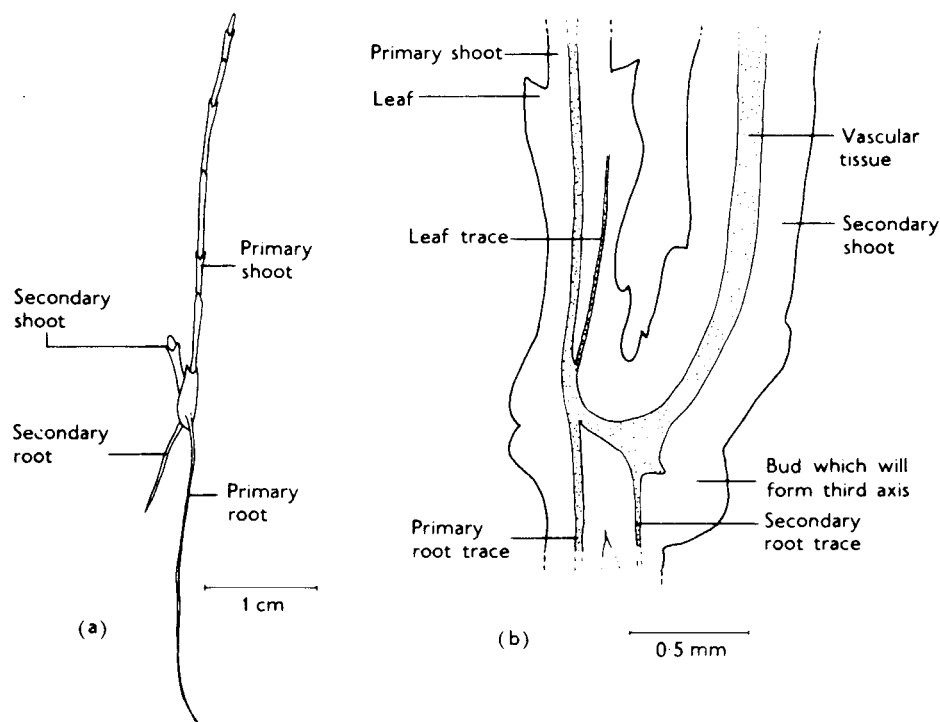

Figure 6.42 *Equisetum arvense*. (a) Sporeling. (b) Development of mature form of plant. (After Barratt. 1920. *Annals of Botany* 34.)

characteristic features of the Equisetopsida, are not of course confined to this class of the plant kingdom. They are present in some of the algae (e.g., *Draparnaldia* (p. 48), *Batrachospermum* (p. 33)) and in the flowering plants (e.g., *Galium*, *Casuarina*), and have clearly arisen a number of times in plant evolution. Nevertheless, the Equisetopsida appear to have specialized in this organization of the plant body from their beginnings, and they may even have had a common origin in the remote past. Unfortunately, no fossils are known which show convincingly how the Equisetopsida might have arisen.

Apart from the Cretaceous plants closely resembling living *Equisetum*, referred to earlier, there is evidence of herbaceous forms having also existed in the Paleozoic. *Equisetites hemingwayi*, for example, from the Upper Carboniferous, shows the remains of a fertile shoot very like *Equisetum* in the structure of the cone and order of size. Although in some of the Carboniferous sphenophylls sporangia were produced in association

with bracts, these complexes seem to have no affinity with the lycopodiopsid sporophyll, a reproductive structure, as we have seen (p. 142), well established in early Devonian times. The Equisetopsida may themselves have had a common origin, and the relationships between the Calamitales and the Equisetales are closer than between the other orders. There seems to have been a general tendency toward the sporangiophore becoming peltate, and this may have hindered the evolution of seed-like structures. The almost total elimination of the equisetopsids points to their limitations, which possibly lay principally in the reproductive mechanisms. It is difficult to account for the survival of the Equisetales in preference to the other orders. It may have been because only this order contained herbaceous forms sufficiently adaptable to meet the fluctuating conditions of the Mesozoic.

Cladoxylopsida

Conspicuous amongst the Middle and Upper Devonian floras are the Cladoxylales, comprising a number of genera of which *Calamophyton* and *Pseudosporochnus* are representative. The best examples have been found in Europe, but they are

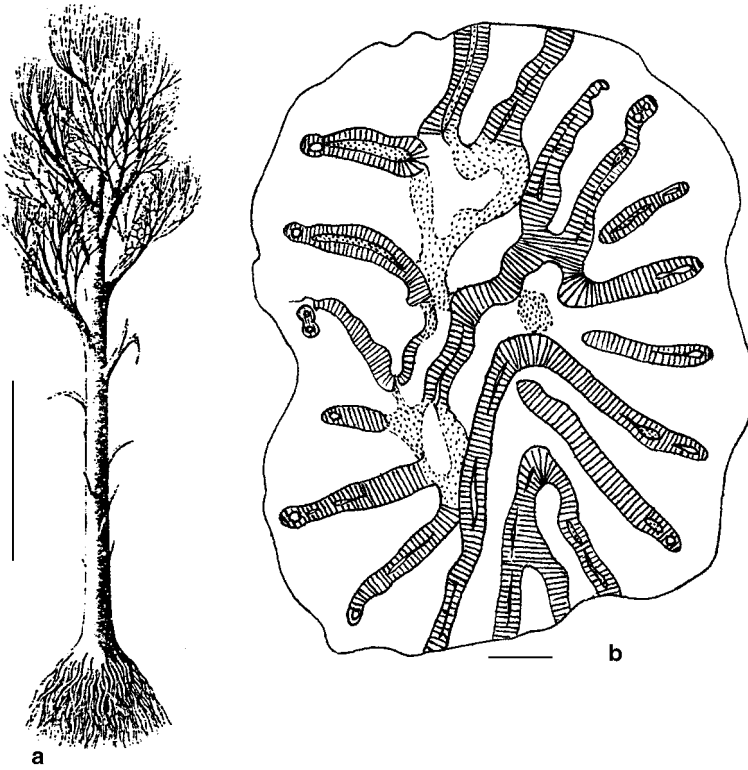

Figure 6.43 Cladoxylopsida. (a) Reconstruction of *Calamophyton*. Scale bar 0.5 m. (b) Section of *Cladoxylon* stem showing highly dissected stele with peripheral loops. Scale bar 1 mm. ((a) after Schweitzer. 1990. *Pflanzen erobern das Land*. Forschungsinstitut Senckenberg, Frankfurt; (b) from Stewart and Rothwell. 1993. *Paleobotany and the Evolution of Plants*, 2nd edn. Cambridge University Press, New York.)

of the laterals. The plant was probably homosporous.

Carboniferous Cladoxylopsida (including *Cladoxylon* itself) are known only as petrifications. They show some of the anatomical characters of the Devonian forms, but until material showing the morphology of the plants becomes available their precise relationship with the Devonian

also known from North and South America. Historically, accounts of the Cladoxylales have been confused, and clear views about their relationships lacking.

Calamophyton (Fig. 6.43a) may prove typical of the group. It possessed a short trunk with an enlarged base from which roots arose. Branches showed digitate to palmate multiple dichotomies. The vascular system consisted of radially directed plates which were variously connected at the center of the axis, and which anastomosed within the branches (Fig. 6.43b). Lateral structures showing simple dichotomy (such as present in *Psilophyton*, Fig. 6.33), reaching 2 cm (0.75 in.) in length, were present along the branches with no obvious regularity. In *Pseudosporochnus*, the distinction between small branches and lateral structures was less clear, some laterals possessing a number of dichotomies and corresponding xylem traces. Ellipsoidal sporangia were borne at the tips

Cladoxylales will remain unclear. The vascular system of *Cladoxylon* consisted of ascending, anastomosing plates of xylem, each in life probably surrounded by phloem and an endodermis. Since the system has the appearance of falling into a number of independent subsystems, it is regarded as polystelic. As in the Devonian forms, the vascular supply to the branches was compound in origin, departing from several of the adjacent ascending plates. A curious anatomical feature was the presence of small parenchymatous areas within the xylem, especially toward the periphery of the stem. Some species of *Cladoxylon* may have had rudimentary secondary thickening.

The Cladoxylopsida have in the past been considered as ancestral to both the Equisetopsida and the Polypodiopsida (ferns). Current concepts suggest that a close relationship with the Equisetopsida is unlikely, but a possible link with the ferns cannot be discounted.

The subkingdom Embryophyta (cont.): division Tracheophyta, Part 2

Polypodiopsida (ferns)

The class Polypodiopsida encompasses both wholly fossil and also living representatives, many of which have a long fossil history. The general features of the class can be summarized as follows:

Sporophyte herbaceous or arborescent, in many forms rhizomatous. Leaves often compound (megaphylls). Vascular system of tracheids and phloem, usually lacking clearly defined secondary tissue. Stele often divided into meristemes. Leaf traces often complex, leaving a parenchymatous gap in the stele at their origin. Sporangia borne on leaves, but never on the adaxial surface of a microphyll. Mostly homosporous; a few (living and fossil) heterosporous. Gametophytes (known only in living forms) simple, usually autotrophic, lacking vascular tissue. Archegoniate. Spermatozoids multiflagellate. Embryogeny typically endoscopic.

The living Polypodiopsida fall into six orders, namely the Marattiales, Ophioglossales, Psilotales, Osmundales, Polypodiales and Hydropteridales, referred to collectively as ferns. Of these, the first three orders are eusporangiate (p. 151), while the Polypodiales, and the Salviniales and Marsileales (p. 212) of the now validated Hydropteridales (p. 216), are leptosporangiate (p. 190). The Osmundales have in general leptosporangiate characteristics, but the sporangia develop in a manner recalling that of eusporangiate sporangia. The ferns are an important element of the world's flora, numbering about 10000 species and being particularly conspicuous in warm humid regions. They show the greatest range of growth forms amongst the vascular archegoniate. Although

largely herbaceous, a number of ferns of the tropics and subtropics (mostly belonging to the family Cyatheaceae) achieve the form and stature of simple trees. *Cyathea* in the Kermadec Islands, for example, has a palm-like habit and reaches a height of 20m (65.5 ft). At the other extreme are minute epiphytes hardly bigger than leafy liverworts (with which they commonly grow). Some families of ferns have a rich fossil record, their distinctive characteristics being recognizable as far back as the Carboniferous (see pp. 179, 211). These ferns are amongst the most ancient of living plants.

A significant feature of many extinct and living Polypodiopsida is the close resemblance, in appearance, development and behavior, between leaves and branch systems. In species of the Carboniferous *Botryopteris* (p. 176), for example, the decumbent fronds gave rise here and there to root and shoot buds. These evidently played a major rôle in vegetative propagation. Similar behavior is seen today in some living ferns (p. 194). In *Stromatopteris*, a rare fern of New Caledonia, it is difficult to distinguish between frond and axis. Similarly, aerial shoots ("fronds") and branches arise from the creeping rhizome of the Psilotales in an almost identical manner. Further, the fronds of the fern *Stromatopteris* and the aerial shoots of *Tmesipteris* (p. 185) are morphologically closely similar.

These stem-like properties of the megaphyll have given rise to the view that it is fundamentally different from the microphyll of the Lycopodiopsida. Its origin clearly lies within the Trimerophytopsida (p. 161) of the Lower Devonian.

The lateral appendages of these early axes appear to have yielded both the reduced leaves of the Equisetopsida (p. 162) and the branching leaf systems of the Cladoxylopsida (p. 171), progymnosperms (p. 218) and ferns. The pinnules of these larger structures presumably arose by the flattening and fusion of the ultimate branchlets. The ferns distinguished themselves from the gymnosperms by remaining largely homosporous, and failing to develop extensive secondary tissues. Although the absence of secondary thickening limited the stature attained by the ferns, they were, nevertheless, an important component of Paleozoic floras.

Extinct orders of ferns

Although it is generally agreed that no true ferns have yet been detected in the Devonian, it seems likely that they share a common origin with other megaphyllous groups within the early Trimerophytosida (see Chapters 6 and 8). Questions remain regarding the relationship of the eusporangiate and leptosporangiate ferns. Some analyses indicate a derivation of the leptosporangiate from the eusporangiate, while others favor a parallel development of both forms from the Zygopteridales.

The Zygopteridales

The Zygopteridales, an order mostly confined to the Carboniferous and regarded as truly fern-like, may have been represented in the Devonian by the remarkable *Rhacophyton* (Fig. 7.1). This was probably a large bushy plant reaching a height of about 2 m (6.5 ft). The main stem, about 2 cm (0.75 in.) in diameter, bore lateral branch systems of two kinds. The sterile were complanately branched leading to a spray of branchlets, appropriately referred to as a frond. The fertile branches had a much more complicated morphology. At each node of the axis of the frond (*rachis*) there were two sterile branches subtended by two densely branched tassels of sporangia. The branching was clearly not in one plane, but quadriseriate. *Rhacophyton* (sometimes given its own order, Rhacophytales) was probably homosporous.

The quadriseriate branching of the frond is characteristic of the Carboniferous zygopterids, of which *Metaclepsydrapsis* is an example (Fig. 7.2). The

vascular system of the stem of the zygopterids was commonly a protostele, often with a parenchymatous medulla. The fronds, which were usually in a recognizable phyllotactic spiral, received a single vascular trace which assumed in the petiole a definite and characteristic symmetry. Consequently the genera and species of these ferns are largely based upon the profile of the leaf trace in transverse section. In *Metaclepsydrapsis*, for example, the section was hour-glass-shaped (clepsydriform). The protoxylem lay toward each pole, each group associated with an island of parenchyma. Pinna traces arose from each pole in alternate pairs, in register with the quadriseriate branching. In *Stauropteris* (sometimes separated in the Stauropteridales), where the frond was similarly constructed, the rachis contained four groups of tracheids ascending in parallel. Well-defined phloem with elliptical sieve areas has been seen in several of these petrified leaf traces. In several zygopterid fronds there were small branched emergences, each with an exiguous vascular supply, at the base of the rachis and at the sites of branching of the fronds. These are referred to as *aphlebiae* (Fig. 7.2), and occur in some living ferns (e.g., *Hemitelia* and other tree ferns).

Although metaxylem tracheids in radial rows are occasionally seen in zygopterid stems, it is doubtful whether these were produced by cambial activity. As in living ferns secondary activity seems to have been absent.

The sporangia of many zygopterids were massive (often reaching or exceeding 2.5 mm (0.1 in.) in length) and presumably eusporangiate (p. 151) in origin. In many forms (but not in *Rhacophyton*) a distinct annulus of thickened cells interrupted by a thin-walled stomium is visible. Homospory appears to have been general, but an example of heterospory was possibly provided by the Carboniferous *Stauropteris burntislandica*. The sporangia (Fig. 7.3) of this species (known as *Bensonites*), which were parenchymatous at the base, produced only one tetrad, consisting of two large and presumably functional spores about 200 μm in diameter, with two small, possibly abortive, spores lying between them. Interpretations of *Bensonites* as indicative of heterospory depend, however, upon the assumption that reproduction of the parent was normal. A triploid form of living



Figure 7.1 Reconstruction of *Rhacophyton ceratangium*. (A) Spiral arrangement of fronds. Oval areas (as at the arrow, f) represent the position of fertile structures. Scale bar 20 cm. (B) Detail of primary pinna. (From Stewart and Rothwell, 1993. *Paleobotany and the Evolution of Plants*, 2nd edn. Cambridge University Press, New York.)

Isoetes (p. 159), *I. coromandelina*, has been found to produce spore tetrads similar to those of *Bensonites*. Two of the spores, however, lack nuclei. Apparently, after the first division of meiosis the nucleus fails to divide again, but the mother cell continues to form a tetrad, resulting in two of the products being anucleate. A similar mechanism may have produced *Bensonites*. It would not be legit-

imate to assume that triploidy, and subsequent meiotic irregularities resembling those in *I. coromandelina*, were not already represented in the Paleozoic pteridophytes. Although the existence of regular heterosporous reproduction in *Stauropteris burntislandica* may therefore be doubtful, it is striking that a similar form of apparent megaspority (although the two accompanying smaller spores were not detected) was found in an earlier zygopterid, *Gillespiea*, from the Upper Devonian of Virginia. This may, of course, have been an early example of dyad formation, accompanied by the omission of the second division of meiosis, an irregularity not uncommon in living free-sporing archegoniates, and possibly of ancient origin.

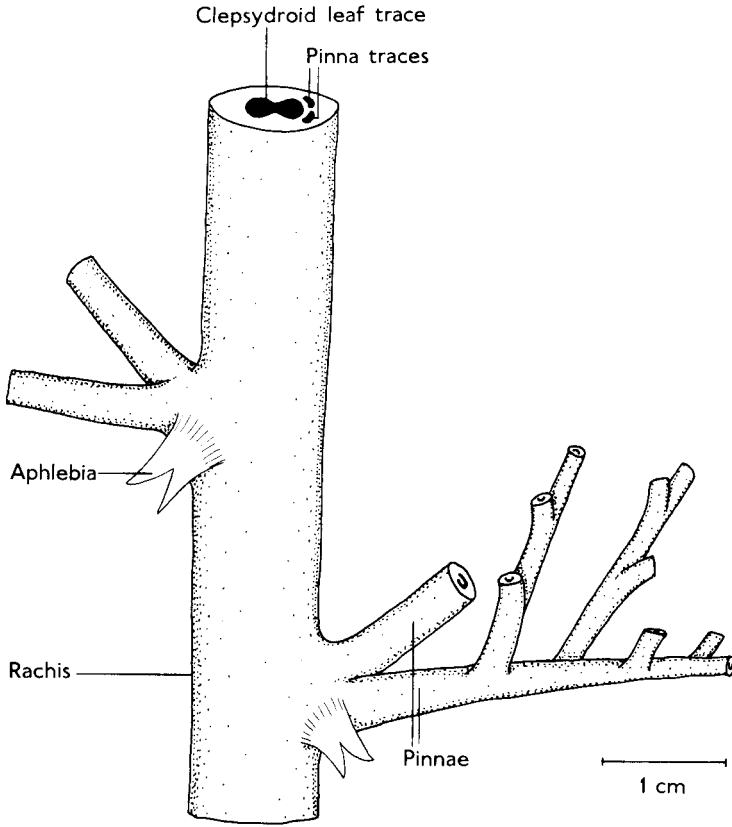

Figure 7.2 *Metaclepsydropsis*.
Reconstruction of portion of frond showing quadriseriate arrangement of pinnae. The stem was rhizomatous.

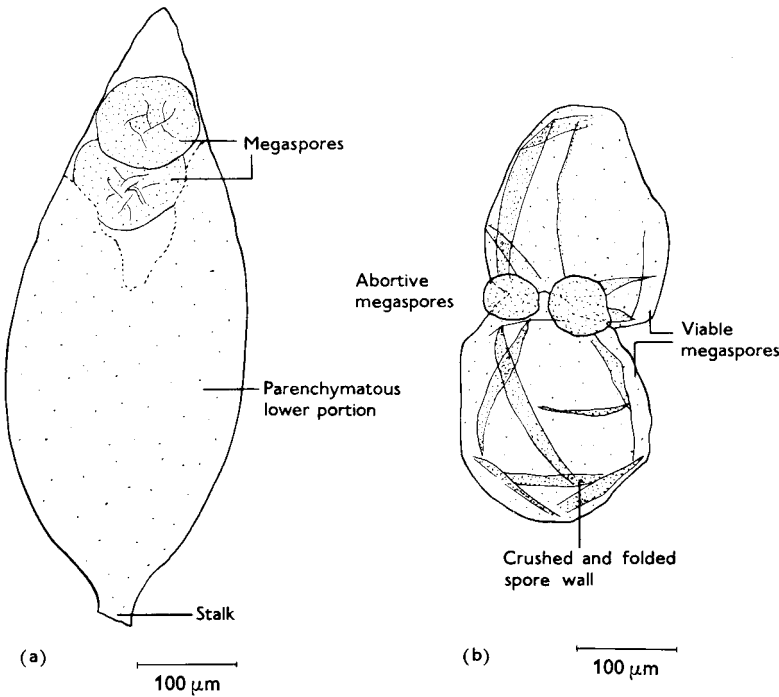

Figure 7.3 *Stauropteris burntislandica*. (a) Megasporangium (from a specimen in the Oliver Collection, Natural History Museum, London). (b) An isolated tetrad (*Bensonites*). (After Chaloner, 1958, *Annals of Botany (New Series)* 22.)

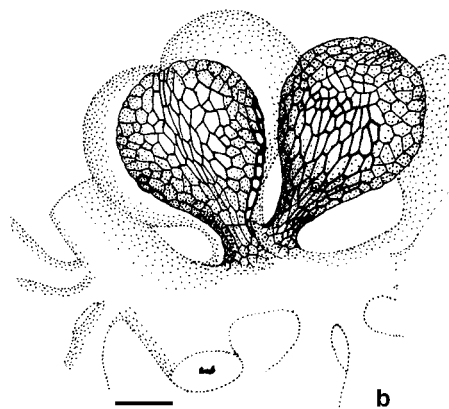

Figure 7.4 *Botryopteris forensis*. (a) Reconstruction of a plant growing as an epiphyte on *Psaronius* (Fig. 7.11). Scale bar 10 cm. (b) Sporangia. Scale bar 1 mm. (Both from Stewart and Rothwell, 1993. *Paleobotany and the Evolution of Plants*, 2nd edn. Cambridge University Press, New York; (b) after Galtier, 1971. *Naturalia Monspelienis Botanique* 22.)

In a species of the Carboniferous *Stauropteris*, believed to be homosporous, spores germinating in a manner typical of living ferns have been found petrified within sporangia. Apart from a few isolated instances of this kind, nothing further is known of the gametophytic phase of the zygopterids.

The Coenopteridales

With the exception of those forms clearly referable to families still existing, the remainder of the Carboniferous ferns are placed in the Coenopteridales. As in the zygopterids, the fronds of the coenopterids were often highly branched and spreading, but the symmetry remained complanate as in the frond of a living fern. Genera are again defined by the shape of the leaf trace. In *Botryopteris*, for example, the trace was ω -shaped in transverse section, the convexity of the curvature being abaxial and the protoxylem lying at the tips of the adaxial extensions. In *Tubicaulis*, by contrast, the trace was C-shaped, the convexity of the

curvature being adaxial. Where known, the vascular system of the axis appears to have been a protostele lacking secondary thickening. Some species of *Botryopteris* probably formed sprawling clumps, with decumbent branches rooting at intervals. Others (Fig. 7.4a) were epiphytes, as were species of *Tubicaulis*.

The sporangia of the coenopterids (Fig. 7.4b) were less massive than those of the zygopterids, and may have been leptosporangiate (p. 190) in origin. The wall was a single cell thick and furnished with a simple terminal opening mechanism similar to that of *Osmunda* (p. 190). They were often attached to pinnules, either near the margin or superficially. The spores were trilete, often with finely decorated exines, 40–70 μm in diameter. There have been no indications of heterospory.

The zygopterids and coenopterids persisted until the close of the Paleozoic era, but so far as known are absent from the Mesozoic.

Existing orders of ferns

The Marattiales

This small order of ferns is wholly tropical. Although not conspicuous in contemporary vegetation, they have a remarkably rich fossil record, and marattialean ferns have been recognized with certainty as far back as the Carboniferous.

Of the living genera, the most common are *Angiopteris* and *Marattia*. Both have short upright trunks bearing large, pinnately branched and



Figure 7.5 *Angiopteris evecta*. Specimen in Las Cruces Botanic Garden, Puerto Rico. (Photograph provided by C. Jermy, Natural History Museum, London.)

rather fleshy fronds (Fig. 7.5), sometimes reaching a length of 5 m (16.5 ft), and showing circinate vernation (i.e., the fronds expand from a closely coiled immature state). At the base of the petiole are two prominent stipules which persist after the leaf has fallen. *Christensenia*, a monotypic genus of the Indo-Malayan region, has a creeping rhizome with palmately divided fronds, which have the distinction of containing the largest stomata known in the plant kingdom. *Danaea*, a small genus confined to tropical America, has one species with a simple, ovate frond, and another with a small pinnate frond in which the lamina is pellucid and filmy. These forms, although revealing the diversity in the fronds of the Marattiales, are nevertheless unusual, and a massive angular construction is characteristic of the fronds of the Marattiales as a whole. The laminae normally

show differentiation into palisade and mesophyll, with the stomata confined to the lower surface.

The stems of the upright forms usually grow not from a single apical cell (as in most ferns) but from a more massive meristem. The leaves form an apical crown, and since each receives an extensive trace, consisting of several strands of vascular tissue, the form of the stele is highly complex. A transverse section of the stem shows a number of concentric cycles of partial steles (*meristeles*), and dissection reveals that the meristeles of each cycle anastomose freely, occasional anastomoses also occurring between adjacent cycles. Leaf traces originate from the outer cycle of meristeles. Root traces, which may arise at any depth, pass out obliquely into the cortex. An endodermis, although present in young plants, is usually absent from the stelar regions of the older.

Tapering tracheary elements with long scalariform perforation plates have been observed in the xylem of stems and roots of a number of Marattiales. These can justifiably be regarded as vessels. The stems of the Marattiales as a whole contain little if any sclerenchyma, but there is an abundance of mucilage canals and tannin sacs, as elsewhere in the plant (Fig. 7.6). These indicate a particular kind of carbon metabolism that seems to have been widespread amongst the ancient ferns.

REPRODUCTION

The fertile fronds resemble the sterile in most genera, and the sporangia, always eusporangiate in origin, are confined to the lower surface. In *Angiopteris* they arise in two ranks beneath veins toward the margins of the pinnules (Figs. 7.7a and 7.9a). The group of sporangia is referred to collectively as a *sorus*. Dehiscence of the sporangia, along a longitudinal stomium, is directed toward the mid-line of the sorus (Fig. 7.9a). In *Marattia* the fertile regions are similar, but the sporangia are congenitally fused into a *synangium* (Figs. 7.7b, 7.8 and 7.9b). As the synangium matures and dries, it splits longitudinally into two valves (Fig. 7.9b), and each compartment dehisces by a pore in the inner face. The number of spores in each sporangium (or synangial compartment) in the Marattiales reaches 1000 or more.

Given warmth, moisture and light, the spores

Figure 7.6 *Angiopteris evecta*.
Transverse section of secondary
rachis.

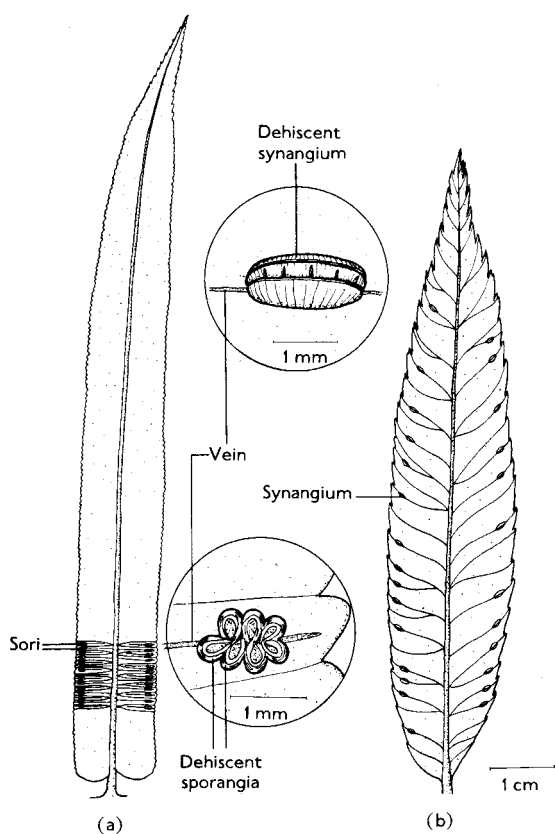
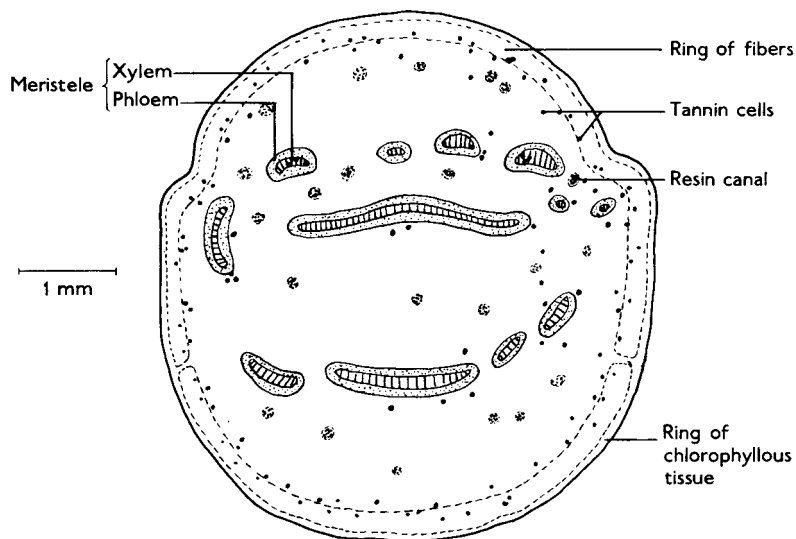

Figure 7.7 Fertile pinnules of the Marattiales. (a)
Angiopteris. (b) *Marattia*.

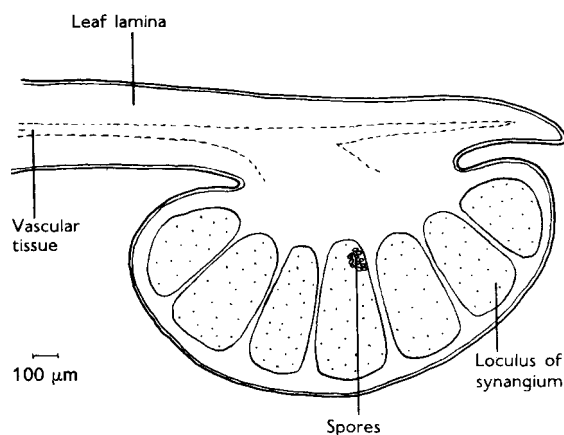

Figure 7.8 *Marattia*. Vertical section of synangium.

germinate rapidly, and after passing through a brief filamentous phase generate a green thalloid gametophyte with apical growth, resembling a thallose liverwort such as *Pellia*. Although autotrophic, the lower cells contain an endophytic, and presumably mycorrhizal, fungus. The gametophyte can be long-lived and old specimens reach a length of 3 cm (1.4 in.) or more. The antheridia are sunken, and occur on both surfaces, but the archegonia, also sunken, are confined to the median region of the ventral surface. The protrud-

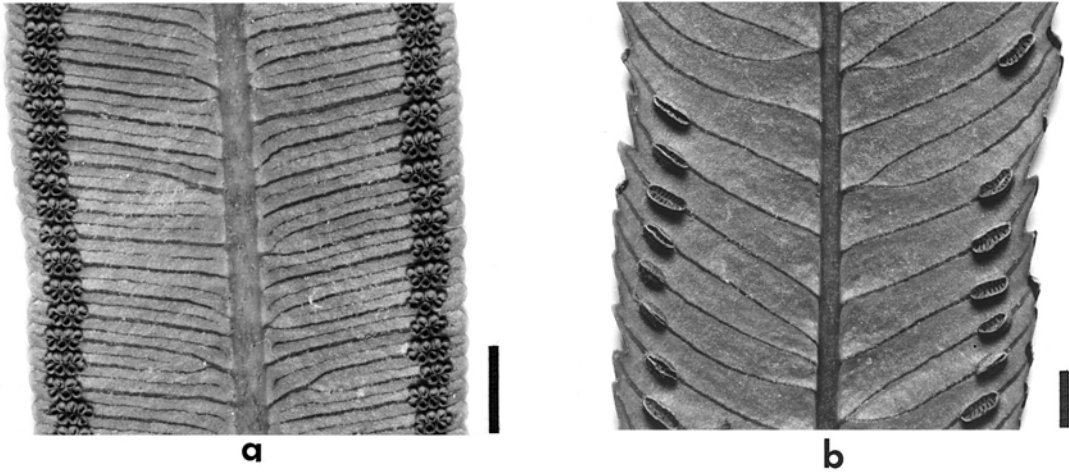

Figure 7.9 (a) *Angiopteris evecta*. The abaxial surface of a fertile pinnule showing the grouping of the sporangia into sori, and the arrangement of the sori. The sporangia have dehisced. (b) *Marattia fraxinea*. The abaxial surface of a fertile pinnule showing the arrangement of the synangia. The synangia have dehisced. Scale bars 2.5 mm.

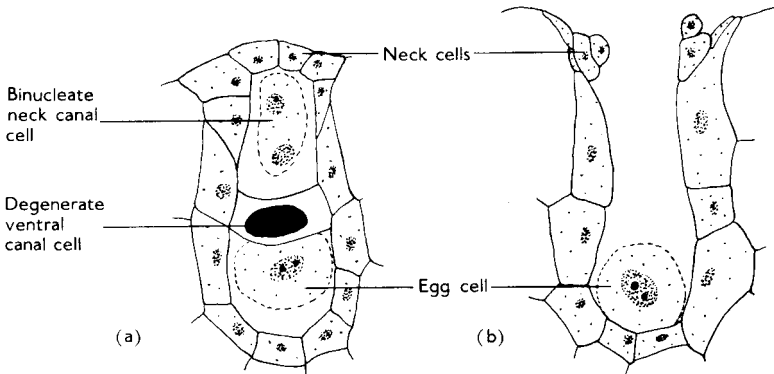

Figure 7.10 *Angiopteris evecta*. Vertical section of archegonium. (a) Immature. (b) Prior to fertilization. (After Haupt, from Foster and Gifford. 1959. *Comparative Morphology of Vascular Plants*. Freeman, San Francisco. ©1959.)

ing neck cells form little more than a cap over the ventral canal (Fig. 7.10).

The first division of the zygote is by a wall transverse to the longitudinal axis of the archegonium. The subsequent embryogeny is endoscopic, and the embryo often emerges from the upper side of the gametophyte. A suspensor has been reported in *Danaea*, but is elsewhere lacking.

Vegetative propagation of *Angiopteris* in glasshouses is achieved by culturing the massive stipules in peaty soil. In these conditions they will give rise to one or more shoot buds. Asexual reproduction of this kind may occur sporadically in nature.

FOSSIL HISTORY

The Marattiales are represented in the Carboniferous period by both vegetative and fertile material. *Psaronius*, for example, is the remains of a trunk surrounded by a mantle of descending roots (Figs. 7.11 and 7.12). The vascular tissue, which was wholly primary, formed a poly-cyclic array of anastomosing, band-like meristeles. Morphologically and anatomically *Psaronius* is so suggestive of an arborescent *Angiopteris* that there seems little doubt of its affinity. Fronds of *Psaronius* are encompassed by the genus *Pecopteris*, while fertile material is represented by *Scoleopteris* (Fig. 7.13) and *Eoangiopteris*, the

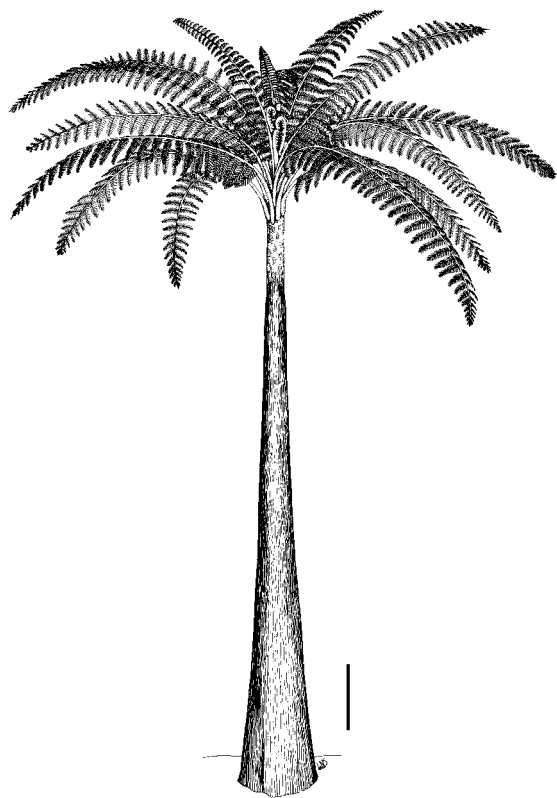

Figure 7.11 *Psaronius*, reconstruction. Scale bar 25 cm.
(From Morgan. 1959. *Illinois Biological Monographs* 27.)

sporangia of which were very similar to those of *Angiopteris*, although there were minor differences in the sorus. Fertile fronds of marattialean ferns, resembling those of various modern genera, are also found throughout the Mesozoic.

The Ophioglossales

The Ophioglossales form a small, and morphologically peculiar, order of living ferns which, since they have no well-established fossil record, are of obscure origin. In all members the fertile region of the frond takes the form of a spike or pinnately branched structure, clearly set off from the vegetative portion. A feature that separates the Ophioglossales from other living ferns is that the fronds, instead of showing circinate vernation (see p. 177), grow marginally from a more or less flat primordium. That of *Botrychium lunaria* when young shows a distinct kind of folding, the upper margins of the pinnules being covered by the lower margins of the pinnules above.

Of the three genera of the class, *Botrychium* (moonwort) and *Ophioglossum* (adder's tongue) (Fig. 7.14b) are fairly widespread, the former mainly in the north temperate zone and the latter chiefly in the tropics. Both genera include species native to the British Isles. The third genus, *Helminthostachys* (Fig. 7.15), is restricted to the Polynesian Islands in the South Pacific and a few regions in the Asian tropics, but is often locally abundant along roadsides. In parts of rural India the young frond is used as a vegetable.

Figure 7.12 *Psaronius conjugatus*.
Transverse section of stem. From a specimen in the Oliver Collection
(Natural History Museum, London).

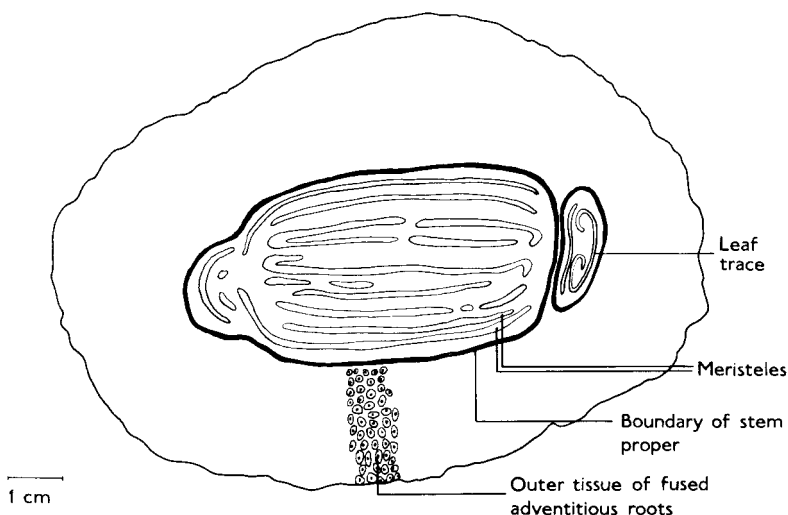

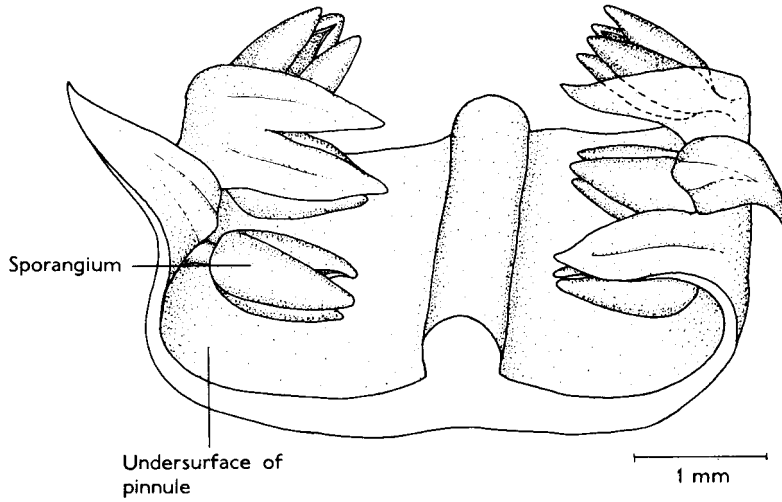

Figure 7.13 *Scoleopteris incisifolia*. Reconstruction of portion of fertile pinnule. (After Mamay, from Andrews, 1961. *Studies in Paleobotany*. Wiley, New York.)

In *Botrychium* (Fig. 7.14a), where the frond is annual, the vegetative and fertile parts are pinnately branched. *Helminthostachys* is basically similar, but the branches of the fertile part of the frond are very contracted (Fig. 7.15). In *Ophioglossum* (Fig. 7.14b) the sterile part of the frond, which is reticulately veined, is elliptical and entire or, in a few epiphytic forms, dichotomously lobed. The fertile part is usually a simple unbranched spike.

THE VASCULAR SYSTEM OF THE RHIZOME
The Ophioglossales are rhizomatous, growth taking place from a single apical cell. In *Botrychium* the rhizome of the young plant contains a medullated protostele (Fig. 7.16), but in the stele of older plants a parenchymatous area perforates the xylem anterior to the departing leaf trace. The endodermis remains wholly exterior. We thus arrive at a stele intermediate between a protostele and a solenostele, often referred to as a siphonostele (see Fig. 7.28). A rudimentary solenostele does in fact arise in some species of *Botrychium* as a result of an endodermis appearing on the inside of the xylem cylinder. The stele shows a number of points of anatomical interest. The metaxylem tracheids, for example, bear bordered circular pits, found outside the Ophioglossales only in the gymnosperms and angiosperms. There is also limited cambial activity leading to some secondary xylem, otherwise unknown in living ferns. Apart from this feature, the anatomy of *Ophioglossum* and *Helminthostachys* resembles that of *Botrychium*.

The roots of all Ophioglossales tend to be fleshy. The central vascular strand is either diarch or, in the larger roots, polyarch. Many species of *Ophioglossum* form vegetative buds on the roots.

Figure 7.14 (a) *Botrychium lunaria*, habit. (b) *Ophioglossum vulgatum*, habit. Scale bar 2 cm. (After Lowe, 1874–78. *Our Native Ferns*. Groombridge, London.)

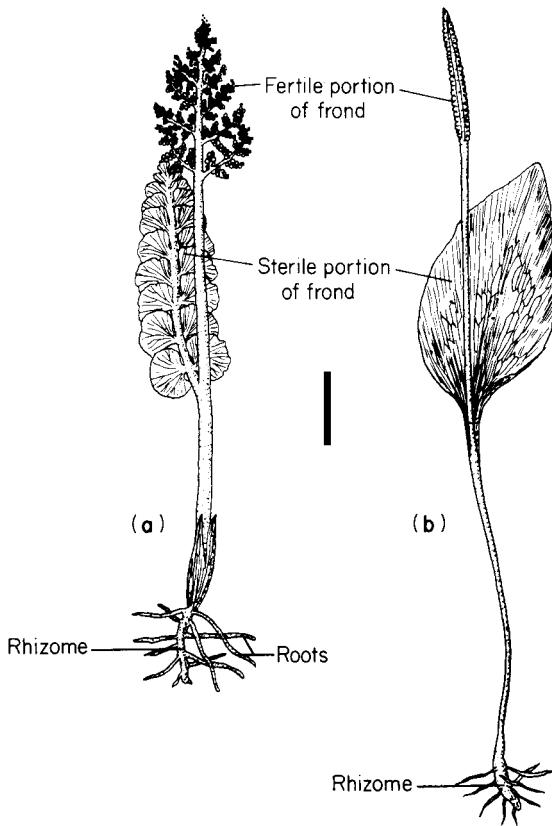

Figure 7.15 *Helminthostachys*.

Upper part of plant showing fertile spike. Scale bar 5 cm.

(Photographed in Sri Lanka by R. D. E. Jayasekera.)



REPRODUCTION

The spherical sporangia of *Botrychium*, eusporangiate in origin, arise in two ranks on the ultimate branches of the fertile part of the frond. The spore mother cells are enclosed in a tapetum, several cells in thickness, in whose disintegration products the spores mature. Even at maturity the wall of the sporangium is massive, and stomata interrupt its outer layer. The spores, a few thousand in number, are released by transverse dehiscence. *Botrychium*, like the Ophioglossales as a whole, is homosporous.

The gametophyte of *Botrychium* is a flattened tuberous prothallus, subterranean and invested with an endophytic fungus, presumably in mycorrhizal relationship (Fig. 7.17). Gametophytes have also been raised in pure culture, but germination is poor unless the spore walls are first abraded by shaking with sand. A period of darkness is also essential for satisfactory germination, although following germination the gametophytes will grow in the light. Chlorophyll remains absent and sugar is essential for successful growth. The antheridia are sunken, and each yields over 1000

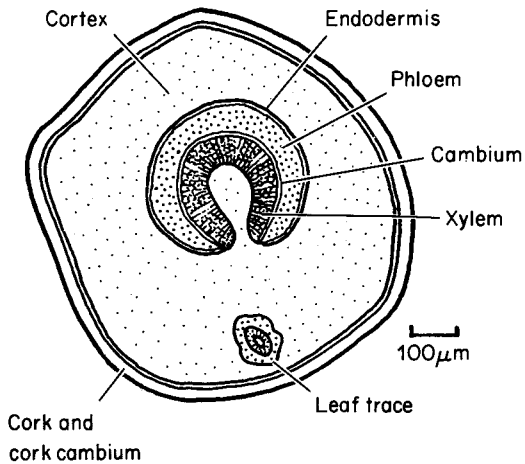

Figure 7.16 *Botrychium lunaria*. Transverse section of rhizome.

multiflagellate spermatozoids. The archegonia, of quite normal construction, are partially immersed. The embryogeny of *Botrychium* is somewhat variable: in some species there is a suspensor and development is endoscopic, in others the suspensor is lacking and the development exoscopic. The first organ to emerge is the root, infected from the first with the same endophytic fungus as the gametophyte. The young plant may remain subterranean in an immature condition for several years. Some individuals may even become green and complete their life cycle while remaining covered by litter. Permanently albino forms are also known, but the inheritance of this condition has not been studied. It seems that photosynthesis plays a minor rôle in the metabolism of *Botrychium*, nutrition being, in some forms at least, provided entirely by the mycorrhizal fungus. Despite the gametophyte being subterranean, interspecific hybrids of *Botrychium* are known and sometimes locally frequent.

The reproduction of *Helminthostachys* is similar to that of *Botrychium*, but the dehiscence of the sporangia is longitudinal, and the embryogeny is regularly endoscopic. In *Ophioglossum* the sporangia, which occur as two rows partially embedded in the spike (Fig. 7.18), open by transverse clefts. Those in the central region of the spike mature first. Each contains numerous spores, in some species of the order of 15000. The gametophyte of *Ophioglossum* is subterranean and cylindrical,

sometimes approaching 5 cm (2 in.) in length. Both antheridia and archegonia are sunken. The embryogeny is exoscopic.

Asexual reproduction by means of root buds is well known in *Ophioglossum*, sometimes leading to stands of a species more rapidly than sexual reproduction. Cleared lands in New Guinea, for example, were observed to become rapidly colonized by large populations of *Ophioglossum* derived almost entirely from root buds. Some species of *Botrychium* produce spherical multicellular gemmae, up to 1 mm (0.04 in.) in diameter, from meristematic regions of the cortex of the rhizome. On abscission they develop in a manner similar to that of embryos.

PHYLOGENY

The Ophioglossales have no close relatives, and the evidence of distribution and comparative anatomy, particularly in relation to the massive eusporangiate sporangia and the stele, points to their being the relicts of an ancient lineage. The bordered pits of the tracheids, the epiphyllous origin of the fertile regions, and the production of secondary xylem in the rhizome of *Botrychium* have suggested to some that the Ophioglossales are derived from some ancient progymnosperm stock (p. 218), and that there is no close relationship with the polypodialean ferns. The negligible fossil record of the Ophioglossales as a whole suggests that they were never very numerous.

The chromosome numbers of *Ophioglossum* are remarkably high, exceeding 1000 in one species. The living forms may therefore be ancient polyploids.

The Psilotales

This order is represented by two small genera, *Psilotum* (Fig. 7.19a) and *Tmesipteris* (Fig. 7.19b). The former is pan-tropical and not uncommon, but the latter, although locally abundant, is confined to Australasia and Polynesia.

The sporophyte of *Psilotum*, which may be either terrestrial or epiphytic, consists of upright (or, in one epiphytic species, pendulous), dichotomously branching axes arising from a horizontal system of similarly branching rhizomes. The rhizomes bear rhizoids, and contain an endophytic fungus, probably a symbiotic mycorrhizal

Figure 7.17 *Botrychium virginianum*. Vertical section of gametophyte. (After Campbell, 1905. *The Structure and Development of Mosses and Ferns*. Macmillan, New York.)

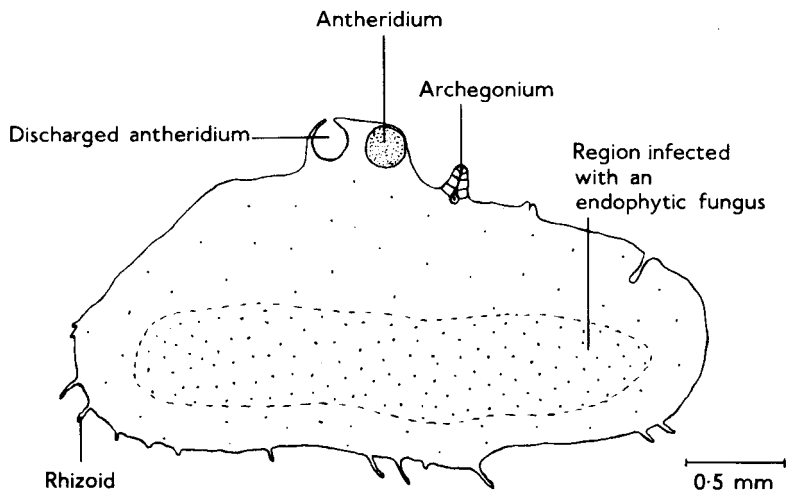
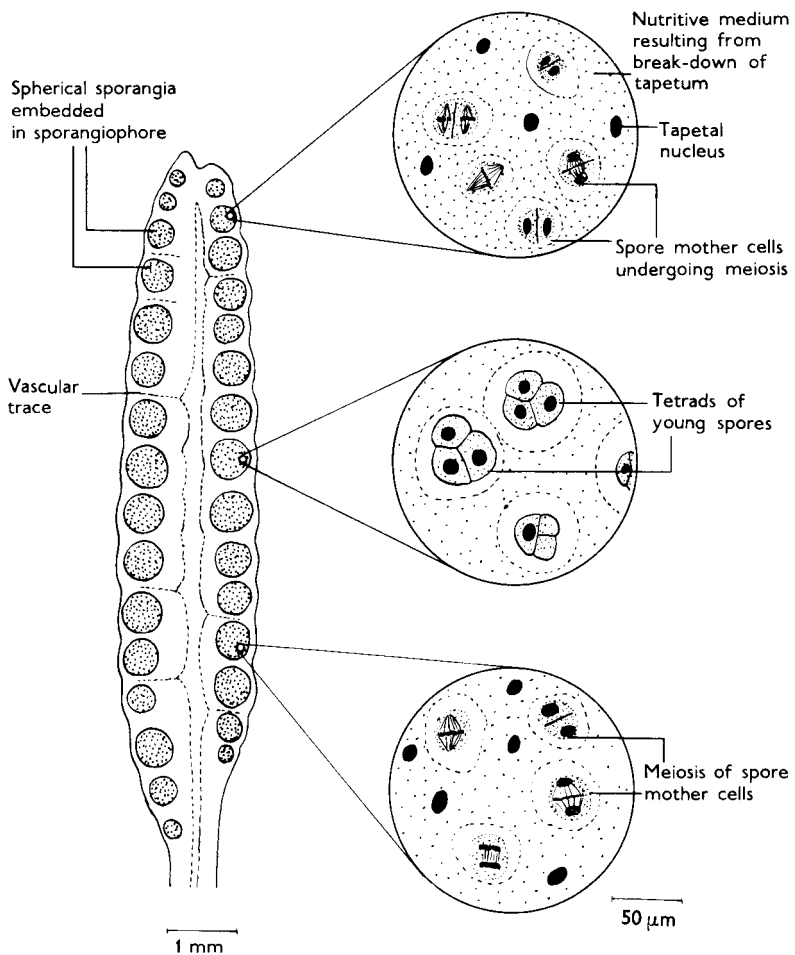

Figure 7.18 *Ophioglossum vulgatum*. Longitudinal section of young fertile spike.



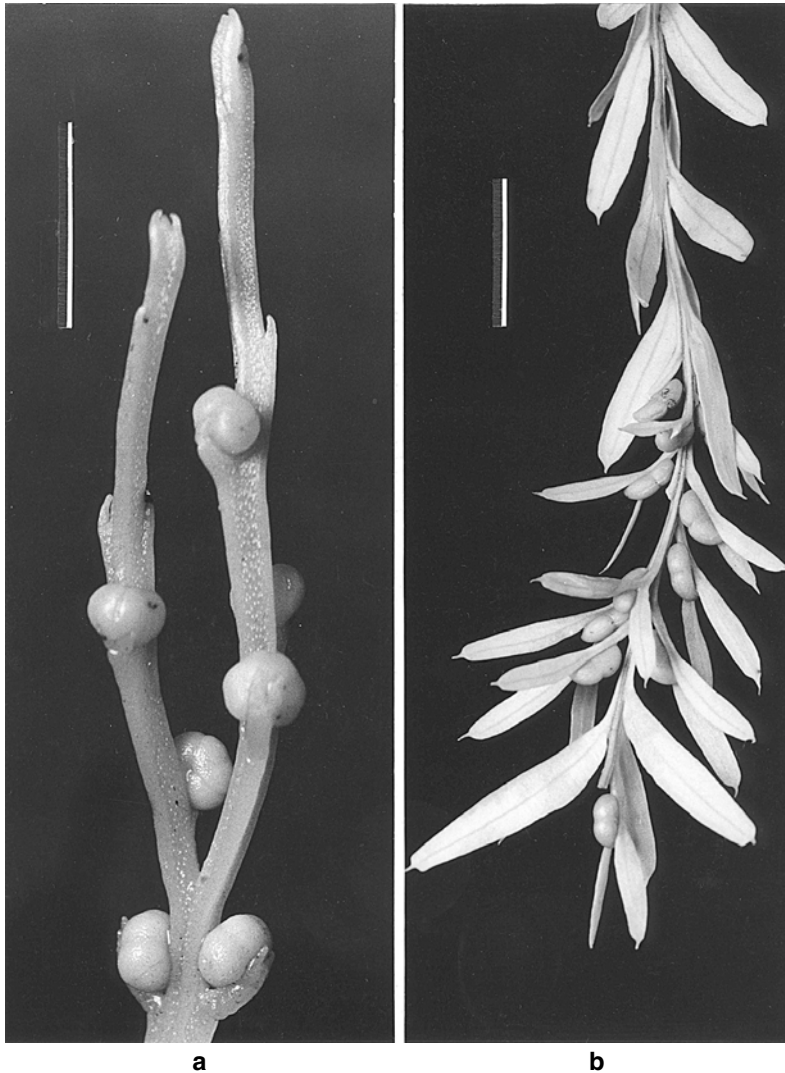

Figure 7.19 (a) *Psilotum nudum*, fertile region. The trilocular sporangia are subtended by small forked bracts. (b) *Tmesipteris tannensis*, fertile shoot. The bilocular sporangia are attached at the forks of conspicuous bifid bracts. Scale bars 0.5 cm.

association. Small scales, which are at first green but soon become scarios, occur at irregular intervals on the aerial stem. They lack a vascular strand, but in one species a strand does approach the base of the scale, but stops below the insertion. Stomata are present, but are confined to the epidermis of the aerial stem.

The aerial stem of *Psilotum* contains a simple stele (protostele), frequently enclosing in the upper regions a central parenchymatous medulla. The xylem, consisting solely of tracheids, is often stellate in transverse section, the arms narrowing and standing opposite poorly defined ribs at the exterior of the stem (Fig. 7.20). The xylem is exarch

in the aerial stems, but tends to be mesarch in the rhizome. Phloem surrounds the xylem, but, apart from the lateral sieve areas, the sieve cells are little different from elongated parenchyma cells. An endodermis, separated from the phloem by a narrow zone of pericyclic parenchyma, marks the boundary of the stele. It forms a usually single-layered sheath around the stele, its cells characterized by the Casparian strip, a band of fatty material embedded in the radial walls. The cells of the inner cortex, adjacent to the endodermis, often contain accumulations of phlobaphene, a condensation product of tannin.

The branches of both the aerial and terrestrial

Figure 7.20 *Psilotum nudum*.

Transverse section of lower part of aerial branch.

systems of the sporophyte grow indefinitely from single or small groups of apical cells. There is no evidence that the dichotomy of the axes follows median longitudinal division of a single apical cell, as in certain algae (e.g., the brown alga *Dictyota dichotoma* (p. 92)).

Tmesipteris is frequently an epiphyte with trailing stems (Fig. 7.19b). The general morphology is similar to that of *Psilotum*, but branching is much less frequent. The appendages are larger and more leaf-like, remaining green and possessing stomata, and also frequently a vascular strand. The insertion of the appendages is, however, peculiar, being longitudinal instead of transverse, so that they appear more as flange-like outgrowths of the axis than as normal foliage leaves.

REPRODUCTION

Spores are produced in the upper region of the sporophyte of *Psilotum* (Fig. 7.19a). The spore-bearing organs, which are distant from each other, are three-lobed, and each is subtended by a bifid appendage. The lobes correspond to three internal chambers (Fig. 7.21), separated by septa, and each filled with spores. It is still not clear whether this spore-bearing organ is to be interpreted as a trilocular sporangium or as a synangium formed by the fusion of three sporangia. Three primordia are, however, visible early in the ontogeny of the organ, perhaps indicating its synangial nature. Since a distinct vascular strand extends into the base of the synangium, it is usually regarded as terminating a lateral axis, rather than arising in association with a sporophyll. This view is strengthened by the existence of a cultivated form, "Bunryu-zan", in which the synangia terminate vertical axes.

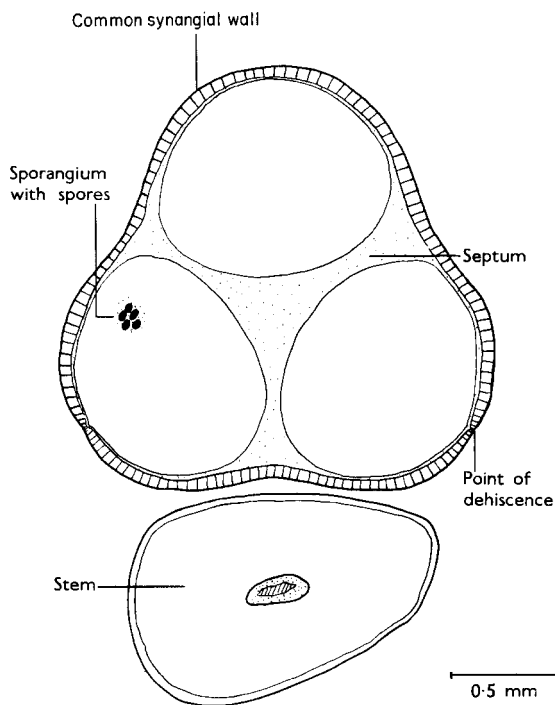
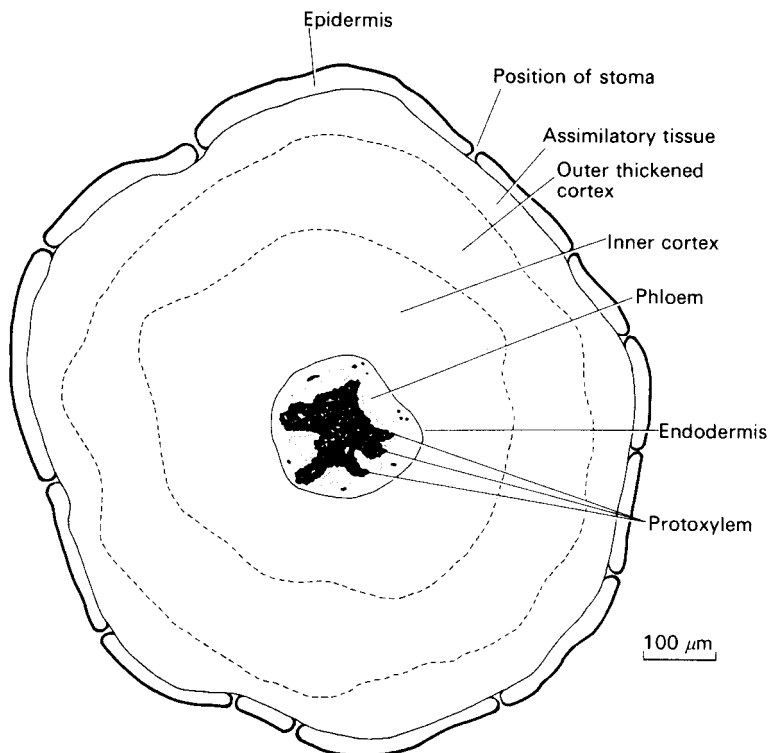

Figure 7.21 *Psilotum nudum*. Transverse section of trilocular sporangium (synangium).

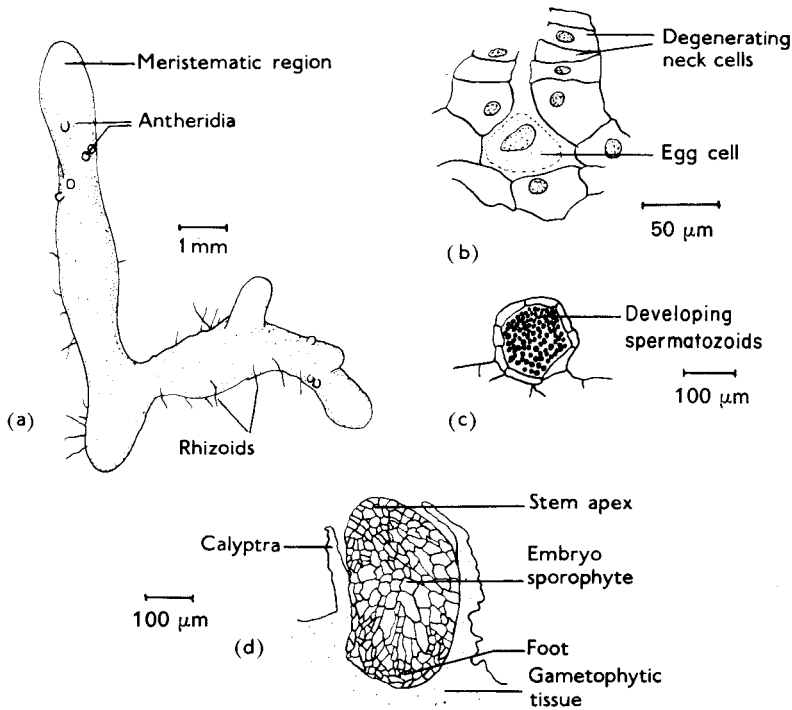

Figure 7.22 *Psilotum nudum*. (a) Gametophyte. (b) Mature archegonium. (c) Antheridium. (d) Young sporophyte. (After Bierhorst, 1953. *American Journal of Botany* 40 and Bierhorst, 1954. *American Journal of Botany* 51.)

zoids. The archegonium has four tiers of neck cells, but at maturity all but the lower one or two tiers degenerate. Fertilization, which depends upon the presence of a film of water, is brought about by spirally coiled, multiflagellate spermatozooids.

The first division of the zygote is in a plane transverse to the longitudinal axis of the archegonium, as in the bryophytes. The outer (or epibasal) cell yields the apex of the

embryo, and the inner (or hypobasal) the foot. The embryogeny is thus exoscopic.

In *Tmesipteris*, spore-bearing organs occur in the upper parts of some of the shoots, each subtended by a bifid appendage (Figs. 7.19b and 7.23). These organs are regarded as synangia terminating very short lateral branches, but in *Tmesipteris* each consists of only two fused sporangia.

The reproduction of *Tmesipteris* is very similar to that of *Psilotum*. The foot of the young embryo of *Tmesipteris* is lobed, and the whole bears a striking resemblance to the young sporophyte of *Anthoceros*. It is doubtful, however, whether this bears the phylogenetic significance that some have claimed.

ORIGIN

The anatomical and reproductive features of the Psilotales recall the Rhyniopsida and Trimerophytopsida of the Paleozoic. There is, however, no continuity in the fossil record, and the origin of the Psilotales remains conjectural. Their generally high chromosome numbers (52–210 in the gametophytic phase) may indicate a complex polyploid series developed with little evolutionary change over geological time, but

Each of the three groups of archesporial cells in the synangium arises from several cells, and is thus eusporangiate in origin. Part of the peripheral archesporium, although not regularly layered, functions as a tapetum. The remainder yields sporogenous cells. Meiosis leads to tetrads of monolete spores. The exine is lightly reticulate with no very distinct ornamentation. The massive wall of the sporangium, some five cells thick at maturity, dehisces at three sites symmetrically placed with respect to the loculi.

The gametophyte of *Psilotum* is a subterranean axial structure (Fig. 7.22), dichotomously branching, and resembling short lengths of the sporophytic rhizome. The similarity extends to the anatomy, the finer axes being wholly parenchymatous, and the broader containing a central vascular strand. The peripheral cells, like those of the rhizome, house an endophytic fungus. Both the gametophyte and the sporophytic rhizome produce globular multicellular gemmae, a means of vegetative propagation.

Antheridia and archegonia arise from superficial cells in the region of the growing points of the gametophyte (Fig. 7.22). The antheridia, depending upon their size, liberate up to 250 spermato-

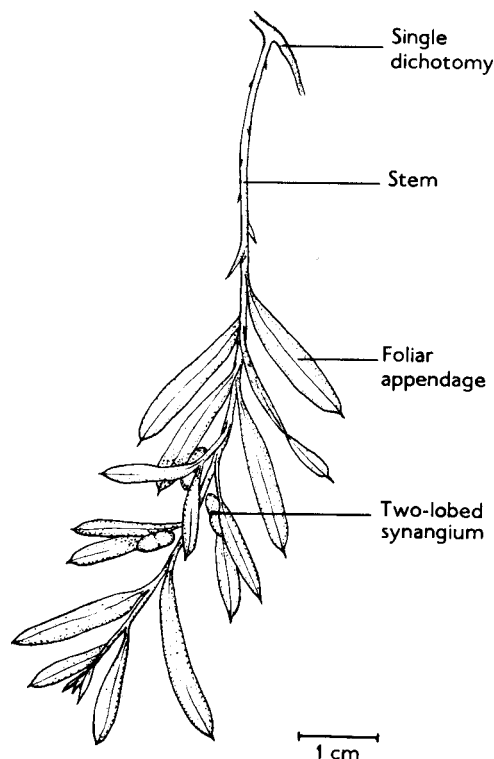

Figure 7.23 *Tmesipteris tannensis*, habit.

evidence of this kind is inconclusive. Similarity, both in sporophyte and gametophyte, between the Psilotales and certain New Caledonian ferns (e.g., *Stromatopteris*, p. 172), together with the results of current cladistic analyses, support a placement of the Psilotales within the Polypodiopsida.

The Osmundales

The Osmundales are an order of considerable antiquity. Their derivation may have been separate from that of other eusporangiate and leptosporangiate ferns. There are three existing genera, of which *Osmunda* is the largest and most widely distributed. Most living Osmundales have erect rootstocks, and some (e.g., *Todea* spp.) approach a small tree-like form. They currently have few economic uses, but partially decomposed petioles and leaves (“*Osmunda* fiber”) was popular in Victorian times as a medium for growing ornamental orchids.

The stem of *Osmunda* grows from a broad apex, and in all but larger and older specimens a single apical cell is recognizable. The stem terminates in

a crown of bipinnate leaves. The pinnules are commonly leathery, but in *Leptopteris*, a fern of New Zealand and New Guinea allied to *Todea*, the lamina is filmy (as in the Hymenophyllaceae, p. 194), a single cell thick and lacking stomata. The leaves of all Osmundales show circinate vernation. The robust leaf bases give considerable support to the stem and in consequence older specimens are able to develop a dendroid form.

Remains of osmundalean ferns, retaining sufficient features to permit firm identification of their affinity, are known from the Upper Permian (late Paleozoic), and the record, supported by preserved axes, fronds and sporangia, continues through the Mesozoic to the present. The stems of early representatives of the Osmundales were protostelic, but in later forms the central part of the stele became replaced by pith, leading to a siphonostele (p. 192). In living *Osmunda* (Fig. 7.24) the stele is basically a siphonostele, and the phloem and endodermis remain wholly external. The continuity of the xylem, however, is broken at the departure of the leaf traces, leaving a so-called “leaf gap” which closes again anteriorly. Since, when dissected, the xylem (but not the stele as a whole) has the appearance of a cylinder of netting, *Osmunda* is said to have a dictyoxylic siphonostele. A transverse section of the stem of the late Permian *Thamnopteris* appears almost identical, even in the extent and arrangement of the sclerenchyma and the packing of the leaf bases, with a comparable section of the rootstock of *Osmunda*.

Some remains of osmundalean ferns can be identified even to species level. Well-preserved specimens from the Upper Cretaceous of Canada have been found to resemble in all respects the living *Osmunda cinnamomea*, still with an extensive range in North America. This is in line with the general impression that species longevity in homosporous pteridophytes commonly exceeds by far that provided by flowering plants.

REPRODUCTION

In *Osmunda* the early leaves are sterile, while later leaves become fertile in the more distal regions (Fig. 7.25). The fertile regions are devoid of chlorophyll. The sporangia arise from single initial cells which may be cubic or tetrahedral. More than one

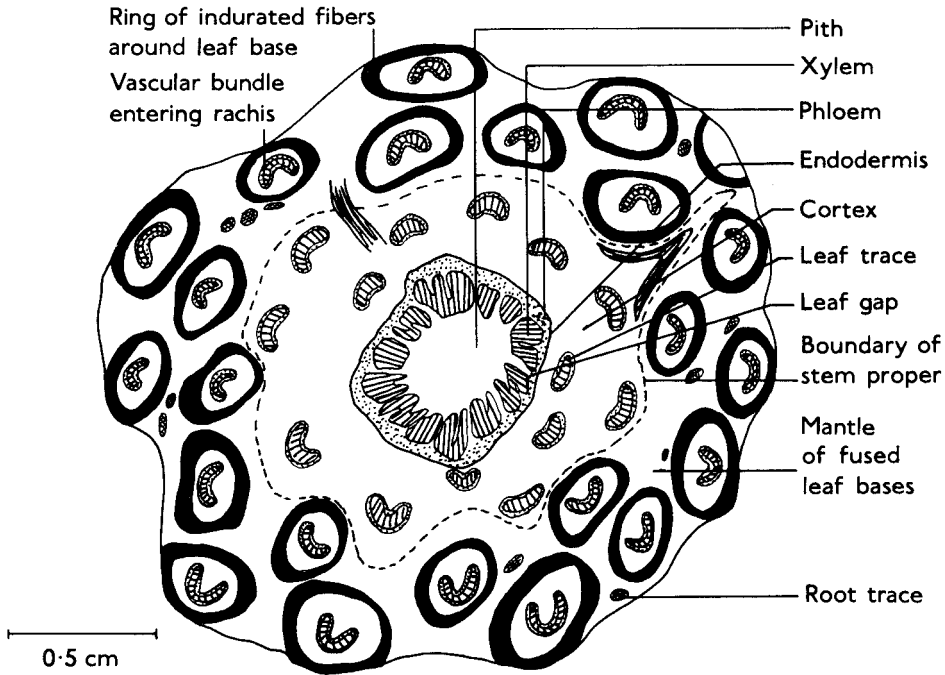

Figure 7.24 *Osmunda regalis*. Transverse section of rootstock.

cell may participate in the development of the sporangium, so they are neither strictly leptosporangiate nor eusporangiate. At maturity the sporangia are generally robust and each is borne on a short stalk. The sporangia do not cluster in sori, nor is there any form of protective membrane (indusium, p. 198). The wall of the sporangium is two cells thick, although the inner layer, together with the tapetum, is derived from the sporogenous tissue. In *Osmunda* the indurated cells, forming an annulus-like cluster, are grouped laterally (Fig. 7.26). A linear stomium extends from the cluster over the apex of the sporangium, causing the dehiscent sporangium to open as two valves. Some 2^9 trilete spores are produced in each sporangium. They are green when released, and soon lose their viability in unfavorable conditions.

The gametophytes of the Osmundales are *Marchantia*-like, with a distinct midrib, and may reach a length of a few centimeters. The antheridia are on the lower surface, often toward the margin. The archegonia, also on the lower surface, are found principally along the sides of

the midrib. Following fertilization, the first division of the zygote is in a plane parallel to the longitudinal axis of the archegonium. The second division may also be parallel to the longitudinal axis, but at right angles to the plane of the first, leading to quadrants with a common edge parallel to the axis. This contrasts with the common situation in the leptosporangiate ferns (p. 207).

Subsequent divisions tend to be irregular and the embryo assumes a globular form. In *Todea*, the young embryo can be expressed from the archegonium by gentle pressure. Attempts to grow it to maturity in artificial media have not, however, been successful; any growth obtained has tended to revert to gametophytic form.

The Polypodiales

The Polypodiales form the largest order of ferns, including (with the exception of some Ophioglossales and Osmundales) all the homosporous ferns of temperate regions. The Polypodiales reach their greatest representation in the humid tropics and subtropics. A square hectare of forest in Amazonian Ecuador, for example, was estimated to contain at least 50 species of polypodialean ferns of widely varying growth forms. Despite the diversity of the

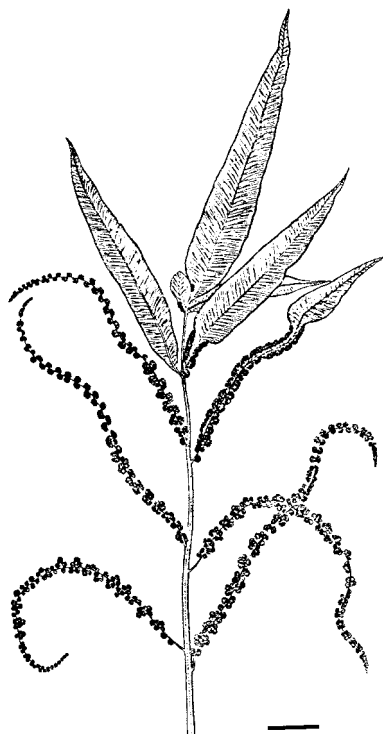

Figure 7.25 *Osmunda javanica*. Portion of frond with fertile pinnules. Scale bar 4 cm. (From Backer and Posthumus. 1939. *Varenflora voor Java*. Buitenzorgs Lands Plantentuin.)

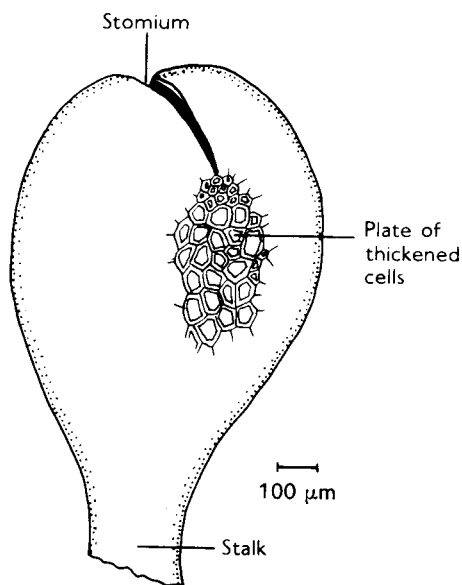

Figure 7.26 *Osmunda regalis*, sporangium.

Polypodiales, there are two features which distinguish them consistently from the remainder of the living ferns. These are, first, the origin of the sporangium, and, second, the plane of the first dividing wall of the zygote. In the Polypodiales the sporangium develops from a single initial cell, a condition termed *leptosporangiate*, contrasting with the eusporangiate condition of the Marattiales, Ophioglossales and Psilotales. Also in the Polypodiales, at least in those species which possess the typical heart-shaped gametophyte, the first dividing wall of the zygote is vertical or slightly oblique, parallel to the longitudinal axis of the archegonium, whereas in the eusporangiate ferns the first wall is perpendicular to the archegonial axis. The subsequent embryogeny of the Polypodiales is regularly endoscopic.

GROWTH FORMS AND ECONOMIC USES

In the constantly humid and warm temperate conditions of tropical mountains and rain forest the Polypodiales adopt a wide range of growth forms. Besides terrestrial species, both upright and rhizomatous, are found arborescent and scandent species, and numerous epiphytes. A remarkable creeping tree fern (*Cyathea planadae*), recently discovered in mid-elevation cloud forests in Colombia, has a decumbent stem giving rise to upright shoots. Amongst the epiphytes, a curious myrmecophilous form is *Lecanopteris* from Southeast Asia. The inflated and chambered rhizome houses colonies of ants. The sporangia, the walls of which contain fat, are sought by the ants and the spores thereby distributed. Myrmecophilous adaptations of this kind are otherwise found only in flowering plants. In many tree ferns the dead fronds remain attached and hang as a loose "skirt" around the trunk, making it difficult for climbing plants to ascend and smother the crown, a feature also of many palms.

The metabolism of the Polypodiales resembles that of the land plants generally. A number, mostly epiphytes, have been found to display CAM (crassulacean acid metabolism), in which respiratory carbon dioxide produced in the dark is incorporated into oxaloacetic acid, yielding malic acid. The carbon dioxide is released subsequently in the light and assimilated in the normal way, a metabolic pathway resembling that of C4 photosynthe-

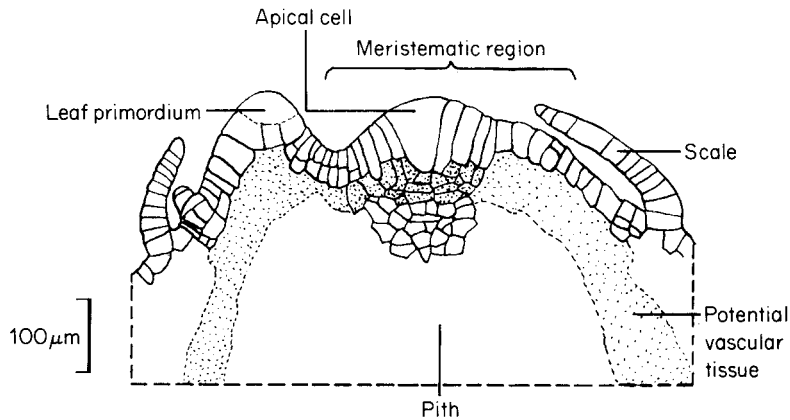

Figure 7.27 *Dryopteris aristata*.
Longitudinal section of stem apex.
(After Wardlaw, 1944. *Annals of Botany (New Series)* 8.)

GROWTH OF THE STEM

The stems of the Polypodiales grow from a single, conspicuous, apical cell (Fig. 7.27), tetrahedral in shape. Studies of cell lineages indicate that daughter cells are cut off in sequence from its three posterior faces. Nevertheless, fol-

sis (p. 6). Some terrestrial species are resistant to toxic metals. *Athyrium yokoscense*, a Japanese species, for example, is copper-tolerant. This depends upon the plant's ability to take the copper entering the plant into a thiolate complex, and thus remove it from the general metabolism.

Few Polypodiales figure in today's economy although some, for example *Pteridium*, have been valued in the past as a source of fuel, thatch and food. Young croziers of *Pteridium* are still cooked and eaten in parts of Southeast Asia, despite the presence of a carcinogen. In North America *Matteuccia* is similarly used as a delicacy ("fiddle heads"). Secondary plant products are a notable feature of some fern fronds and rhizomes (such as those of Central American species of *Phlebodium*), and yield extracts with minor medicinal uses. In some ferns these products are toxic. In *Pteridium*, for example, they include the insect-moulting hormone ecdysone, possibly providing protection from predators.

In the less stable regions of the Andes local Indians use the trunks of tree ferns for the framework of buildings. The resistance of the sclerenchyma to shattering by earthquakes is superior to that of timber. Several species of herbaceous ferns are popular horticultural plants, particularly those mutants with striking modification of the form of the frond. In Britain, avid collecting of ferns for horticultural use has led to the rarity of many native species. In Central America *Rumohra adiantiformis* ("leatherleaf") is extensively cultivated and exported for use by florists.

lowing autoradiographic studies, it has been disputed whether the apical cell itself divides. It seems that the nucleus of the apical cell may become polyploid. The cell then ceases to divide, but meristematic activity is retained by the cells adjacent to the posterior faces. Examination in polarized light has shown that the cellulose microfibrils in the tangential walls of these cells lie in arrays transverse to the axis of the stem. Consequently tangential growth is constrained, and expansion is predominantly radial and longitudinal.

The apex of the polypodialean ferns is evidently much less specialized than that of a flowering plant. A slice taken from the tip of the apex, no more than 0.25 mm (0.01 in.) in depth, will generate a normal stem in culture. The same result with flowering plants can be obtained only with a substantially greater explant.

The meristematic activity in the apical cone diminishes toward its base. Below the apical cone, cell divisions are more generalized and variously directed. Leaf primordia arise in this region in a definite phyllotactic sequence. A leaf primordium, first visible as a slight protuberance, soon develops its own apical cell. As the leaf primordia age and become separated by the expansion of the apex, bud primordia may be formed between them, but in some species buds do not appear at all so long as the apex is actively meristematic. Development of buds beyond the stage of primordia is rarely seen in the region of developing leaves. In a few ferns (e.g., *Nephrolepis*, common in cultivation) some of the buds grow out as runners (stolons) and provide a means of asexual

reproduction. Runners are also a feature of *Matteuccia struthiopteris* (ostrich fern).

A curious situation is found in *Pteridium* (bracken). The rhizomes of the mature plant are arranged in layers, the lowermost (up to 30 cm (12 in.) or more beneath the surface) consisting solely of "long" shoots with extended internodes. Most of the fronds are borne on short stubby rhizomes which ascend to near the soil surface. In the event of a "front" of bracken invading a new area, the lowermost rhizomes head the advance.

Since the apices of many ferns are comparatively broad and accessible, they provide excellent material for experimental work on phyllotaxy. The results indicate that the young leaf primordia, each a center of meristematic activity, suppress growth in their immediate vicinity. Thus, if the position in which a leaf primordium is expected to arise is isolated by radial incisions from the neighboring recently initiated primordia, then the new primordium develops with unusual vigor and outgrows the others. Similar experiments also confirm the fundamental similarity of stems and leaves in the Polypodiales. For example, tangential incisions on the anterior side of very young primordia that would normally yield leaves result in the production of stem buds instead. Incisions on the posterior side are without any effect. Consequently the determination of the subapical primordia appears to depend upon their being initially traversed by gradients of metabolites originating in the apical meristem. If a primordium is isolated from these gradients by an anterior incision it yields the radially symmetrical structure of a stem instead of the dorsiventral symmetry of a leaf. Naturally in interpreting the results of microsurgery, the growth-stimulating effects of wounding must also be taken into account.

FORMATION AND MORPHOLOGY OF THE STELE

The cells which yield the vascular tissue first become recognizable as a distinctively staining ring shortly below the apical cell. The diameter of the ring increases in register with that of the apex as a whole, and beneath the leaf primordia its cells become confluent with crescentic strands of similar cells descending from them. Further

down in the apex the cells of the ring are continuous with the procambium, and this in turn with the vascular tissue of the mature shoot. The position of the protoxylem is variable, but commonly mesarch. The large tracheids of the metaxylem have scalariform pitting, and in some instances (e.g., in the rhizome of *Pteridium*) the oblique end walls have scalariform perforations. These vessel-like channels, found also in the Marattiales (p. 177), may occur more frequently in the xylem of ferns than commonly supposed, and recall the situation in some species of *Selaginella* (see p. 155). The phloem consists of sieve cells with sieve areas confined to the oblique end walls. The vascular tissue is usually surrounded by a narrow zone of parenchyma, and then by an endodermis with a clear Casparian strip (see p. 185). The walls of the cortical cells adjacent to the endodermis are often thickened and made conspicuous by impregnation with phlobaphene. The endodermis and these thickened tangential walls probably together limit apoplastic transport between stele and cortex.

The form of the stele in the Polypodiales shows considerable variation (Fig. 7.28). In some species of *Gleichenia*, for example, the procambial tissue yields a solid core of tracheids from which the leaf traces depart without any break in the continuity of the xylem (*protostele*, Fig. 7.28a). Some other species of *Gleichenia* show a similar stele, but with the medullation of the tracheidal core leading to the production of a *siphonostele* (Fig. 7.28b).

In some ferns, in which the stele is cylindrical, phloem and endodermis are present both inside and outside the xylem (Fig. 7.28c). This form of stele, found principally in rhizomatous ferns, is termed a *solenostele* (or amphiphloic siphonostele). Leaf gaps are regularly present and sometimes additional perforations unrelated to the departure of leaf traces. The internal and external phloem and endodermis are in continuity around the margins of the gaps in the xylem. If the leaf gap and other perforations are close together, as in *Dryopteris*, the stele in section appears as a ring of anastomosing vascular bundles (Fig. 7.28d), each with internal xylem and concentric phloem. This type of stele, which is of widespread occurrence, is termed a *dictyostele*. A complication, shown for example by the rhizome of *Pteridium*

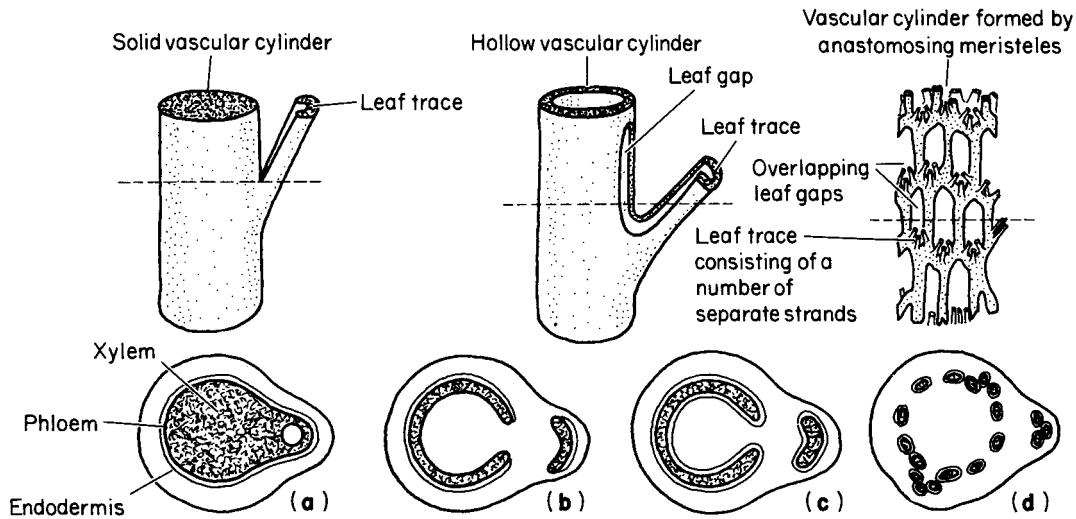

Figure 7.28 Principal forms of fern steles. (a) Protostele. (b) Siphonostele. (c) Solenostele. (d) Dictyostele.

(Fig. 7.29) and the trunks of the tree fern *Cyathea*, is the presence of two or more concentric vascular systems, interconnected at intervals and usually all contributing to the leaf traces. These steles are said to be *polycyclic*. Steles are not always radially symmetrical. Dictyosteles in the ferns with creeping rhizomes, for example, are often markedly dorsiventral, the departure of the leaf traces being confined to the upper surface and flanks (Fig. 7.30).

EXPERIMENTAL INVESTIGATION OF STELAR MORPHOLOGY

The form of the stele in the Polypodiales has also been the subject of experimental investigation. In *Dryopteris*, for example, if the apical region is isolated by vertical cuts, but left in contact below, it continues to grow and a solenostele differentiates behind it. As the apex expands and builds up a new crown, the stele gradually opens out to reform a dictyostele. In any one species, therefore, the size of the apex determines the form of the stele. This is also well shown in sporelings where a protostele is always present at the beginning. In protostelic species this merely increases in diameter as the plant develops, but in solenostelic and dictyostelic species the protostele of the sporeling becomes medullated, and phloem and endodermis appear within in step with the increasing

girth of the apex. This relationship between size and form is clearly the consequence of physiological equilibria, but they are undoubtedly complex and have yet to be resolved.

OTHER ANATOMICAL FEATURES OF THE STEM

In addition to the xylem, which is wholly primary, there are frequently bands or rods of sclerenchyma in the stem contributing to its rigidity. In the tree ferns, for example, many of which reach or exceed heights of 10 m (33 ft), mechanical stability is dependent almost entirely upon the extremely tough girdle of sclerenchyma in the outer cortex, often in association with the leaf bases. In those Polypodiales which are believed, on the basis of fossil evidence, to be relicts of very ancient groups (e.g., *Gleichenia*), the parenchymatous tissue of the stem often contains resin sacs and mucilage canals. Amongst the Polypodiales more recent in origin these features are less evident.

ROOTS

After the primary root all subsequent roots are adventitious, in arborescent forms often being produced even in the aerial regions and providing a mantle of stubby outgrowths between the leaf bases. Roots show a distinct apical cell, but in some instances this may be quiescent, divisions being confined to the cells at its flanks. As in other ferns a root cap is present, and in many species

Figure 7.29 *Pteridium aquilinum*.
Transverse section of rhizome.

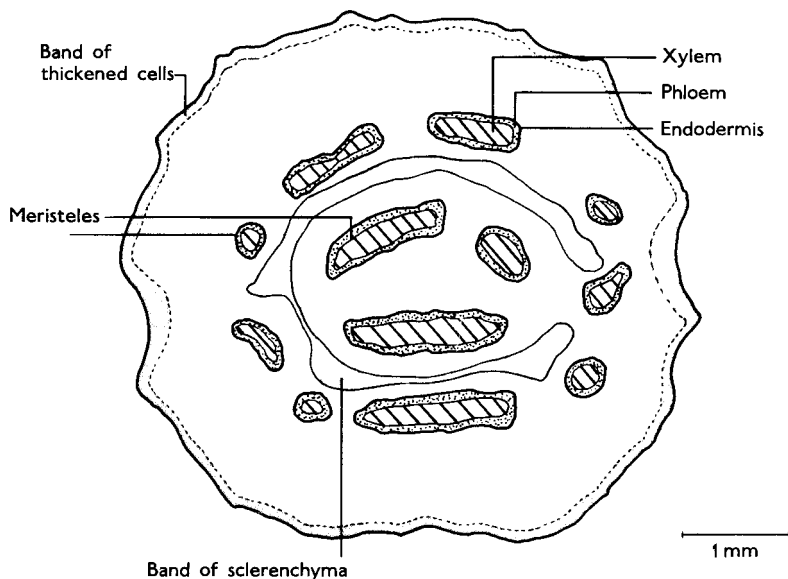

root hairs. The xylem is commonly diarch, and in many epiphytic forms all but the protoxylem often remains unligified. The roots of some ferns produce shoot buds. These facilitate the rapid colonization of a new area.

MORPHOLOGY AND ANATOMY OF THE VEGETATIVE LEAVES

The leaves of the Polypodiales retain an apical cell during their development from the primordium. Some form of pinnate branching is usually present in the mature leaves. True dichotomous branching occurs very rarely (the frond of *Rhipidopteris peltata* provides one of the few examples), but cymose branching, superficially resembling dichotomy, is shown by the leaves of several species of *Gleichenia*. The filmy fern *Cardiomanes reniforme* of New Zealand has a striking, entire, kidney-shaped leaf, up to 5 cm (2 in.) in width. Notable also is the filmy epiphyte *Microgonium tahitense* of the Asian tropics. The habit resembles that of the common angiosperm epiphyte *Dischidia*. The filiform rhizome, growing on smooth-barked trees, bears peltate leaves which are almost sessile and appressed to the substrate. Roots are absent, but the rhizome and the margins of the leaves bear rhizoids.

In a few Polypodiales meristematic areas are retained in the differentiated leaf, and these subsequently grow out to form either additional leaves (as in *Trichomanes proliferum* (Fig. 7.31)) or new plantlets (as in *Asplenium mannii* and *Camptosorus radicans*). These forms illustrate how in the living ferns, as in the extinct (see p. 172), the leaves sometimes display features suggestive of stems. All parts of the young leaves usually show circinate vernation. The extension of the rachis and the unrolling of the pinnae clearly involve considerable coordination of growth in space and time. There is evidence that this is dependent

upon the diffusion, and varying relative concentrations, of auxins (growth-regulating substances) in the expanding leaf, but these auxins are not necessarily identical with those in seed plants. The expanding leaves of some ferns, for example of the tropical *Dryopteris decussata*, are enveloped in mucilage, possibly with some protective effect. Extrafloral nectaries are found at the points of branching of the frond of *Pteridium*. There is no evidence that they have any function apart from the secretion of surplus metabolites.

The lamina of the leaf is commonly differentiated into palisade and mesophyll, but the texture is very variable and in some species a thick cuticle on the upper surface gives the leaf a surprising harshness. "Filminess" is a consequence of the lamina being only one cell thick. This condition, already seen in *Leptopteris* (Osmundales, p. 188), is found throughout the family Hymenophyllaceae. Filmy ferns are necessarily confined to situations of continuously high humidity. They are often able to thrive in irradiances far below those tolerated by flowering plants, and more akin to those of the bryophyte communities with which the epiphytic forms are frequently mixed. In *Hymenophyllum malingii*, a peculiar epiphyte of New Zealand, the leaf lacks a lamina. Instead the axes of the pinnately branched frond bear green filaments interspersed with stellate trichomes. Some of the larger tropi-

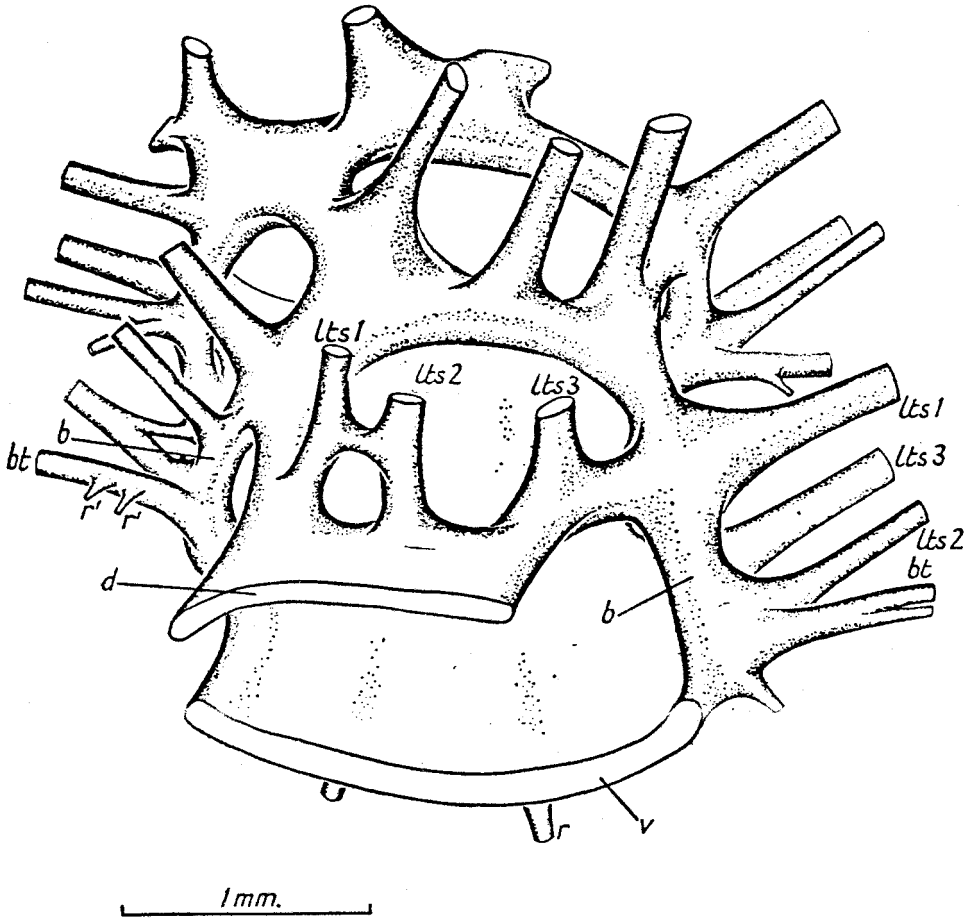

Figure 7.30 *Elaphoglossum latifolium*. Reconstruction of stele showing the dorsiventral symmetry: v, ventral meristele; d, dorsal meristele; b, bridge connecting the dorsal and ventral meristeles; bt, bud trace; lts, strand of the leaf trace; r, root trace; r', root in association with bud trace. (From Bell, 1950. *Annals of Botany (New Series)* 14.)

cal epiphytes are distinguished by producing sterile leaves of two forms. In addition to the erect photosynthetic leaves are others which clasp the support. The latter soon die, but persist in a rigid scarios condition and serve as collectors of humus and moisture. *Platyserium* (Fig. 7.32) provides a striking example of this kind of habit. In other epiphytes of similar situations the leaves, borne on a short upright rootstock, are stiff and tightly overlapping, so forming a funnel which traps rain and organic matter. *Asplenium nidus* provides a typical example of these "nest ferns". The

material at the base of the funnel is freely penetrated by absorptive rootlets.

The leaves of many temperate ferns die during the winter, but remain attached (and are said to be *marcescent*). In some species (e.g., *Polystichum lonchitis*) the leaves remain green, even in harsh conditions. Experiments have shown that these leaves provide a net contribution to assimilation, particularly early in the following season's growth.

THE FERTILE LEAVES AND THE NATURE OF THE SPORANGIA

The fertile leaves of the Polypodiales are often quite similar to the sterile (as in *Dryopteris*), but dimorphy is not uncommon. In *Blechnum spicant*, for example, both sterile and fertile fronds are simply pinnate, but in the fertile ones the sterile part of the lamina is very reduced. The sporangia arise from single initial cells and are therefore *leptosporangiate*, either at the margin or on the lower

Figure 7.31 *Trichomanes proliferum*. Frond, showing indefinite growth. (From Bell, 1960. *New Phytologist* 59.)

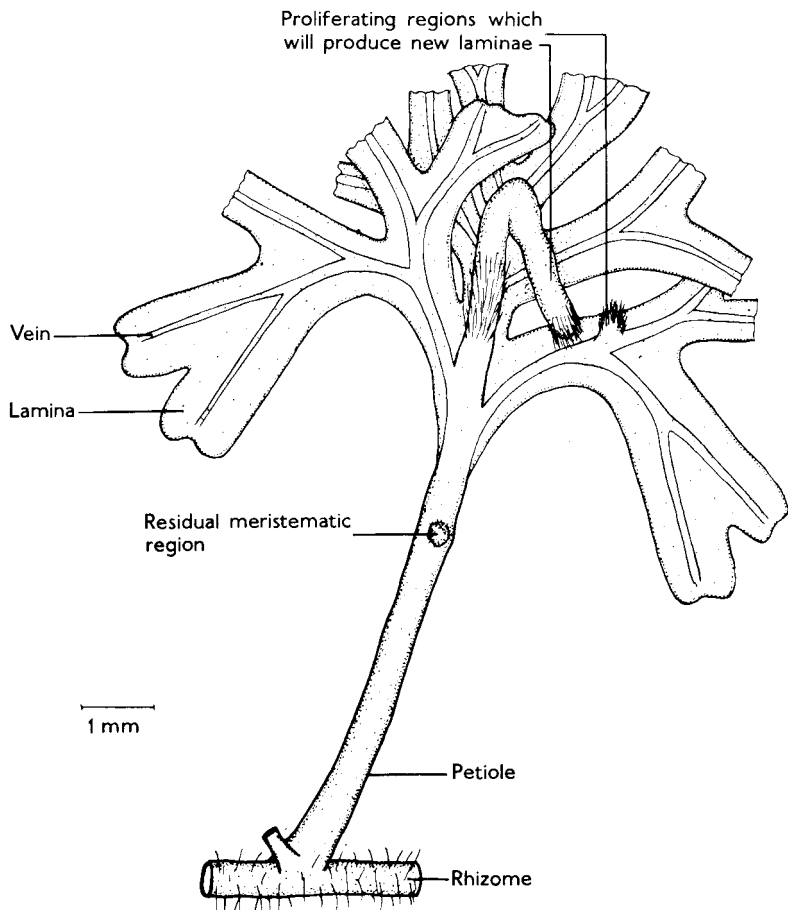
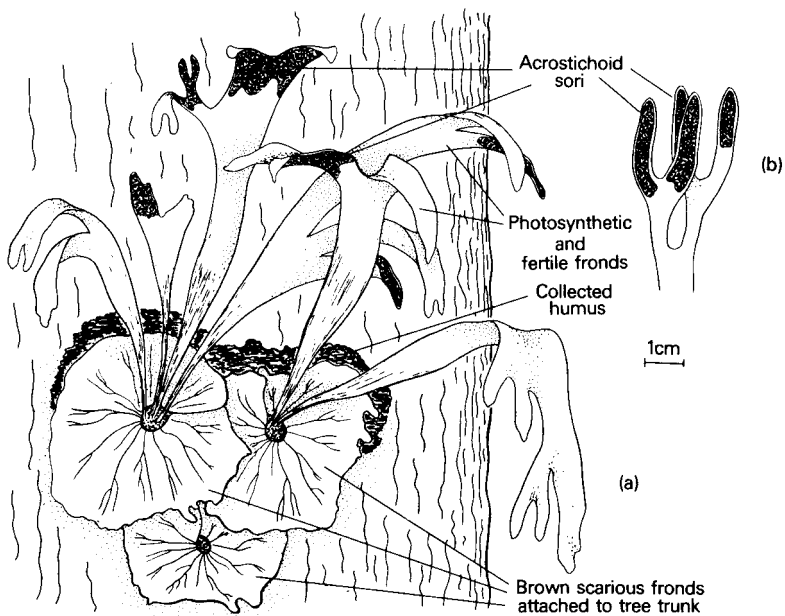

Figure 7.32 *Platycerium*. (a) Habit, showing the two forms of leaves. (b) Lower surface of fertile portion of frond.



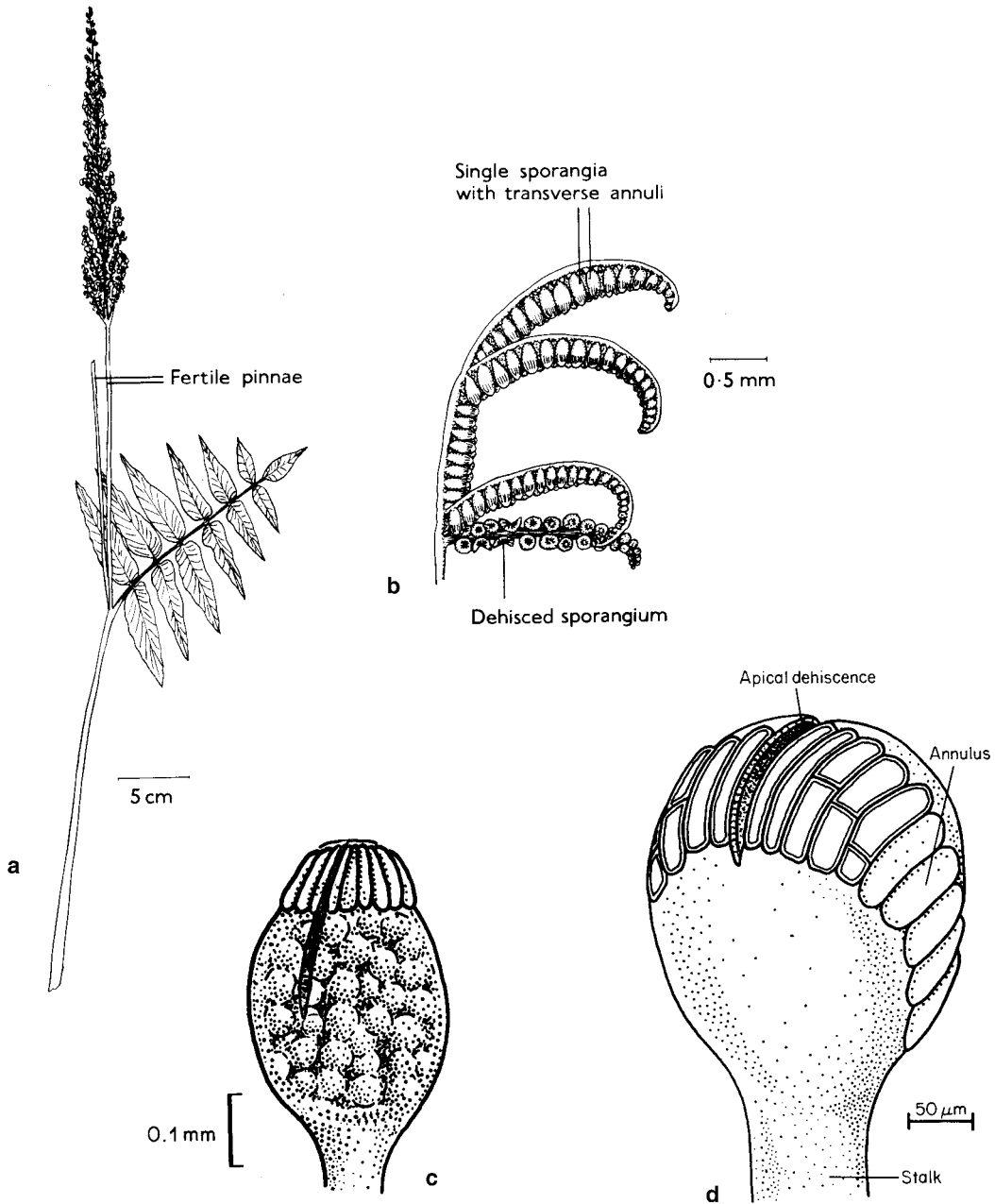

Figure 7.33 (a–c) *Anemia phylliditis*: (a) fertile frond; (b) portion of fertile region; (c) sporangium showing transverse annulus. (d) *Gleichenia*, sporangium.

surface of the leaf. The mature sporangium has a distinct stalk, the structure of which ranges from a broad multicellular stump to a delicate and relatively long column of cells. The wall of the capsule is only one cell thick, and it always con-

tains a group of indurated cells and a well-defined stomium. The indurated cells are arranged in a single band (annulus) which encircles the sporangium, transversely near the apex of the sporangium (as in *Anemia* (Fig. 7.33c) and other Schizaeaceae), or obliquely (as in *Gleichenia* (Fig. 7.33d) and the Hymenophyllaceae), or vertically (as in *Dryopteris* (Fig. 7.34) and most common temperate ferns). The annulus is interrupted by the

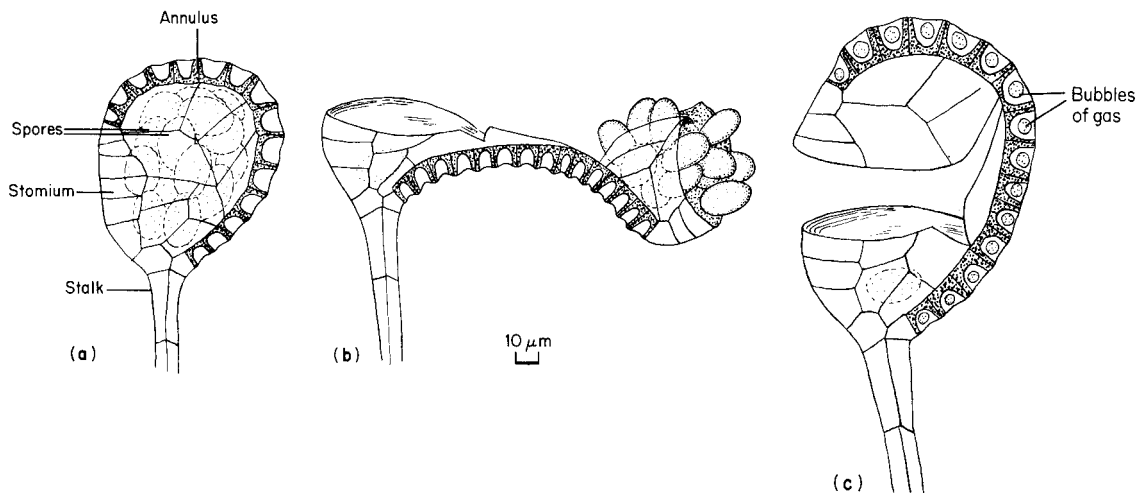

Figure 7.34 *Dryopteris*. Stages in dehiscence of sporangium. (After Ingold. 1939. *Spore Discharge in Land Plants*. Oxford University Press, Oxford.)

stomium. Where the annulus is vertical, it is also interrupted by the stalk of the sporangium, the stomium then lying just in front of the stalk. The sporangium dehisces at the stomium as a consequence of tensions set up in drying. The mechanism has been studied in detail in those ferns where the annulus is vertical. Here, as the cell sap in the annular cells diminishes by evaporation, asymmetrical thickening of the cell walls (Fig. 7.34) causes an increasing tangential tension which tends to reverse the curvature of the annulus. The stomium eventually breaks, and the upper part of the sporangium gradually turns back as if on a hinge (Fig. 7.34). Tension in the cells of the annulus soon reaches a critical level; at this point the water remaining in the annular cells spontaneously becomes vapor. The tension is immediately released, and the upper part of the sporangium flies back to more or less its original position (Fig. 7.34). These two movements effectively disperse the spores. It has sometimes been observed that the movements are repeated, a feature not so readily explained.

ARRANGEMENT OF THE SPORANGIA

In most Polypodiales the sporangia arise in distinct sori, usually beneath veins or near their extremities, these two positions being called *superficial* and *marginal* respectively. Sometimes the

sporangia are produced in a continuous line, referred to as a *coenosorus*, well shown, for example, by *Pteridium*. The sorus is often partly or wholly covered by an outgrowth of the lamina, called an *indusium*, which adopts a characteristic form. In *Dryopteris*, for example, the indusium is reniform (Figs. 7.35 and 7.36), and in *Polystichum* peltate. In *Onoclea* the sori are protected by a rolling up of the fertile pinnules. In some species of *Polypodium*, where an indusium is typically absent, the sori are immersed in the lower surface of the lamina. A few ferns show the so-called “acrostichoid” condition in which the sporangia arise as a continuous felt on the lower surface of the fertile frond (e.g., *Platynerium*, Fig. 7.32). In some ferns (e.g., *Gleichenia*) the sporangia in a sorus are all of the same age (Fig. 7.37a,b), in others they are produced in spatial and temporal sequence on an elongated receptacle (as in the Hymenophyllaceae) (Fig. 7.37c,d), yielding a so-called “gradate” sorus, and in yet others the sporangia are produced over a period but intermingled, leading to a so-called “mixed” sorus (Fig. 7.37e,f) (as in *Dryopteris* and most common temperate Polypodiales).

DEVELOPMENT OF THE SPORANGIA AND SPORES

In the development of the sporangium a cluster of spore mother cells becomes surrounded by a two-layered tapetum. In origin this is part of the wall tissue and not of the archesporium, as in eusporangiate sporangia. The cytological changes accompanying meiosis provide a model for spor-

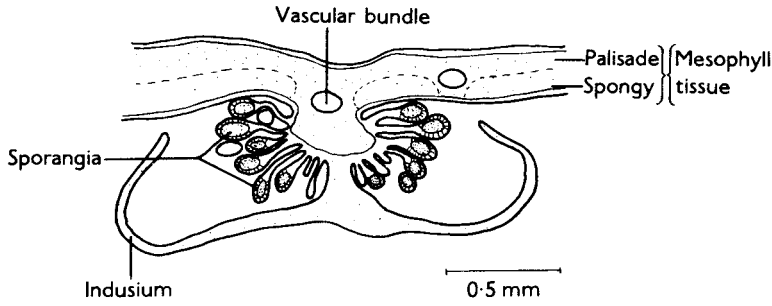

Figure 7.35 *Dryopteris filix-mas*. Vertical section of sorus.

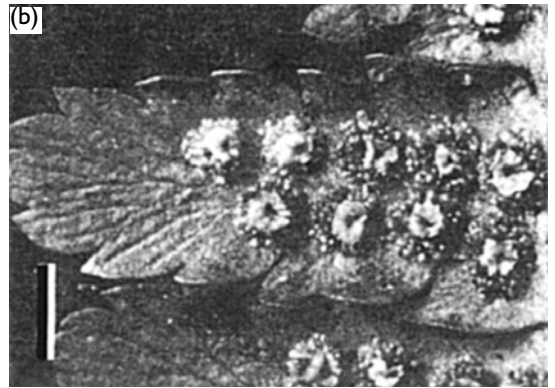
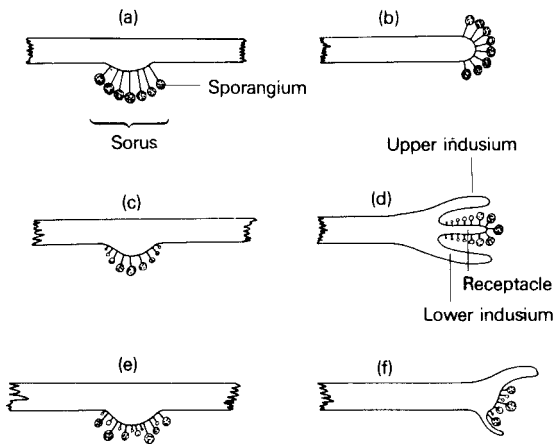

Figure 7.36 The abaxial surface of fertile pinnules of *Dryopteris filix-mas*. (a) The sori in a young condition, before dehiscence of the sporangia. (b) Three weeks later, most of the sporangia having dehisced. Scale bars 2 mm.

ogenesis in the land plants generally. As their nuclei enter prophase the spore mother cells become surrounded by a thickened wall, and cytoplasmic connections between them are extinguished. The presence of callose in this special wall has not yet been convincingly demonstrated. During prophase the density of the cytoplasm diminishes and there is a loss in affinity for basic stains, largely accounted for by a fall in the frequency of ribosomes and hence in the concentration of RNA. Spores are produced in tetrads. The first exine is secreted by the spore itself. At this stage the thickened wall of the mother cell, weakened by autolytic degradation, breaks open. The spores then separate and complete their development in the breakdown products of the tapetum.



Some 2^6 to 2^8 spores are produced in each sporangium, the higher numbers being characteristic of the families believed to be more primitive. The spores are usually of the order of $40 \mu\text{m}$ in diameter, but measurements of a representative sample will usually show a normal distribution with a range of about $\pm 10 \mu\text{m}$ about the mean. A few ferns, normally included with the

Figure 7.37 Principal forms of sorus. (a,b) Simple, the sporangia all of the same age: (a) superficial; (b) marginal. (c,d) Gradate: (c) superficial; (d) marginal. (e,f) Mixed: (e) superficial; (f) marginal.



Figure 7.38 *Platyzoma microphyllum*. View of the fronds, showing the two rows of subopposite cup-like pinnules. Fertile regions occur at intervals along the frond, the sporangia obscured by the recurved margins of the pinnules. The juvenile fronds consist solely of a slender green rachis, lacking pinnules. Scale bar 1 cm. (Photograph provided by Pamela Warren Wilson.)

homosporous, do in fact produce spores of different sizes. The most extreme example is seen in *Platyzoma*, a fern of very unusual appearance (Fig. 7.38) growing on deep sands in northeast Australia. Although the mature sporangia are all about the same size, some produce 16 large spores and others 32 smaller ones (although the diameter of these is greater than that of fern spores in general). A histogram shows a clearly bimodal distribution. Nevertheless, a random sample of spores reveals a preponderance of small spores and a wide range of spore sizes within each size class (Fig. 7.39). The difference in spore size seems to result from the greater availability of nutrients and space for spore growth when the number is

lower. The size of the spores is related to sex expression (p. 204).

The outer part of the spore wall (exine), the material of which is derived from the tapetum, is sometimes deposited in a characteristic pattern of bars and ridges. This is especially true of the Schizaeaceae, and it provides a feature that has been very useful in identifying fossil forms. In some ferns, principally the more recent, the spores are monolete instead of trilete. Monolete spores (p. 160) often have an additional translucent investment, called a *perispore*, formed from the remains of the tapetum. In a few ferns monolete and trilete spores are found in the same sporangium.

Production of viable spores usually fails in hybrid ferns. Meiosis is irregular, the pairing of the chromosomes being only partial or even wholly absent. Division spindles are largely distorted, and, although there is an attempt at sporogenesis, most of the spores are usually inviable. They are also often irregularly fused together by

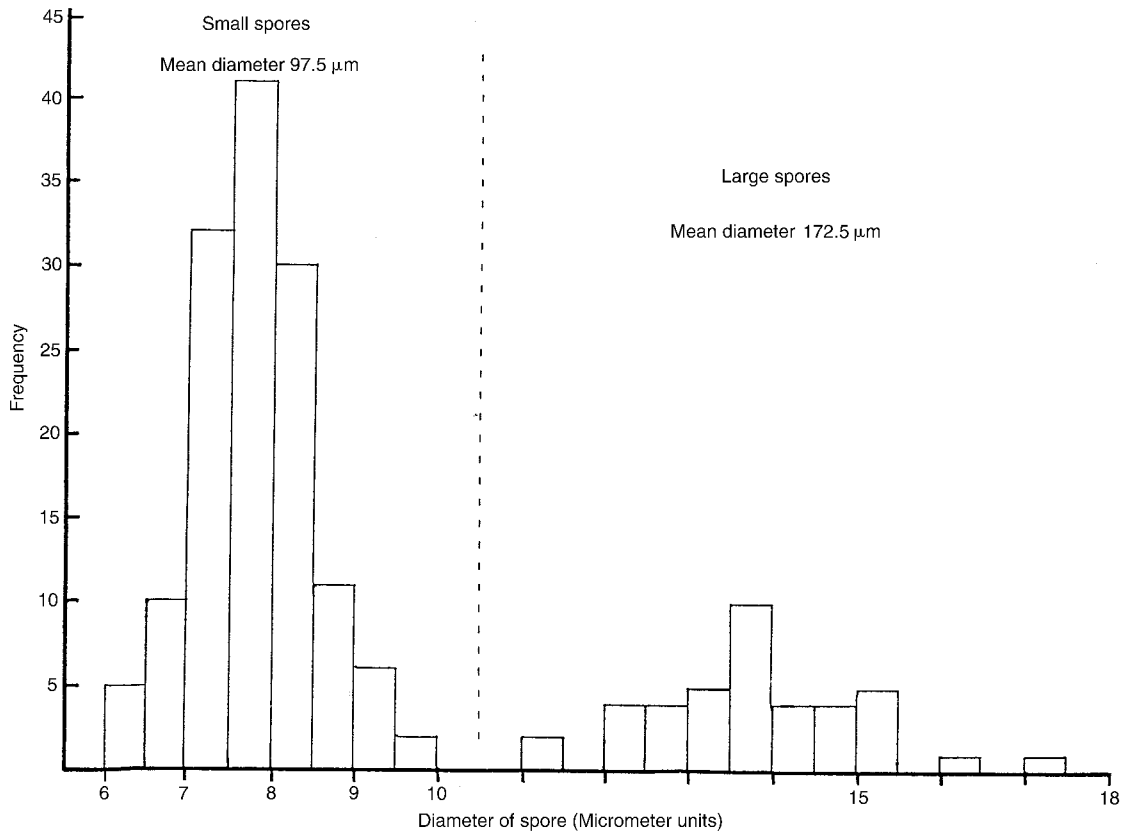

Figure 7.39 The size distribution of 177 spores of *Platyzoma microphyllum* collected in Queensland, Australia. The sample was taken from the fertile regions of three fronds from different plants. The spores were mounted in 25 percent alcohol. Ten non-overlapping fields, selected at random, were photographed and the negatives printed at a total $\times 80$ final magnification. The maximum diameters of the spores were measured with a magnifying micrometer, the scale graduated in 0.5 mm intervals (1 mm representing 12.5 μm). (S. Laird, unpublished.)

exine into dyads or triads. Similar spore formations are well known in ancient deposits. This has given rise to the suggestion that hybridization was also a feature of early land plants. However, the genetic control of meiosis is complex and must itself have been subject to evolutionary refinement. Irregular spore formations in the Paleozoic era may have been a consequence of meiosis itself at that time not having achieved the regular perfection that is commonly seen today.

THE GAMETOPHYTIC PHASE

In some families, as in the Osmundales, the spores are green when shed, but normally chlorophyll is absent. Non-green spores are often rich in lipid, amounting in some instances to 60 percent of the dry weight. Green spores are short-lived, but non-green spores may remain viable for many years, particularly if buried in soil. In this way "banks" of viable spores may be formed beneath stands of ferns, germination occurring only if the spores are brought to the surface. Such reservoirs of spores provide for the re-colonization of areas cleared by cultivation or other disturbance.

Although moisture is essential for germination, the requirement for light is variable. Some spores (e.g., *Pteridium*) germinate in the dark, but others require the stimulus of red light. The phytochrome system is evidently involved, but the situation is not simple since in some instances the effect of red is reversed by both far-red and blue. After the first division the protruding daughter cell often yields a colorless rhizoid, the elongation

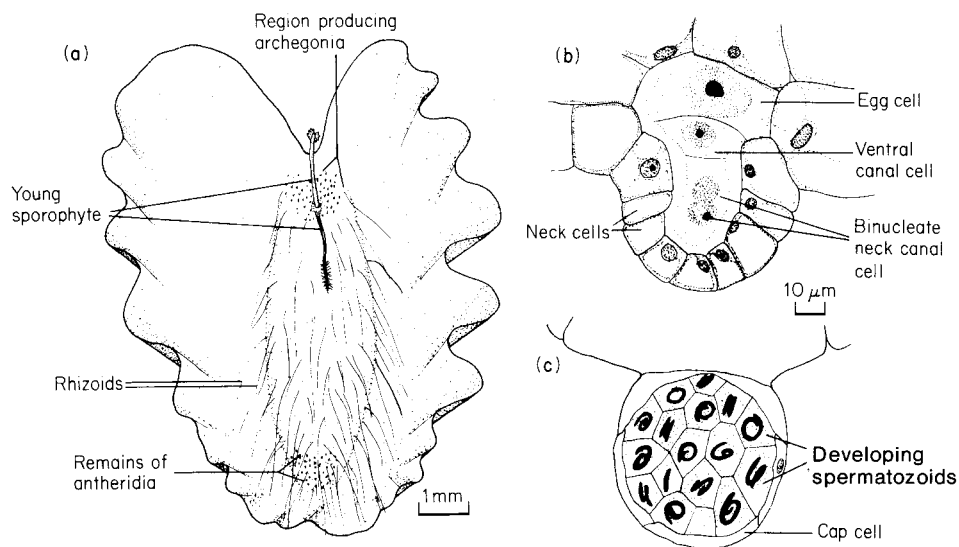

Figure 7.40 (a) *Pteris ensiformis*. Lower surface of gametophyte, bearing young sporophyte. (b,c) *Pteridium aquilinum*: (b) median longitudinal section of young archegonium; (c) almost mature antheridium.

of which may be promoted by metal ions present in the perispore. Continued divisions give rise to an algal-like filament, the growth of which is predominantly apical, furnished with a few rhizoids. Germination and production of the first rhizoid appear to be resistant to inhibitors of transcription, so it is probable that these initial steps are dependent upon long-lived messenger RNA already present in the spore.

In some Polypodiales (the Hymenophyllaceae, for example, and some Schizaeaceae), the gametophyte remains filamentous and the sex organs are borne on lateral cushions of cells. Yet other gametophytes are ribbon-like, and the ribbon may branch freely. In many ferns (of which *Dryopteris* and *Pteridium* provide familiar examples) the cell at the apex of the initial filament soon begins to divide in a number of directions, leading to the formation of a cordate (heart-shaped) gametophyte (Fig. 7.40). There is no general agreement about the cause of this change from one-dimensional (1D) to two-dimensional (2D) growth, but it seems likely that it is a consequence of a changing balance between carbohydrate and protein metabolism. When the protein metabolism is depressed in relation to the carbohydrate (as can be caused experimentally by growing the cultures in red

light) the gametophytes persist indefinitely as filaments with elongated cells. In blue light, which changes the balance of the metabolism in favor of protein, the cells divide more frequently and become progressively shorter, their width remaining little changed. Ultimately the apical cell becomes broader than long. In these conditions 1D growth gives way almost immediately to 2D. The change in the direction of division at the apex of the filament is in accordance with the concept that the plane of the new wall in a dividing cell is transverse to the principal stress in the plasmalemma (which in turn may influence the alignment of microtubules). In cells which are longer than broad this stress, caused by the turgor of the cells, is longitudinal, and hence the new wall transverse. In cells broader than long the principal stress is transverse to the filament, and the new wall correspondingly longitudinal or almost so. Substances which affect the rate of growth, and the rapidity with which growth changes from 1D to 2D, can be isolated from media in which spores have been cultured. The proportions of these substances vary in relation to the wavelength of the light to which the cultures have been exposed. Nevertheless, there is no evidence as yet that the transition from 1D to 2D growth is dependent upon the activation of specific genes. Since the transition can also occur in high irradiances of continuous red light, it seems much more likely that it is a consequence of correlations

between the carbon/nitrogen balance of the metabolism of the gametophyte and the proportions and stresses in the walls of the dividing cells.

Once established, the apical cell evidently retains close symplastic connections with the growing area of the gametophyte. Investigations of the developing cordate gametophytes of the fern *Onoclea sensibilis* have shown that the basipetal walls of the apical cell are well furnished with plasmodesmata. Frequencies of some 14 plasmodesmata μm^{-2} were regularly found, values comparable with those occurring in the walls of glandular cells with high rates of plasmodesmatal transport.

Mycorrhizal associations are probably common in fern gametophytes. The gametophytes of some tropical Schizaeaceae, for example, are subterranean (resembling those of *Psilotum* (p. 187)) and are thus presumably wholly dependent upon endophytic fungi for their nutrition. In *Schizaea pusilla*, a species with a phototrophic filamentous gametophyte, the presence of a truly mycorrhizal fungus in wild populations was conclusively demonstrated by isolation of the fungus, and the finding that continued development of aseptically germinated spores was dependent upon inoculation.

Despite their delicate structure, the gametophytes of some ferns have proved surprisingly resistant to desiccation and freezing, their tolerances often far exceeding those of the sporophytes. A few gametophytes have modifications which clearly promote survival. That of the Mediterranean *Anogramma leptophylla*, for example, has a tuberous portion resistant to drought, resulting in the curious situation of the sporophyte being annual and the gametophyte perennial. The subterranean gametophytes of a few tropical species of the Schizaeaceae may also have survival value.

SEX EXPRESSION IN THE GAMETOPHYTE

In those filamentous gametophytes which bear their sex organs in clusters on lateral cushions, the male and female cushions are commonly separated. Cordate gametophytes, at least when young, bear their sex organs in the apical region, sexual expression almost always beginning with a male phase. Following the male phase, archegonia

begin to be produced acropetally in more or less orderly files behind the apical meristem. The gametophytes of some ferns go through several cycles of male/female sex expression in normal development, but in *Pteridium* aging female gametophytes lose an organized apical meristem, the production of archegonia gradually ceases, and growth in turn becomes disordered and irregular. Lateral proliferations of the gametophyte may then begin to produce antheridia. For a short time intragametophytic selfing is thus possible, but in *Pteridium* such selfing often results in defective sporelings. This may be a consequence either of the homozygosity of deleterious genes or of the egg cells produced at the time of the re-establishment of a male phase being themselves defective. Nevertheless, in *Lygodium* antheridia and archegonia appear to be regularly produced intermixed, a condition recalling that in synoicous mosses (p. 123).

A sample of fern spores sown on an agar plate will frequently yield, after a period of culture, a scattering of small cordate gametophytes in which a clear apical meristem is becoming evident, and just behind it the production of archegonia. Other spores will have yielded clusters of cells lacking apical organization, and commonly covered with antheridia. These gametophytes remain *ameristic* and male indefinitely. Some ameristic gametophytes are always present, but the proportion tends to rise with increasing density of sowing.

Experiments have shown that the control of sexuality in a culture of fern spores is remarkably complex. When gametophytes are grown in pure culture substances accumulate in the medium which stimulate the production of antheridia in other young gametophytes. The chemical nature of these substances, called *antheridiogens*, varies with species, but some are closely similar to gibberellins. Currently 12 compounds have been isolated and found to have antheridiogen activity. As a gametophyte passes from the antheridial to the archegoniate phase it becomes insensitive to its antheridiogen, but it is still secreted into the medium. A genetic control of the effects produced by antheridiogens has been demonstrated in the fern *Ceratopteris*. Here, the only stage which responds to the fern's antheridiogen begins just after germination and lasts only until the

gametophyte has reached 4–5 cells in size. In the presence of the antheridiogen such a gametophyte will remain ameristic and male. Several mutations, however, have been found to affect this response. One mutation (*her*) suppresses the response and the gametophyte behaves as a hermaphrodite. Another mutant (*fem*) interferes with the production of antheridia and gametophytes grow into meristic females in the presence or absence of the pheromone. Interestingly the effect of the antheridiogen on young gametophytes can be suppressed by adding abscisic acid (a known antagonist of gibberellin in flowering plants) to the medium. The gametophytes in these conditions grow directly into hermaphrodites. The mixed phenotype of a culture on an agar medium evidently depends upon spore-to-spore differences in the times of germination and the rates of early development, combined with the interaction of at least three genes controlling competence and response. Some alleles of the *her* mutation, when homozygous in the sporophyte, interfere with the development of the fertile frond. Adventitious buds may then be present amongst the sporangia.

Although studied mostly in axenic conditions, there is now evidence that antheridiogens regulate sexuality in natural populations of gametophytes. The results of some field experiments have indicated that the influence of antheridiogens on the formation of apical meristems in developing gametophytes and the induction of maleness are separate effects. This would imply that antheridiogens have the properties of both a hormone and a pheromone.

A particularly interesting situation is found in *Platyzoma* (p. 200). Here the small spores give rise to gametophytes which remain depauperate and male, while the larger spores yield complex gametophytes which are female, but may subsequently also bear antheridia. Spore size will inevitably be related to the amount of cytoplasm forming the initial endowment of the spore, and it may be this feature which governs subsequent growth and sex expression. Explants of the diminutive male gametophytes, if transferred to mineral-agar medium, have been observed to regenerate and give rise to hermaphroditic growths, indicating that development is able to

escape from its initial constraints. It has not, however, been demonstrated that this escape is possible with gametophytes from the smallest spores, and a full understanding of the factors determining sex expression in the gametophytes of *Platyzoma* awaits further research.

It is conceivable that the ameristic gametophytes arising in cultures of ferns whose spores are more uniform in size are also the product of spores which have received by chance a reduced amount of cytoplasm during the final divisions of sporogenesis. Their relatively retarded development would leave them open to the full effects of the antheridiogen coming from their more advanced neighbors.

DIFFERENTIATION OF THE GAMETES

Antheridia usually contain 2^5 or 2^6 spermatocytes, often with callosed walls. Each differentiates a spermatozoid. There is active protein synthesis during the initial stages of spermatogenesis, but the later stages (including the formation of the flagella) appear to be largely a matter of protein assembly. When the antheridia are mature, flooding causes the mucilage within to swell. The cap cells are then forced off and the spermatocytes extruded. The flagella of the spermatozooids become active and each breaks free from its mucilaginous shell. The motile spermatozoid is about 5 μm long and takes the form of a helix with a left-handed (anticlockwise) screw (cf. Fig. 7.49). The anterior gyre is taken up with the multilayered structure and the associated mitochondrion, and the remaining gyres with the nucleus and microtubular ribbon. Plastids are absent from the differentiated gamete (Fig. 7.49). The flagella, confined to the anterior gyres, emerge tangentially and are directed posteriorly. They beat with a helical wave which drives the spermatozoid forward and at the same time causes it to rotate in the sense of the screw. Current observations on a range of species reveal that spermatozooids may remain active for up to two hours following release, but whether they similarly retain the ability to effect fertilization has not been established.

The necks of the archegonia, consisting of 4–6 tiers of cells, usually project conspicuously and are often recurved. As in the liverworts *Marchantia* (p. 107) and *Sphaerocarpos* (p. 114), the maturation

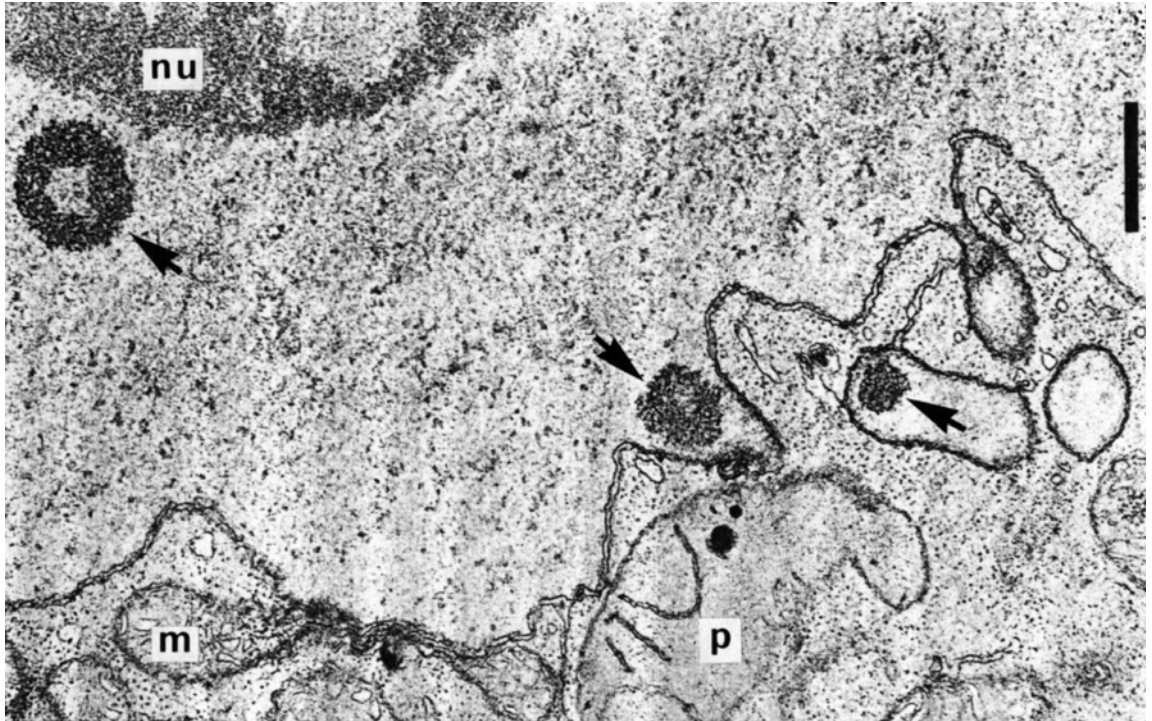

Figure 7.41 Part of a median section of a maturing egg of *Pteridium*, showing the margin of the nucleolus (nu), and nuclear bodies (arrows) in the nucleoplasm and in vesicles budded off from the nucleus. The chromatin is highly dispersed. m, mitochondrion; p, plastid. Scale bar 0.5 μm .

of the egg, completed within about 24 hours, involves in many species extensive interpenetration of nucleus and cytoplasm. Simultaneously, small aggregates of dense material (“nuclear bodies”), 300–500 nm in diameter, and apparently formed at the periphery of the nucleolus, spread throughout the nucleoplasm. These aggregates enter vesicles, bounded by both membranes of the nuclear envelope, which bud off from the surface of the nucleus and are soon present throughout the cytoplasm (Fig. 7.41). It has not been possible to detect nucleic acids, either in the nuclear bodies or in the material in the vesicles; it appears to be principally, if not entirely, acidic protein. These bodies are not therefore correctly called “micronucleoli”. The significance of this remarkable cytology is not yet known. Although it was first thought to be concerned with the establishment of sporophytic growth, it is clearly not essential for the generational change, since it is not

present in all ferns. It is not, for example, a feature of oogenesis in *Osmunda*. Nuclear-cytoplasmic behavior similar to that seen in the maturing egg cells of *Pteridium* and *Dryopteris* is seen in somatic cells of *Nicotiana* infected with tobacco mosaic virus. It is conceivable that some ferns, as do many wild herbaceous flowering plants, carry symptomless viruses, re-infection of the succeeding generation taking place during oogenesis.

The mature egg lies in a chamber with a thickened and often callosed wall. The egg protoplast is surrounded by a conspicuous membrane. Although acetolysis-resistant, it does not appear to contain sporopollenin, but to consist of polymerized lipids or fatty acids (and thus to resemble the acetolysis-resistant components of certain algal walls (pp. 45, 65)). The material for the membrane is secreted on to the surface of the egg by a process of exocytosis, being derived from a breakdown of a proportion of the cytoplasmic organelles during oogenesis. The egg cells of more recent ferns, such as *Pteridium* and *Dryopteris*, lack the conspicuous amyloplasts which are a feature of the egg cells of *Todea* and *Osmunda* (Osmundales), and *Angiopteris* (Marattiales), undoubtedly relicts of ancient lineages.



(a)

Figure 7.42 *Trichomanes speciosum*. (a) A sporophyte photographed at Flores in the Azores. (b) A stand of gametophytes (arrows) growing on and under a sandstone boulder at Bingley, Yorkshire. Although the species was originally described from this locality, the sporophyte now appears to be extinct here. (Photographs provided by Johannes Vogel, Natural History Museum, London.)

Flooding causes mucilage within the canal of the ripe archegonium to swell. The cap is forced off and the contents of the canal ejected. A clear passage, containing watery mucilage, now runs down to the surface of the egg cell.

Some fern gametophytes appear reluctant to produce sex organs in the wild, although they may do so more freely in laboratory conditions. Pale green ribbon-like thalli, resembling small liverworts and locally abundant in shaded rocky areas of parts of temperate North America, are believed to be gametophytes of *Vittaria*, but sporophytes are rare, and if present are commonly no more than stunted juveniles. The evolution of these forms may have followed from the gametophytes being more tolerant of cool conditions than the corresponding sporophytes. The filamentous gametophytes of some species of *Trichomanes* are also found with defective sexual reproduction

(b)



well beyond the present distribution of the sporophyte in both North America and Europe. Some wholly gametophytic stands of the European *T. speciosum* (Fig. 7.42), for example, occur more than 1000 km (c. 600 miles) from the nearest sporophytes, and may be 1000 or more years old. Antheridia are found in about half these colonies, but archegonia are very few. Reproduction of these imperfect forms must be largely by fragmentation and gemmae (Fig. 7.43). The distribution of the filmy fern *Mecodium wrightii* of British Columbia and Alaska has similar features, apparently sterile gametophytes being more widespread than sporophytes. *Callistopteris baueriana*, a filmy fern occurring throughout the Hawaiian archipelago, shows a less extreme situation. The gametophyte is a narrow branching thallus, which, at some sites, may form dense pure stands lacking sporophytes, although elsewhere sporophytes are conspicuous.

The gametophytes of some ferns with normal cycles also multiply asexually. With ferns in which the gametophyte has a prolonged filamentous phase before becoming thalloid (as in the family Grammitidaceae), fragmentation of the filaments often leads to a number of independent gametophytes, each capable of sexual reproduction. Specialized gemmae, borne at the tips of filaments (termed *sterigmata*) (Fig. 7.43), are a regular feature of many of the filamentous gametophytes of filmy ferns. Older gametophytes of the cordate kind of many ferns will proliferate at the margins and yield a crop of younger gametophytes which resume a sexual function. Others, such as those of the tropical Asian epiphyte *Lecanopteris*, produce marginal multicellular gemmae on short stalks. The tropical Asian *Phanerosorus major* has a ribbon-like gametophyte which, as well as reproducing sexually, proliferates freely from the marginal cells of the thallus, leading to a colonial gametophytic mat. In consequence, many young sporophytes may arise from initially only a few spores.

FERTILIZATION AND EMBRYOGENY

Fertilization in the Polypodiales depends, as with most other archegoniate plants, upon the presence of water. The mucilage around the mouth of the archegonial canal, possibly because it contains traces of malic acid (known to possess

chemotactic properties), attracts the spermatozooids and effectively confines them to the region of the archegonia. Several spermatozooids commonly enter an open archegonium, and occasionally some can be seen to swim out again. Where crosses are attempted between certain genera (e.g., *Athyrium* ♀ × *Dryopteris filix-mas* ♂) the mucilage immobilizes the foreign spermatozooids and no hybrids are produced. Barriers to gametic fusion in ferns are so far little studied. It is possible that in some species self-fertilization is prevented, or its chances lessened, by incompatibility mechanisms in the archegonial mucilage or at the surface of the egg, but the evidence so far is inconclusive. It appears, however, to be a general rule that only one spermatozoid enters the egg, although others may be seen pressed against its surface.

Division of the zygote follows about 48 hours after fertilization. Experiments in which gametophytes of *Pteridium* containing maturing eggs have been fed with radioactive (tritiated) thymidine (which is incorporated into replicating DNA) have shown that the nucleus of the zygote enters mitosis without further DNA synthesis. This indicates that the nucleus of the egg, and presumably that of the spermatozoid, each contain the replicated (2C) amount of DNA. The zygotic nucleus is therefore *ab initio* in the G2 phase of the mitotic cycle, with the 4C amount of DNA of the diploid nucleus. It is consequently able to divide mitotically as soon as the cell is re-organized following the disturbance of gametic fusion.

The first vertical wall is succeeded by a horizontal so that in lateral aspect the zygote appears divided into quadrants. These quadrants indicate in a general way the course of the subsequent embryogeny. The upper anterior region, for example, goes to form the apex of the new sporophyte, the lower anterior the first leaf, while the posterior regions give rise to the first root and the foot (Fig. 7.44). There is no suspensor. Following fertilization, possibly a consequence of growth-regulating substances coming from the zygote, the growth of the gametophyte diminishes and the initiation of archegonia ceases. At the same time the cells of the archegonium immediately above the fertilized egg proliferate, forming a conspicuous cap (calyptra).

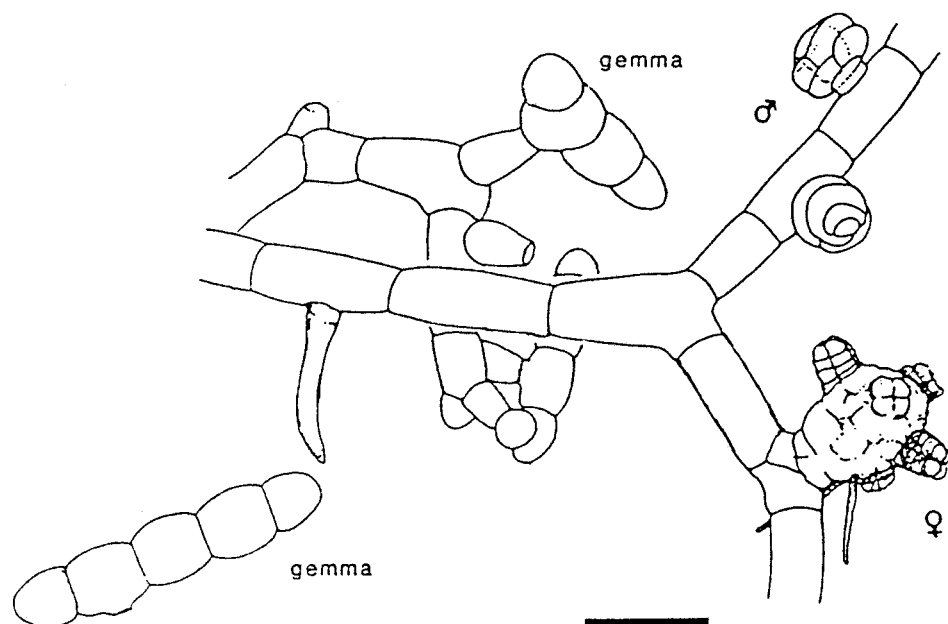

Figure 7.43 Portion of a filamentous gametophyte of *Trichomanes speciosum* growing in culture, showing the production of gemmae (terminating sterigmata) and sex organs. Partly diagrammatic. Scale bar 100 μm . (After Rumsey, 1994. PhD dissertation, University of Manchester.)

The foot of the embryo remains surrounded by a thickened boundary in which parts of the acetylation-resistant membrane originally surrounding the egg can be clearly seen in section. The apposed walls of the cells at the interface of gametophyte and sporophyte develop a labyrinthine structure. Although these cells have been termed “transfer cells”, the term is misleading and should be abandoned. Experiments with radioactively labelled, potentially informational, molecules, such as nucleosides, have shown that these molecules do not traverse the gametophyte/sporophyte boundary. The wall labyrinth appears therefore to be acting in respect of some metabolites as a molecular filter. “Transfer cells” at sites such as the gametophyte/sporophyte interface are better regarded as a developmental feature brought about by an active flux (no doubt containing “innocuous” metabolites, such as sugars) into the growing embryo through amorphous mucopolysaccharides accumulating (as part of a quasi “defense reaction”) at the apposed faces of the dissimilar generations. The situation

is clearly similar to that obtaining in the bryophytes (p. 103).

Experiments have shown that the calyptra formed above the zygote, probably by exerting mechanical pressure on the developing embryo, plays an important part in modulating normal embryogenesis, again recalling the situation in the mosses (p. 125). If the calyptra is removed from above a very young zygote, the zygote gives rise to a mass of parenchymatous tissue before producing differentiated growing points. With cordate gametophytes, an intact apical meristem, probably in consequence of the auxin it produces, is also essential for normal embryogenesis. If this meristem is destroyed, differentiation of the embryo is markedly slower and the emergence of the first root very much delayed.

Information, probably in the form of messenger RNA, leading to the initiation of normal embryogenesis appears to be already present in the cytoplasm of the mature egg cell. If this RNA is corrupted by allowing the egg to mature in the presence of a sublethal concentration of the uracil analog thiouracil, the zygote, formed following fertilization with a normal spermatozoid and the immediate transfer of the gametophyte to a thiouracil-free medium, gives rise to an embryo which quickly reverts to gametophytic growth. This provides a very satisfactory demon-

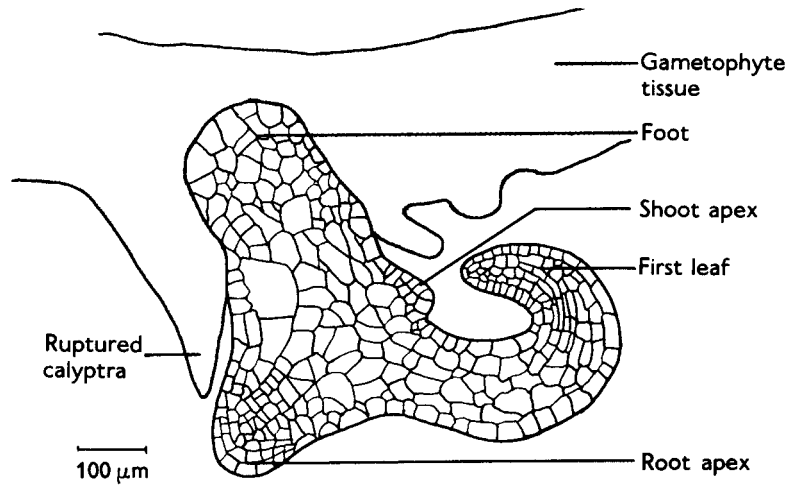

Figure 7.44 *Pteridium aquilinum*.
Vertical section of embryo.

fectly formed and functional, and are capable of fertilizing eggs of related sexual species. Subsequently, however, in place of archegonia, a sporophyte develops directly from the subapical region of the gametophyte. The cellular mechanisms underlying this kind of life cycle are not yet understood. The condition is however known to be genetically dominant since hybrids

stration of the rôle of RNA in the control of morphogenesis.

It seems highly likely that intragametophytic selfing occurs not infrequently in fern populations. Some experiments have failed to demonstrate deleterious effects of such selfing, but a long-term experiment with *Athyrium filix-femina* has clearly brought out the greater fitness of the progeny of intergametophytic mating. In natural populations, the progeny of intragametophytic mating are probably eliminated at an earlier stage than their heterozygous neighbors.

Aberrations of the fern life cycle are not uncommon. Apogamy, the production of a sporophyte without sexual fusion, occurs regularly in some ferns and can be induced experimentally in others. *Dryopteris affinis* subsp. *affinis* (*D. borrieri*) provides an example of a regular apogamous cycle (Fig. 7.45A). In this and similar species the final mitosis of the sporogenous cells is incomplete. Following division of the chromosomes the nucleus re-forms. The cell remains undivided, although it has grown considerably as if a normal division were about to occur. Instead it becomes a spore mother cell. The restitution nucleus, which has twice the sporophytic number of chromosomes, enters meiosis. The four spores produced, reflecting the large size of the spore mother cell, have diameters of about 80 μm , and contain nuclei with the same number of chromosomes as the parent sporophyte. The spores germinate in the normal way and the gametophytes pass through a male phase. The spermatozoids are per-

with sexual species have the same kind of apogamous cycle. Ferns such as *D. affinis* subsp. *affinis* are said to be **agamosporic**; it is estimated that 10 percent of homosporous ferns have a cycle of this kind.

Another, much rarer, form of apogamous cycle is found in a few ferns. Here it is the first meiotic division which fails, but the end result is the same, 32 spores being produced in place of 64 (Fig. 7.45B). The spermatozoids produced by the gametophytes of these ferns are sluggish and probably inactive. The heritability of this form of cycle has not been established.

Experimentally, apogamy can sometimes be induced by withholding water from gametophytes and preventing sexual reproduction. Sporophytes have been raised in this way from gametophytes of *Dryopteris filix-mas* and *Dryopteris dilatata*. In *Pteridium* in pure culture apogamous outgrowths are promoted by a high level of sucrose. Such experimentally produced sporophytes are often depauperate, and if they reach meiosis fail to produce viable spores. They naturally lack the pre-meiotic doubling of the chromosomes characteristic of the *D. affinis* kind of cycle.

The direct production of gametophytes from sporophytes (apospory) can be very readily induced in culture by placing fragments of juvenile leaves in sterile conditions on an agar medium. The gametophytes are usually sexually perfect and yield tetraploid sporophytes. This phenomenon may occur sporadically in the wild and lead to the production of natural autopolyploids.

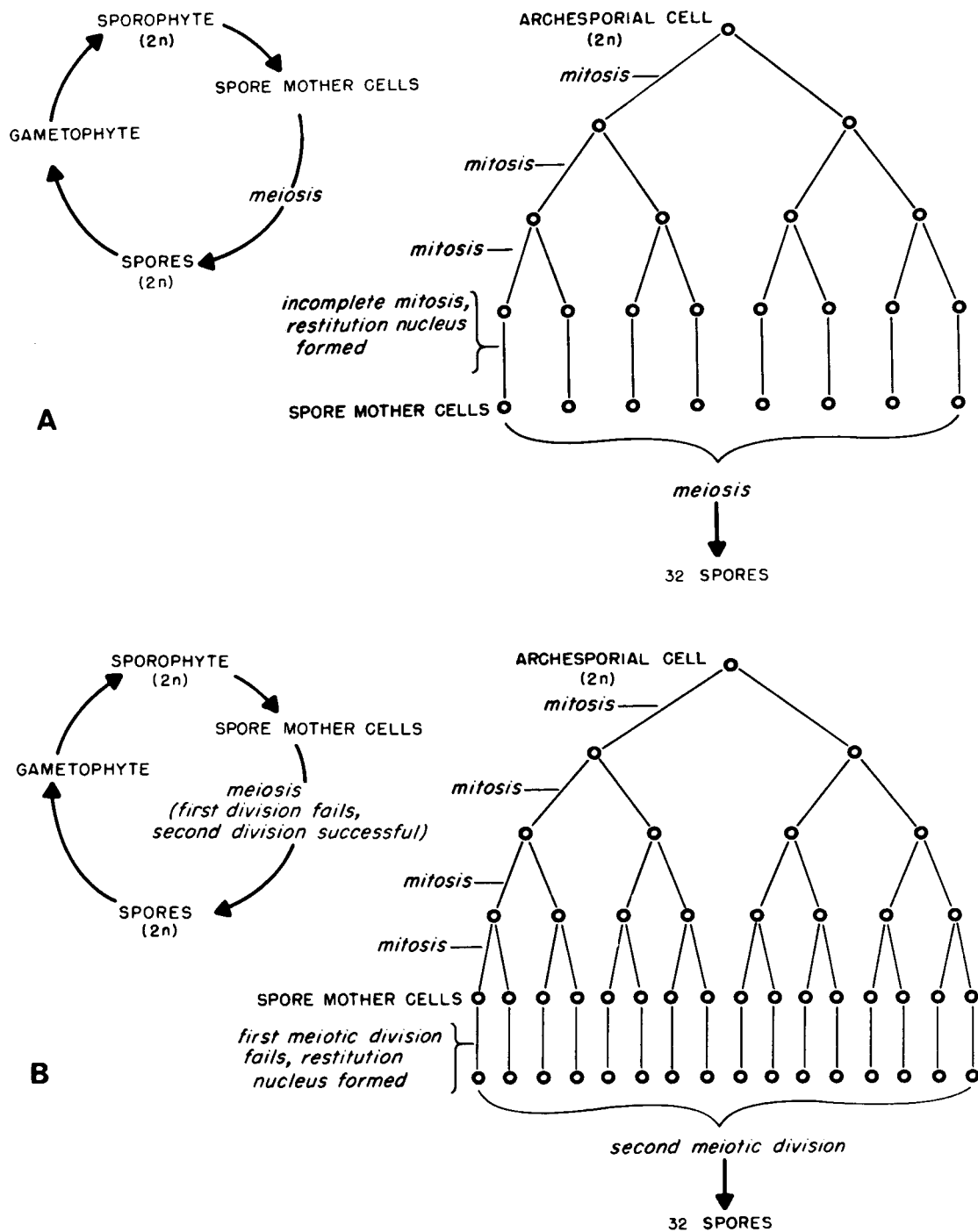

Figure 7.45 Apogamous life cycles in ferns. (A) As in *Dryopteris affinis* subsp. *affinis*. (B) As in *Asplenium aethiopicum*. (From Klekowski, 1973. *American Journal of Botany* 60, modified.)

Autopolyploids may also arise (probably more usually) by chance failure of reduction in meiosis.

EVOLUTION

The evolutionary relationships of the living Polypodiales can be studied at two levels. First, by carrying out crosses between living species and examining the pairing behavior of the chromosomes at meiosis we can obtain evidence of the extent of the genetic identity between them. Second, by comparing the morphology and anatomy of living species with the fossil we can obtain a general impression of the evolution of the contemporary fern flora.

Studies of chromosome homologies at meiosis, facilitated by the ease with which squash preparations can be made of developing sporangia, have shown that many familiar species are of hybrid origin. *Dryopteris filix-mas*, for example, is an allotetraploid probably derived from a hybrid between two diploid ancestors, one similar to *D. oreades* (*D. abbreviata*) and the other to *D. caucasica*. Particularly interesting is that widespread forms of some species are autotetraploids. A familiar example is the subspecies *quadri-valens* of *Asplenium trichomanes*. Other species are possibly tetraploid in origin, but isozyme analysis shows that they behave as diploids. Representative of this situation is the common *Pteridium* ($n=52$). Selfing experiments with *Pteridium* have nevertheless revealed considerable genetic variation in the progeny. This may arise from recombination between duplicated unlinked loci in homoeologous chromosomes (*homoeologous heterozygosity*), and would be in line with the view that, despite the enzyme results, the species is ancestrally tetraploid. Hybridization and duplication of chromosome number undoubtedly account for much of the diversity in living ferns, but provide for little profound anatomical or morphological change.

The development of techniques involving the polymerase chain reaction (PCR), allowing the amplification of minute quantities of DNA, has enabled the investigation in depth of the chloroplast genome, providing yet another approach to problems of recent phylogeny. In *Asplenium*, for example, comparison of the lengths of a non-coding intron in the chloroplast DNA has facilitated a clear understanding of the parental

relationships of a range of hybrids of *A. septentrionale* and *A. trichomanes* (known collectively as *A. alternifolium*). The molecular evidence, coupled with the knowledge from ultrastructural studies that the fully developed spermatozoids of ferns lack plastids, point conclusively to *A. septentrionale* having acted predominantly as the female parent. This unidirectional hybridization can be related satisfactorily to the ecology and phenology of the gametophytes of the parent species.

By contrast, the study of the fossil Polypodiales has given valuable information about the evolutionary status of the present-day families. The Schizaeaceae, for example, have a well-established fossil history, possibly extending back to the Paleozoic, although the oldest undisputed representative of the family is *Klukia* from the Jurassic. *Tempskya* (Fig. 7.46), one of the strangest fern fossils, has been assigned to the Schizaeaceae. Known only from stem fragments of Cretaceous age, it is believed to have been a small tree fern with a composite trunk consisting of numerous ramifying axes bound together by adventitious roots. The branching crowns of some Osmundales approach a similar structure. Some authors prefer to place *Tempskya* in a separate family (Tempskyaceae). The Gleicheniaceae have a history similar to that of the Schizaeaceae, again becoming relatively abundant in the Mesozoic. Other families, such as the Matoniaceae, first appear in the Mesozoic. Nevertheless, despite these evidences of antiquity, most of the living Polypodiales either have no fossil record, or no record extending back further than the Tertiary. This is particularly true of the large family Polypodiaceae, and we must suppose that these ferns are comparatively recent, probably having evolved toward the end of the Cretaceous period and subsequently.

Comparison of the living Polypodiales with the fossil, quite apart from tracing particular lineages, also reveals those features which can be regarded in a general way as primitive. Protostelic and solenostelic vascular systems, the simultaneous production of the sporangia in the sori, short thick sporangial stalks, the indurated cells of the sporangial wall aggregated laterally or arranged in a transverse annulus, and a large number of spores in each sporangium are all features of the

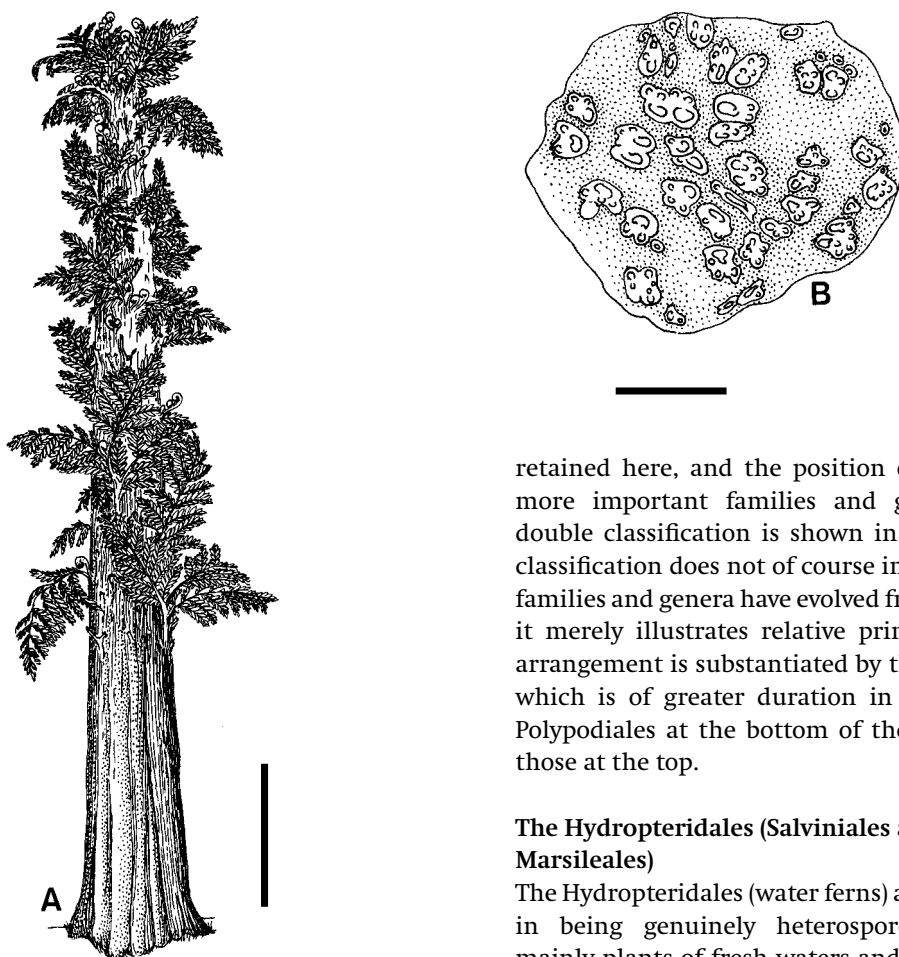

Figure 7.46 (A) Reconstruction of *Tempuskyia*. Scale bar 1 m. (B) Transverse section of composite trunk. Scale bar 20 cm. (From Stewart and Rothwell. 1993. *Paleobotany and the Evolution of Plants*, 2nd edn. Cambridge University Press, New York.)

early Polypodiales. Conversely, dictyosteles, the production of mixed sori, long and delicate sporangial stalks, vertical annuli, and low spore numbers are all features of Polypodiales with little or no fossil record.

On the basis of these criteria it is possible to assign the families of living ferns to three grades according to their evolutionary advancement. It is also possible to arrange them in two series, according to whether the sporangia are marginal or superficial in origin, but recent research has thrown considerable doubt upon the significance of this feature. Nevertheless, it is tentatively

retained here, and the position of some of the more important families and genera in this double classification is shown in Table 7.1. This classification does not of course imply that living families and genera have evolved from each other; it merely illustrates relative primitiveness. The arrangement is substantiated by the fossil record which is of greater duration in respect of the Polypodiales at the bottom of the table than of those at the top.

The Hydropteridales (Salviniales and Marsileales)

The Hydropteridales (water ferns) are outstanding in being genuinely heterosporous. Although mainly plants of fresh waters and swamps, some species are characteristic of sites subject to seasonal drying. Hydropterids of the family Marsileaceae have a creeping rhizome bearing subulate (Fig. 7.47), bifoliate or quadrifoliate leaves. Those of the family Salviniaceae are floating plants with short branching rhizomes. The leaves are shortly petioled or sessile. In *Salvinia* the surface of the upper leaves is made unwettable by a covering of waxy hairs; the lower leaves are submerged and much divided, taking the place of roots. In *Azolla* (Fig. 7.48) the leaves are minute and unequally two-lobed, the larger upper lobe floating and containing a mucilaginous chamber inhabited by the blue-green alga *Anabaena azollae*. The delicate roots of *Azolla*, being devoid of soil, are very suitable objects for the study of root growth. Serial sectioning reveals how the cell lineages derived from the three posterior faces of the apical cell generate the mature root.

Table 7.1 Classification of representative genera and families of living Polypodiales based on evolutionary development and origin of sporangia.

Features of evolutionary significance	Position of origin of sporangia	
	Marginal	Superficial
Numbers of spores per sporangium 2^7-8 ↑ Reduction in number of cells forming sporangial stalk ↑ 2 ⁵⁻⁶	<i>Pteridium</i> <i>Davallia</i>	<i>Dryopteris</i> <i>Polystichum</i> <i>Asplenium</i> <i>Athyrium</i> <i>Polypodium</i>
Steles, commonly dictyosteles. Sori mixed. Sporangia with vertical annuli interrupted at stalk		
Steles, dictyosteles or solenosteles. Sori gradate. Sporangia with oblique annuli	Hymenophyllaceae	Cyatheaceae
Steles, protosteles or solenosteles. Sori simultaneous. Indurated cells of sporangial wall aggregated, or in transverse on oblique annuli	Schizaeaceae	Gleicheniaceae

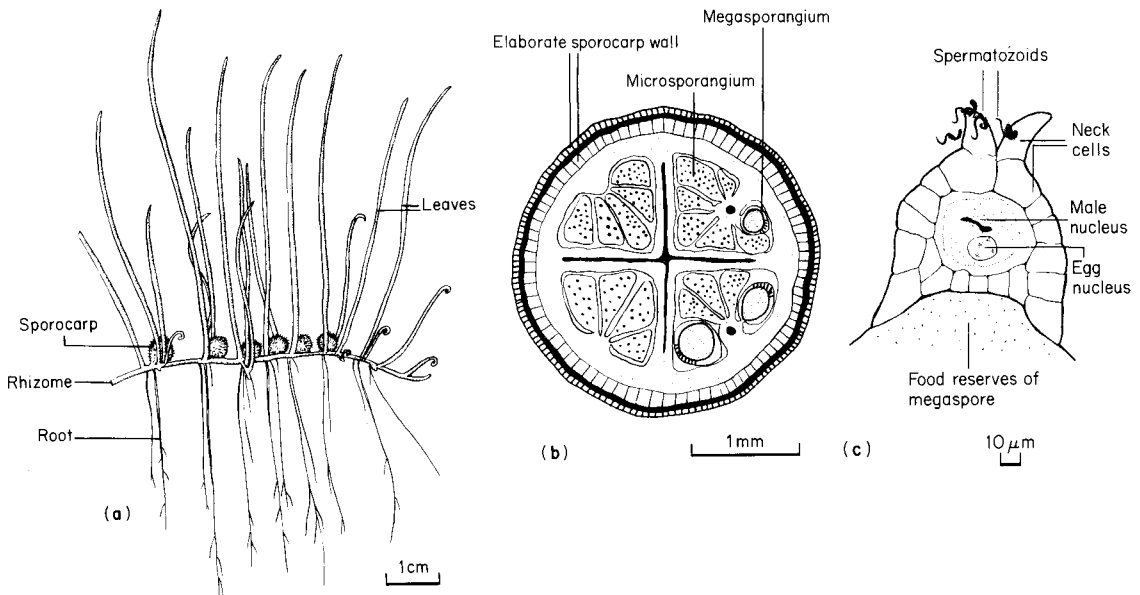

Figure 7.47 *Pilularia globulifera*. (a) Habit. (b) Transverse section of sporocarp showing the four sori. (c) Longitudinal section of in-seminated archegonium. ((a) after Hyde and Wade, 1940. *Welsh Ferns*. National Museum, Cardiff.)

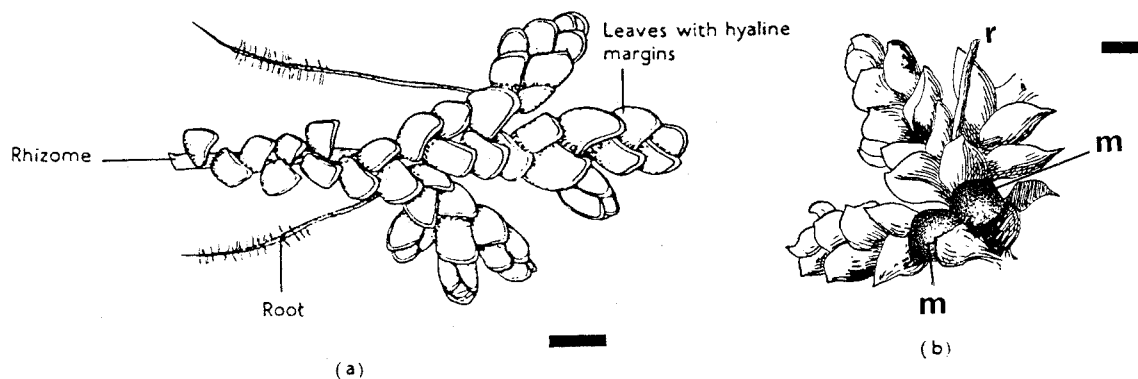

Figure 7.48 *Azolla filiculoides*. (a) Habit. (b) Lower surface of shoot showing a pair of microsporangial sori: m, microsporangial sorus; r, root. Accompanying sporulation (in temperate regions occurring toward the end of the growing season) the leaves often develop a reddish pigmentation. Scale bars 1 mm. (After Campbell, 1905. *The Structure and Development of Mosses and Ferns*. Macmillan, New York.)

Some hydropterids have economic value. In rice-growing areas *Azolla*, on account of its nitrogen-fixing symbiont *Anabaena*, is used extensively as a green manure. The vegetative parts of *Marsilea* yield a sedative used in Indian medicine, and the sporocarps are a source of starch.

REPRODUCTION

In *Pilularia* (Fig. 7.47), representative of the Marsileaceae, fertile pinnules are produced at the base of the petiole. They curve over the developing sporangia and become concrescent and eventually hardened, so producing the sporocarp. The ridge-like placenta bear megasporangia below and microsporangia above (although in *Marsilea* the positions are reversed). In *Azolla* (Salviniaceae) the sporangia develop on the submerged lower lobe of the leaf (Fig. 7.48b), microsporangia and megasporangia being produced in separate sori. The sporocarp is formed by an elaborate indusium which totally encloses the sorus. Sporogenesis in the hydropterids is similar to that in homosporous ferns, but in the megasporangia all but one of the potential megaspores are resorbed. Contrasting with the single megaspore in the mature megasporangium, the microsporangia typically contain 64 microspores.

The sporocarps of the Marsileaceae open only after the wall has weathered and been abraded

sufficiently to permit the entry of water. This may take years, but the viability of the spores declines only very slowly during this period of dormancy. When water eventually enters, the sori are carried out of the ruptured sporocarp by a worm-like expansion of the gelatinous remains of the fertile pinnules. The liberated spores germinate at once; the megaspore rapidly gives rise to a single archegonium surrounded by a few somatic cells (which may develop chlorophyll), while the microspores each produce a single antheridium containing 16 spermatocytes. Investigation of the spermatozooids of *Marsilea* has revealed that they have the same basic structure (Fig. 7.49) as those of the Polypodiales, although about twice the length. The mitochondrion entering into the structure of the helix is spectacularly large.

The sporocarps of the Salviniaceae open more readily than those of the Marsileaceae. In *Azolla* the megaspore is surrounded by four frothy massulae (Fig. 7.50) formed from the tapetum, and these give the liberated megaspore buoyancy, but it is doubtful whether they keep it afloat indefinitely. A variable number of massulae are formed in the microsporangium (Fig. 7.51). Each includes a number of microspores at its periphery, and is furnished externally with peculiar anchor-like glochidia. These male massulae hook themselves to the female, and the complex then sinks. Germination of the spores, in the main similar to that of the spores of the Marsileaceae, then follows. Embryogenesis is much more rapid in the heterosporous ferns than in the homosporous. Fertilization occurs within about 12 hours of the germination of the spores, and an embryo emerges from the archegonium on the following day.

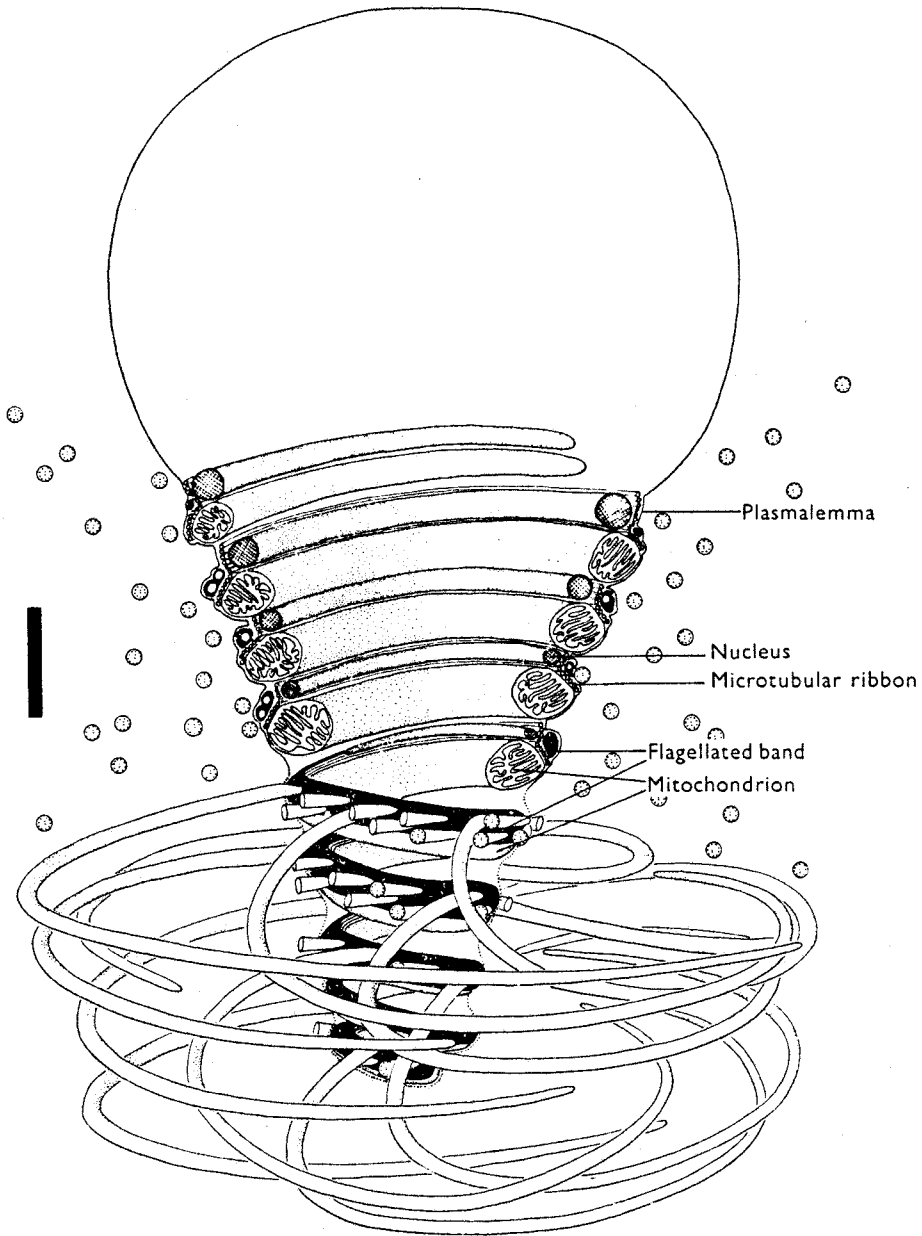
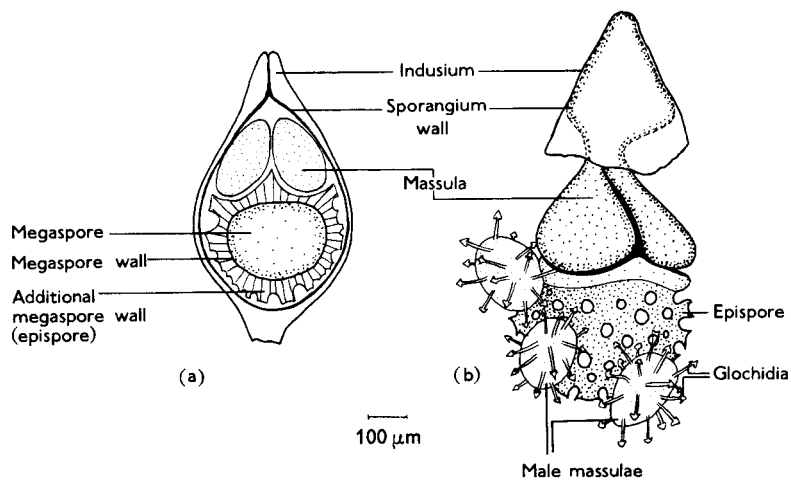

Figure 7.49 *Marsilea vestita*, spermatozoid. Drawing based on observation of living gametes and electron micrographs. The prominent mitochondrion, if straightened, would reach a length of approximately $75\ \mu\text{m}$. The plasmalemma at the posterior of the cell is shown in its expanded, bladder-like, form following shedding of the terminal vesicle containing plastids and small mitochondria. Scale bar $1\ \mu\text{m}$. (From Myles and Bell, 1975. *Journal of Cell Science* 17.)

Figure 7.50 *Azolla filiculoides*. (a)

Longitudinal section of megasporangium. (b) Liberated megaspore with male massulae attached. (After Strasburger. 1873. *Über Azolla*. Abel, Leipzig.)

**Figure 7.51** *Azolla filiculoides*. (a)

Longitudinal section of young microsporangial sorus. (b) Transverse section of mature microsporangium. ((a) after Campbell. 1905. *The Structure and Development of Mosses and Ferns*. Macmillan, New York; (b) after Smith. 1955. *Cryptogamic Botany*, vol. II. McGraw-Hill, New York.)

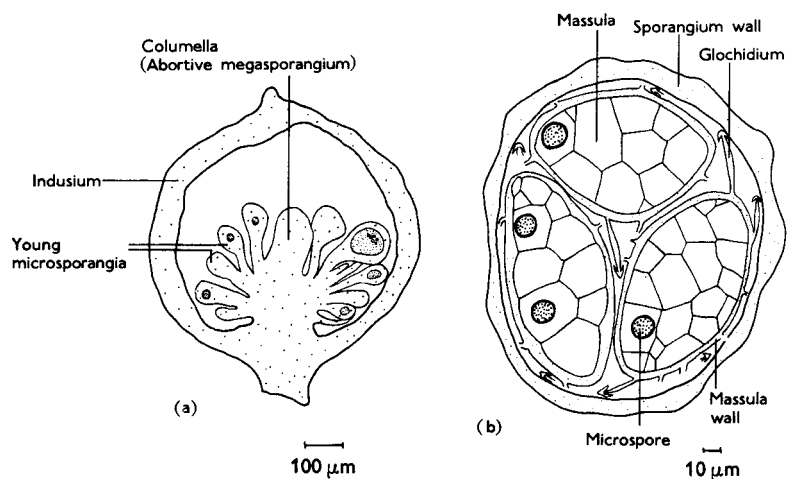

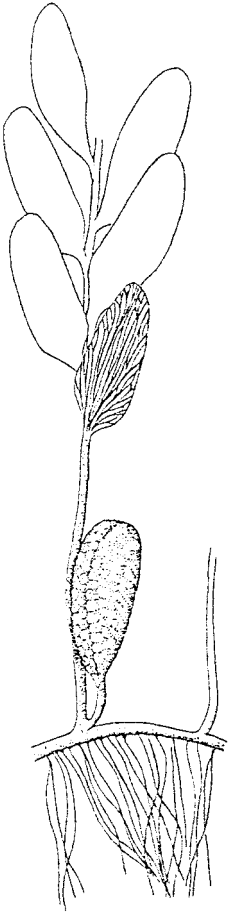

Figure 7.52 *Hydropteris pinnata*, reconstruction. Scale bar 5 mm. (From Rothwell and Stockey. 1994. *American Journal of Botany* 81.)

ORIGIN

The origins of the hydropterid ferns are altogether obscure. Although the fossil record of the Marsileaceae is meager, remains of reproductive parts resembling those of *Azolla* are identifiable as far back as the Lower Cretaceous. Compressed branching systems of *Azolla*, often with reproductive structures, are known from the Upper Cretaceous. Recent fossil evidence has yielded a possible common ancestor for the two families. *Hydropteris* (Fig. 7.52), from the late Cretaceous, had a marsileacean morphology but salvinia-cean reproductive features, seemingly closely linking these two families. The introduction of *Hydropteris* as a generic name validates the use of Hydropteridales as the name of the order containing the water ferns.

The subkingdom Embryophyta (cont.): division Tracheophyta, Part 3

Primitive ovulate plants and their precursors (Progymnospermopsida)

The class Progymnospermopsida contains only fossil plants. The concept of progymnospermy, a stage at which plants with conifer-like anatomy and morphology were still reproducing by spores, followed the surprising discovery that certain well-preserved trees of the Upper Devonian bore frond-like sprays of branches, some of which bore clusters of sporangia. *Callixylon*, the first progymnosperm to be recognized, provides a splendid example of this stage of evolution (Fig. 8.1a). The trunks reached a diameter of 1.5m (5ft) and a length of 8m (26ft) or more. Permineralized remains reveal fine details of the anatomy. A central pith was surrounded by mesarch primary xylem. Outside this lay a considerable thickness of well-developed secondary xylem traversed by narrow rays. The pits in the radial walls of the tracheids were frequently grouped, the groups aligned horizontally and in register with tracheids in the rays. Dense wood of this kind, also characteristic of modern conifers, is termed *pycnoxylic*.

Although *Callixylon* was known for many years as the trunk of a late Devonian tree, only much later were discovered specimens in organic connection with frond-like branches. These branches were already known as *Archaeopteris* and had been assumed to be the fronds of ferns. *Archaeopteris* is known both sterile and fertile (Fig. 8.1b). The sporangia were spindle-shaped, up to 3.5mm (0.14in.) in length, and occasionally with stomata in the epidermis. Heterospory occurred in some species, the microspores being 30–70 μm and the mega-

spores 150–500 μm in diameter, the two classes of spores being borne in separate sporangia.

Amongst other plants assigned to the progymnosperms are *Aneurophyton* (Aneurophytales), known from the Middle and Upper Devonian of Europe and North America, and *Protopitys* (Protopityales) from the Lower Carboniferous of Scotland. The axes of *Aneurophyton* contained a core of primary xylem, triangular in section, surrounded by secondary wood. The spirally arranged branches dichotomized two or three times, some terminating in tassels of sporangia. *Aneurophyton* appears to have been homosporous. The abundant pycnoxylic wood of *Protopitys* indicates that it is the remains of a tree. The branches were distichously arranged and sporangia were borne in small terminal clusters. The diameter of the spores lay between 80 and 160 μm . *Protopitys* was probably heterosporous.

The progymnosperms, which first become recognizable in the Middle Devonian and extend to the Lower Carboniferous (and possibly later), represent a significant intermediate stage in the evolution of the land flora. The notion that the frond originated from a lateral branch system (p. 172) is clearly supported by *Callixylon* and *Archaeopteris* (Archaeopteridales). Anatomically the pycnoxylic wood of the progymnosperms is strikingly modern in appearance, and some forms show clear examples of a bifacial cambium producing files of secondary phloem at its outer face. Further, gymnospermous reproduction presumably arose from heterosporous of the kind seen in many progymnosperms, although seeds are known almost as old as the progymnosperms (see p. 219).

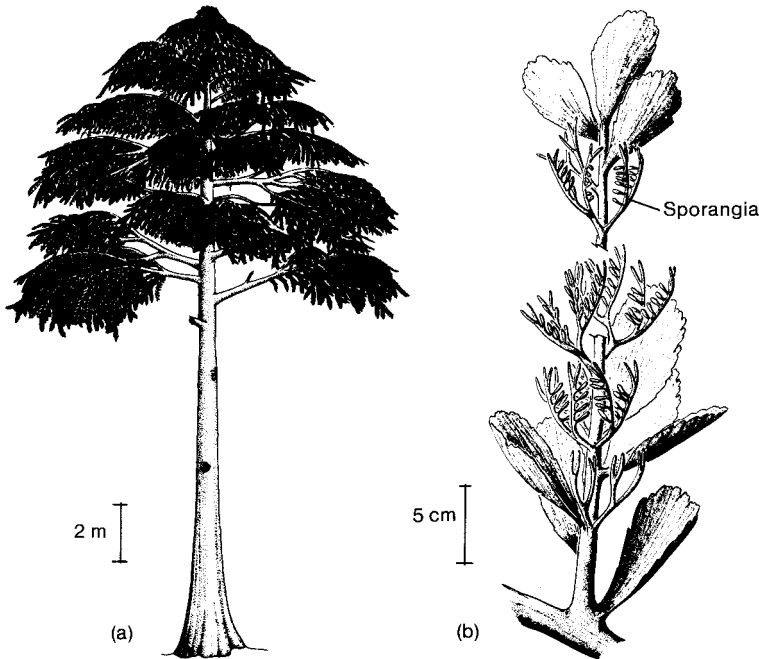

Figure 8.1 (a) *Callixylon* (*Archaeopteris*), reconstruction. (b) *Archaeopteris halliana*. Reconstruction of branch with sterile leaves and fertile appendages. (After Phillips, Andrews and Gensel, from Stewart, 1983. *Paleobotany and the Evolution of Plants*. Cambridge University Press, Cambridge, New York.)

present, consisting of tracheids (in a few forms also of vessels) and sieve cells. Sporangia borne on specialized structures, probably of axial origin. Heterospory general. Megasporogenesis occurring within a specialized tissue (nucellus), this in turn surrounded by a distinctive sheath (integument), the whole

termed the ovule. Neither male nor female gametophytes autotrophic. Fertilization by multiflagellate spermatozoids, or by male cells with no specialized means of locomotion, occurring within the ovule, either before or after its being shed. Embryogeny endoscopic, the embryo remaining contained within the seed developed from the ovule.

One of the most fully investigated of the early gymnospermous seeds is *Archaeosperma* (Fig. 8.2a and b) from the Upper Devonian of Pennsylvania. Here the nucellus (megaspore) was surrounded by an integument. This was deeply lobed above, revealing radial symmetry. The single functional megaspore was surmounted by three abortive spores. Their triradiate markings show that the tetrad had tetrahedral symmetry. Megasporogenesis in *Archaeosperma* thus resembled that in heterosporous ferns such as *Pilularia* and *Marsilea* (p. 214). In *Xenotheca* (Fig. 8.2c), another early Devonian seed, the integument was even more deeply lobed above than in *Archaeosperma*.

Little is yet known of the plants which bore the Devonian seeds. Knowledge of the early Carboniferous gymnosperms, although fuller than that of the late Devonian representatives, also remains limited. It seems likely, however, that

SPERMATOPHYTINA (seed plants): GYMNOSPERMS

The seed habit, the formation and retention of the embryo within an integumented megasporangium, is evidently of great antiquity. In paleobotany the term “seed” is also used for fossilized ovules, the later stages of seed formation being inferred. In general the early seeds of the Paleozoic terminated axes, and were either bilaterally symmetrical (*platyspermic*) or radial (*radiospermic*). Examples of each are known from the late Devonian. Very similar seeds are borne by some living plants. Together, the living and fossil forms constitute the gymnosperms, a name which implies that the seeds are naked, unenclosed in any carpellary structure. The fossil record indicates clearly that gymnospermy is the most primitive form of the seed habit.

Although a diverse division with possibly more than one origin from the early land plants, the general characteristics of the gymnosperms (not all being represented in the fossil forms) can be summarized as follows:

Sporophyte usually arborescent; branching and leaves various. Secondary vascular tissue always

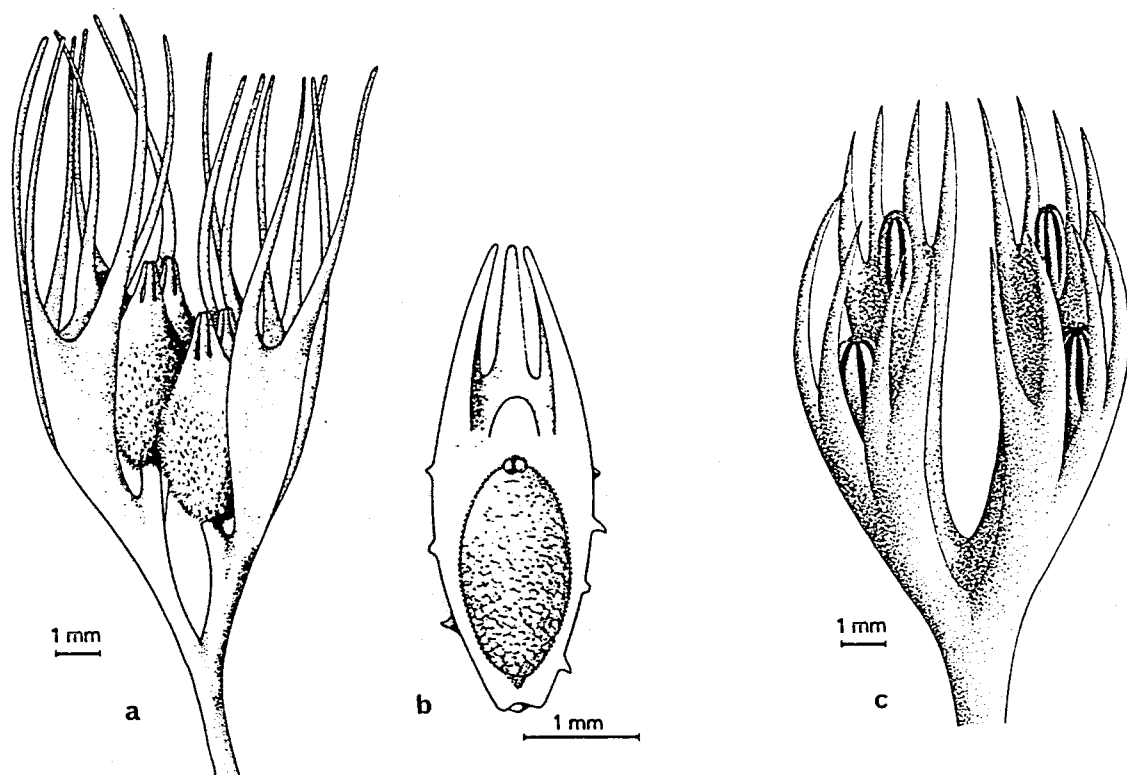

Figure 8.2 *Archaeosperma arnoldii*. (a) The two-seeded cupules were borne in pairs, the two pairs of seeds facing each other. (b) Reconstruction of an individual seed showing the three abortive megaspores at the top of the one which is functional. The integument is deeply lobed above. (c) The primitive *Xenotheca devonica*, showing even deeper lobing of the integument, exposing the upper part of the nucellus. ((a), (b) after Pettitt and Beck, 1968. *Contributions from the Museum of Paleontology, University of Michigan* 22; (c) after Hilton and Edwards, in Kurmann and Hemsley (eds.) 1988. *The Evolution of Plant Architecture*. Royal Botanic Gardens, Kew.)

some were impressive trees. *Pitys* (*Pitys*), for example, almost certainly a gymnosperm, had enormous trunks, reaching in some instances a diameter of 2 m (6.5 ft). Later in the Carboniferous remains become sufficiently numerous for the recognition of distinct classes, of which two (Cycadopsida and Pinopsida) have descendants living today.

The Cycadopsida, of which few still exist, have a fossil record that can be linked to the Carboniferous Lyginopteridales and Medullosales (the extinct “seed ferns”) with which they share

radiospermy. By contrast, relatives such as the Gnetopsida, Bennettitales and Caytoniales reveal features which suggest an affinity with the angiosperms (Fig. 8.3). These groups may therefore be seen as representing a natural sequence from the most primitive to the most specialized seed plants. The Pinopsida (Coniferales, conifers) have an obscure origin, but quickly became distinct in their generally pycnoxylic wood, platyspermy, and simple, often needle-like leaves. Their relationship to the Ginkgoopsida is unclear, and judgment depends upon the relative emphasis placed upon vegetative as opposed to reproductive characters.

Early radiospermic gymnosperms

Lyginopteridopsida (Pteridospermopsida)

The Lyginopteridales

Investigators of the fern-like fronds found in Carboniferous rocks soon became aware that not all these were in fact referable to ferns. Some were

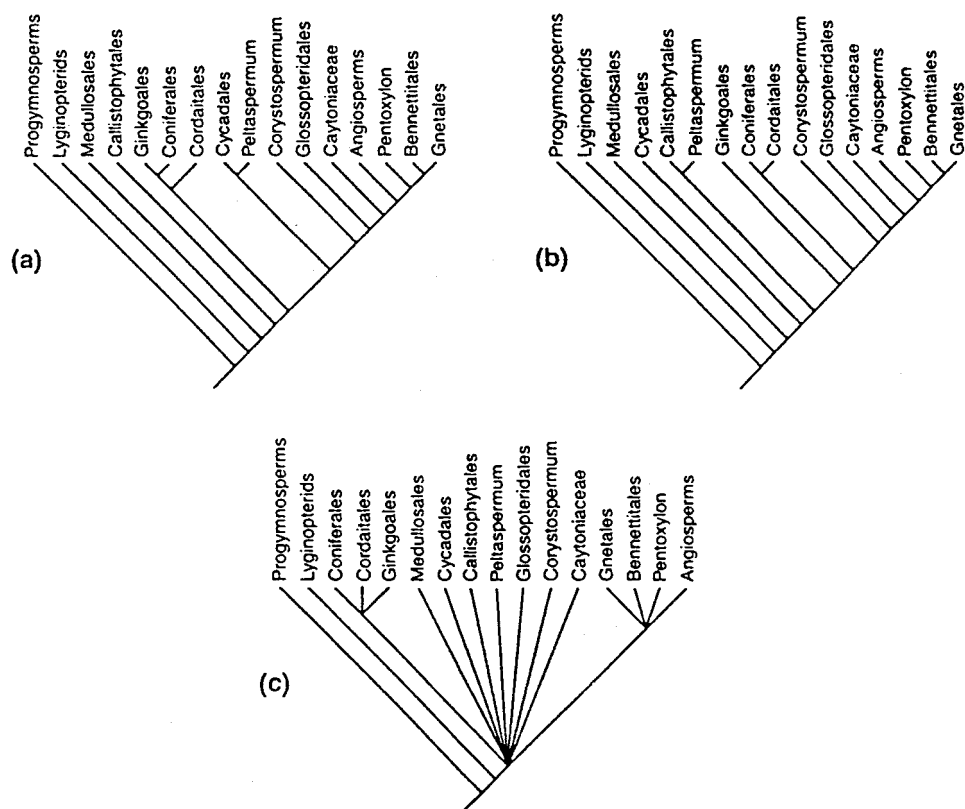

Figure 8.3 (a) and (b) Spermatophyte cladograms illustrating two of many equally likely trees. (c) A consensus tree (one in which an “average” of alternative cladograms of the seed plants is presented). The consensus tree indicates how poorly resolved the spermatophyte groups remain. ((a), (b) after Doyle and Donoghue, 1992. *Brittonia* 44; (c) after Crane, in Beck (ed.) 1988. *Origin and Evolution of Gymnosperms*. Columbia University Press, New York.)

undoubtedly associated with seeds, and others with stems in which there were secondary thickening and other anatomical features rarely found in the Polypodiopsida. Nevertheless, the habit of these plants was probably something like that of the Marattiales (p. 176). The leaves were megaphyllous, compound and pinnately branched, and borne on stems of varying height. Together they comprise the Lyginopteridales (Cycadofilicales), and are representative of the earliest Lyginopteridopsida (pteridosperms).

The features of the pteridosperm stem are well shown by the Carboniferous *Lyginopteris*. These well-preserved axes ranged in diameter from about 0.5 to 4 cm (0.2–1.6 in.), and occasionally

branched. There was a central pith, which contained nodules of thick-walled cells (similar to the groups of stone cells in the flesh of a pear), surrounded by a ring of primary xylem strands (Fig. 8.4). Exterior to these was a relatively large amount of secondary xylem. The tracheids of the secondary xylem, like those of the metaxylem, were furnished with bordered pits, but in the somewhat smaller tracheids of the secondary xylem they were absent from the tangential walls. A girdle of phloem, rarely well preserved, lay outside the xylem. A characteristic feature of *Lyginopteris* was the anatomy of the outer cortex. This contained radially elongated bands of fibers which anastomosed freely and clearly gave considerable mechanical support to the stem.

The leaves of *Lyginopteris* (originally described as *Sphenopteris*) were borne in a 2/5 phyllotaxy and when young showed circinate vernation. In mature leaves, which sometimes reached a length of 50 cm (19 in.), the rachis dichotomized at about half its length, but the remainder of the branching was pinnate and the ultimate segments were

Figure 8.4 *Lyginopteris oldhamia*.

Transverse section of stem. The glandular epidermis has been lost. The leaf trace divides into two strands in the cortex, but these reunite to form a V-shaped trace at the base of the petiole.

narrow pinnules. The outer surface of many parts of *Lyginopteris* was furnished with peculiar multicellular glands, a feature which has enabled paleobotanists to reconstruct the entire aerial part of the plant from disconnected fragments.

REPRODUCTIVE STRUCTURES

The female reproductive organs of *Lyginopteris* are also known in detail. The ovules (originally described as *Lagenostoma*) terminated axes which were probably branches of otherwise normal leaves. Each ovule (or seed) was partially enclosed in a cup formed by a number of glandular and basally fused bracts (Fig. 8.5a). This structure, called a *cupule*, in some forms contained more than one ovule. The ovule itself was an upright, radially symmetrical structure, about 0.5 cm (0.2 in.) long and a little less broad. The central part (Fig. 8.5b), the nucellus, possibly a specialized archesporial tissue, was surrounded by an integument of two layers, the outer of which contained a sclerenchymatous sheath. A single vascular bundle entered the base of the ovule and divided symmetrically into nine parts which ascended the inner fleshy part of the integument. The upper part of the integument around the micropyle was shallowly lobed, the lobing corresponding to the intervals between the ascending veins. The nucellus was fused to the integument except at its summit. Here the apical portion ascended as a column, surrounded by a sheath of similar tissue (Fig. 8.5b). This specialized development of the upper part of the nucellus, probably serving as an effective pollen trap, is termed the *lagenostome*. Pollen grains are often observed in the

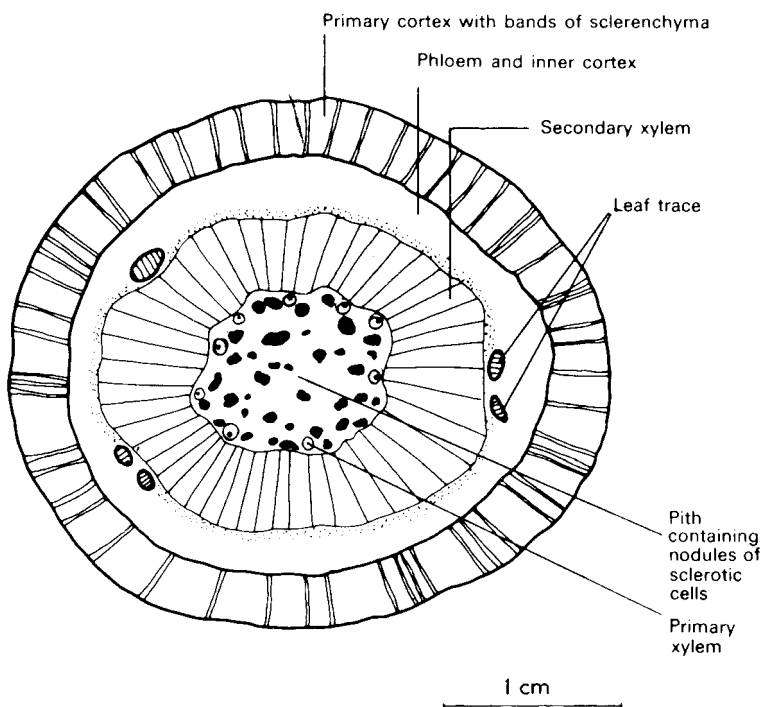

space between the base of the sheath and the column (referred to as the "pollen chamber"). Germination may have occurred here, but few details are yet known. A female gametophyte, surrounded by a distinct membrane and bearing archegonia at its upper surface, lay within the nucellus. This gametophyte probably developed from a megaspore, formed as one of a tetrad within the nucellus, the remaining megaspores degenerating.

The male reproductive organ of *Lyginopteris* is not yet identified with certainty. It is, however, very probable that it consisted of a small ovate plate, about 2 mm (0.08 in.) in length, terminating a branchlet and bearing about six or more bilocular sporangia (Fig. 8.6b). Each sporangium was about 3 mm (0.13 in.) long and 1.5 mm (0.06 in.) wide. The microsporangioophores were borne on a branch system (the whole being known as *Crossotheca*) which may have formed part of a *Lyginopteris* leaf (Fig. 8.6a).

The pollen grains (Fig. 8.6c), which bore triradial scars, were presumably distributed by wind. By analogy with the pollination of living gymnospermous ovules, it is thought the grains were trapped by a drop of sugary fluid which protruded

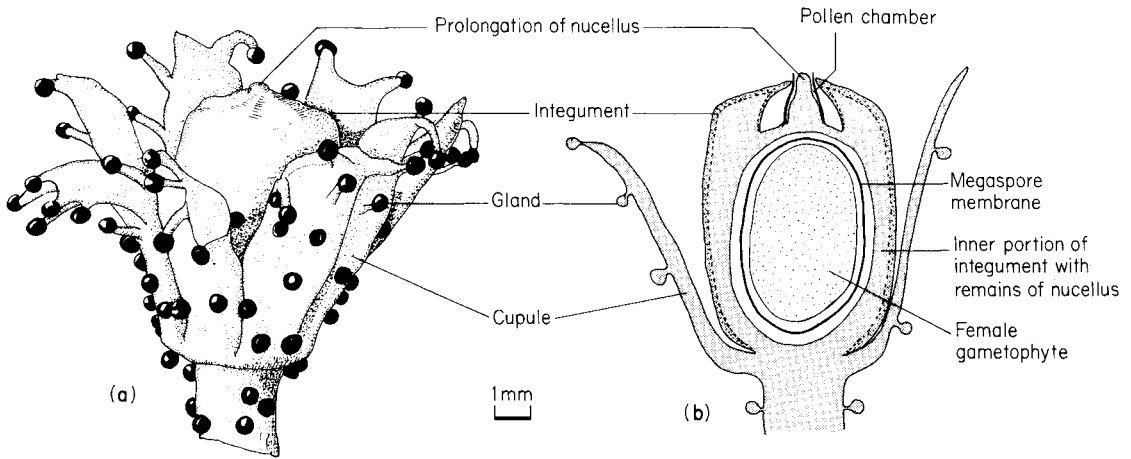

Figure 8.5 *Lagenostoma lomaxi*. (a) Reconstruction of seed and cupule. The heads of the glandular hairs are shown in black. (b) Longitudinal section of seed. ((a) after a drawing by F. W. Olive; (b) after Walton, 1940. *An Introduction to the Study of Fossil Plants*. Black, London.)

from the micropyle, and that subsequent absorption of this drop drew the grains down into the pollen chamber. Germination of the grains is thought to have been proximal (i.e., at the site of the triradiate scar, as with the spores of ferns and bryophytes). This contrasts with the regular distal germination of living conifer and angiosperm pollen. Pteridosperm pollen is accordingly often referred to as “pre-pollen”. The production of pre-pollen is thought likely to have been accompanied subsequently by zooidogamous fertilization.

Embryos have only rarely been found in pteridosperm seeds, and their absence is not readily explained. Megagametophytes with archegonia are not uncommon, and have been seen in the earliest seeds of the late Devonian.

ORIGIN

The pteridosperms probably had their origin in axial plants resembling the progymnosperms, the fronds again being derived from lateral sprays of branchlets. The radial symmetry of many pteridosperm seeds suggests that they may have evolved from tassels of megasporangia in which a central megasporangium became closely surrounded by a ring of similar megasporangia (Fig. 8.7A and B). Sterilization of the outer ring (Fig. 8.7C), but not of the center, would then have resulted in an inte-

gumented megasporangium. Although no intermediate stages in such a transformation have yet come to light, it is significant that in one of the earliest pteridosperm seeds from the Lower Carboniferous (*Salpingostoma*) the integument consists of a ring of finger-like processes, each containing a vein, fused only in the basal region. In such ovules, often termed “pre-ovules”, there was no clearly defined micropyle. Progressive fusion of components could nevertheless have led to the entire integuments of the pteridosperm seeds of the Upper Carboniferous (Fig. 8.7D), the shallow lobing often seen in the micropylar region of these integuments being the only remaining indication of their compound origin. Experiments with models have shown that the finger-like extensions of the integument seen in some of the early seeds may, by setting up local turbulence, have assisted in trapping wind-borne pollen above the nucellus. The development of the lagenostome, with its distinctive pollen chamber, at this site seems to have been a feature of the earliest radiospermic seeds, and may even have been present in remains of cupulate seeds found in the Upper Devonian. The lagenostome of the pre-ovule *Hydrosperma*, found in beds laid down at the Devonian–Carboniferous transition, has been studied in some detail. It seems likely that, following pollination, the floor of the pollen chamber rose, pushing up the central column so that its summit blocked the entrance to the chamber from above. In this way the chamber, *in vivo* probably containing a sugary secretion, became a sealed “culture sac” in which the pollen was able

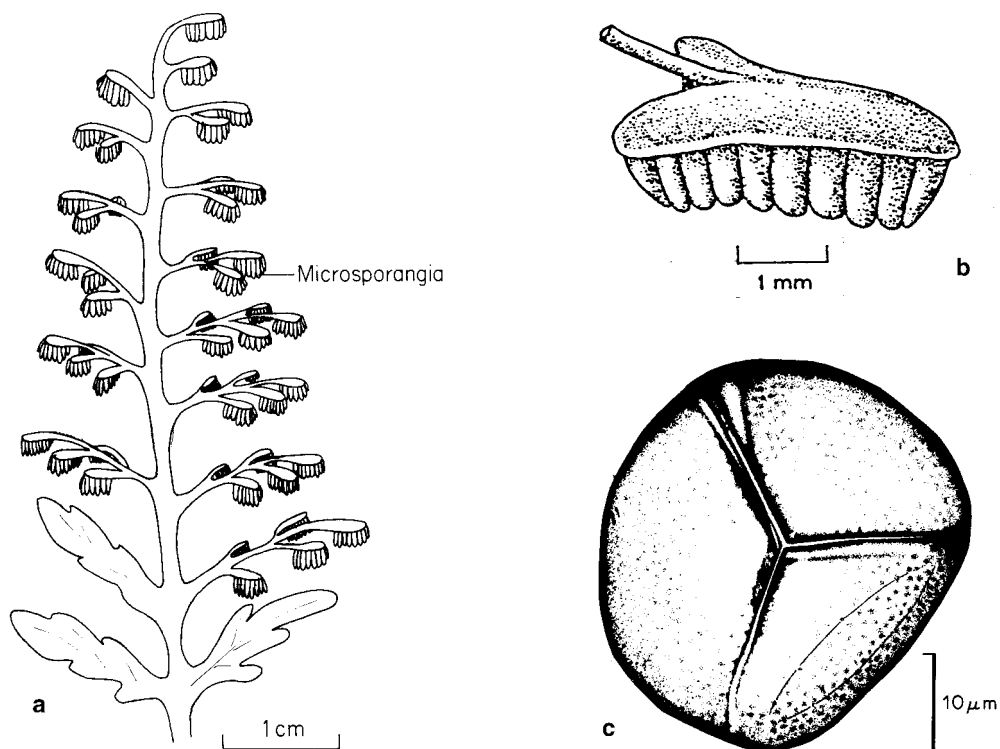

Figure 8.6 *Crossotheca*. (a) Reconstruction of fertile shoot. (b) Detail of the fertile pinnule of *Crossotheca sagittata*. (c) Microspore (pollen grain). The deep cleavage at the site of the triradiate scar indicates proximal germination. ((a) after Andrews. 1961. *Studies in Paleobotany*. Wiley, New York; (b) after Millay and Taylor. 1977. *American Journal of Botany* 64; (c) from a preparation by R. Kidston, photographed by W. G. Chaloner.)

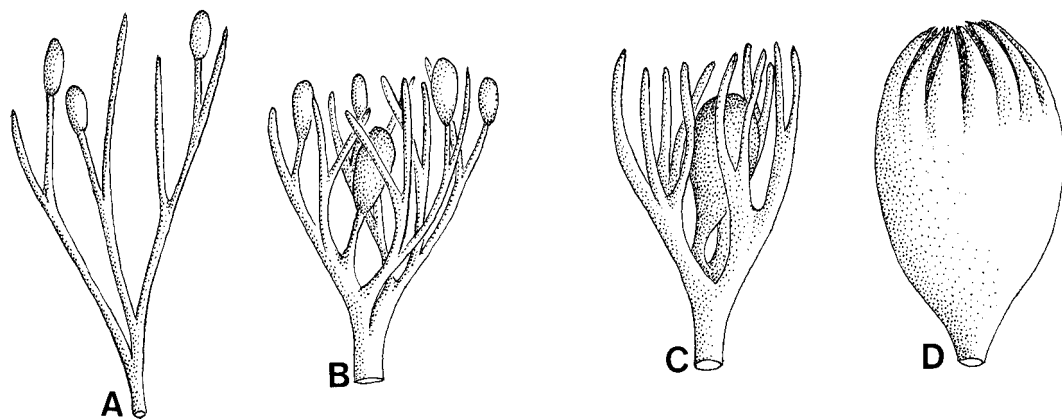

Figure 8.7 Diagrammatic representation of the derivation of an integumented lyginopterid ovule from a tassel of megasporangia. Further explanation in text.

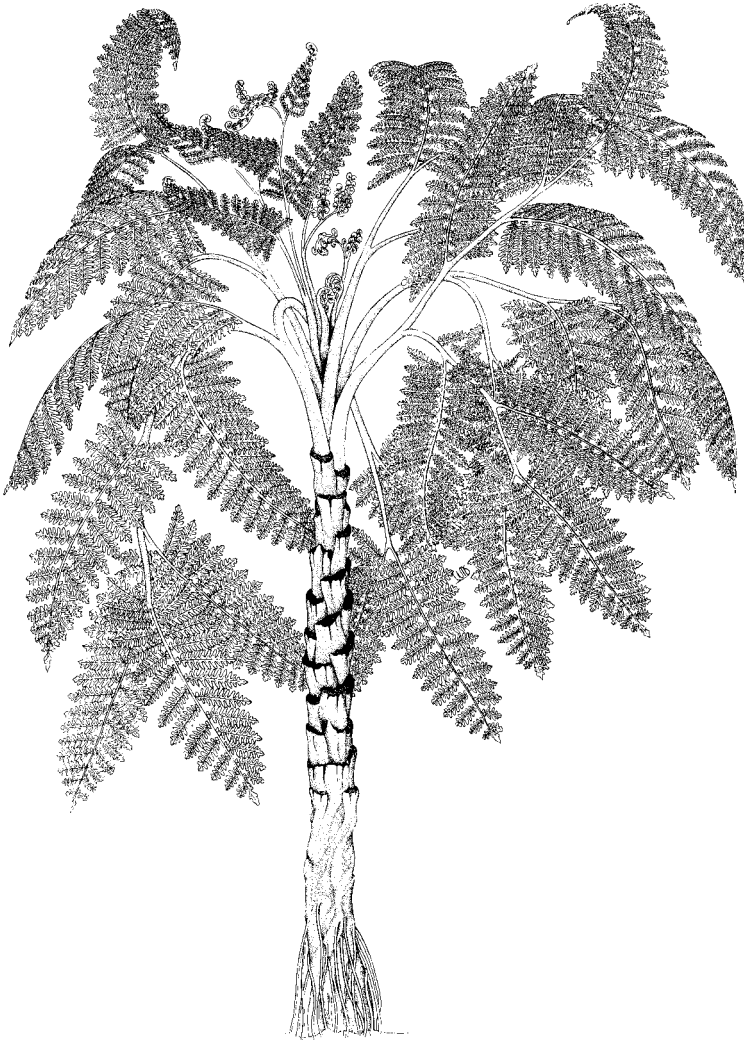

Figure 8.8 Reconstruction of *Medullosa*, based on *M. noei*. The plant reached a height of about 4 m (14 ft). (After Stewart and Delevoryas. 1956. *Botanical Review* 22.)

the end of the Paleozoic other, more complex, forms (of which *Medullosa* is representative) became prominent. They were more like tree ferns in habit (Fig. 8.8), sometimes possibly scrambling. The leaves had large petioles which bifurcated at some distance from the stem, resulting in a frond which consisted of two symmetrical halves. The subsequent branching was pinnate. The pinnules (as seen in *Alethopteris*, *Neuropteris* and other dispersed leaf genera) were conspicuously larger than those of the earlier pteridosperms. The anatomy of the stem was particularly complex, the xylem usually being split into several segments. In addition, axial bundles of primary xylem (called “sympodia”) were present at the outer

edges of these segments. Secondary wood, consisting of large tracheids and extensive rays, surrounded the primary. Secondary wood of this kind, which is relatively soft and spongy, is termed *manoxylic*. It is also found in some living gymnosperms, notably the cycads (p. 247). The leaf traces were also complex, each consisting of several strands. The strands comprising the trace for a single leaf originated from one or more of the sympodia.

to germinate. This “hydrosperman reproduction” is believed to have been widespread in the early radiospermic seeds.

The development of ovules containing single megaspores from progymnospermous megasporangia is unlikely to have been a smooth progression. The regular failure of three of the spores in the tetrad to develop (seen also in *Lepidocarpon*, Fig. 6.14) indicates precisely controlled events within the tetrad. This may have been the consequence of a relatively simple mutation, but clearly one of great significance in plant evolution.

The Medullosales

Lyginopteris is typical of a wide range of Carboniferous Lyginopteridopsida, but toward

The seeds, placed in the genus *Pachytesta*, were about six times the size of those of *Lyginopteris*, and were more clearly borne in association with foliar organs. They were distinctly trimerous and lacked a cupule (Fig. 8.9a and b). The microspores (pre-pollen), which were monoletic, were produced

Figure 8.9 (a) *Pachytosta* attached to *Alethopteris* foliage. The seed was about 40 mm (1.6 in.) long and 12 mm (0.5 in.) in width. (b) *Pachytosta illinoensis* in section: m, micropyle; pc, pollen chamber; n, nucellus; i, integument. (From Stewart and Rothwell. 1993. *Paleobotany and the Evolution of Plants*, 2nd edn. Cambridge University Press, New York.)

in large tubular sporangia, borne in fused clusters (synangia).

The descendants of the Lyginopteridopsida

The Lyginopteridales may well have given rise to the Callistophytales, a group of pteridosperms with a *Lyginopteris*-like stele, platyspermic seeds and saccate pollen. A callistophytalean ovule from the mid-Pennsylvanian (Table 1.1) has provided the best evidence yet for the existence, already in Paleozoic times, of a “pollination drop” mechanism for the capture of pollen (p. 237). The micropyle of the ovule was filled with material, which in life may have been a syrupy secretion, containing scattered pollen grains. The grains of some forms may have germinated distally. Clear indications of nuclear divisions have been seen within some grains, and also indications of pollen tubes. Although many of these features are suggestive of the Pinopsida, stratigraphic evidence precludes an origin of the Pinopsida from the Callistophytales. Like the Lyginopteridales, the Callistophytales became extinct at, or just after, the end of the Carboniferous.

It seems beyond doubt that some pteridosperms persisted into the early Mesozoic, although the remains become much less frequent after the close of the Paleozoic era and of an unfamiliar form. There is also evidence that the evolution of the pteridosperms in the northern and southern hemispheres diverged at this time, but the two floras remained in contact in certain regions of Africa. The early Mesozoic rocks of these regions have yielded a number of

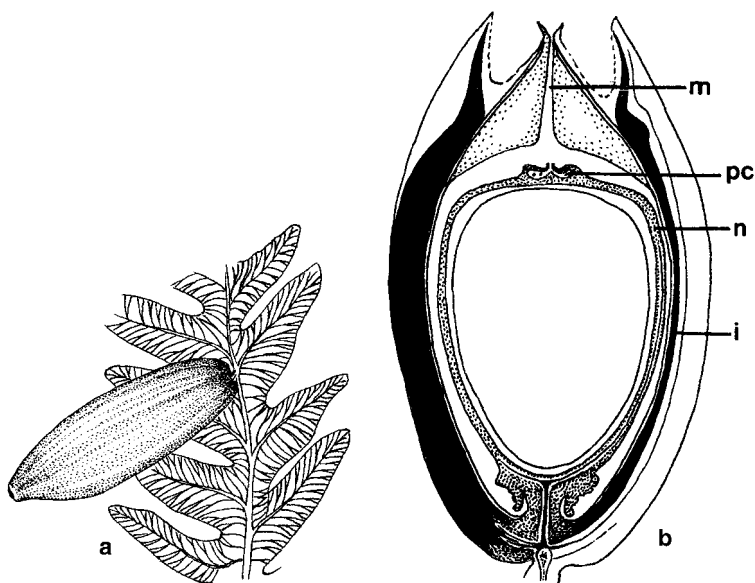

puzzling plants, almost certainly derived from the pteridosperms and probably of very great importance in the evolution of the later seed plants. Some of them had leaves with reticulate venation and an appearance strikingly like that of the leaves of some modern flowering plants. Others had seeds in partially closed cupules, a development possibly leading to the remarkable fruiting body of the Caytoniaceae (p. 254). Elsewhere, from a pteridospermic ancestor, most likely within the Medullosales, the earliest cycads appeared. The Glossopteridales (p. 255), Bennettitales (p. 252) and other radiospermic orders are also most probably descended from pteridospermic antecedents.

Platyspermic gymnosperms and pine relatives

Pinopsida

The Pinopsida have been distinct since their origin in the Upper Devonian/Lower Carboniferous. Their origin in relation to the Progymnospermopsida and Pteridospermopsida remains wholly uncertain. Pycnoxylic wood, platyspermy and parallel-veined leaves have been features characteristic of the Pinopsida since the Cordaitales of the Carboniferous.

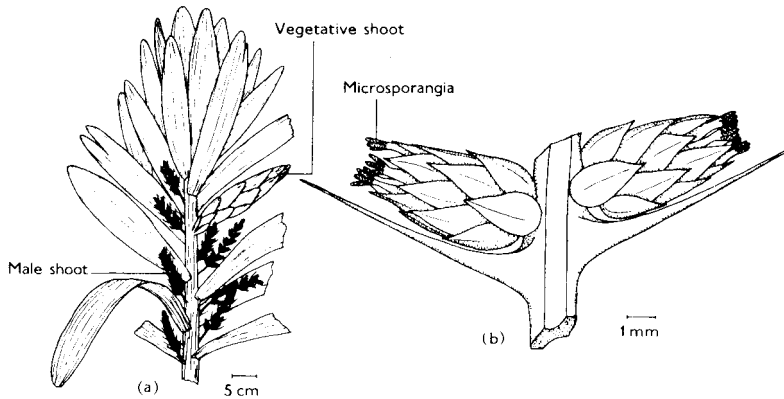

Figure 8.10 (a) Reconstruction of a cordaitalean shoot. (b) *Cordaianthus concinnus*. Reconstruction of two male shoots. ((a) after Grand'Eury, from Andrews, 1961. *Studies in Paleobotany*. Wiley, New York; (b) after Delevoryas, 1953. *American Journal of Botany*, 40.)

mineralized while they were penetrating decaying remains of other plants. They show a

triarch stelar structure, and a distinct root cap at the growing tip.

The Cordaitales

Although vegetatively resembling some modern pinopsids, the Cordaitales were in other ways quite distinct. They must have been amongst the most impressive of the seed-bearing plants of the later Paleozoic. So far as is known, they were mostly arborescent with columnar trunks, many probably reaching heights of 30 m (98 ft) and diameters of 1 m (39 in.). Some, however, were sprawling plants with adventitious roots, providing a mangrove-like appearance. The leaves, confined to the upper branches, were spirally arranged and strap-shaped (Fig. 8.10a). In some forms they were as much as 1 m (39 in.) in length and 15 cm (6 in.) in width. There was regular parallel venation interspersed with longitudinal bands of hypodermal fibers, a structure not dissimilar to that of the leaves of the modern conifer *Araucaria araucana* (Fig. 8.13b).

In general the vascular tissue of the cordaitalean trunks consisted of a large amount of secondary xylem, typically pycnoxylic, traversed by narrow parenchymatous rays. The secondary tissues surrounded a medullated primary stele. The primary xylem tended to diminish in later forms, leaving a ring of mesarch bundles bordering an extensive pith, often broken up into lenticular diaphragms. The secondary tracheids showed several series of circular bordered pits on their radial walls, and were closely similar to those of living conifer *Araucaria*. The leaf traces, which passed outward from the primary xylem, were simple in origin and commonly consisted of two parallel strands. The roots of the Cordaitales are quite well known, since they often became per-

REPRODUCTIVE STRUCTURES

The reproductive organs of the Cordaitales (known as *Cordaianthus*) were borne on slender branches. Although male and female were separate, they possibly occurred on the same tree. Each reproductive region was basically an axis, from 10 to 30 cm (4–12 in.) in length (Fig. 8.10b), bearing two rows of bracts in a complanate distichous arrangement. The male and female shoots occurred singly in the axils of the bracts.

The individual male shoots (Fig. 8.10b) were about 1 cm (0.4 in.) long. Each consisted of a short, stout axis bearing a large number of linear-lanceolate scales, each with a single vein, in a close spiral. The lower scales were sterile, and acute or obtuse at their apices, but the upper were emarginate and terminated in several (usually six) cylindrical microsporangia. Since both sterile and fertile scales lay in one spiral, they appear to have been of similar morphological nature. The pollen grains were surrounded by air bladders (saccae) formed by the separation of the layers of the wall. The two layers remained in contact, however, in one region, possibly the site of liberation of the gametes. This thin area was opposite the small tri-radiate scar at the proximal pole of the grain. It thus appears that the Cordaitales had true pollen with distal germination.

The female shoots were of similar organization, but the fertile scales terminated in ovules instead of microsporangia. In earlier forms the fertile scales (megasporengiophores) projected conspicuously from the shoot, branched, and

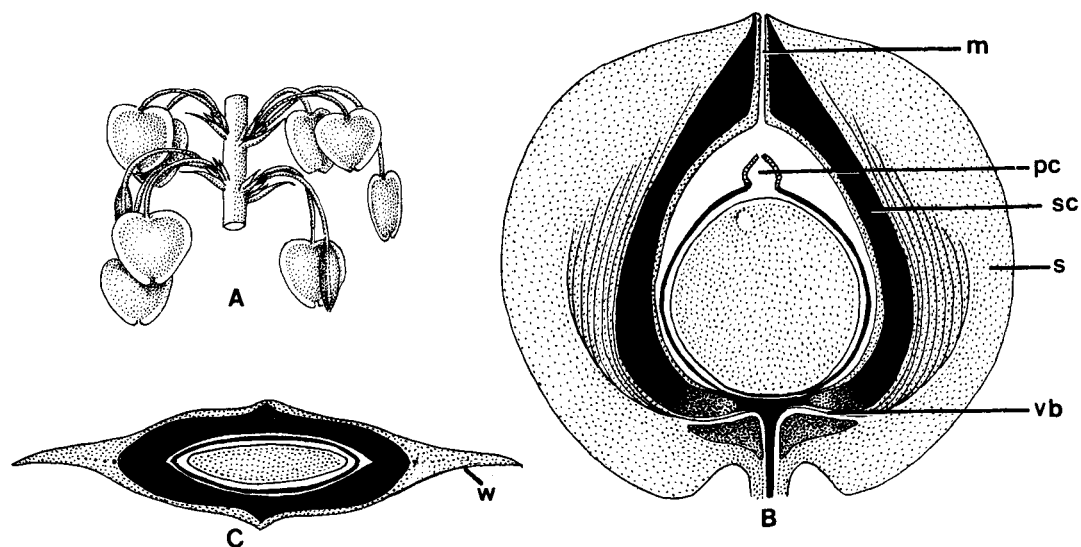

Figure 8.11 Cordaitalean seeds. (A) Axis of *Cardiocarpus* with ovules. (B and C) *Mitrospermum* in longitudinal (B) and transverse section (C), demonstrating extreme platyspermy: m, micropyle; pc, pollen chamber; sc, sclerenchymatous layer within the integument (sclerotesta); s, softer outer layer of the integument (sarcotesta), with a peripheral wing-like extension (w); vb, vascular bundle entering the ovule, the branches ascending in the sarcotesta. Both *Cardiocarpus* and *Mitrospermum* were about 15 mm (0.6 in.) long and about the same in maximum diameter. (From Stewart and Rothwell. 1993. *Paleobotany and the Evolution of Plants*, 2nd edn. Cambridge University Press, New York.)

carried more than one seed (Fig. 8.11A). In the later forms, however, the megasporangiophores were shorter and unbranched, terminating in only one seed concealed amongst the sterile scales.

The seeds of the Cordaitales were not radially symmetrical, but bilateral, the margin of the seed often being extended as a wing. Because of their characteristic flattened appearance, these seeds are termed platyspermic, and they are readily distinguishable from the predominantly radio-spermic seeds of the pteridosperms. Platyspermic seeds, similar to those seen in cordaitalean inflorescences, are frequently found detached in Carboniferous deposits and their structure is now well known (Fig. 8.11B and C). They are about 1 cm (0.4 in.) in height and only a little less in their major transverse diameter; the minor is of the order of 0.5 cm (0.2 in.). The integument was differentiated into one or more layers, at least one of

which was sclerenchymatous. The nucellus, except for the basal region, appears to have been separate from the integument. A female gametophyte, surrounded by a distinct “megaspore membrane”, developed within the nucellus, and archegonia were produced on its upper surface, the nucellus above this region becoming differentiated as a pollen chamber. Reticulate markings on the pollen grains lying in this chamber were once regarded as indicating endosporic germination of the grain, but this interpretation is now questioned. The pattern is more probably a relic of the sculpturing of the wall than of an internal cellular structure. Firm evidence for the production of a pollen tube is lacking. Gametes were possibly liberated into fluid above the archegonia. As with the pteridosperms, embryos are conspicuously absent from cordaitalean seeds. The integument of a cordaitalean seed (Fig. 8.11B and C) has the appearance of having been formed by two valves, each containing a vein, coming together and enclosing a megasporangium. This view is supported by the occasional occurrence in female shoots of what are interpreted as abortive megasporangia subtended by two unfused lobes. Each seed would thus have three components, the two outer which form the integument possibly having been derived from sterilized sporangia. It is noteworthy in this connection that the microsporangia were commonly produced in multiples of three.

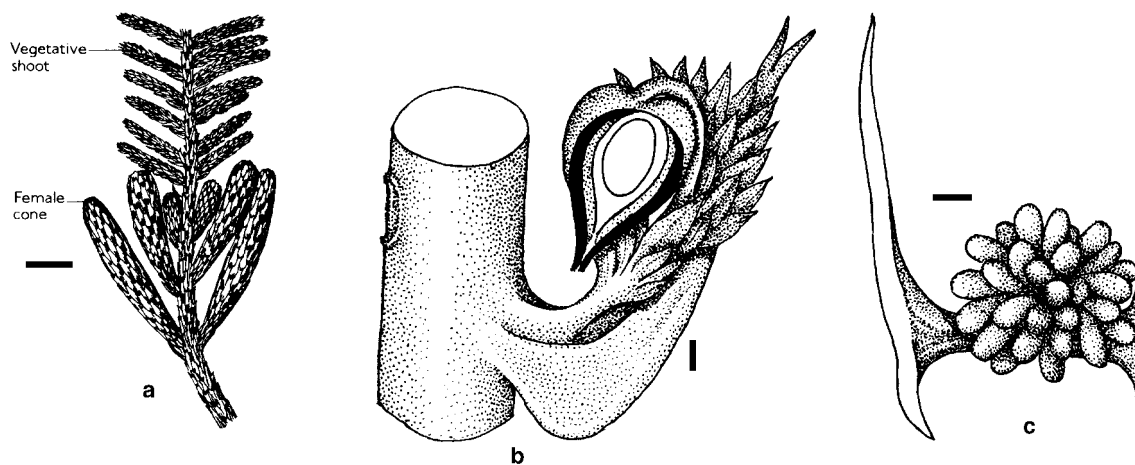

Figure 8.12 (a) Erect female cones on a branch of *Utrechtia*. Scale bar 2.5 cm. (b) Reconstruction of a cone segment of *Emporia*. The recurved ovule is sectioned to show integument, nucellus and megaspore membrane. Scale bar 1 mm. (c) Microsporangiophore of *Emporia* with pollen sacs. Scale bar 1 mm. ((a) from Florin, 1951. *Acta Horti Bergiana* 15; (b), (c) from Stewart and Rothwell, 1993. *Paleobotany and the Evolution of Plants*, 2nd edn. Cambridge University Press, New York.)

ORIGIN AND FOSSIL HISTORY

Little is known of the origin of the Cordaitales, but it possibly lay well before the Carboniferous period. Remains of substantial woody plants, the xylem of which showed araucarian pitting (p. 231), have been found as early as the Middle Devonian (p. 218). In the leaves of some of the Cordaitales of the Lower Carboniferous the nerves branched as they approached the tip, possibly indicating an origin in a fan-shaped structure. Axes bearing leaves of the kind envisaged are in fact known from the Middle Devonian of Bohemia, but the relationship of these fossils (placed in the genus *Barrandeina*) to the Cordaitales is quite unproven. Nevertheless, the impression is that the Cordaitales were derived from axial heterosporous forms in much the same way as the pteridosperms, but that in the Cordaitales the megaphyll condensed into the characteristic strap-shaped leaf and the integument of the seed evolved in a slightly different way. The earliest platyspermic seeds come from the later Devonian.

The Cordaitales probably persisted into the beginning of the Mesozoic, but then became extinct.

The Voltziales

The Voltziales are regarded as early forms of conifers, but they show a close relationship, both vegetative and reproductive, with the Cordaitales. Representative of the Upper Carboniferous Voltziales are *Utrechtia* and *Emporia* (Fig. 8.12). The Voltziales had eustelic stems with exarch primary vasculature. The wood was like that of the living *Araucaria* (p. 231). Resin ducts occurred in the pith and cortex, and in the mesophyll of the leaves. The female cone consisted of an axis about 8 cm (3 in.) long, bearing spirally or asymmetrically arranged bifid bracts. In the axil of each was a radially symmetrical, but flattened, dwarf shoot bearing small bracts and a fertile scale (Fig. 8.12b). This fertile scale bore a single ovule. The ovule was inverted, platyspermic, and adjacent to the side of the fertile scale away from the bifid bract. This fertile short shoot can reasonably be regarded as morphologically intermediate between the fertile female shoots of the Cordaitales and the ovuliferous scale of a modern conifer (Fig. 8.20). A series of fossils of late Paleozoic and early Mesozoic age, in which the vegetative and fertile parts of the female short shoot become progressively less distinct, leads ultimately to a structure extremely similar to an ovuliferous scale.

The male cones of the Voltziales (Fig. 8.12c) closely resembled those of modern conifers, and thus differed sharply from those of the Cordaitales. Although the pollen grains of the early conifers and of the Cordaitales were quite similar, in some of the earliest they may still have been at the stage of "pre-pollen" (p. 223) and

motile spermatozoids may have been produced. Nevertheless, it is also possible that the siphonogamous reproduction seen in modern conifers evolved quite early. Perhaps the advantages of siphonogamy saved the early conifers from the extinction that befell the Cordaitales.

The Pinales and Taxales (Coniferales)

The Coniferales (conifers) are the most widespread of all the groups of gymnosperms, and they form the climax vegetation at high altitudes and in the colder regions of the temperate zones, particularly the north. They are much less common in the tropics, and here they are usually confined to mountains and are often mixed with angiospermous trees. Of all the vascular plants discussed so far the conifers are the first of significant economic importance. They are almost all arborescent and the wood is used extensively as timber and as a source of pulp for paper-making and related industries.

The growth form of a conifer is frequently pyramidal, the conspicuous main axis being the principal source of the valuable timber. A few conifers of this form attain remarkable sizes and ages. Specimens of *Sequoia* (redwood), for example, in California frequently exceed 100 m (333 ft) in height, their trunks reaching diameters of several meters and showing over 2000 growth rings. *Pseudotsuga* (Douglas fir) in the forests of the Olympic Peninsula of the Pacific Northwest may attain even greater heights (but not girth). *Agathis australis*, the kauri pine of New Zealand, reaches up to 60 m (200 ft) in height, and the trunks a diameter of 7 m (20 ft). The oldest living conifers are probably specimens of *Pinus aristata* (bristlecone pine) at high altitudes on the arid White Mountains of the California-Nevada border. Modern techniques of dating show that some of these are almost 5000 years old. Another contender for longevity is a specimen of *Lagarastrobos franklinii* (Podocarpaceae), a Tasmanian endemic, claimed to be 11 000 years old.

Some conifers (such as the junipers) are bushy, and a few (confined to Australasia) are dwarf, heather-like shrubs of boggy alpine situations. Occasionally the growth form is markedly influenced by the habitat. *Pinus montana*, for example, is a pyramidal tree when growing in acid situa-

tions on lower hills, but a straggling shrub with no evident main axis (*Krummholz*) when on limestone at higher altitudes. Some conifers, although resistant to cold, cannot withstand summer drought. *Picea sitchensis*, for example, is restricted in its native Pacific Northwest of America to the fog zone. Here its growth rate reaches an impressive 100 mm (4 in.) or more in a year. Most conifers tend to be surface-rooted, and many species produce stubby rootlets in the humus layer which are associated with mycorrhizal fungi. Large stands of conifers may be linked from root to root by the mycelia of these fungi, with inevitable implications for disease transmission. *Taxodium distichum* (swamp cypress), which grows in swamps in the warmer parts of eastern North America, is outstanding amongst conifers in producing negatively gravitropic aerophores which rise above the surface of the water. These specialized roots are, however, found only in mature specimens and are rarely produced outside the native habitat.

One conifer, *Podocarpus ustus*, has been found as a parasite on a species of *Dacrydium* (also Podocarpaceae) in New Caledonia. It may regularly be a root parasite, and, if so, is unique in the gymnosperms.

SHOOTS AND STEMS

The stems of conifers grow from a group of meristematic cells. In some genera, notably *Araucaria*, the apex is organized into a distinct tunica, in which divisions are principally anticlinal, and a central corpus, where divisions are in several planes. The corpus gives rise to the pith and primary vascular tissue. In some conifers, particularly of the Pinales, a succession of shoots, produced in the axils of scale leaves, regularly undergo little extension growth. The apices of these short shoots produce a few scale leaves and then, before the apex becomes inactive, a limited number of fully developed mature leaves. In *Pinus* the number of these varies from one (Fig. 8.13a) to five, depending upon species. Extreme defoliation, following for example a massive attack by caterpillars, may result in the normally dormant apices of the short shoots resuming extension growth, so deforming the architecture of the entire shoot system. In other conifers which bear their leaves on mature stems principally in short

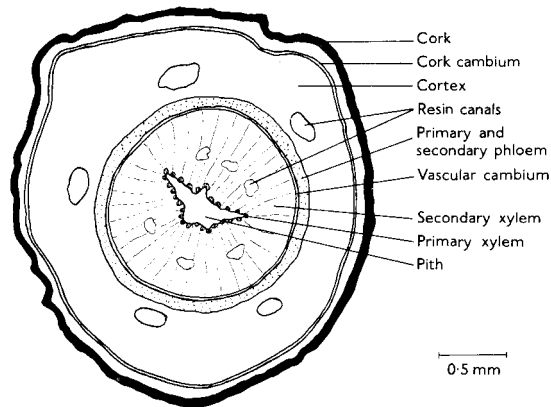
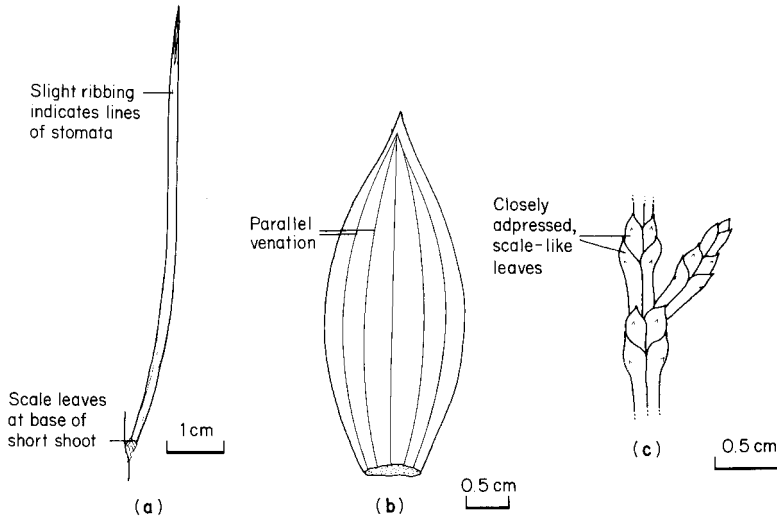
Figure 8.13 Forms of conifer leaf.(a) *Pinus monophylla*. (b) *Araucaria araucana*. (c) *Chamaecyparis obtusa*.**Figure 8.14** *Pinus sylvestris*. Transverse section of young stem with only one season's secondary vascular tissue.

shoots (e.g., *Larix*, *Cedrus*, Fig. 8.19), the number of fully formed leaves in the short shoot is less definite and does not form a specific character.

The mature stems of conifers are mostly secondary wood, the pith and primary xylem being relatively inconspicuous (Fig. 8.14). At the outside, the phloem, cortex and periderm form a comparatively narrow band. The dense secondary xylem consists of radial files of tracheids, traversed by narrow parenchymatous rays. Wood parenchyma is not conspicuous. In *Pinus* it is confined to the epithelium of the resin canals, and it is entirely lacking in *Taxus*. The tracheids are usually differentiated in distinct annual rings, those formed toward the end of a season's growth being nar-

rower than those at its beginning (Fig. 8.15). In *Pinus* the tracheids, which rarely exceed 4 mm (0.17 in.) in length, bear bordered pits, usually in a single row, on the radial walls. The central part of the pit membrane is thickened and forms the torus (Fig. 8.15). Thickenings often present along the margins of the pits are termed the "Rims of Sanio". In *Araucaria* the pits are similar, but in 3–4 rows, the pits of adjacent rows alternating (referred to as "araucarian pitting"). The tracheids of *Araucaria*, but not of *Pinus*, occasionally have small trabeculae (initially of cellulose, but subsequently lignified) extending across the lumen. These so-called "Bars of Sanio" also occur in a number of other genera.

Considerable differentiation is sometimes present in the parenchymatous rays of conifer woods. In *Pinus*, for example, the cells of the upper and lower margins in the xylem portion of the ray may form radially oriented tracheids (Fig. 8.15), and cells in a similar position in the phloem closely apply themselves to the sieve cells and become conspicuously rich in cytoplasm. The rays provide a means of transporting materials laterally in the growing stem.

The resin canals of conifers, which are schizogenous in origin and interconnected, run longitudinally in the leaves (Fig. 8.16) and xylem, and also transversely in some of the larger rays. The resin itself (a complex acidic substance containing oxidized phenols and terpenes) is synthesized in the epithelium of the canals, probably mostly in the younger tissues, but the actual site of synthesis in the cells is not yet exactly known. The resin system can be tapped by driving a gutter-shaped steel wedge into the xylem near the base of the tree (Fig. 8.17), and from some species considerable quantities of commercially valuable resin can be collected. Pine resin, for example, is the source of turpentine and colophony, both widely used in

Figure 8.15 *Pinus sylvestris*. (a)

Radial longitudinal section of secondary xylem at junction of early and late wood. (b) Tangential longitudinal section of a ray similar to that shown in (a).

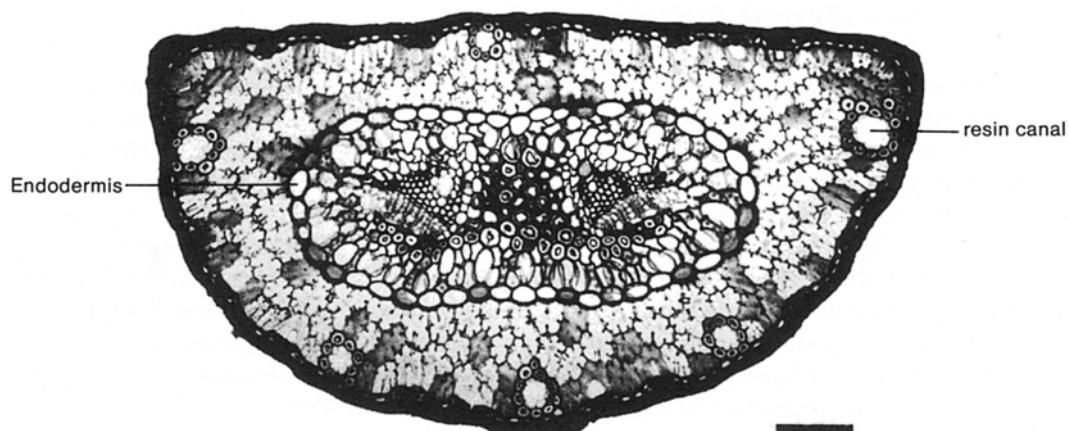
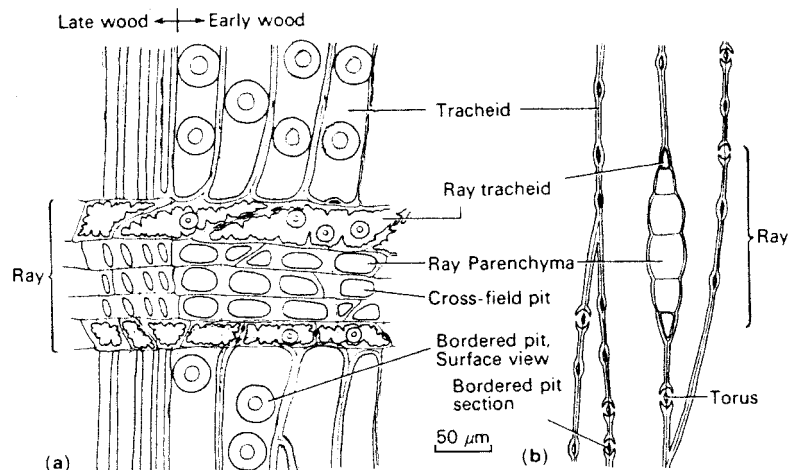

Figure 8.16 *Pinus sylvestris*. Photomicrograph of a transverse section of a leaf, the flat adaxial side uppermost, mid-way along its length. The epidermal cells are lignified and the stomata obscured, but the cells of the hypodermis are visible and adjacent to them the resin canals. Two vascular bundles, separated from the mesophyll by a common endodermis, lie at the center of the leaf. Thickened and lignified cells are found between these vascular bundles and below the phloem, but the cells elsewhere within the endodermis are largely transfusion tissue. Scale bar 0.1 mm.

the paint and varnish industry (although less so than formerly). The male bark beetle of *Pinus ponderosa* transforms a component of the resin into the sex pheromone of the species.

LEAVES

The leaves of conifers take a variety of forms (Fig. 8.13), but they are nearly always small and simple in shape ranging from needle-like structures

several centimeters in length (*Pinus*, Fig. 8.13a) to closely adpressed scales reaching only a few millimeters (as in Cupressaceae, Fig. 8.13c). *Araucaria araucana* is unusual in having broadly lanceolate leaves 5 cm (1.4 in.) or more in length (Fig. 8.13b). In the Cupressaceae the plant frequently passes through a juvenile phase in which it produces needle-like leaves. Cuttings or grafts of the juvenile phase sometimes go on producing needle-like leaves indefinitely, and these so-called *Retinospora* forms are common in gardens. The venation of conifer leaves is never reticulate. There are either a number of parallel veins (as in some species of the Araucariaceae, Fig. 8.13b) or a single median vein, often showing a double structure (as in *Pinus*, Fig. 8.16). In addition to *Pinus*, some other conifers (e.g., *Larix*, *Cedrus*, Fig. 8.19) bear their leaves wholly or principally on short shoots (p. 231). The leaves of most conifers persist for several seasons;



Figure 8.17 *Pinus pinaster* (maritime pine). The trunk of this tree (photographed in Portugal by G. E. Creber) has been tapped for resin. This species of pine is the principal source of natural resin in Europe. Scale bar 5 cm.

in only a few genera (e.g., *Larix* (larch)) are the leaves truly deciduous. In *Taxodium* and *Metasequoia* the leaves are confined to the ultimate branchlets, and the branchlets (phyllomorphs) are shed as a whole at the end of the growing season.

Many features of anatomical and physiological interest are presented by conifer leaves. The cuticles, for example, are often furnished, especially in the region of the stomata, with distinctive patterns of tubercles and ridges. Palisade and spongy mesophyll are commonly present, and in *Pinus* the walls of the mesophyll cells have ridges projecting into the cell (Fig. 8.16). A well-defined hypodermis, the cells of which may be lignified, is present in many leaves. The vascular bundles are often surrounded by transfusion tissue. Resin canals are frequent, and in some leaves (e.g., *Thuja*) a prominent gland on the back of the leaf contains of fragrant oil. The leaves of conifers at high altitudes, and of arctic regions, are remarkably resistant to frost damage. Tissue water in twigs of species of *Pinus* and *Pseudotsuga*, for example, can withstand cooling to -40°C (-40°F) without the formation

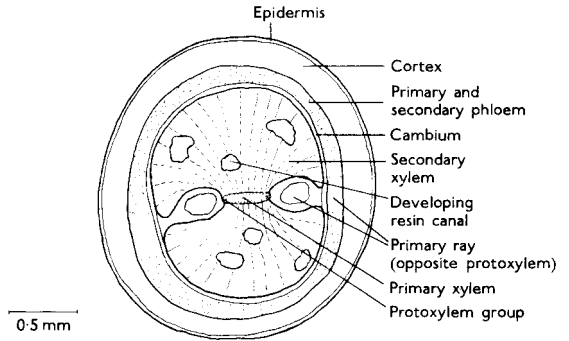

Figure 8.18 *Pinus sylvestris*. Transverse section of young root.

of ice crystals. The photosynthetic apparatus of these conifers is also able to withstand long periods of darkness without irreparable damage and, when illuminated, to carry out photosynthesis at unusually low temperatures. Additionally, the pyramidal form and the diagravitropic branches of many northern conifers are particularly suitable for trapping the low-angle light characteristic of high latitudes.

ROOTS

The roots of conifers have a simple primary structure, similar to that found in the ferns. The apical meristem is protected by a root cap, and root hairs are produced from a zone immediately behind it. Secondary vascular tissue begins to be formed at a very early stage, often before the primary tissues are fully differentiated (Fig. 8.18). Resin canals are abundant in the secondary xylem, rays and cortex.

REPRODUCTIVE STRUCTURES

As the vernacular name of the class implies, the male and female reproductive organs of the conifers are commonly borne in cones (Figs. 8.19 and 8.20). Most conifers are monoecious, but dioecious, the male and female cones being produced in different regions. In *Pinus*, for example, the female cones are produced near the apex of the tree and occupy the positions of main lateral buds, while the male cones are produced on the lower branches, usually in groups, each cone occupying the position of a short shoot. A few conifers (e.g., *Taxus* and *Juniperus communis*) are dioecious. The reproductive cones are usually compact, but

Figure 8.19 *Larix decidua* (larch).

Portion of a shoot showing the short shoots and the female cone in its second year. Note that the female cone is negatively gravitropic and that it terminates a lateral axis having a position equivalent to that of a short shoot. Scale bar 1 cm.

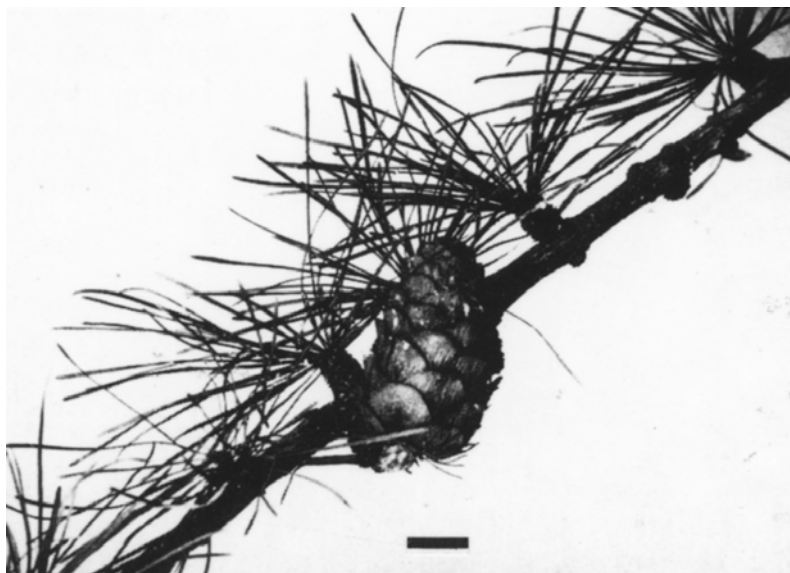
**Figure 8.20** *Pinus sylvestris*. (a)

Female cone in the early summer of its first year. (b) Single scale from cone in (a), viewed from above. (c) Longitudinal section along line *a*-*b*.

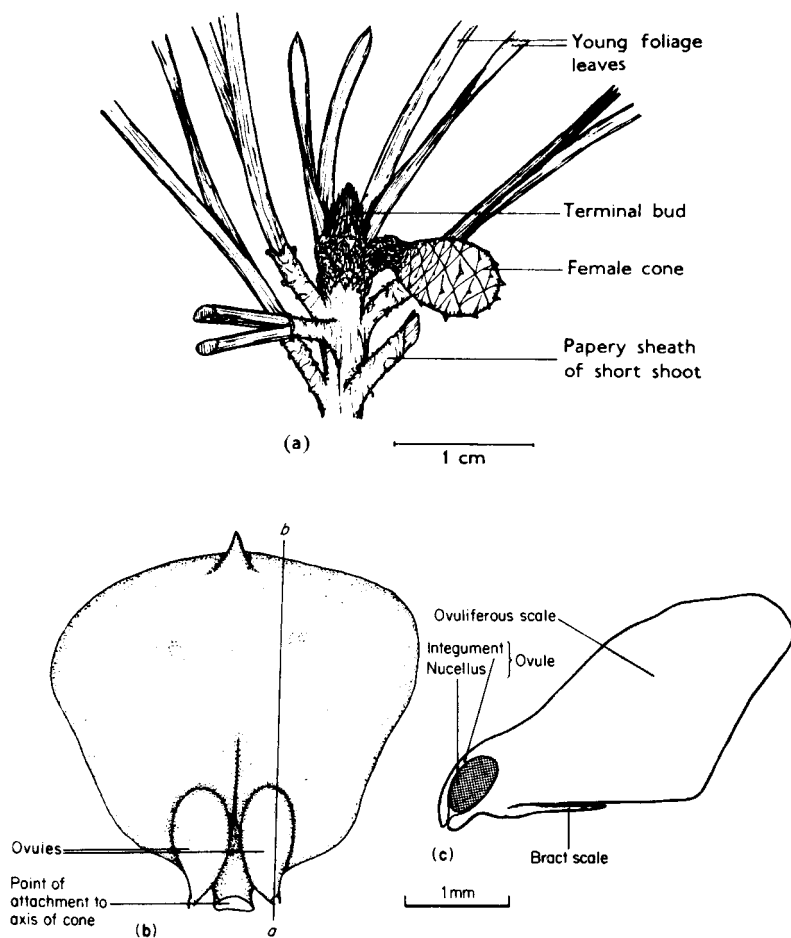

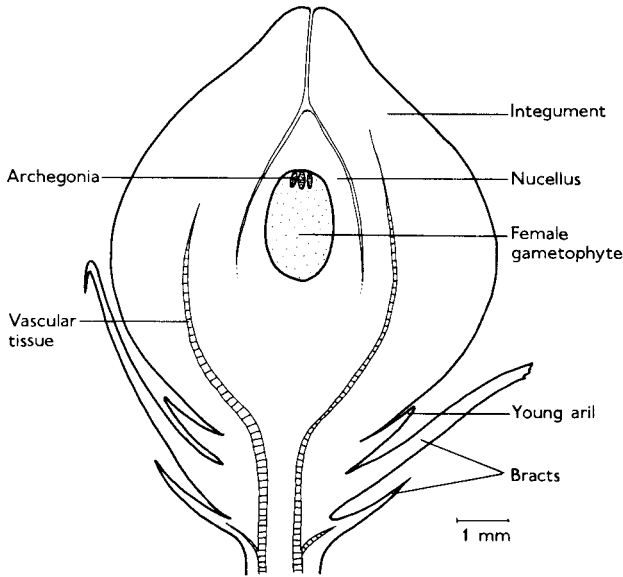

Figure 8.21 *Taxus baccata*.

Longitudinal section of young ovule. When fully mature, the nucellus secretes a sugary fluid which accumulates as a drop at the orifice of the micropyle. This serves to trap wind-borne pollen. Subsequent resorption of the drop draws the pollen down on to the surface of the nucellus, where it germinates.

before being shed (Fig. 8.23). In *Pinus*, the liberated pollen grain contains two degenerating prothallial cells, a tube cell and a generative cell (Fig. 8.26). The grains of the Taxales, Taxodiaceae and Cupressaceae, however, lack

in the Podocarpaceae the female cones are either lax or reduced, and in the Taxales the female reproductive region is not cone-like at all (Fig. 8.21). Nevertheless, the general affinities of the Taxales are clearly with the conifers.

The male cones are fairly uniform in structure, although they range widely in size. Those of *Taxus* (Fig. 8.22b) and of the Podocarpaceae and Cupressaceae are globose, hardly reaching 0.5 cm (0.2 in.) in diameter, but those of other conifers are commonly elongated (Fig. 8.22a), and in *Araucaria* they may exceed 20 cm (8 in.) in length and 3 cm (1.2 in.) in width. All, however, consist of a central axis bearing regularly arranged microsporangio-phores (Fig. 8.22a). These take the form of scales, more or less peltate in shape, a variable number of pollen sacs being attached to the head and lying parallel to the stalk. The pollen grains of many species are winged and readily identifiable. The grains of *Pinus* (Fig. 8.23), for example, have two asymmetrically placed air bladders (formed by local separation of the layers of the exine) between which the pollen tube emerges. Other grains have characteristic ornamentation; those of *Cryptomeria*, for example, possess a peculiar cuticular hook on one side. The pollen grains of some members of the Cupressaceae are “dehiscent” or “explosive”: following hydration the grains swell and the exine is shed.

Pollen grains often begin to develop internally

prothallial cells and are uninucleate when shed, whereas the mature grains of the Araucariaceae contain up to 15 prothallial cells. The pollen grains of all living conifers germinate distally, that is, away from the center of the original tetrad.

With regard to the morphology of the female reproductive regions, that of *Taxus* is considered first as it facilitates an understanding of the more complex situation in *Pinus* and other conifers. In *Taxus* the ovule terminates a short shoot bearing three pairs of decussate bracts. The ovule itself is upright and bilaterally symmetrical (Fig. 8.21). The single integument contains a sclerenchymatous layer, and two vascular bundles, diametrically opposed, ascend in the fleshy portion adjacent to the nucellus. A female gametophyte arises in the nucellus as in other gymnosperm ovules, and when mature it bears immersed archegonia in its micropylar surface. The minute short shoot terminating in the ovule is axillary to another short shoot furnished with spirally arranged scale leaves. This whole complex is itself borne in the axil of a normal foliage leaf. Both short shoots of the female reproductive system in *Taxus* are highly condensed and can be seen only by a careful dissection.

In the female cone of *Pinus* (Fig. 8.20) we are again concerned with an axis bearing spirally arranged scales in the axils of which are

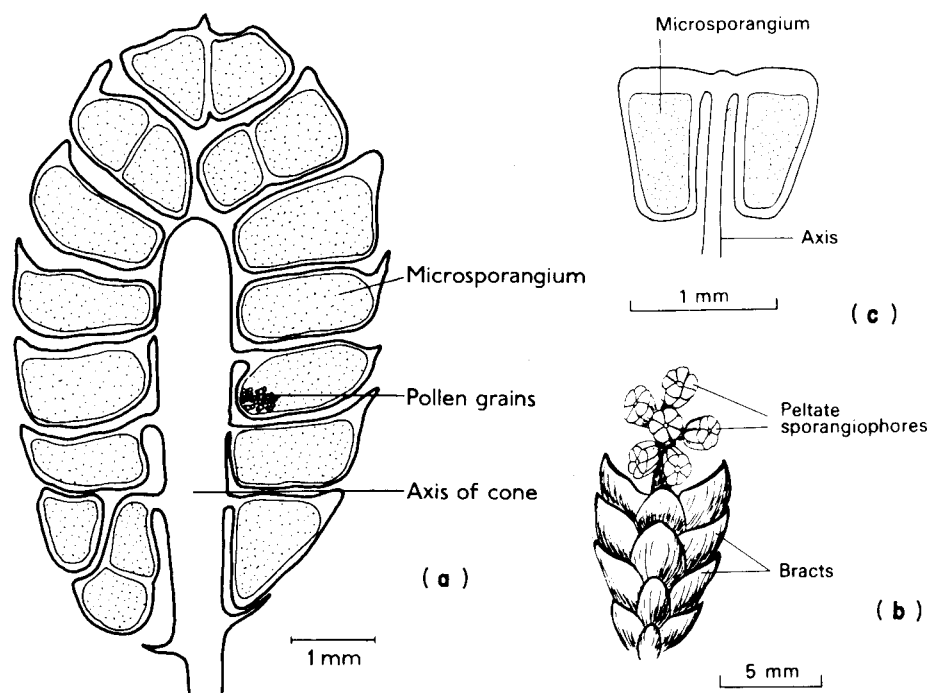

Figure 8.22 (a) *Pinus sylvestris*. Longitudinal section of male cone. Each microsporangium bears two pollen sacs. (b,c) *Taxus baccata*: (b) mature male cone, each microsporangium bearing 6–8 pollen sacs; (c) longitudinal section of microsporangium.

ovuliferous structures (Fig. 8.20b and c). In *Pinus*, however, the ovuliferous structure is also scale-like, and it is largely fused with and ultimately projects beyond the bract scale in whose axil it arises (Fig. 8.20c). This, however, is not always the situation, even in the Pinaceae. In *Abies* (fir), for example, the bract and ovuliferous scales remain separate, and in some species (e.g., *A. venusta*) the bract scale projects far beyond the ovuliferous. In the Pinaceae the ovuliferous scale bears two inverted ovules near its base (Fig. 8.20b), but in other families evolution has clearly taken a different course and the number of ovules and their orientation vary. In *Cryptomeria*, a forest tree of Japan, the ovules are upright and the ovuliferous scale develops after the ovules. In *Libocedrus*, a tree of western North America and the southern hemisphere, the ovules arise from the axis, more or less in the axil of a bract, and again the development of the ovuliferous scale is subsequent. This situation appears to be general in the family

Cupressaceae. In *Araucaria* (Fig. 8.24) the ovuliferous scale produces and ultimately entirely surrounds a single inverted ovule. A specialized ovuliferous scale of this kind, also found in some Podocarpaceae, is termed an *epimatium*. Despite these variations, ovules throughout the conifers are regularly bilaterally symmetrical and the seeds are often winged.

The morphological and anatomical evidence, now supported by the paleobotanical (p. 229), points to the ovuliferous scale being a highly modified shoot. The vascular supply to the bract scale, for example, consists of vascular bundles of which the xylem is adaxial, the orientation normal for a leaf trace. The bundles passing to the ovuliferous scale, however, are not only similar in position to those entering an axillary shoot, but the xylem of each is also abaxial, an orientation often seen at the base of a shoot trace. The female region of *Taxus* can be readily related to the cone of *Pinus* if the primary axis with its spirally arranged bracts is regarded as a cone, only one scale of which is fertile. The secondary axis with its decussate bracts and terminal ovule is then equivalent to an ovuliferous scale (Fig. 8.25).

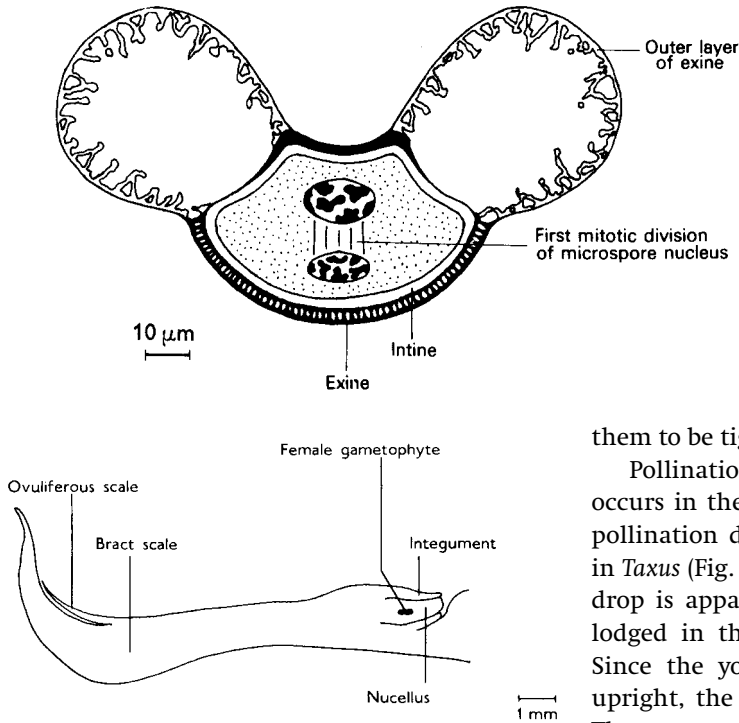

Figure 8.23 *Pinus banksiana*. Median section of pollen grain showing the first division of the microspore nucleus and the nature of the bladders.

Wind-tunnel experiments have shown that air eddies around the cone promote the accumulation of wind-borne grains between the scales. Following pollination, rapid growth of the scales causes them to be tightly packed once again.

Pollination, which in temperate climates occurs in the spring, involves in many species a pollination drop mechanism of the kind found in *Taxus* (Fig. 8.21). In *Pinus sylvestris*, however, the drop is apparently formed after the pollen has lodged in the micropylar region of the ovule. Since the young female cone is more or less upright, the ovule itself is inverted (Fig. 8.20b). The entrapped grain, assisted by its air sacs, accordingly ascends through the drop and reaches the surface of the nucellus. In *Picea orientalis* (oriental spruce) the female cones are pendent and the ovules upright. Here grains reaching the drop rapidly hydrate. The resultant swelling of the grain forces the air out of the sacs and the grain, when wholly waterlogged, sinks to the nucellus. In some conifers (e.g., *Larix*) the pollen is trapped by a stigmatic flap of the integument covered with a sticky secretion before reaching the micropylar canal. Some members of the Podocarpaceae (a family largely confined to the southern hemisphere) show "pollen scavenging": pollen alighting on wettable surfaces near the micropyle is "gathered up" by an emerging drop and drawn into the micropyle. In *Abies*, although the pollen is saccate, the ovule produces no pollination drop. It is possible that pollination here is assisted by rain drops carrying the floating pollen into the interior of the cone. In families of conifers (e.g., Cupressaceae) in which the ovules are regularly upright and produce pollination drops the pollen is non-saccate. In *Araucaria* the pollination drop mechanism is entirely absent. The pollen germinates between the scales of the female

Figure 8.24 *Araucaria araucana*. Longitudinal section of young female scale. (After Hirmer, 1936. *Bibliotheca Botanica* 28.)

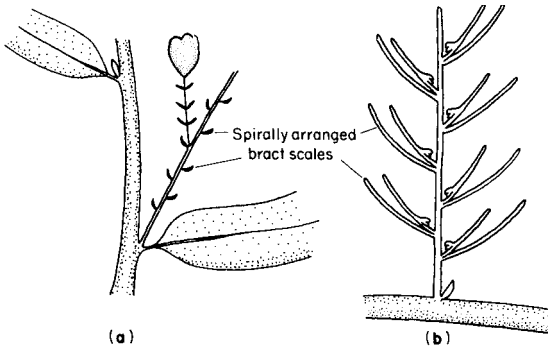

Figure 8.25 Diagrammatic representations of female reproductive regions of (a) *Taxus* and (b) *Pinales*, showing how *Taxus* can be regarded as bearing a cone only one scale of which is fertile.

POLLINATION AND FERTILIZATION

The development of the female cone is so coordinated with that of the male that at the time of release of the pollen the axis of the female cone undergoes general elongation, thus opening the scales and allowing penetration of the pollen.

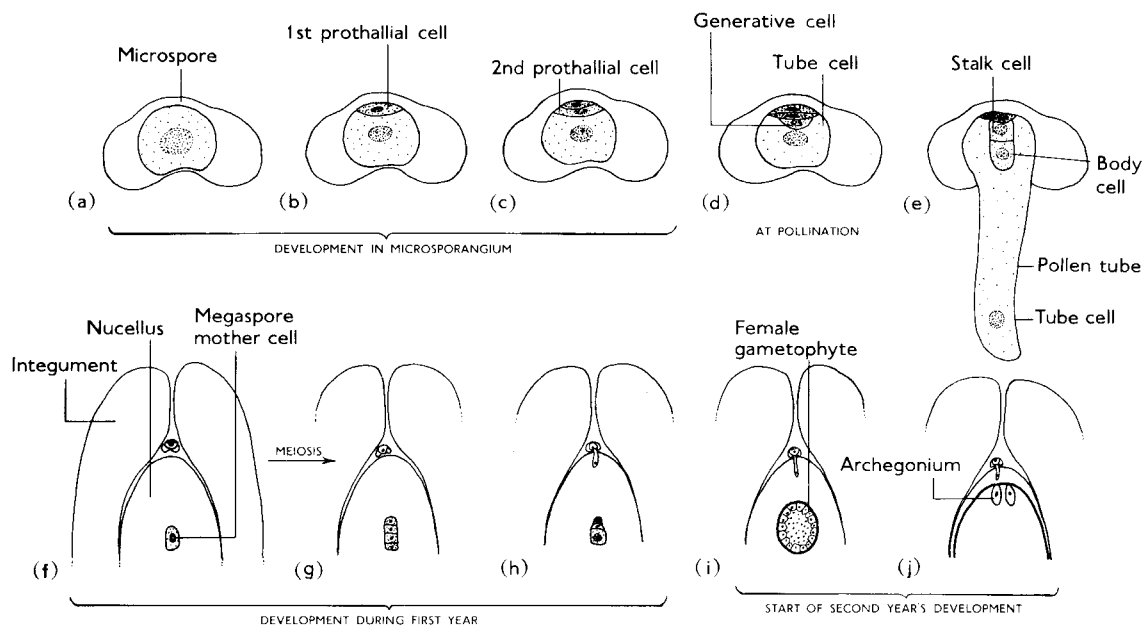

Figure 8.26 *Pinus* sp. Development of the pollen and ovule. Diagrammatic, not to scale.

cone forming a freely branching, multinucleate, mycelium-like weft, many of the branches reaching, and some penetrating, the micropyle. Pollination in *Agathis* (kauri pine) follows a similar course.

In *Pinus* the germination and development of the male gametophyte within the female cone are very slow and extend over a whole season (Fig. 8.26), coinciding with meiosis in the nucellus and the initiation of the female gametophyte. A pollen tube emerges from the grain in this first season's growth (Fig. 8.26e and h), and the generative cell divides into a sterile ("stalk") cell and a spermatogenous ("body") cell. Little further occurs in the winter, but in the following spring development is resumed. After a period of free nuclear division the female gametophyte becomes cellular (Fig. 8.26i) and 1–6 archegonia are formed in its upper surface (Fig. 8.26j), each surrounded by conspicuous jacket cells. The pollen tubes grow toward the archegonia, passage through the nucellus being facilitated by enzymes secreted by the pollen tube which promote the separation of its cells and prevent actual penetration of intact tissue. When a tube has come to within a short distance of an arche-

gonium, the spermatogenous cell, which has moved into its tip, divides into two male ("sperm") cells of unequal size. The tube eventually penetrates the archegonium and the two sperm cells are liberated into the egg cytoplasm, taking with them some male cytoplasm. The larger sperm nucleus passes into the egg nucleus, while the smaller sperm cell, the sterile cell and the tube nucleus all degenerate. Several archegonia in one ovule may be penetrated by pollen tubes, and this can result in the formation of several zygotes and subsequent polyembryony.

Reproduction in *Pinus* is representative of that of the conifers generally. Amongst the principal variations is the "dehiscent" or "explosive" pollen of the Cupressaceae (p. 235). In the Taxodiaceae the female gametophyte often produces many archegonia, up to 60 being present in *Sequoia*. Pollen tubes may discharge gametes, which in this family are similar in size, above adjacent archegonia, each then being fertilized. In *Taxus* the male gametes are naked nuclei of equal size.

In all conifers (including *Taxus*) the male gametes lack any specialized means of locomotion. The delivery of non-motile male gametes into the vicinity of the female gamete by means of a pollen tube is termed *siphonogamy*. It contrasts sharply with zooidogamy (pp. 104, 244).

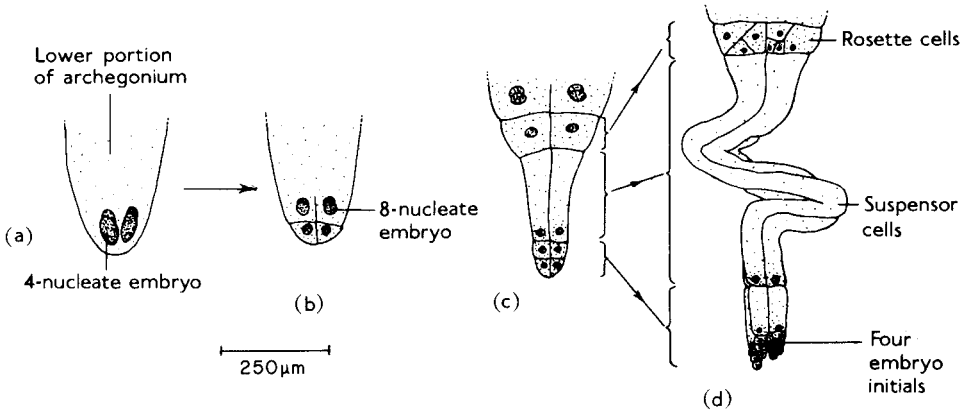

Figure 8.27 *Pinus* sp. Stages in the development of the embryo. (After Bucholz, from Foster and Gifford, 1959. *Comparative Morphology of Vascular Plants*. Freeman, San Francisco. © 1959.)

EMBRYOGENESIS

The formation of the zygote is remarkable in that in *Pinus*, and in a number of other conifers in which the male gamete retains its cytoplasm (e.g., *Larix*), the original egg cytoplasm is largely replaced by a new cytoplasm (“neocytoplasm”) formed from that introduced by the male gamete. During karyogamy the introduced cytoplasm surrounds the zygotic nucleus, and as the neocytoplasm is formed it displaces much of the original egg cytoplasm. Correlated with this unusual cytology is the discovery that in both *Pinus* and *Larix*, although the inheritance of mitochondrial DNA is maternal (despite the formation of the neocytoplasm), that of the chloroplast DNA is paternal. It has been observed in a number of conifers that during maturation of the female gamete the proplastids of the egg cell become enveloped in membranous whorls (“inclusions”) which move to the periphery of the cell. The proplastids themselves then appear to degenerate. It seems that their DNA is also depolymerized.

Germination of the zygote frequently involves free nuclear division, but in *Pinus* this is not extensive, only four nuclei being so formed (Fig. 8.27a). These move to the bottom of the archegonium and form a plate, walls then being laid down between them. These cells divide transversely, the cells of each column behaving synchronously. This leads (Fig. 8.27c and d) to the formation of a

suspensor, tetragonal in section, terminating below in four groups of embryonic initials, each capable of yielding an embryo. This so-called “cleavage polyembryony” may be further complicated by additional embryos budding off from the basal suspensor cells. Usually only one of these many potential embryos reaches maturity.

The development of the zygote in other conifers differs only in detail from that seen in *Pinus*. In *Sequoia*, for example, there is no initial free nuclear division, and in the Podocarpaceae the cells of the proembryo pass through a binucleate stage, a feature believed peculiar to this family. In other conifers polyembryony seems less common than in *Pinus*. The embryos of many conifers have several cotyledons; as many as 12 may be present in *Pinus*.

FORMATION AND LIBERATION OF THE SEEDS

The mature embryo lies in the remains of the female gametophyte and nucellus, and is surrounded by a hard seed coat formed from the integument. In some conifers (e.g., *Sequoia*, *Pinus sylvestris*) this is expanded as a conspicuous wing assisting the distribution of the seeds by wind (Fig. 8.28a). The female cone often becomes dry and woody during the formation of the seeds and sometimes does not open until a long period after the seeds are mature. In *P. sylvestris* the cone opens and releases the seeds in the second year after pollination (the whole process of reproduction thus extends over three years), but in the “closed cone” pines of the Pacific coast of North America the cones remain closed indefinitely and the seeds are

Figure 8.28 *Sequoia gigantea* (*Sequoiadendron giganteum*). (a) Seed. (b) Longitudinal section (at a–b) of well-soaked seed. (c) Young seedling.

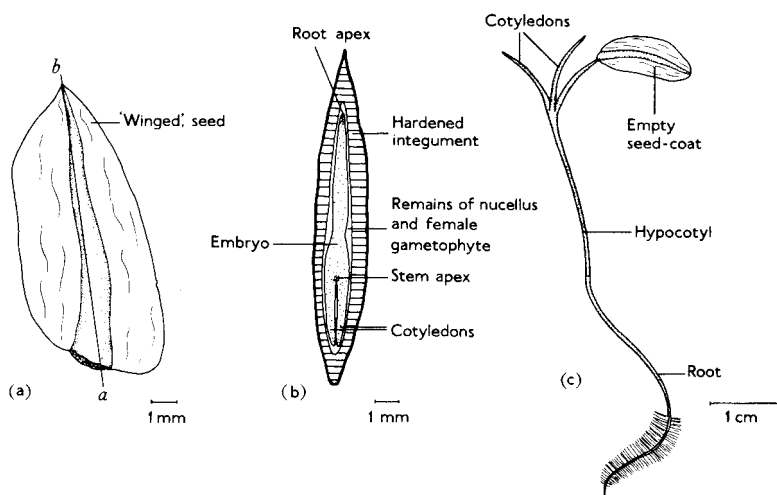
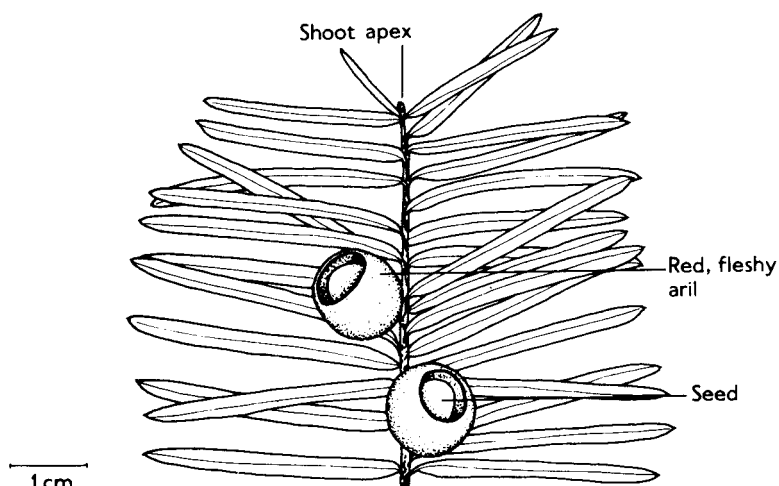

Figure 8.29 *Taxus baccata*. Shoot bearing seeds surrounded by mature arils.

released by decay of the scales or as a consequence of the singeing of the cones by a forest fire. The cones of some pines are extraordinarily large; those of the Californian *P. coulteri*, for example, may reach 40 cm (16 in.) in length and 2 kg (4.4 lb) in weight. In some Podocarpaceae and in *Juniperus* the ovuliferous scales become fleshy in fruit, the “berries” of *J. communis* being used to flavor gin. In some other podocarps and in *Taxus* the seed becomes surrounded by an aril which grows up from the base (Fig. 8.29). In *Taxus* this becomes bright red and succulent. Although the seed is poisonous, the aril is wholesome and sought after by birds, probably an aid to dispersal of the seeds. The non-winged seeds of some species of *Pinus* in both Europe and North America (“nut pines”) are edible and prized by both man and wildlife.



“berries” of *J. communis* being used to flavor gin. In some other podocarps and in *Taxus* the seed becomes surrounded by an aril which grows up from the base (Fig. 8.29). In *Taxus* this becomes bright red and succulent. Although the seed is poisonous, the aril is wholesome and sought after by birds, probably an aid to dispersal of the seeds. The non-winged seeds of some species of *Pinus* in both Europe and North America (“nut pines”) are edible and prized by both man and wildlife.

GERMINATION

In most conifers, germination is initiated by the root pole of the embryo elongating and breaking through the seed coat. The vigorous primary root soon anchors the seedling, and the elongating hypocotyl raises the remains of the seed, from

which the cotyledons are rapidly withdrawn (Fig. 8.28c). All conifer seedlings, so far as is known, become green in the dark, a remarkable property that distinguishes them from the seedlings of most angiosperms.

The seeds of *Araucaria* often germinate in the cone before it falls apart. In some species the hypocotyl swells to form a tuber, and the seedling is capable of “resting” in this condition for several months. It was this curious feature that facilitated the transmission of the first specimens of *A. araucana* from Chile to Europe in the eighteenth century.

EVOLUTION WITHIN THE CONIFERS

The fossil evidence points to the modern families of conifers having become recognizable by the

end of the Paleozoic or beginning of the Mesozoic (p. 5). The curious lax cone of many Podocarpaceae, for example, is recognizable as far back as the Lower Triassic, and the characteristic female shoot of *Taxus* seems to have evolved by the end of the same period.

The current geographical distribution of the conifers presents a number of features of evolutionary significance. Floristically, for example, the conifers of the northern hemisphere are strikingly different from those of the southern, and some families (notably the Pinaceae in the north and the Araucariaceae in the south) hardly cross the equator. Fossils of Quaternary and Tertiary age give no indication that this is a recent segregation, but they do reveal that the distribution of some families was formerly much more extensive. *Sequoia*, for example, now confined to the west coast of North America, was once widespread in the northern hemisphere. Climatic changes in polar regions have also led to contractions in the distribution of conifers. In the Tertiary period, for example, *Taxodium* swamps occurred in Spitzbergen, and in Eocene times Ellesmere Island in the Canadian Arctic supported a forest whose fossilized stumps consist of wood with a *Metasequoia*-like anatomy. *Metasequoia*, although found today only in Szechuan Province of China, had a wide distribution in North America in late Cretaceous and Miocene times. Another conifer whose distribution is currently contracting may be the recently discovered *Wollemia nobilis* (Araucariaceae), confined to a small population in a remote part of the Central Tablelands of New South Wales, Australia. It occurs mixed with angiospermous trees in warm temperate rain forest. Surprisingly, all specimens of *Wollemia* so far examined appear to be genetically uniform. A fossil pollen grain (*Dilwynites*), very similar both morphologically and ultrastructurally to that of *Wollemia*, was abundant from the Upper Cretaceous to the beginning of the Tertiary. The pollen data are consistent with a formerly widespread distribution of "Wollemi pine" in the southern hemisphere. Viewed globally, the fossil evidence clearly points to the distribution of the conifers having contracted substantially with the rise of the angiospermous forests (p. 310).

Ginkgoopsida

As with many Mesozoic gymnosperm groups, the Ginkgoopsida demonstrate what appears to be an almost random assortment of characters viewed as significant in taxonomy. In this case, a reproductive syndrome comparable with that of the cycads contrasts with a growth architecture and anatomy resembling those of the Pinopsida. Situations such as this result from the relatively common parallel development of particular characters in different groups. The problem facing paleobotanists and systematists is then to identify and distinguish those characters which have multiple origins, and those which reveal phylogeny (Fig. 8.3). In many cases confusion is compounded by the scarcity of likely primitive candidates which might indicate the antecedents of a group. The Ginkgoopsida, for example, contain a single order Ginkgoales, of which there are many fossil representatives but only one living species, *Ginkgo biloba*.

The Ginkgoales

The earliest plausible ginkgoalean fossil, *Trichopitys*, from the Lower Permian (Fig. 8.30) had spirally arranged, highly dissected leaves. Some of the leaves bore shoots in their axes which in turn supported a number of ovules, apparently with bilateral symmetry. If *Trichopitys* was indeed ginkgoalean, then the emergence of the reproductive shoot from a leaf axil suggests a relationship with the Cordaitales within the Pinopsida, a relationship supported by the pycnoxylic wood common to the two orders. However, a number of reproductive features of living *Ginkgo*, such as a haustorial pollen tube and zooidogamy, are shared with the cycads (p. 244). It may be that the Ginkgoales, like the cycads, had an independent origin amongst the pteridosperms of the Upper Carboniferous. The characteristic dichotomizing tendency in the ginkgoalean leaf may be foreshadowed in the basal dichotomy which was a regular feature of the medullosalean frond (p. 225).

Leaf fossils of Mesozoic ginkgoaleans, abundant in some localities, have been assigned to the modern genus on a basis of similarity. The genus was widespread in the northern hemisphere in the Mesozoic and early Tertiary. Jurassic species, such as *Ginkgo huttoni* and *G. digitata* (Fig. 8.31)

Figure 8.30 *Trichopitys*. (A) Part of shoot with leaves and axillary shoots with ovules. Scale bar 1 cm. (B) Detail of a fertile axillary shoot. Scale bar 1 mm. (C) Ovule. Scale bar 1 cm. (From Stewart and Rothwell, 1993. *Paleobotany and the Evolution of Plants*, 2nd edn. Cambridge University Press, New York.)

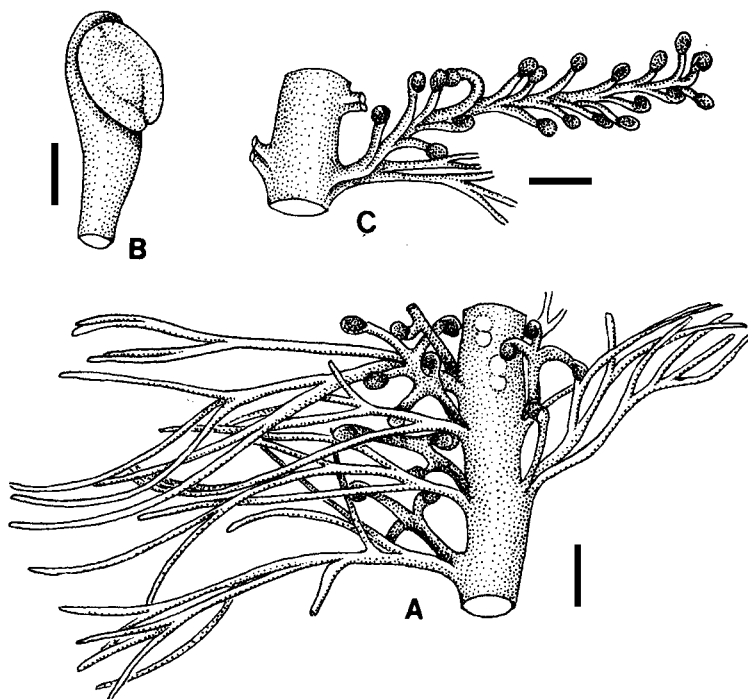

resemble extreme forms of leaf produced by *G. biloba* (particularly by juveniles). It is generally assumed that these leaves were produced by trees similar to the living species. Reproductive organs are uncommon and difficult to associate with individual leaf species.

Ginkgo biloba (maidenhair tree), the sole living representative of the order Ginkgoales, is a remarkable tree, with a striking pagoda-like arrangement of the main branches. It was unknown to the Western world until the seventeenth century. It was first discovered in Japan and subsequently in China, but always in cultivation. Suggestions that wild stands of *Ginkgo* may occur in remote parts of China, although not improbable, have never been confirmed. *Ginkgo* is now common in cultivation in all parts of the world.

Fully grown specimens of *Ginkgo* are tall, deciduous trees reaching a height of 30 m (98 ft) or more. The lateral branches bear both long and short shoots (Fig. 8.32), and leaves occur on each. Damage to a long shoot will cause one or more adjacent short shoots to behave as long shoots, indicating that their manner of growth is not irreversible, and that the maintenance of the dwarf condition probably depends upon the presence of growth-regulating substances produced by the meristem of the long shoot. Anatomically, the apices of the long and short shoots are similar and show well-defined zonation, although no distinct tunica and corpus are present. Growth takes place from a superficial group of apical initial cells. A large proportion of a mature stem consists of secondary xylem, penetrated by narrow parenchyma-

tous rays. The tracheids have bordered pits, usually in a single row, on their radial walls.

The leaves of *Ginkgo* are fan-shaped, usually with a distal notch (hence the specific name). Two vascular bundles ascend the petiole and dichotomize in the lamina, with occasional anastomoses. Short resin ducts may lie between the veins. The distal margin of the leaf is usually irregular, a feature much more marked in juvenile leaves where the distal part of the leaf may even be segmented.

REPRODUCTION

Ginkgo is dioecious, and sex determination appears to be chromosomal since the male karyotype reveals a heteromorphic pair of chromosomes. The male reproductive structures (Fig. 8.32) consist of small strobili, resembling catkins, which arise in the axils of scale leaves of the short shoot. The axis of the strobilus bears a number of microsporangioophores arranged in a loose and irregular spiral. Each microsporangioophore is slightly peltate and the sporangia, usually two, are attached beneath the head. The pollen grains, which have a characteristic furrow in the wall, contain four nuclei when shed, two of the nuclei

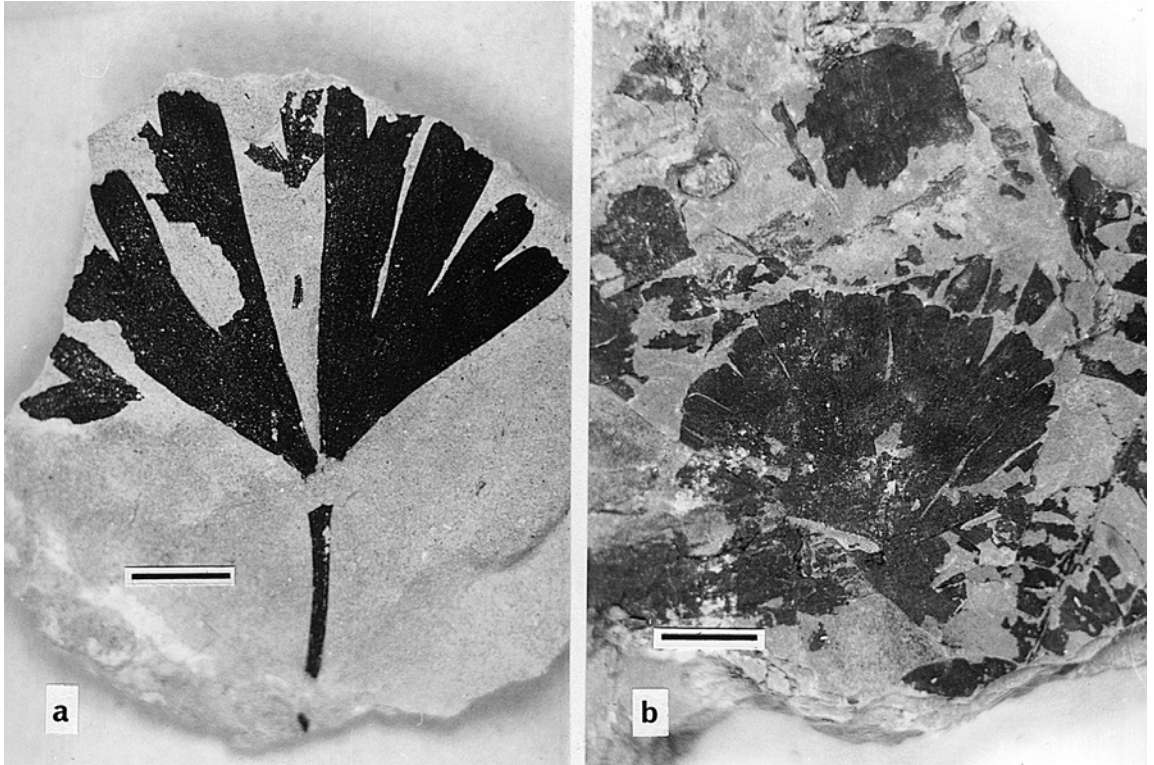

Figure 8.31 *Ginkgo huttoni* (a) bore leaves with usually three deep notches and many subsidiary shallow notches. *G. digitata* (b) had leaves with few deep notches leading to a more rounded outline. Both of Jurassic age. Scale bars 1 cm.

being associated with rudimentary prothallial cells, and the others identified as the generative and tube nuclei respectively. The first prothallial cell soon degenerates.

The ovules are usually borne in pairs, two sessile ovules being symmetrically attached at the end of a stalk-like sporangiophore. Not infrequently, however, the sporangiophore branches irregularly and bears more than two ovules. The sporangiophore itself arises, as in the male, in the axil of a scale or a leaf on a short shoot. The ovules (Fig. 8.33) are about 0.5 cm (0.2 in.) long and about as broad, and are surrounded at the base by a cushion-like swelling of the broad end of the sporangiophore. They possess a single integument into which two (sometimes three) vascular bundles, evenly spaced, ascend. The commonly bilateral symmetry is reflected in the micropyle which is slightly two-lipped at its tip. A megaspore is formed within the nucellus and this yields a

female gametophyte bounded by a conspicuous membrane. The gametophyte is unique amongst seed plants in containing chlorophyll. Sufficient light reaches the gametophyte to permit some photosynthesis, supplementing the supply of photosynthates reaching the gametophyte from the sporophyte. At maturity two archegonia arise at the micropylar end of the gametophyte. Meanwhile the nucellus above develops a pollen chamber.

Pollination is assisted by a “pollination drop” at the micropyle, and the pollen chamber, having received the pollen, then becomes closed above. The cavity of the nucellus progressively deepens, carrying the pollen with it, until it reaches the female gametophyte, the center of which is extended upward to form a so-called “tentpole” (a feature seen also in many fossil seeds). The germinating pollen forms a tube, but, as in *Cycas* (p. 251), this has a haustorial function. The tube penetrates the nucellus and there branches freely, growing through the air spaces at the interstices of the cells. The proximal part of the grain forms a sac hanging in the chamber above the archegonia. As the archegonia mature the generative cell in the

Figure 8.32 *Ginkgo biloba*. Branch of male tree, showing a long shoot and a short shoot. The short shoot is bearing microsporangiate strobili. Drawn early in the growing season before the leaves have reached mature size.

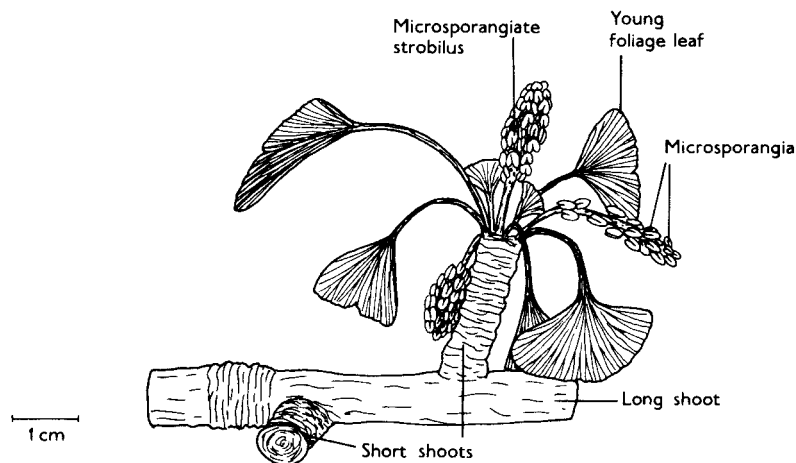
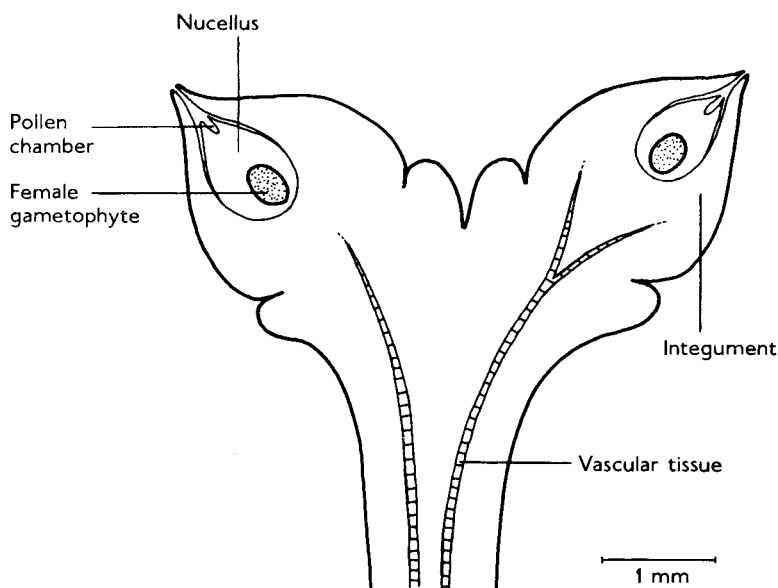

Figure 8.33 *Ginkgo biloba*. Longitudinal section of female peduncle with young ovules.



male gametophyte divides, yielding a spermatogenous and a sterile cell, the latter wrapped around the surviving prothallial cell. The spermatogenous cell develops further and produces two multiflagellate spermatozoids whose major diameters are of the order of $100\ \mu\text{m}$. These spermatozoids are released into the fluid above the archegonia and bring about fertilization. Fertilization is thus clearly *zooidogamous*.

In some locations the zygote may not be formed until after the ovule has been shed, but in others well-developed embryos have been found at this time. Development of the zygote begins by free nuclear division, leading to a proembryo containing about 256 nuclei. Walls then differentiate and a flask-shaped proembryo is formed, the lower part of which becomes the embryo proper. A clearly defined suspensor is thus absent. The mature embryo has two cotyledons. Usually only one of the paired ovules on the sporangiophore develops into a seed. In the mature seed (Fig. 8.34), which reaches a diameter of about 2 cm (0.75 in.), the outer layer of the integument becomes fleshy

and resinous, and the inner hard. The formation of the seed is completed in one season.

Diversification of radiospermic gymnosperms

Cycadopsida

The Cycadopsida in the broadest sense include all those gymnosperms with radiospermic ovules which have their origin on a foliar structure. The angiosperms can be regarded as merely specializations of this situation, but are given a higher status in view of their predominance in modern vegetation. Unlike the Pinopsida, in which the

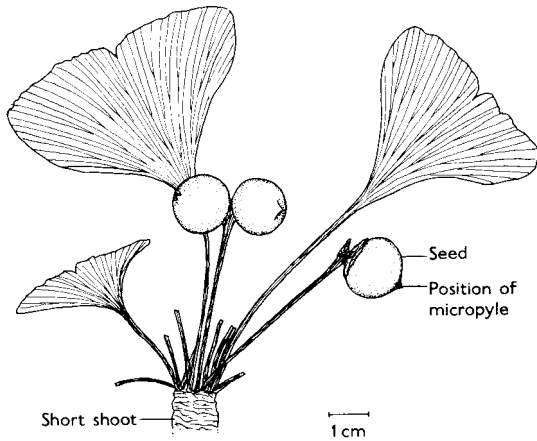

Figure 8.34 *Ginkgo biloba*. Tip of short shoot bearing ripe seeds.

early orders are extinct, the most primitive Cycadopsida, the Cycadales, are still in existence, although much diminished in numbers.

The Cycadales

The first cycads occur in the late Carboniferous, and appear to be descended directly from pteridosperms, possibly the Medullosales (Fig. 8.3). They share manoxylic wood, radiospermy, and frond-like leaves with this group. Living cycads are essentially pachycaulous in habit; extinct forms, however, appear in some instances to have been leptocaulous and may have attained faster growth rates. Early representatives such as *Bjuvia* (Fig. 8.35) from the Upper Triassic of Sweden had entire leaves, in contrast to the ubiquitous pinnate fronds of living cycads. Like those of *Cycas*, ovules were borne on the proximal part of a fertile leaf (megasporophyll), the distal sterile portion being little developed. The robust trunk presumably consisted principally of manoxylic wood, and owed much support to the leaf bases. Later cycads, such as *Beania gracilis* from the Jurassic, appear to have produced axillary female cones. These can be interpreted as determinate stems bearing highly reduced fertile leaves. Each was terminally peltate, and bore beneath two ovules, symmetrically placed (Fig. 8.36a). A more condensed version of the cone of *Beania* is found in most genera of living cycads, that of *Zamia* being closely similar. As in living *Zamia*, stomata were detected in the epidermis of the nucellus of the seed of *Beania*.

Perhaps rashly, *Beania* has been associated in a reconstruction with a relatively slender stem terminating in a crown of simple leaves of a type known as *Nilssonia* (Fig. 8.36b), but the leaves borne by at least some species of *Beania* appear to have been pinnate, like those of living cycads. There was no dichotomy in the lower part of the rachis, as in *Medullosa* (p. 225), although this feature is retained by some Caytoniales (p. 254). The cycads have some morphological resemblance to the extinct Mesozoic gymnosperms assigned to the Bennettitales and Pentoxylales, but they are now seen to be distinct and to have retained many features recognized as primitive amongst seed plants.

Although in Mesozoic times the cycads were distributed as far north as Siberia and Greenland, they are today confined to tropical and subtropical regions in both the Old and New Worlds. There are nine genera in all, the commonest being *Zamia*, *Macrozamia*, *Cycas*, *Encephalartos*, *Dioon* and *Ceratozamia*, but only *Cycas*, extending eastward from Madagascar into Polynesia, has anything approaching a wide distribution. *Encephalartos woodii* of Africa is represented only by male plants, and is probably a natural hybrid.

STEMS

The stems of the cycads are either short, stocky trunks (Fig. 8.37), often with a large portion below ground, or are much taller, some reaching heights of up to 15 m (50 ft). Below ground is a massive tap root which bears, together with normal roots, others which are negatively gravitropic and which break up at the soil surface into coralloid masses. These contain endophytic fungi and blue-green algae (Cyanophyta, p. 27).

Apart from stature, all cycads have a similar growth form. The thick stem, usually unbranched, bears an apical rosette of large pinnate leaves. The rate of growth is very slow and, although there are no recognizable annual rings in the stem, the age of any specimen can be calculated approximately from the rate of leaf production and the number of leaf bases. A specimen of *Dioon* only 2 m (6.5 ft) high was estimated in this way to be about 1000 years old. *Bowenia*, confined to North Queensland, is anomalous in possessing a tuberous rootstock bearing only one or two

Figure 8.35 *Bjuvia simplex*.

Reconstruction of plant with female cone. (After Florin, from Arnold. 1947. *An Introduction to Paleobotany*. McGraw-Hill, New York.)

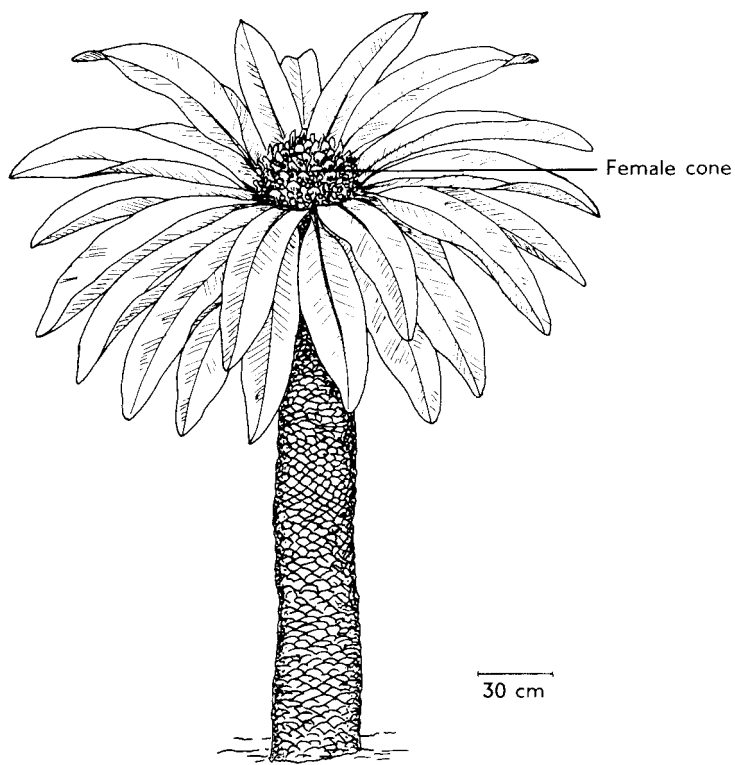
**Figure 8.36** (a) *Beania gracilis*.

Ovulate cone about 10 cm (4 in.) in length. (b) Possible reconstruction of a Jurassic plant with relatively slender axes terminating in a crown of simple leaves, bearing lateral *Beania*-like cones. Scale bar 2.5 cm. (From Stewart and Rothwell. 1993. *Paleobotany and the Evolution of Plants*, 2nd edn. Cambridge University Press, New York.)

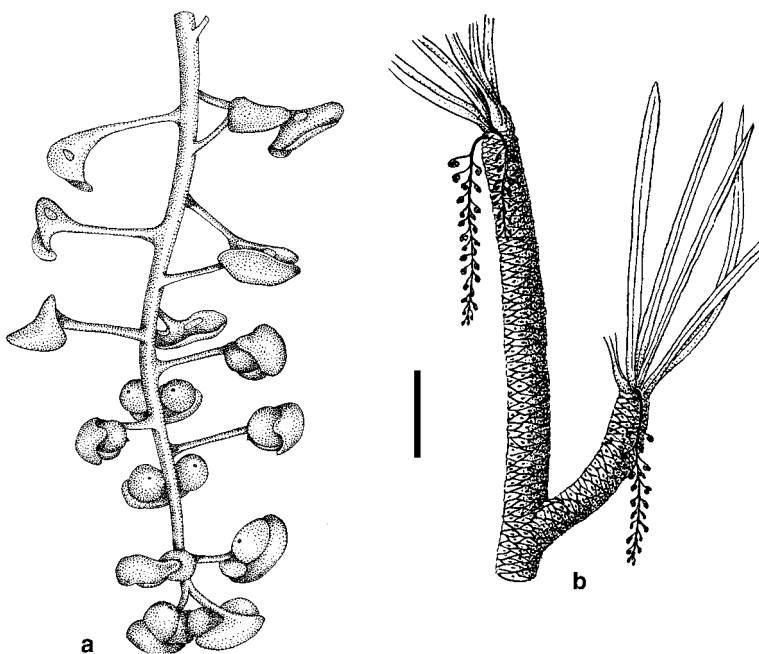

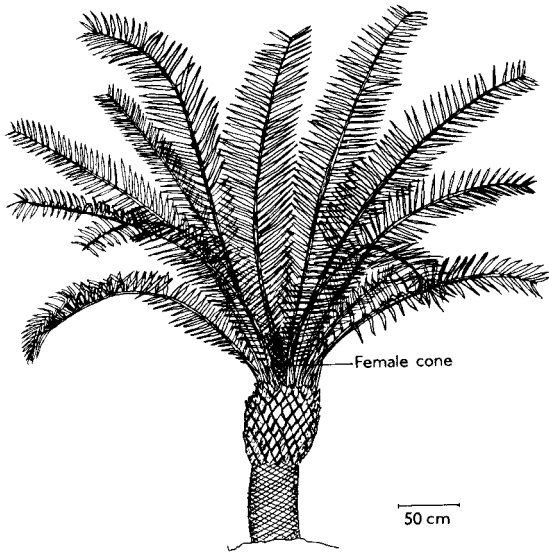

Figure 8.37 *Encephalartos hildebrandtii*. Habit of plant bearing female cone. (After Eichler, from Eichler in Engler and Prantl. 1889. *Die Natürlichen Pflanzenfamilien*, vol. II, 1. Engelmann, Leipzig.)

leaves at a time. The leaves of cycads contain a variety of metabolic products, some poisonous and others of possible therapeutic value.

The stem grows from a massive apex in which there is generalized meristematic activity, and considerable centrifugal expansion, as well as growth in length. Behind the apical initials a core of central tissue, which soon becomes distinguishable from the peripheral, differentiates into the vascular tissue and pith. The peripheral zone becomes cortex. The primary vascular tissue consists of a ring of bundles with endarch protoxylem, and these surround an extensive pith. The secondary xylem is traversed by wide parenchymatous rays and the radial walls of its tracheids are furnished with several series of circular bordered pits (except in *Zamia* and *Stangeria* where the pits are of the narrower kind characteristic of ferns). The first cambium is of limited activity, and it is followed by others which arise successively outside the vascular cylinder. These cambia are of diminishing activity, the last producing merely a few concentric bundles lying out in the cortex. The stele is thus highly parenchymatous, and the main mechanical support of the stem comes from its armor of sclerenchymatous leaf

bases. The cycads generally thus provide typical examples of manoxylic stems. Mucilage canals, tannin cells, and cells containing crystals of calcium oxalate occur in the pith and cortex of mature stems.

Apart from the conspicuous foliage leaves (or fronds), the stem also bears scale leaves, sequences of each kind of leaf following a common phyllotactic arrangement. The scale leaves cover the apex and the upper part of the stem (Fig. 8.38), often disintegrating to form a fibrous sheath below. The foliage leaves in some species reach 1 m (39 in.) or more in length. In *Cycas* and in most other genera the vernation of the young leaves is circinate (as in polypodioid ferns), but in a few the vernation is similar to that seen in the fern *Botrychium* (p. 180). In all cycads the leaves are pinnately branched, but are twice pinnate only in *Bowenia*. In *Cycas micholitzii*, a distinctive species from southeast China and north Vietnam, the primary pinnae are pedately branched into a small number of pinnules. The vascular supply to the leaf is seen in sections of the rachis as a horse-shoe-shaped trace of individual bundles. The trace has a complex origin in the stem. Some strands arise opposite the insertion of the leaf and girdle the stem obliquely upward into the leaf base. In an individual bundle of the trace much of the metaxylem is adaxial to the protoxylem, but characteristically a few tracheids, often separated by parenchyma, lie on the abaxial side adjacent to the phloem ("centrifugal xylem").

The venation of the pinnae is various, but any branching is dichotomous and open. In section small patches of transfusion tissue (anatomically intermediate between parenchyma and tracheids) are often present on each side of the xylem. In *Cycas*, where each pinna has only a midrib, a sheet of similar cells extends from the midrib to the margin ("accessory transfusion tissue").

The pinnae have a leathery texture. A conspicuous cuticle is usually present, and an epidermis (often accompanied by a hypodermis), palisade and mesophyll are well differentiated. The cell walls of the lower epidermis are straight or slightly sinuose, and the stomata, although usually sunken, are surrounded by a simple ring of subsidiary cells (*haplocheilic* stomata; Fig. 8.44b). These epidermal features, which remain clearly

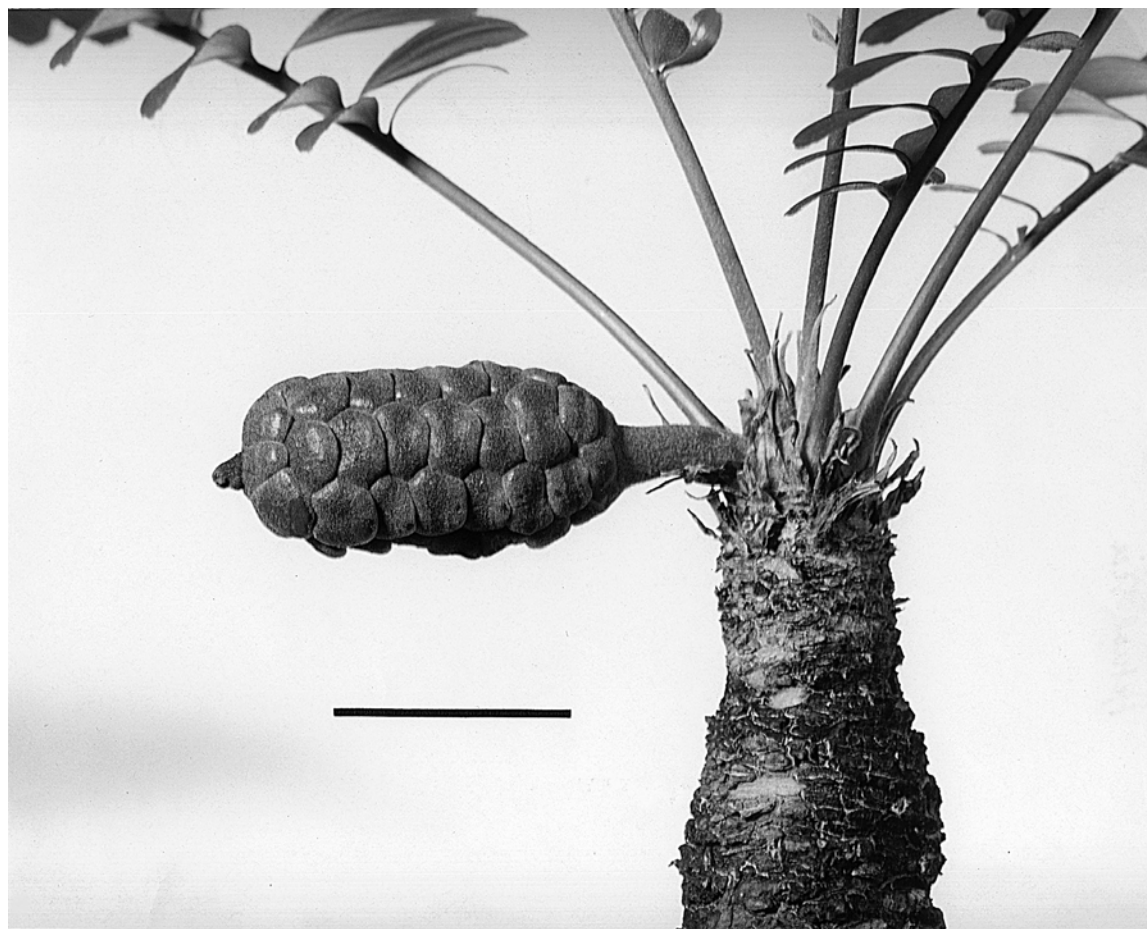

Figure 8.38 *Zamia* sp. Young plant with female cone. Although produced terminally, the female cone becomes pushed to one side by the sympodial growth and appears to be lateral. Scale bar 5 cm. (Photograph by Frank White.)

evident in fossil material, are of great value in distinguishing extinct Mesozoic forms from superficially similar contemporary plants (see Fig. 8.44).

REPRODUCTIVE STRUCTURES

The mega- and microsporangioophores of the cycads are aggregated into separate strobili borne on different plants. The female cone either terminates the main axis (in which case subsequent growth is sympodial, Fig. 8.38) or it is lateral, according to the genus. The situation in *Cycas* is exceptional for here the main axis, having given rise to a sequence of megasporangiophores, continues to be active and reverts to the production of normal vegetative leaves.

The female cones vary in compactness and in the number of ovules borne on each megasporangiophore. At one extreme stands *Cycas*, in which the female cone consists of a loose aggregate of megasporangiophores, the distal, sterile portions of which are more extensive than in any other cycad. Several pairs of ovules are attached in the proximal region (Fig. 8.39b), the micropyles of the ovules being directed obliquely outward. At the other extreme are *Zamia* and *Encephalartos*, in which small, peltate sporangiophores (Figs. 8.38 and 8.39a) are tightly packed in a distinct ovoid cone. Each sporangiophore bears two ovules, the micropyles of which are directed toward the center of the cone. Both the cones and ovules in the cycads generally are of extraordinary size. In *Encephalartos* female cones have been recorded weighing as much as 45kg (90 lb), and in *Macrozamia* the ovules reach a length of 6 cm (2.4 in.). The whole of the female reproductive system

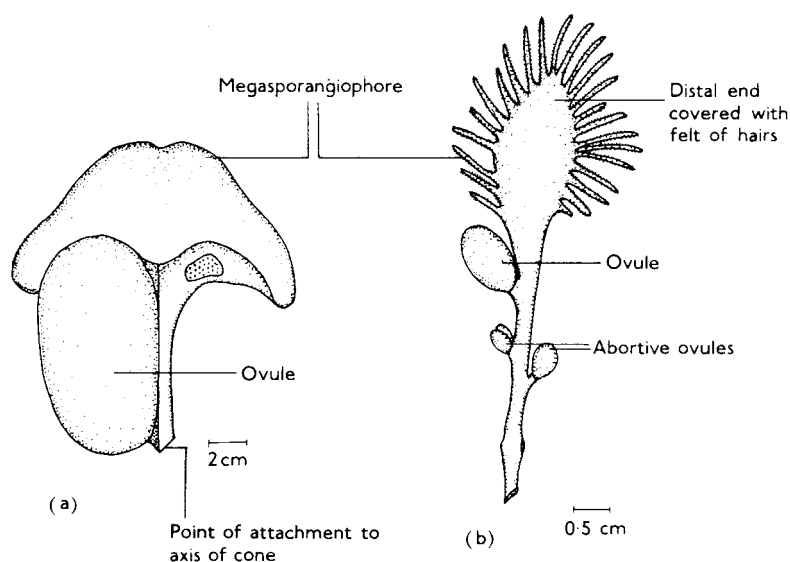

Figure 8.39 (a) *Encephalartos hildebrandtii*, megasporangiophore. (b) *Cycas revoluta*, megasporangiophore.

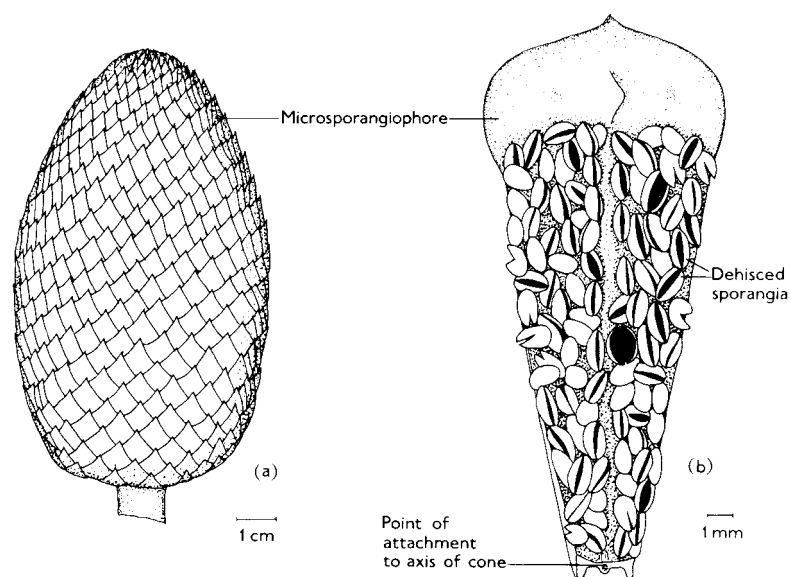

Figure 8.40 *Cycas* sp. (a) Male cone. (b) Microsporangia, the scale viewed from below.

erable variation in size. In some species of *Encephalartos* the male cones reach a length of 50 cm (19 in.), but in *Zamia* only 5 cm (2 in.). The microsporangiophores are in the form of scales, closely adpressed during growth and when mature covered on their lower surfaces with several hundred microsporangia (Fig. 8.40b). The sporangia, about 1 mm (0.04 in.) in length and structurally resembling those of the

is thus on a much larger scale than in any other living plants.

The male cones of the cycads (Fig. 8.40a) are also either terminal or lateral. Where terminal, subsequent growth is always (including that of *Cycas*) sympodial. Where lateral, growth is monopodial and the cones may be present in considerable numbers. In *Macrozamia*, for example, 20–40 cones may be produced in rapid sequence around the lower part of the apex. There is much more uniformity in the structure of the male cones than in that of the female, although again consid-

fern *Angiopteris*, are grouped in sori, each consisting of 3–4 sporangia. Their origin is eusporangiate and their formation almost simultaneous. Each sporangium produces some hundreds of spores. In *Encephalartos*, temperatures some 15°C above the ambient have been recorded in male cones at the time of meiosis, a consequence of the intense respiratory activity throughout the cone at this stage of development. The microspores of the cycads as shed (and partially dehydrated) are characteristically boat-shaped as a consequence of a broad germination furrow (*colpus*) in the distal

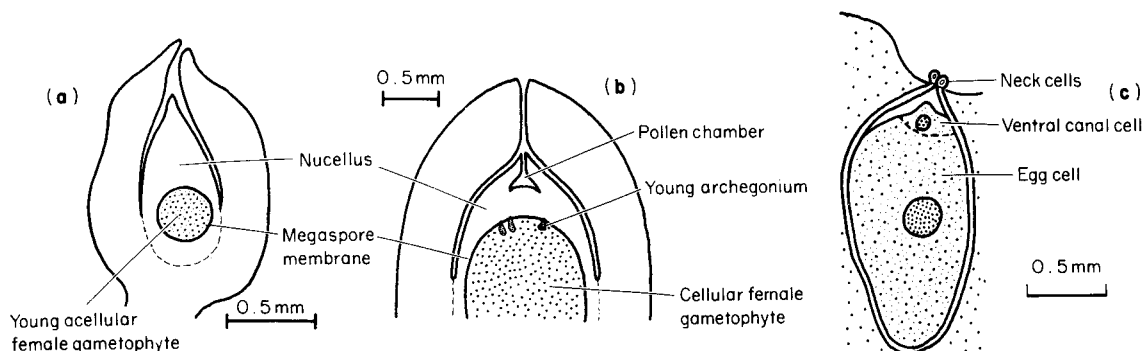

Figure 8.41 Female reproductive system of cycads. (a) Longitudinal section of young ovule. (b) Completion of development of female gametophyte. (c) Archegonium containing newly formed egg. (After McLuckie and McKee. 1958. *Australian and New Zealand Botany*. Horwitz, Sydney.)

face. Since there is a single germination site, the grains are termed *monocolpate*. The exine on the proximal face shows only an indistinct tetrad scar. Germination of the microspores begins in the sporangium, and each spore when shed already contains three cells, namely a single prothallial cell, a generative cell and a tube nucleus (Fig. 8.42a).

DEVELOPMENT OF THE GAMETOPHYTES AND FERTILIZATION

The ovules of the cycads are distinctly radio-spermic (although platyspermic forms may have occurred in the Paleozoic), and the integument is differentiated into sclerenchymatous and fleshy layers. In *Zamia* stomata occur in the nucellar epidermis, a peculiar feature which may be present in other cycads. In the immature ovule the megaspore mother cell, which is deeply embedded in the nucellus, undergoes meiosis and gives rise to four megaspores in a linear or T-shaped tetrad. The three outer megaspores degenerate, but the inner (chalazal) megaspore remains viable and develops a layered wall of surprising complexity. It germinates *in situ* and begins to form the female gametophyte, the initial development of which consists of a sequence of free nuclear divisions (Fig. 8.41a). The gametophyte enlarges with the expanding ovule and eventually a vacuole forms at its center. Wall formation then begins at the periphery of the gametophyte and continues centripetally. The archegonia (Fig. 8.41b) appear at the micropylar end of the gametophyte where the

cells are comparatively small. A distinct and thickened boundary, known as a “megaspore membrane”, persists between the haploid gametophyte and the diploid nucellus.

Although at first sight unfamiliar, the archegonia of the cycads can be seen from their development to be quite similar to those of the lower archegoniate plants. A single initial cell divides into an outer primary neck cell (which subsequently gives rise to one tier of neck cells) and an inner central cell. The latter rapidly expands, and then divides to form the egg and a small superficial ventral canal cell (Fig. 8.41c), which degenerates as the egg becomes ready for fertilization. Maturation of the egg involves considerable cytological activity. The nucleus enlarges and becomes weakly staining, and in *Zamia* small bodies, which appear in the light microscope as refractive droplets, are seen to stream away from its surface into the cytoplasm. This phenomenon, not yet investigated in depth, possibly resembles the events in the maturing egg of the fern *Pteridium* (p. 205). The cycads possess the largest egg cells known amongst land plants. The diameter may reach or exceed 3 mm (0.13 in.) or more, and even that of the nucleus may be as much as 0.5 mm (0.02 in.).

Pollination, which occurs during the closing stages of the growth of the female gametophyte, is brought about by the microspores, which are distributed by wind, or in some species possibly by insects. The existence of *Microcycas calocoma*, a Cuban species, for example, appears to be endangered because of the increasing rarity of its pollinator. The pollen grains are trapped in a sugary “pollination drop” at the orifice of the micropyle. This fluid, probably secreted by the cells at the tip of the nucellus, is subsequently withdrawn, carry-

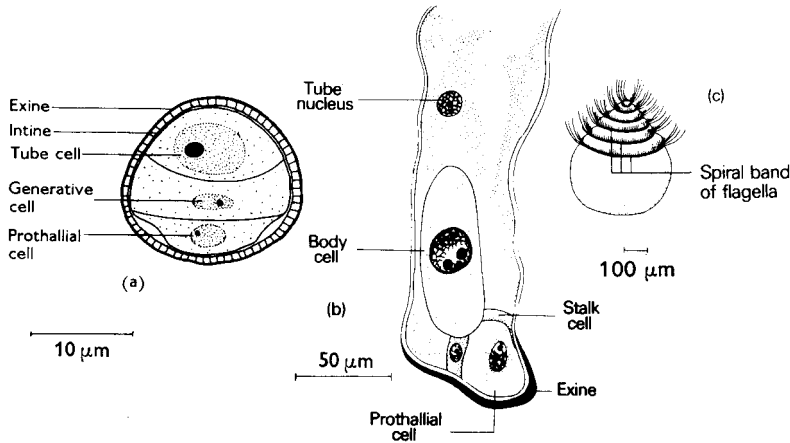

Figure 8.42 *Cycas* sp.
Development of the male gametophyte. (a) Vertical section of microspore at liberation. (b) Longitudinal section of pollen tube. (c) Spermatozoid. ((a), (b) after Swamy, 1948. *American Journal of Botany* 35; (c) modified after Swamy, 1948. *American Journal of Botany* 35.)

may reach 300 mm in diameter. Normally only two spermatozoids are produced, but in *Microcycas* the sterile cell continues to divide giving rise

ing the microspores with it. These now become lodged in a shallow pollen chamber formed by autolysis at the tip of the nucellus (Fig. 8.40b). Here each grain puts out a tube from the distal part of the grain (i.e., on the side away from the center of the original tetrad) laterally into the nucellus. This tube, which is of limited growth (unlike the freely branching pollen tube of *Ginkgo*, p. 243), has a purely haustorial function, and only the tube nucleus enters it. In *Zamia* small outgrowths of pollen tubes may invade and ultimately kill individual nucellar cells.

In the presence of the pollen, and possibly accelerated by enzymes secreted by it, the upper part of the nucellus continues to break down, until all that remains above the mature archegonia is a small pool of fluid. The development of the male gametophyte meanwhile continues. The generative cell, the only cell to show further activity, divides, giving rise to a spermatogenous (body) cell and a sterile (stalk) cell which surrounds the prothallial cell (Fig. 8.42b). The proximal part of the male gametophyte now extends and bends over the archegonia. The male gametophyte of the cycads thus shows bidirectional growth; initially distally into the nucellus, and later proximally down toward the female gametophyte.

At the final stage of development the nucleus of the body cell divides. Each daughter nucleus, together with some cytoplasm, then differentiates into a coiled, multiflagellate spermatozoid (Fig. 8.42c). The spermatozoids are constructed on the same principles as those of the lower archegoniates, but are much larger and in some cycads

to 10 or more spermatogenous cells, each of which yields a spermatozoid. Only the first-formed appear to be fully functional. This may represent the persistence of a primitive situation.

The spermatozoids are finally released from the proximal part of the tube, close to the ruptured exine, directly into the fluid above the archegonia. One or more eggs become fertilized. The penetrating spermatozoid sheds its cytoplasm (including the flagella) in the cytoplasm of the egg, and its nucleus enters and disperses in the large female nucleus. As in *Ginkgo*, fertilization is zooidogamous.

This account of the development of the male gametophyte and fertilization is based principally on events in *Macrozamia*, *Dioon*, *Zamia* and *Cycas*. The distal germination of the microspores in these genera coupled with the proximal release of the gametes suggest a position intermediate between the pre-pollen of most of the pteridosperms and the pollen of the conifers and angiosperms. Many features of sexual reproduction in the cycads, however, need confirmation and re-investigation by modern techniques. In *Encephalartos*, it has been observed that, in archegonia receiving a single spermatozoid, the egg nucleus often fragments on penetration. This may indicate the existence of a mechanism of sperm selection in this genus, certain gametic genomes being incompatible.

EMBRYOGENESIS

Although the development of the male and female gametophytes and the interval between

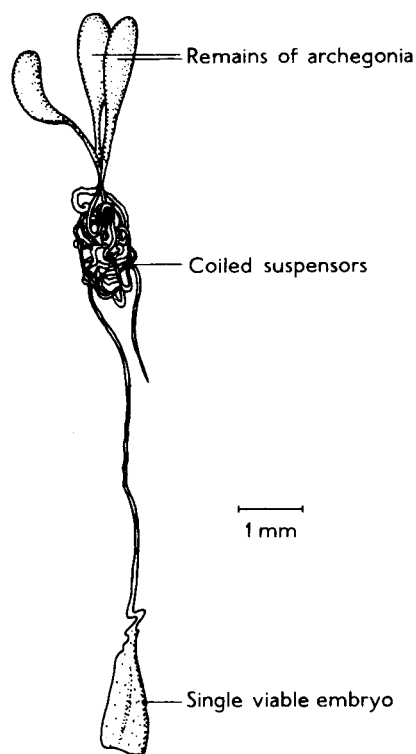

Figure 8.43 *Cycas* sp. Embryo and suspensor. (After Swamy, 1948. *American Journal of Botany* 35.)

pollination and fertilization is prolonged and may extend over months, the formation of the proembryo follows immediately after fertilization. After a period of free nuclear division, in which as many as 256 (2^8) or even more nuclei may be formed, the proembryo becomes partly or wholly cellular. Further growth takes place at the chalazal end, and the embryogeny is evidently endoscopic. At the extreme base of the proembryo is a group of small meristematic cells which develop into the embryo proper, in some species protected on the outside by a layer of cap cells which later degenerate. Above the embryonic cells are a number of elongating cells which form a conspicuous suspensor. The mature suspensor may reach several centimeters in length, but the resistance it meets in driving the young embryo into the nutritive tissue of the female gametophyte causes it to be highly twisted and coiled (Fig. 8.43).

The embryo grows and differentiates at the expense of the food reserves, including starch and

fats, prominent in the cells of the female gametophyte ("pseudo-endosperm"). The mature embryo has two or several cotyledons (depending upon the species), directed away from the micropyle and enclosing the stem apex (plumule). Although a short axis is present below the cotyledons (hypocotyl), a root is still lacking at this stage. The whole is surrounded by the exhausted remains of the female gametophyte and nucellus, and externally by the integument. Germination occurs as soon as conditions are favorable and the seed has imbibed sufficient water. The hypocotyl pushes its way through the micropylar end of the seed and then begins to develop a strong tap root which persists throughout the life of the plant. The cotyledons remain partially enclosed in the seed, but the plumule emerges and gives rise to scale and mature leaves, the first of which have only a few pinnae.

POSSIBLE ORIGIN OF THE CYCADS

As described earlier (p. 245), the first cycads are found in the late Paleozoic. In their radiospermic seeds and in the complexity of their stelar structure the cycads so closely resemble the later pteridosperms that it seems beyond doubt that they had their origin in some common stock. If so, both leaves and sporangiophores would have been derived from lateral branch systems. If we compare the megasporangiophore of *Cycas revoluta*, with its pinnate distal portion, with that of *Zamia*, where the sterile distal portion is lacking, we may see the process by which an ovuliferous megaphyll lost its sterile region and became wholly reproductive. This specialization seems to have been accomplished earlier in the male inflorescences, since in all cycads, even those of Paleozoic age, the microsporangiophores have little sterile tissue.

The Bennettitales

The Bennettitales are wholly fossil, their record extending from the Triassic to the Cretaceous periods. The frequency of their remains is such that they were probably a more conspicuous element of the Mesozoic flora than were the Cycadales. In habit there was a general resemblance to the cycads. Some Bennettitales were upright, sparingly branched plants, while others

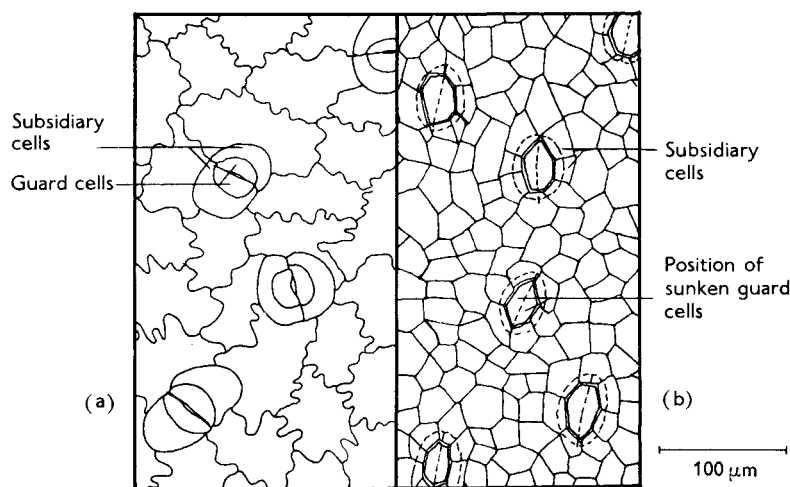

Figure 8.44 Fossil cuticles of (a) the bennettitalean type, and (b) the cycadalean type. (From a preparation by W. G. Chaloner.)

female (Fig. 8.45a). In *Cycadeoidea* the ovules are often well preserved, and this genus provides the oldest known example of megaspores produced in a linear tetrad. The seeds were similar in structure and symmetry to those of cycads and pteridosperms, although the existence of a second integument

were squat, bearing a crown of leaves near the soil surface.

The leaves of the Bennettitales were entire or pinnate, and very similar to those of the cycads. They were not in fact easily distinguishable from these until it was discovered that the epidermal features were quite different (Fig. 8.44). In the Bennettitales the walls of the epidermal cells were highly sinuose, and the guard cells and subsidiary cells appear to have had their origin from the same mother cell, giving rise to so-called *syn-detocheilic* stomata of characteristic form.

The stem structure, so far as it is known, was similar to that of the cycads, except that girdling leaf traces appear to have been absent. Secretory canals were, however, occasionally present, a feature shared with cycads and some pteridosperms.

REPRODUCTION

The cones of the Bennettitales appear to have been bisexual in most cases, the male portion being below the female. Each consisted of an axis bearing upright (outward-facing) ovules interspersed with sterile scales. The ovules were surrounded by an elongated integument similar to that found in the Gnetopsida (p. 259). The subtending whorl of microsporangiophores produced either microsporangia (Fig. 8.45) or complex synangia. The pollen grains were monocolpate, similar to those of the cycads and later pteridosperms. In most forms the inflorescence was bisexual, the male portion being below the

female (Fig. 8.45a). In *Cycadeoidea* the ovules are often well preserved, and this genus provides the oldest known example of megaspores produced in a linear tetrad. The seeds were similar in structure and symmetry to those of cycads and pteridosperms, although the existence of a second integument

has been suspected in some forms. Unlike the pteridosperms, embryos are sometimes well preserved. A massive hypocotyl was directed toward the micropyle, resembling the situation in the cycads.

The general anatomical and reproductive features of the Bennettitales indicate that they also had their origin in some pteridospermous stock, and in some respects the resemblance is closer than with the cycads. The microsporangiophores (Fig. 8.45b), for example, can be readily envisaged as derived from condensed microsporangiate pteridosperm fronds. The derivation of the bisexual cones can be envisaged as following from the condensation of an originally bisexual frond, or from an axillary shoot with upper female and lower male branches. However derived, the bisexual cones, often with subtending bracts, were strongly suggestive of flowers.

The fossil record indicates that the Bennettitales evolved in parallel with the cycads. There is no obvious explanation of why they should have become extinct whereas the Cycadales survived. It is noteworthy, however, that the microsporangiophores of the bennettitalean cone commonly ascended close to the ovules, and self-pollination may have been the rule. This would have limited genetic recombination and consequent adaptability.

The Caytoniales

The Caytoniales, Triassic and Jurassic in age (and possibly extending into the Lower Cretaceous), are

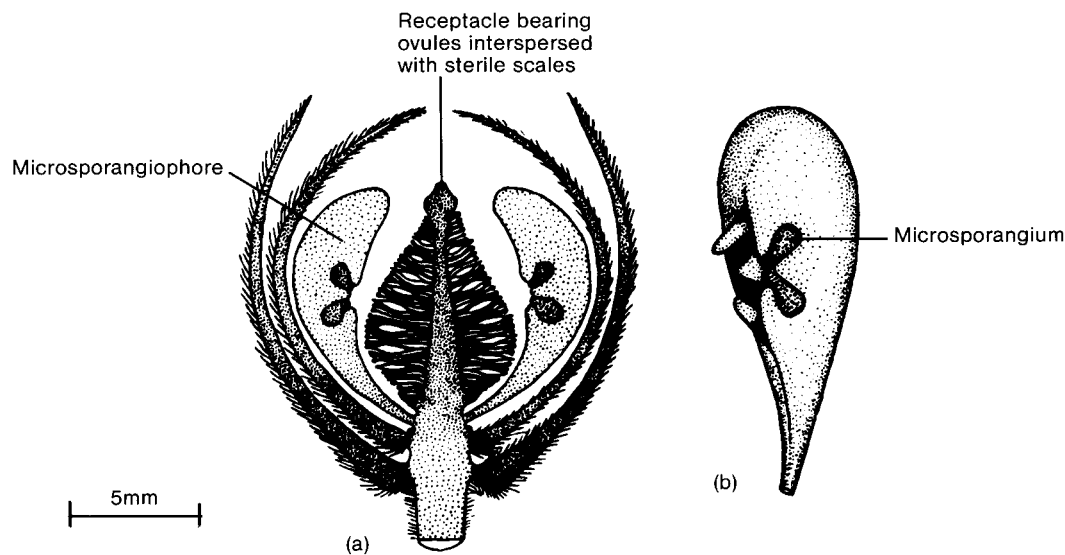

Figure 8.45 *Williamsoniella coronata* (Bennettitales).
 (a) Longitudinal section of fertile shoot. (b) Microsporangiophore showing partially enclosed microsporangia.
 (After Harris, from Stewart. 1983. *Paleobotany and the Evolution of Plants*. Cambridge University Press, New York.)

a heterogeneous assemblage of Mesozoic seed plants with no living representatives. The *Corystospermaceae*, from the Triassic of South Africa, were characterized by ovules with a curved micropylar “beak”. In *Umkomasia*, which was probably a woodland deciduous tree, the leaves were of the doubly pinnate kind known as *Dicroidium* (a form genus). The female reproductive structure was a pinnate branchlet bearing several recurved cupules in opposite pairs (Fig. 8.46A). Each cupule contained a single ovule, the curved micropylar beak (Fig. 8.46B) projecting conspicuously from the cupule. The male branchlet (known as *Pteruchus*, Fig. 8.46C) was very similar to *Crossotheca* (p. 224), but the pollen grains were bisaccate, with a well-defined colpus. Cupulate structures and fronds similar to those of the corystosperms are known from the Lower Cretaceous of Argentina, suggesting that the later members of the group were coexistent with the earliest angiosperms (p. 303).

Also known from the South African beds are the *Peltaspermaceae*. The leaves (*Lepidopteris*) of these plants were bipinnate fronds about 30 cm (12 in.) in length (Fig. 8.47A), characteristically

with blister-like swellings on the rachides and pinnales. The female branchlet was pinnately branched, each pinna terminating in a “cupulate disk”, attached centrally to the pedicel. Attached to the lower surface of the disk, and partly covered by its recurved margins, were up to 20 ovules, a curved “micropylar beak” sometimes being evident (Fig. 8.47B and C). Their form gives rise to the name *Peltaspermum* for these female units. The male branchlets were again similar to *Crossotheca*. Although known principally from South Africa, early peltasperms have also been reported from the late Permian of Western Europe.

The female reproductive branchlet of *Caytonia* (*Caytoniaceae*) was similar to that of the corystosperms, being a pinnately branched axis (Fig. 8.48a), about 5 cm (2 in.) or more in length and possibly dorsiventral in symmetry. The pinnae, more or less in opposite pairs, terminated in hollow spherical bodies about 0.5 cm (0.2 in.) in diameter (Fig. 8.48b). A pore, communicating with the interior of the sphere but concealed by a small flap of tissue, lay adjacent to the pedicel. Within the sphere was a series of up to 32 upright ovules, appearing platyspermic, each about 2.5 mm (0.1 in.) in length, and the nucellus furnished with a short micropylar beak. The ovules were arranged in lines, more or less opposite the basal pore.

The pollen organs of *Caytonia* (*Caytonanthus*) were branching clusters of elongate, pendent synangia, each with four loculi (Fig. 8.48c). The pollen

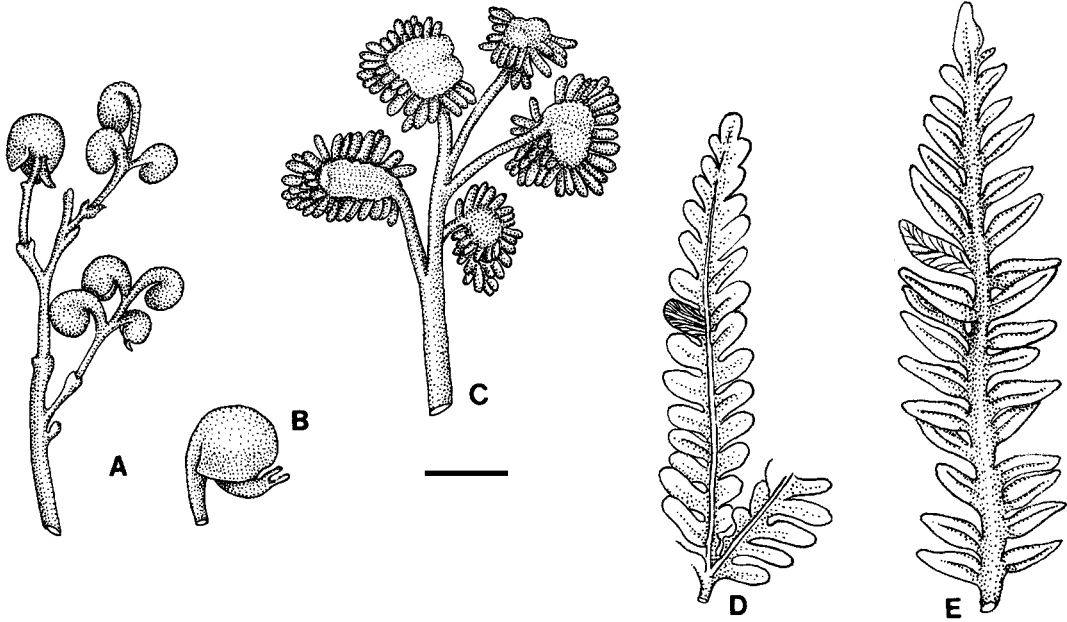

Figure 8.46 Triassic Corytospermaceae bore (A and B) ovules (*Umkomasia*) in clusters on short branches. Pollen organs (C) consisted of a disk-like lamina with numerous pendent microsporangia. The leaves (D and E), referred to the form genus *Dicroidium*, had a basal dichotomy. Scale bar 1 cm. (From Stewart and Rothwell. 1993. *Paleobotany and the Evolution of Plants*, 2nd edn. Cambridge University Press, New York.)

was bisaccate, and similar to that of the corytosperm *Pteruchus*, but lacked a well-defined colpus.

The leaves of *Caytonia* (*Sagenopteris*), about 6 cm (2.5 in.) in length, were palmately compound, consisting of usually four leaflets (Fig. 8.48d), each resembling in shape and reticulate venation the leaves of *Glossopteris* (p. 258). The stomata were haplocheilic.

Caytonia extends from the Upper Triassic to the Lower Cretaceous, and had a wide northern hemisphere distribution. Since pollen has been found in the micropyles of the ovules of *Caytonia*, the plant was evidently a gymnosperm.

The general features of the Caytoniales, particularly the tendency for the ovules to be borne within, or to be partially, or wholly, enclosed by a cupule-like structure, indicate that their origin, like that of the Bennettitales, is likely to have been in the late Paleozoic forms of the pteridosperms.

The Glossopteridales

The glossopterids were an enigmatic group of gymnosperms with complex and peculiar reproductive structures. They were abundant in the southern hemisphere in the Permian and Triassic. *Glossopteris* was a large, probably deciduous, tree, the trunk reaching 40 cm (16 in.) in diameter (Fig. 8.49a). The wood was pycnoxylic, and the pitting araucarian. The roots (*Vertebraria*) had characteristic radiating wedges of secondary xylem, a feature thought possibly to indicate a semi-aquatic habitat. The leaves were elongate-ovate with a distinct central midrib, probably borne with a spiral phyllotaxy. The lateral veins commonly anastomosed, yielding a reticulate mesh (Fig. 8.49b).

The reproductive organs were peculiar and complex, and those of both sexes were associated with leaves. The ovules were borne on short stalks, believed to have been axial to the leaf in origin, but becoming adnate to the midrib, either ontogenetically or phylogenetically. In some forms the stalk supported a small lamina, about 6 mm (0.2 in.) wide, bearing a cluster of ovules on the adaxial side and partially enclosing them with its inrolled margins (Fig. 8.50). In later forms the clusters of ovules were open, each ovule almost entirely surrounded by its own lamina. In general

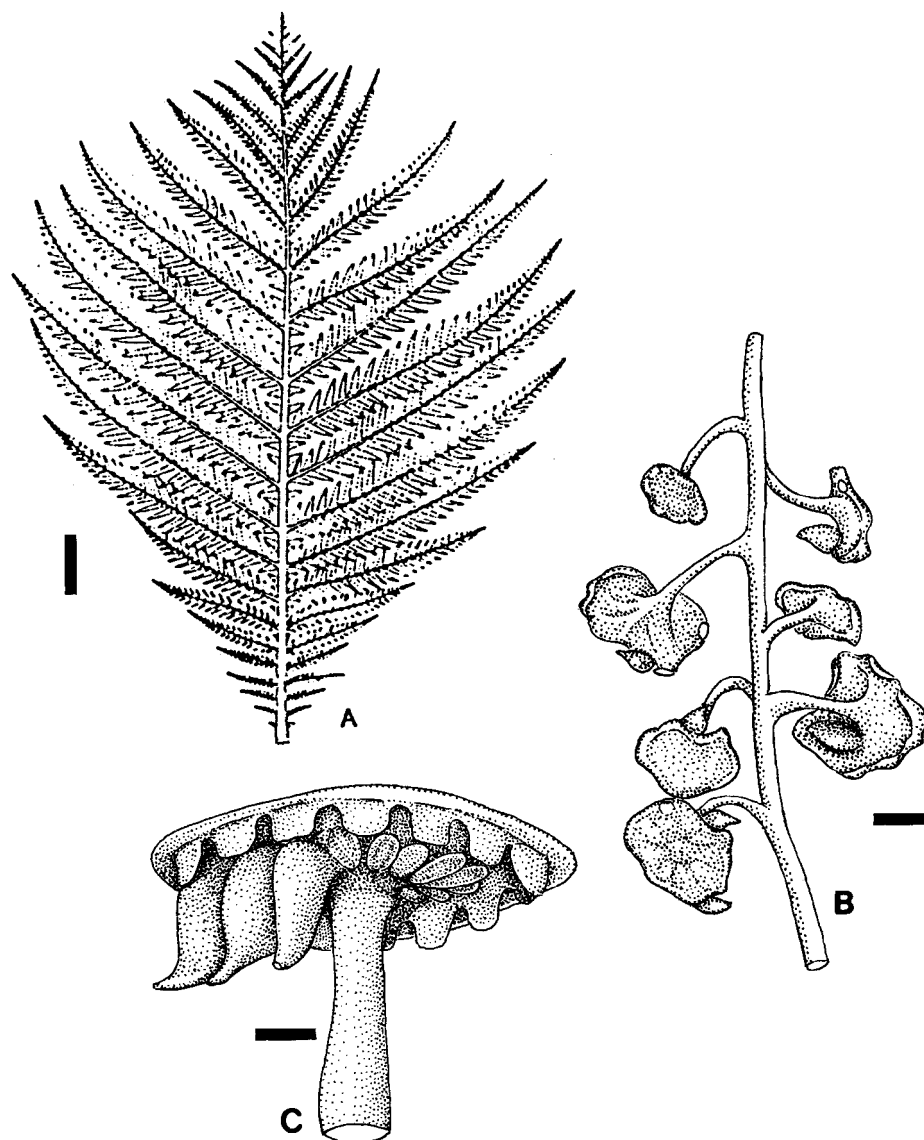

Figure 8.47 Triassic Peltaspermeaceae had large fern-like leaves (A), referred to the form genus *Lepidopteris*. Ovules were pendent from the lower surface of disk-like cupules (B and C). Scale bars: (A) 2 cm; (B) 1 cm; (C) 1 mm. ((A) from Hughes, 1994. *The Enigma of Angiosperm Origins*. Cambridge University Press, Cambridge; (B), (C) from Stewart and Rothwell, 1993. *Paleobotany and the Evolution of Plants*, 2nd edn. Cambridge University Press, New York.)

the ovules were platyspermic, barely reaching 2 mm (0.8 in.) in length. Bisaccate pollen grains have been observed within the pollen chambers.

In the male organ (*Eretmonia*), solitary or paired clusters of microsporangia were borne on a

stalk arising from the midrib of a leaf, the position corresponding to that bearing the ovules in the female organ.

Glossopterids are known to have occurred at high latitudes in the southern hemisphere (Gondwana). They may have formed a conspicuous part of the polar ecosystem at the close of the Paleozoic era, a system of which there are no modern parallels. The particularly prominent and wide growth rings of some glossopterid stems suggests that they may have grown continuously over the long days of the polar summer. They would have escaped the diurnal cycle of lower latitudes,

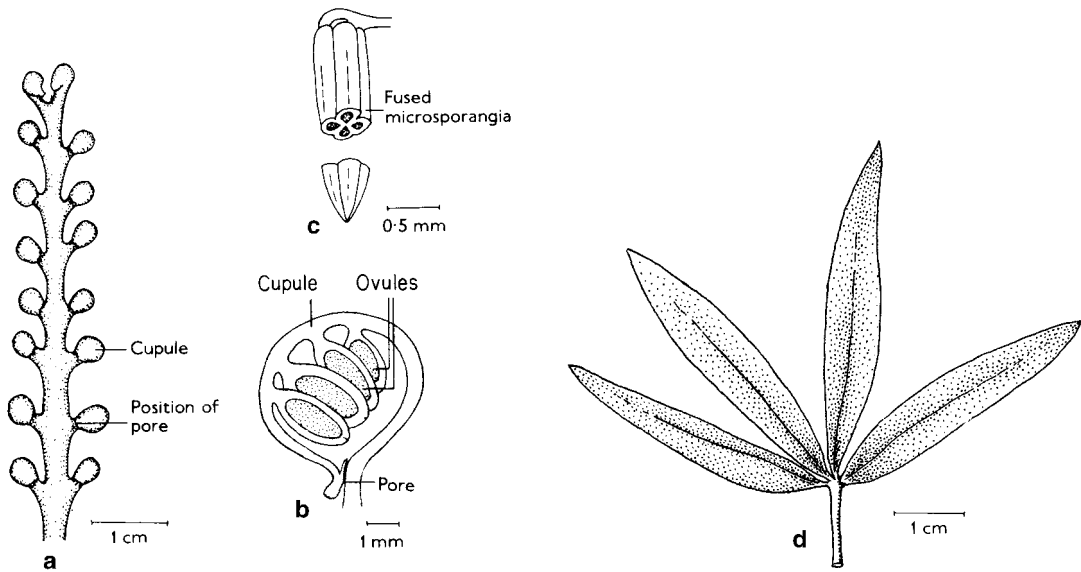

Figure 8.48 *Caytonia nathorsti*. (a) Reconstruction of fertile shoot. (b) Longitudinal section of cupule. (c) *Caytonanthus kochi*, reconstruction. (d) *Sagenopteris phillipsi*. ((a), (b) after Thomas, from Andrews. 1961. *Studies in Paleobotany*. Wiley, New York; (c) after Harris, from Andrews. 1961. *Studies in Paleobotany*. Wiley, New York; (d) from Stewart and Rothwell. 1993. *Paleobotany and the Evolution of Plants*, 2nd edn. Cambridge University Press, New York.)

and the physiological limits which this imposes on the rate of wood production.

The reticulate venation in the leaves of the glossopterids, coupled with the carpel-like lamina associated with the ovules in some forms, have led to their being considered as possible ancestors of the flowering plants. There is, however, no clear evidence for such a relationship. The glossopterids were extinct by the end of the Triassic.

The Pentoxylales

The Pentoxylales, known only from the Jurassic, are poorly understood, but possibly of importance in relation to the origin of the angiosperms. The stems of *Pentoxylon* (Fig. 8.51A) commonly contained five distinct segments of vascular tissue, consisting principally of pycnoxylic secondary xylem. The primary xylem was mesarch. The plant, which was presumably a small tree or shrub, produced long and short shoots in the manner of *Ginkgo*. Both bore entire ovate leaves about 7 cm (3 in.) in length, and with syndeto-

cheilic stomata on the lower surface. Female cones were borne on solitary or branched pedicels arising from the short shoots. They consisted of densely packed, spirally arranged ovules (Fig. 8.51B), each with a bulky integument. The microspyle was placed centrally in each outer face. The male reproductive structure, borne terminally on separate short shoots, consisted of a ring of filiform axes, fused at the base and spirally branched above. The branches terminated in unilocular microsporangia. The pollen was monocolpate and similar to that of cycads.

The Pentoxylales are very difficult to classify. Like the Ginkgoopsida, they seem to have been an entirely separate group of plants, presumably originating from somewhere within the wide range of Paleozoic pteridosperms. Cladistic analyses, utilizing a multiplicity of characters, suggest a relationship with the Bennettitales (Fig. 8.3).

Another plant, well preserved but of at present entirely obscure affinities, is *Sanmiguelia* from the Upper Triassic of North America. Erect stems, bearing apparently plicate leaves, rose from a basal rhizome (Fig. 8.52A). The venation was reticulate, and each leaf had a sheathing base which encircled the stem. Vessels occurred in the root. Male and female reproductive regions were separate, and appeared to terminate stems and lateral branches. Male "cones" consisted of paired microsporangia spirally arranged on a short axis.

Figure 8.49 *Glossopteris*.

Reconstruction of a specimen about 4 m (14 ft) in height. Scale bar in (b) 1 cm. (Based on Gould and Delevoryas, from Stewart and Rothwell. 1993. *Paleobotany and the Evolution of Plants*, 2nd edn. Cambridge University Press, New York.)

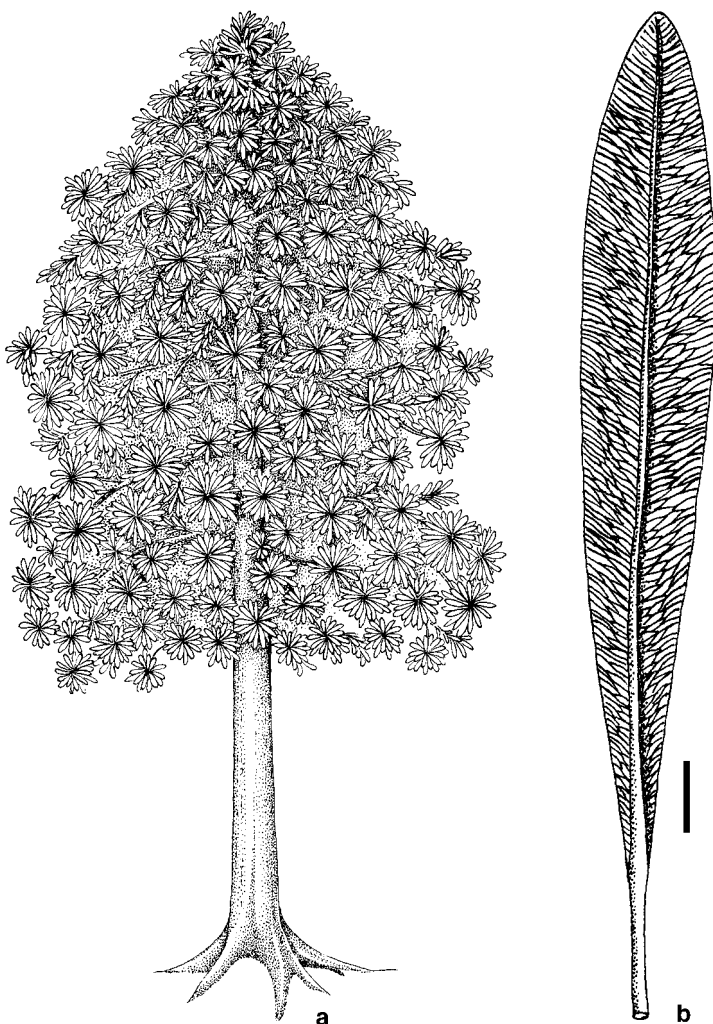
**Figure 8.50** *Glossopteris*.

Diagrammatic representation of the female reproductive region. The leaf-like megasporangiophore was borne in the axil of a foliage leaf. (From information in Gould and Delevoryas. 1977. *Alcheringa* 1, and Taylor and Taylor. 1992. *Proceedings of the National Academy of Sciences U.S.A.* 89.)

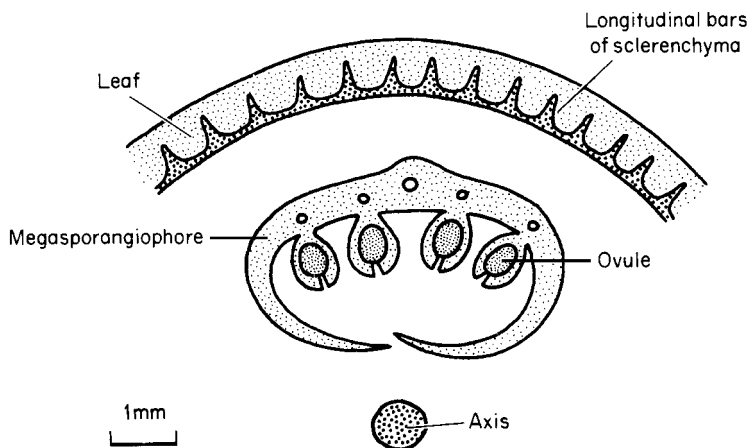

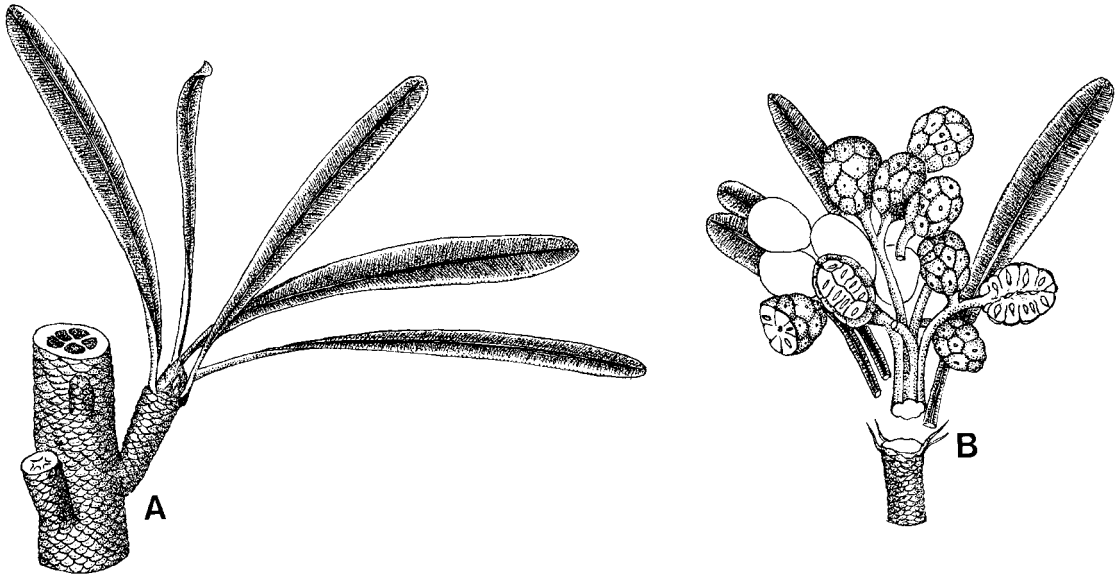

Figure 8.51 *Pentoxylon sahnii*. (A) An axis about 1 cm (0.4 in.) in diameter, bearing a short shoot, from the Indian Jurassic. (B) A short shoot with ovulate cones. (After Sahn, from Stewart and Rothwell, 1993. *Paleobotany and the Evolution of Plants*, 2nd edn. Cambridge University Press, New York.)

Numerous such axes occurred in helical arrangement at the termination of a branch. The female unit consisted of clusters of cupules subtended by bracts (Fig. 8.52B), arising either terminally or in the axils of leaves. Although the detail is not adequate to be certain, each cupule probably contained a pair of recurved ovules, each with two integuments. Despite its possessing a number of angiospermous features, *Sanmiguelia* is best regarded as a specialized gymnosperm, some of the specializations (e.g., its carpel-like cupules) being shared with angiosperms.

Gnetopsida

The class Gnetopsida consists of three extant orders: Gnetales, Welwitschiales and Ephedrales. Each order is monogeneric and one (Welwitschiales) monospecific. Not only are the Gnetopsida very different from other gymnosperms, but the orders also differ markedly amongst themselves. They have been extensively studied by morphologists because of certain features which make them appear intermediate between gymnosperms and angiosperms.

However, although the Gnetopsida indicate how certain characteristics of angiosperms may have arisen, they themselves appear to be as derived as the angiosperms, and cannot be considered as having participated in angiosperm ancestry. The Gnetopsida are united by the presence of vessels in their secondary xylem, and the tendency for the tip of the nucellus to be extended as a micropylar tube. In *Gnetum* and *Welwitschia* the female gametophyte takes the form of an embryo sac.

Unfortunately the fossil record of the Gnetopsida is very fragmentary and does not extend further back than the Cretaceous. *Drewria* (Fig. 8.53) has features of leaf venation similar to those of the leaves of *Welwitschia* (p. 263), and similar dichasial reproductive structures. There is also a resemblance in this respect to the Chloranthaceae, believed to be primitive dicotyledons (Magnoliopsida, p. 303). Nevertheless, *Welwitschia* is such a bizarre plant that the significance of such resemblances is altogether doubtful.

The Gnetales

The genus *Gnetum* is exclusively tropical, occurring in Asia, Africa and South America. Many species are lianes, but others are small trees. The leaves are well developed (Fig. 8.54), and possess broad, oval laminae with reticulate venation, some of the veins ending blindly in areolae.



Figure 8.52 *Sanmiguelia lewisii*. (A) Male and (B) female reproductive shoots. The larger leaves were 48–60 cm (19–24 in.) long and 28–31 cm (11–12 in.) broad. (From Cornet, 1986. *Evolutionary Theory* 7.)

Vegetatively, therefore, *Gnetum* has very much the appearance of an angiosperm.

The stem of *Gnetum* usually has a small pith, surrounded by a little primary xylem. Most of the xylem is secondary and is interspersed with broad parenchymatous rays. In the climbing forms the stem is eccentric, and successive cambia give rise to a polycyclic stelar structure, and asymmetry in any particular region depending upon its spatial orientation. In general features, therefore, the stem is closer to that of the cycads and pteridosperms than to that of the conifers. A striking difference, however, is the differentiation of authentic vessels in the secondary xylem. Another notable feature in *Gnetum* is the close association between parenchymatous cells, recalling the companion cells of angiosperms, and the

sieve cells. The cortex adjacent to the phloem is rich in fibers, occasionally used as cord. In some species the stems contain laticifers, one of the very few instances of these tissue elements occurring outside the flowering plants.

The placing of *Gnetum* in the gymnosperms is justified by the nature of its reproduction. Both male and female reproductive regions are strobili, usually terminating lateral axes, although some species show cauliflory. In the male strobilus (Fig. 8.55a) the axis bears a succession of gallery-like sheaths, usually about eight in number, probably formed from coalesced bracts. In the axil of each sheath are whorls of male flowers, in some species surmounted by whorls of abortive ovules. The male flower (Fig. 8.55b) consists of a single microsporangiophore, terminating in two microsporangia, surrounded at its base by a delicate membranous sheath. The pollen grains are spherical, inaperturate or with widely dispersed pores. They are trinucleate when shed, one nucleus probably being prothallial.

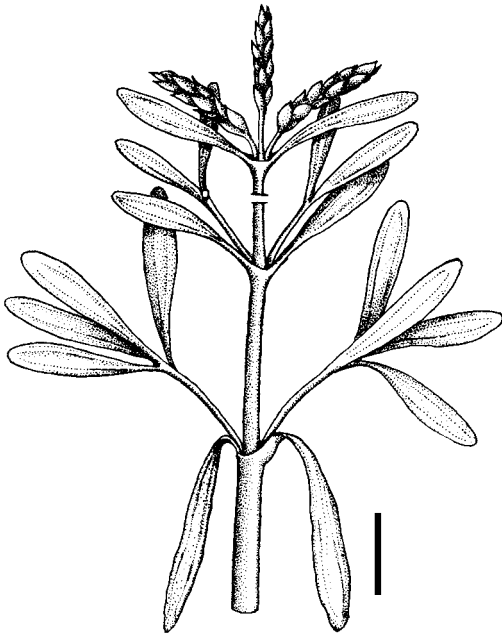

Figure 8.53 *Drewria potamacensis*. Reconstruction of a vegetative and (above) a terminally fertile shoot. Scale bar 1 cm. (After Crane and Upchurch, from Stewart and Rothwell, 1993. *Paleobotany and the Evolution of Plants*, 2nd edn. Cambridge University Press, New York.)

In the female strobilus (Fig. 8.55c) each sheath encloses a whorl of female flowers. Each flower consists of a single, radially symmetrical ovule (Fig. 8.56a) surrounded by three integuments, the outer of which is possibly homologous with the basal sheath of the male flower. The inner integument is extended into a cutinized micropyle, and the nucellus beneath becomes transformed into a pollen chamber. One or more of the tetrad of megaspores formed in the nucellus enters into the formation of the acellular female gametophyte.

Pollination is by wind, and also by insects, attracted to the male flowers by the sugary pollination drops of the adjacent abortive ovules, and subsequently transferring the pollen to functional female strobili. The entry of the pollen into the micropyles of functional ovules initiates renewed growth of the ovule. The germinating grains, trapped by the proliferation of the cells lining the micropyle, send pollen tubes into the nucellus. Meanwhile the female gametophyte completes its development. At maturity it is shaped like an

inverted flask (Fig. 8.56b), commonly called (by analogy with the angiosperms) an embryo sac. Much of the cytoplasm, in which the nuclei are irregularly scattered, lies at the base of the sac, but the remainder is distributed as a thick layer around the periphery, a large vacuole occupying the center. While the embryo sac is completing its development, the pollen tubes, having penetrated the nucellus, approach the sac. One of the nuclei in the male gametophyte moves to the tip of the tube and divides into two sperm nuclei. Meanwhile one or more nuclei in the upper part of the embryo sac in the region adjacent to the closest pollen tube become conspicuously large. The pollen tube, having by now made contact with the sac, discharges the two sperm nuclei into it. Microspectrofluorometry has shown that the sperm nuclei at the time of discharge have already replicated their DNA, so that they contain twice the basic (2C) amount. The male nuclei immediately migrate to the nearby large nuclei of the sac, which can thus be identified as egg nuclei. There is no clear segregation of egg cells or nuclei within the sac, and both sperm nuclei from the pollen tube may enter into fusions.

The entry of the male nuclei stimulates general division of the somatic nuclei within the embryo sac. The contents of the sac become cellular, the cells often containing several nuclei, which subsequently fuse. The male nucleus and egg nucleus meanwhile coalesce and form a zygote lying within what can now be regarded as equivalent to a cellular endosperm. Development of the zygote proceeds at once, presumably because the egg nucleus, like the sperm nucleus, has already replicated its DNA. Karyogamy would then result in a zygotic nucleus with the premitotic 4C amount necessary for the maintenance of the diploid condition (cf. *Pteridium*, p. 207). Early development does not involve any free nuclear division. A complicated suspensor, possibly partly haustorial in function, is formed before the embryo proper. Although, since more than one egg nucleus may be present in the embryo sac and several male nuclei may be discharged into it, there is potential polyembryony, only one embryo usually comes to maturity. The embryo has two cotyledons.

Although the reproductive apparatus is quite

Figure 8.54 *Gnetum gnemon*.

Portion of a shoot bearing female strobili. Scale bar 5 cm. (After Madhulata, from Maheshwari and Vasil. 1961. *Gnetum*. CSIR, Delhi.)

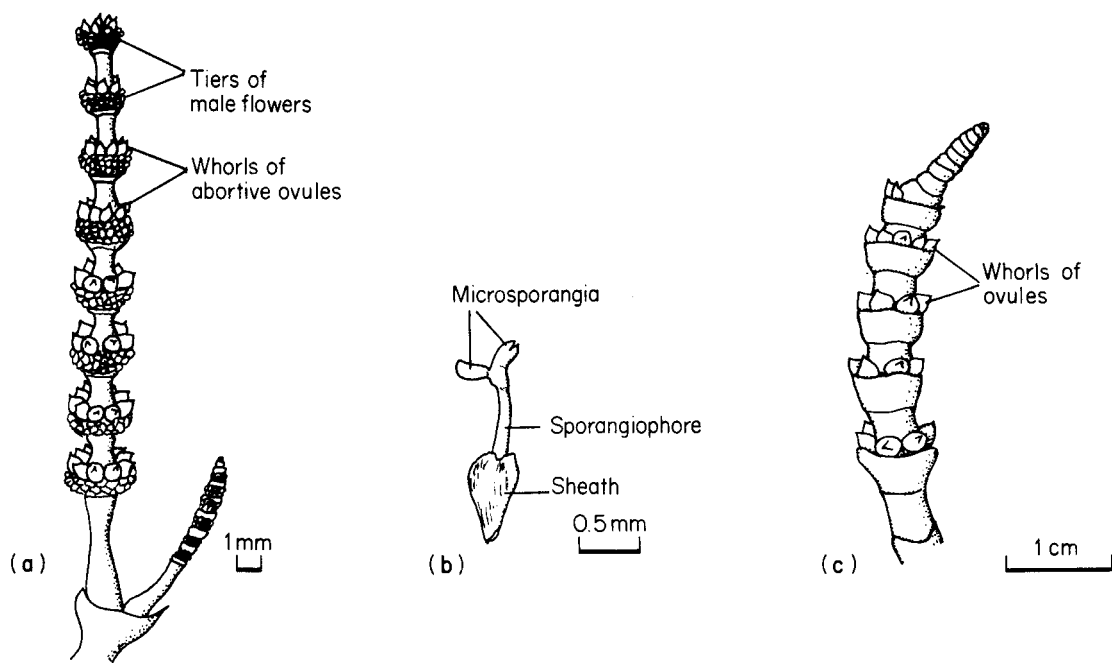
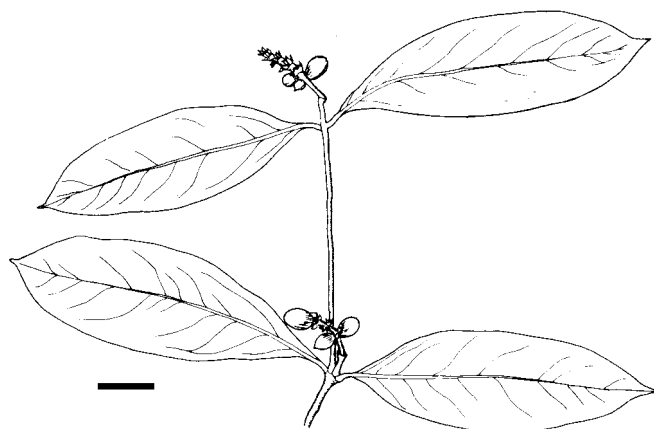

Figure 8.55 *Gnetum gnemon*. (a) Young microsporangiate strobilus with whorls of abortive ovules. (b) Dehiscent microsporangia. (c) Megasporangiate strobilus. (From Maheshwari and Vasil. 1961. *Gnetum*. CSIR, Delhi.)

different, the seed of *Gnetum* recalls that of some Bennettitales. When ripe, the outer integuments of the *Gnetum* seed become fleshy, and in some species are edible. *Gnetum gnemon* is functionally dioecious, male and female strobili being formed on separate plants, but the situation in other species is not clear.

The Welwitschiales

In respect of habit *Welwitschia* (Fig. 8.57) is one of the most peculiar plants in existence. The genus is monotypic, and the single species is confined to desert regions of southwest Africa. The stem is short and upright, and mostly below soil level. At the upper end it bears two strap-shaped leaves with indefinite basal growth. Developmentally these are the first pair of leaves after the cotyledons, and growth soon becomes confined to them. A further pair of decussate leaf primordia is formed in the young plant, but these differentiate

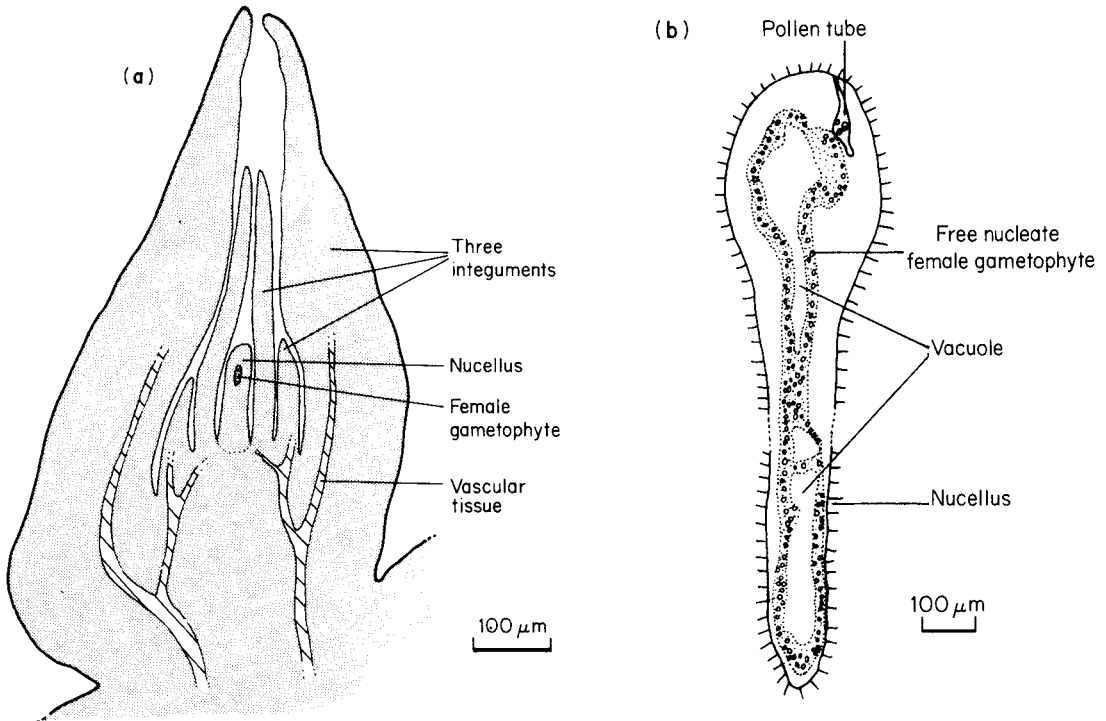

Figure 8.56 *Gnetum ula*. (a) Longitudinal section of very young ovule. (b) Longitudinal section of mature female gametophyte (embryo sac) showing entry of pollen tube. (After Vasil, from Maheshwari and Vasil. 1961. *Gnetum*. CSIR, Delhi.)

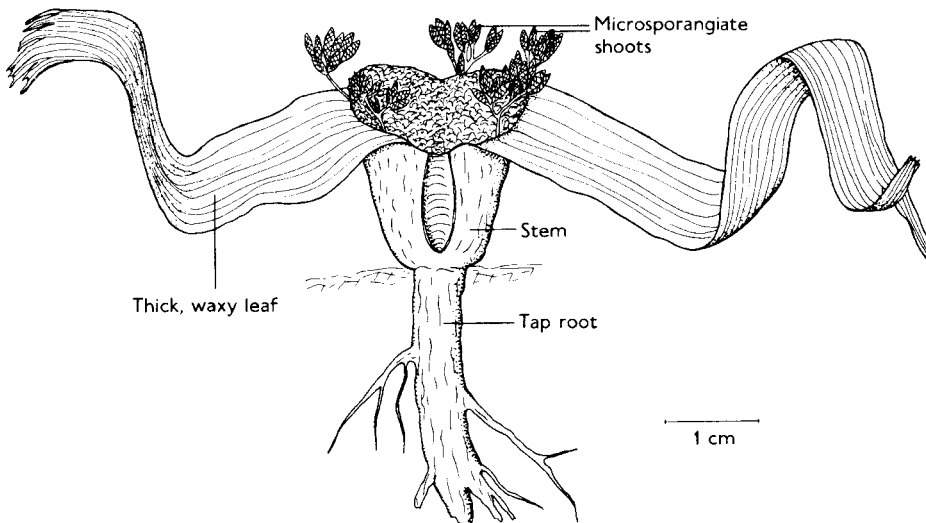
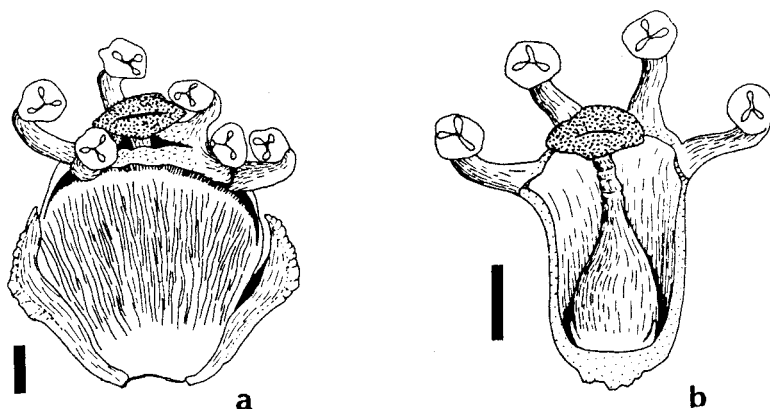

Figure 8.57 *Welwitschia mirabilis*. Habit of the male plant. (After Hooker. 1863. *Transactions of the Linnean Society*, London 24.)

Figure 8.58 *Welwitschia*. (a) The male flower, enclosed by two pairs of decussate bracts. (b) The stamens, the filaments fused below into a membranous tube, surround a sterile ovule. Scale bars 1 mm.



into horn-like protuberances. Below, the stem passes into a long tap root which gives rise to an extensive root system. The stem contains much secondary tissue, and it shows anatomical peculiarities similar to those found in *Gnetum* and *Ephedra*.

Welwitschia is dioecious, the cone-like reproductive structures terminating small dichasial branch systems arising in the axils of the leaves (Fig. 8.57). The cones consist of a series of scales, arranged in decussate pairs, in the axils of which are the individual flowers. The male units consist of a short axis bearing, first, two decussate pairs of small scales, and then a ring of trilobular synangia. The filaments supporting the synangia are fused together at the base into a membranous cylinder (Fig. 8.58). In the center of the unit, and terminating its short axis, is an abortive ovule. The pollen grains are binucleate when shed, but neither nucleus can be regarded as belonging to a prothallial cell.

The female unit consists solely of an ovule with two integuments, terminating an axis with occasionally two minute lateral outgrowths. The outer integument, which is broadly winged tangentially to the cone and is traversed by several vascular bundles, may be homologous with the upper pair of bracteoles of the male flower. The membranous inner integument is extended at its apex into a cutinized micropylar tube. The basic symmetry of the ovule seems to be radial rather than bilateral.

Pollination and the initiation of the embryo sac take place much as in *Gnetum*, but in the later stages, especially at the time of pollination, there are features peculiar to *Welwitschia*. After the initial free nuclear division in the sac, walls are laid down, many of the cells so formed being multinucleate. As the pollen tubes penetrate the nucellus, some of the multinucleate cells in the

upper part of the embryo sac give rise to tubular processes. These grow up toward the descending pollen tubes and potential egg nuclei move to their tips. When a pollen tube and process make contact the separating walls dissolve and the sperm and egg nuclei fuse. The zygote then becomes ensheathed in cytoplasm and a cell membrane forms. There is no free nuclear division in the development of the zygote. A suspensor is formed and below it the embryo proper. Only one zygote yields a mature embryo. There are two cotyledons. In fruit the outer integument of the seed persists as a broad wing which assists aerial dispersal.

The Ephedrales

The genus *Ephedra* is widely but discontinuously distributed. Some 35 species occur in the Mediterranean region, Asia and the Americas. They are typical "switch plants", consisting of densely branched axes, the younger of which are green and photosynthetic (Fig. 8.59). The leaves consist of whorls of small scales which soon become scarios. Many species grow in extremely arid situations, such as sand dunes and scree slopes, and these not unexpectedly have an extensive root system. The young twigs of some species have medicinal uses, and the genus is the source of the alkaloid ephedrine.

The stem of *Ephedra* grows from a group of meristematic cells, and a distinct tunica and corpus are recognizable in the apex. The primary vascular system consists of a number of bundles symmetrically placed around a central pith (Fig. 8.60), the bundles being linked at the nodes by a

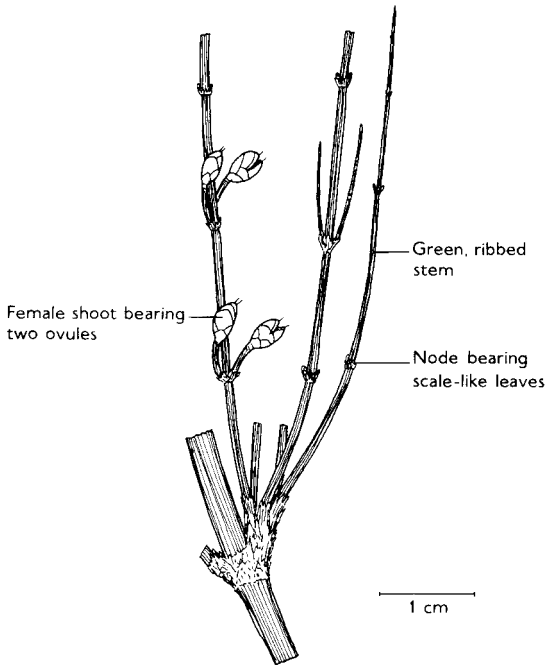

Figure 8.59 *Ephedra* sp. Portion of shoot system showing the articulated stem, reduced leaves, and female reproductive structures.

transverse vascular ring, as in *Equisetum*. The primary xylem becomes surrounded by secondary, traversed by broad parenchymatous rays. The tracheids have bordered pits on their radial walls, well-developed tori also being present. Many of the tracheids are arranged in columns, and the end walls are so extensively perforated that they can be legitimately regarded as vessel segments with foraminated perforation plates. The phloem consists of sieve cells and parenchyma, the sieve cells, like those of the conifers, having highly inclined end walls.

Ephedra is dioecious. The male reproductive regions are cone-like terminations of short shoots which arise in the axils of the scale leaves. The short shoot bears a number of bracts in decussate pairs, and in the axil of each bract is a male unit (Fig. 8.61). This consists of a single microsporangophore, enclosed in the basal region by two medianly placed bracteoles, and bearing at its summit 2–8 microsporangia. The pollen grains are ellipsoidal and furnished with prominent longitudinal ridges. Nuclear divisions occur immediately after the formation of the grains and when mature they contain four or five nuclei. The first two daughter nuclei, which do not again divide, are regarded as prothallial.

The female reproductive organ is similar in structure to the male, but only the uppermost

Figure 8.60 *Ephedra* sp.
Transverse section of young stem.

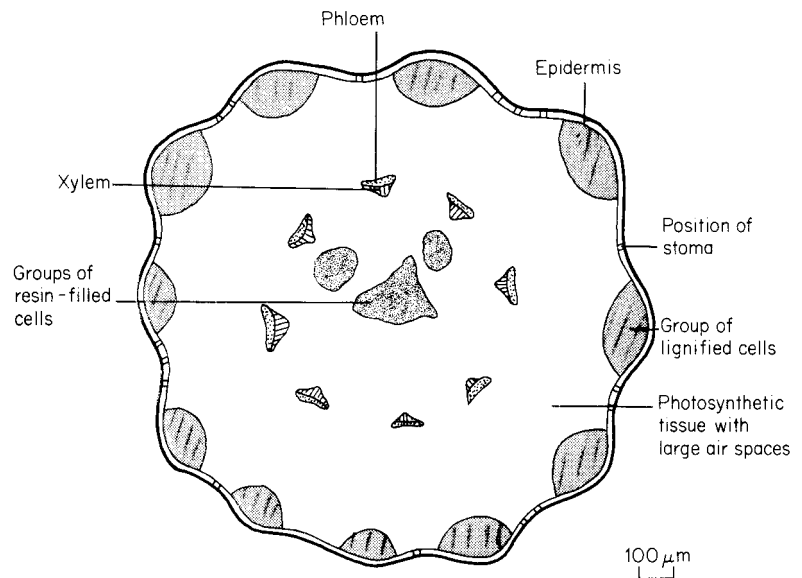
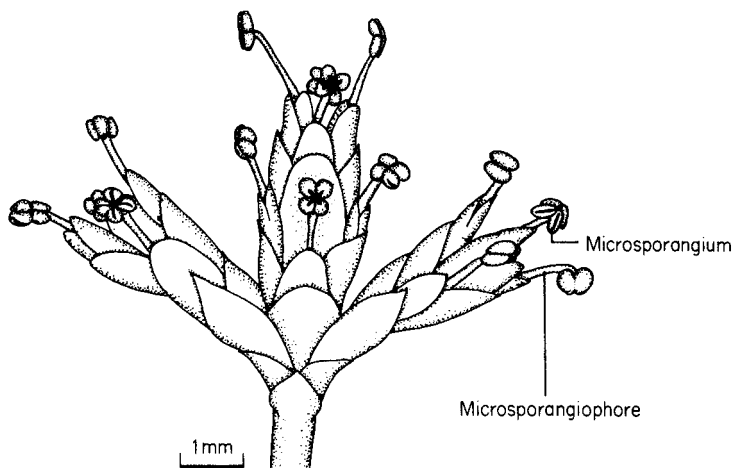

Figure 8.61 *Ephedra altissima*.
Microsporangiate shoot.

pair of bracts is fertile. Each subtends an upright ovule which is surrounded by a sheath, sometimes two-lipped above and probably homologous with the two bracteoles of the male flower. Hermaphrodite flowers are occasionally found. The radially symmetrical ovule (Fig. 8.62) is bounded by a papery integument, the apex of which is prolonged into a micropylar tube, highly cutinized at maturity. Megasporogenesis is initiated in the nucellus and in the usual way only one megaspore of the tetrad persists. The female gametophyte passes through



a period of free nuclear division before becoming cellular. Two, rarely more, archegonia are differentiated at the micropylar end, and they are unusual in being quite deeply sunken into the somatic tissue of the gametophyte. Although the cytology within the archegonium is normal, following division of the central cell nucleus there is no cytokinesis, and the ventral canal nucleus remains in the upper part of the now binucleate cell. As the archegonia mature, the upper part of the nucellus breaks down to form a pollen chamber, and complex cytological phenomena, amongst them the amoeboid migration of nuclei and endomitosis, occur in the upper cells of the gametophyte. A prominent "pollination drop" forms at the orifice of the micropyle (Fig. 8.63).

The pollen is distributed by wind and possibly also by insects attracted by the sugary pollination drop produced by non-fertile ovules associated with the male flowers of some species. Germination of the pollen occurs directly on the surface of the female gametophyte and a pollen tube pushes its way into an archegonium. Two sperm nuclei, produced by division of the spermatogenous cell, enter the egg cell. One fuses with the egg nucleus and the other, in some species at least, regularly fuses with the ventral canal nucleus (a form of double fertilization). Both fusion products undergo mitoses and eight proembryos may result. There is thus potential polyembryony, but only one embryo normally reaches maturity. A suspensor, of complex and compound origin, drives the surviving embryo into the

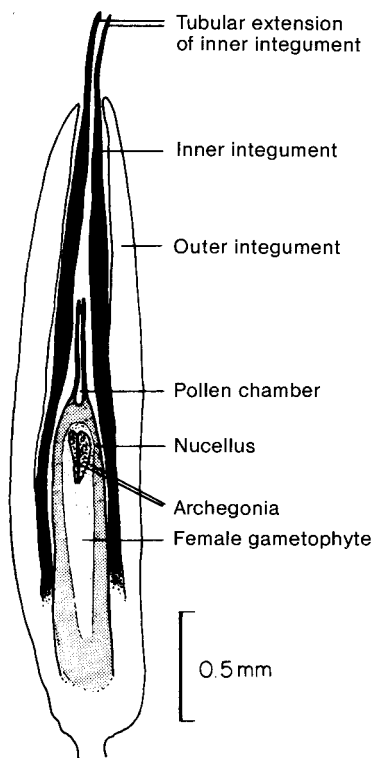

Figure 8.62 *Ephedra* sp. Longitudinal section of ovule with archegonia. (From a photograph by W. R. Ivimey-Cook, in McLean and Ivimey-Cook. 1951. *Textbook of Theoretical Botany*. Longman, London.)



Figure 8.63 *Ephedra*. Pollination drop secreted from the tip of the slender micropylar tube of a mature ovule. Scale bar 1 mm. (Photograph by W. E. Friedman, reproduced by permission of the American Botanical Society.)

central region of the female gametophyte, rich in food reserves. The mature embryo has two cotyledons and lies surrounded by the membranous remains of the ovular tissues and the hardened integument. Reproduction in *Ephedra* is more rapid than in the conifers; the interval between pollination and fertilization may amount to no more than 24 hours in *Ephedra* (cf. *Pinus*, p. 238).

The “double fertilization” in *Ephedra* has been held to be relevant to the origin of the formation of endosperm in flowering plants (p. 298).

In many species of *Ephedra* the bracts below the ovules become hard and wing-like in fruit, but in the alpine *E. helvetica* they become fleshy and brightly pigmented.

Gymnospermy as an evolutionary grade

The diversity of the gymnosperms taken as a whole, in both vegetative and reproductive features, indicates that gymnospermy must be regarded as a grade of evolutionary advance, probably first attained in the second half of the

Devonian period. The seed habit may of course have arisen independently more than once in groups of plants at the progymnospermous level of evolution. This would be in line with the overlapping of the progymnosperms and gymnosperms in geological time, and the diversity present in both. Within the gymnosperms, for example, the affinities of the cycads appear to be pteridospermous, those of *Ginkgo* cordaitalean. Here then are two groups of plants whose evolution has probably been independent for many millions of years, but which are at the same level of advancement in respect of the reproductive process. A number of features in these primitive seed plants may have evolved in parallel. Siphonogamy, for example, may have arisen independently in the Pinopsida and the Gnetopsida. Similarly, the symmetry of the ovule, although it is useful to distinguish between radiospermy and platyspermy in the early seeds, may also have been a feature which responded independently to reproductive specialization in the evolving lineages. The ovules of *Caytonia* (p. 254), for example, appear to be platyspermic, although the affinities of the plant seem undoubtedly to be with the later radiospermic pteridosperms.

The highest grade of gymnospermy is clearly shown by the Gnetopsida. The peculiarities of the female gametophyte in *Gnetum* and *Welwitschia* indicate the kind of developments which, in some early transitional forms, may have led to the angiospermous embryo sac. Although there are differences in the manner of their formation,

the vessels of the Gnetopsida also foreshadow those of the angiosperms. Further, studies of the nucleotide sequences of the nucleic acids show that those of the Gnetopsida more closely resemble those of the angiosperms than any other seed plants. This agrees well with those cladistic analyses of seed plants which, utilizing morphological characters, can include fossils. However, recent and more penetrating comparative analyses of the nuclear, mitochondrial and chloroplast genomes of a range of representative plants have indicated that the affinities of the Gnetopsida lie within the conifers, the Pinopsida and the Gnetopsida forming sister groups. The angiosperm-like features of the Gnetopsida may thus have arisen independently. The origin of the angiosperms may even have preceded the emergence of the Gnetopsida, lying in a more ancient stock of seed plants, possibly identical with that which gave rise to the Bennettitales and Pentoxylales (although such a remote origin would be difficult to reconcile with comparatively late appearance of fossil angiosperm pollen (see p. 303)). Further discussion of the implications of the recent unexpected molecular discoveries will be found in *The Proceedings of the National Academy of Sciences U. S. A.*, volume 97, pp. 4086-4097 (2000). Taking the wider view, the relationship between the gymnosperms and the angiosperms is analogous to that between the progymnosperms and the gymnosperms, the latter in each case being a specialized subset of the former.

The subkingdom Embryophyta (cont.): division Tracheophyta, Part 4

SPERMATOPHYTINA (cont.): ANGIOSPERMS (flowering plants)

The angiosperms are the most abundant and widely distributed of the seed-bearing tracheophytes. They are of outstanding economic importance, being the source of many durable hardwoods, most of our vegetable foodstuffs, and about one-quarter (in monetary value) of commercially marketed drugs. They number some 250 000 species and show remarkable diversity in growth form, morphology and physiology.

The general features of the angiosperms can be summarized as follows:

Sporophyte herbaceous or arborescent; branching usually axillary. Leaves various, but regarded as megaphyllous in origin. Secondary vascular tissue commonly present. Vascular system usually consisting of vessels and tracheids, and sieve tubes with distinctive companion cells. Heterospory as in the gymnosperms, but the ovules borne within a characteristic structure (carpel), usually closed, the pollen germinating on a specialized region of the exterior (stigma). Female gametophyte always an embryo sac, lacking archegonia. Male cells (sperms) lacking specialized means of locomotion, released into the embryo sac from the filamentous male gametophyte (siphonogamy). Fertilization characteristically double, yielding in each embryo sac a zygote and a mostly triploid endosperm nucleus. Embryogeny endoscopic. Various forms of asexual reproduction not uncommon.

Magnoliopsida and Liliopsida

The angiosperms fall into two major classes, the Magnoliopsida (dicotyledons) and the Liliopsida (monocotyledons), in which the embryos are commonly furnished with two or only one cotyledon respectively. These groups also differ in many other features, with distinct trends in leaf venation and form, and flower symmetry. It is, nonetheless, convenient to consider them together because of the wealth of shared characteristics. The split into two classes is largely one of expediency, since it facilitates the classification of the enormous diversity of the existing flower-bearing spermatophytes.

The evolution of the two classes of angiosperms (of which the largest, and in part the most primitive, is the Magnoliopsida) has many different aspects. Of particular interest to systematists is the evolution of individual species, genera and families. Another approach, of more appeal to morphologists, is to consider the evolution of certain morphological or anatomical features (e.g., the form of leaves and the nature of vascular tissue) in the angiosperms as a whole. Unfortunately the amount of information the fossil record can offer directly on these points is limited. By the time the two classes of angiosperms become firmly identifiable (mid-Cretaceous) they are referable to a surprising extent to modern families and even genera. The inception of the angiosperms was evidently followed by a burst of radiative evolution which had a profound effect upon the Earth's flora and fauna. The enigmatic origin and evolution of the

Figure 9.1 Life forms of angiosperms. The circles indicate the positions of the resting buds. (a) Phanerophyte. (b) Chamaephyte. (c) Hemicryptophyte. (d) Cryptophyte. (e) Therophyte.

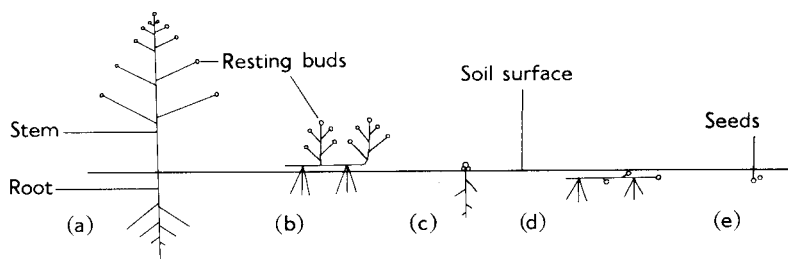

angiosperms will be considered after we have reviewed the main features of the two classes.

Growth forms of angiosperms

Examination of a tracheophyte flora (frequently consisting principally of angiosperms) will usually reveal that it consists of a number of distinct growth forms, ranging from large woody trees to minute herbs. The extent of the representation of these different morphologies in a given vegetation presents intricate ecological problems, the discussion of which is facilitated by Raunkiaer's concept of life forms. A life form is defined by the length of life of the shoots and the position and protection of the resting buds (Fig. 9.1). Those plants in which the shoots are persistent and the buds are carried well above the soil surface are termed *phanerophytes*, those with resting buds closer to the surface *chamaephytes*, and those with resting buds at the surface *hemicryptophytes*. Familiar examples of these three classes are, respectively, the larger woody plants, small bushes such as *Calluna* (heather), and rosette plants such as *Taraxacum* (dandelion). The classification, except for certain small specialized categories, is completed by the *cryptophytes* (geophytes) where the resting buds are below the soil surface, and the *therophytes*. The latter are those annuals and ephemerals which tide over unfavorable periods as embryos enclosed in seeds. By use of this classification it is possible to show in a precise statistical manner that, for example, the vegetation of the humid tropics consists predominantly of phanerophytes, and that in the northern hemisphere the percentage of hemicryptophytes in general increases with latitude (Table 9.1).

Although there is this evident relationship between life form and distribution, no less important in determining the distribution of individual species are such factors as mean minimum temperatures, the length of time available for gainful

photosynthesis in the yearly cycle, and the availability of moisture.

For convenience of description we can regard the plant body of an angiosperm as consisting of three morphological categories, stem, leaf and root, although, as we shall see later, there are good reasons for regarding the leaf as a megaphyll and hence of axial origin. The main stem is usually upright, displaying negative gravitropism and positive phototropism. Branching occurs in the axils of leaves. The final orientation of these laterals is probably determined by a combination of complex gravitropic and phototropic responses. Although such branch systems are usually aerial, they may be subterranean (when, of course, light will no longer affect morphogenesis). The genus *Parinarium*, for example, is represented by normal trees in tropical Africa, but in *P. capense* (Fig. 9.2), a species of cooler South Africa, the stem, although of similar woodiness and ramification, is below soil level, only small shoots appearing at the surface. This so-called *suffrutescent* habit is also encountered, although less strikingly, in alpine willows.

In the development of the branch system the main axis may originate in two ways. Either the apical bud continues its vegetative growth indefinitely, or it is extinguished at the end of each season, when either it gives rise to a reproductive system of limited growth or it aborts. Where the apical bud remains active (Fig. 9.3a), the main axis is of simple origin, and growth is said to be *monopodial*. Where it is extinguished (Fig. 9.3b), growth is continued in the following season by the uppermost lateral. Subsequent positional re-adjustments often almost wholly obscure the discontinuities in the mature axis. The axis is, nevertheless, of compound origin, and growth is said to be *sympodial*. These two kinds of growth are represented amongst plants of all life forms. Amongst phanerophytes, for example, the growth

Table 9.1 | The relationship between life form and latitude.

Flora	Approx. latitude	Percentage representation				
		Ph	Ch	H	Cr	Th
Amazonian rain forest	0°	95	1	3	1	0
St. Thomas & St. John (Virgin Islands)	18°N	61	12	9	4	14
Denmark	57°N	7	3	50	22	18
Iceland	65°N	2	13	54	20	11
Spitzbergen	77°N	1	22	60	15	2

Notes:

Data from C. Raunkiaer, 1934. *The Life Forms of Plants*. Oxford University Press, London. Succulents, water plants, and specialized epiphytes are omitted.

Ph, phanerophyte; Ch, chamaephyte; H, hemicryptophyte; Cr, cryptophyte; Th, therophyte.

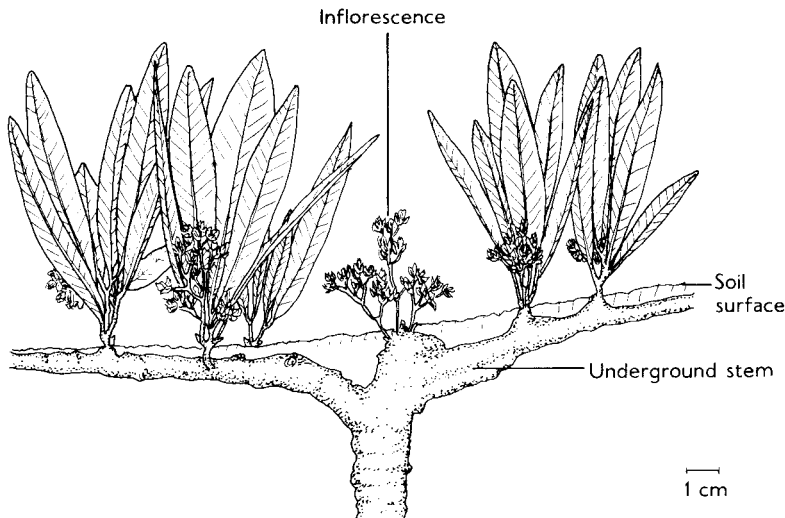

Figure 9.2 *Parinarium capense*.
The suffrutescent habit. (After Davy,
1922. *Journal of Ecology* 10.)

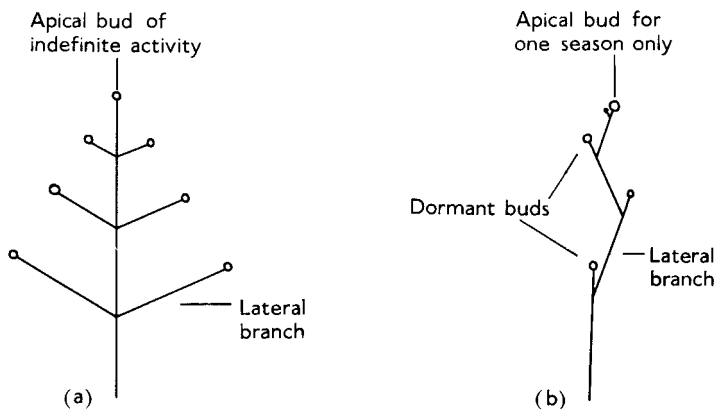

Figure 9.3 The basic types of
branching. (a) Monopodial. (b)
Sympodial.

of the ash (*Fraxinus*) is monopodial and that of the lime (*Tilia*) is sympodial. The factors which cause abortion of terminal buds in plants of sympodial growth are complex, but in trees day length is often of paramount importance. The shortening days of later summer and autumn stimulate the synthesis of a growth inhibitor in the leaves. This is in turn transmitted to the terminal buds, causing either dormancy or in some species abortion. In long days the inhibitor is lacking. Experimental alteration of day length can therefore sometimes lead to plants with sympodial growth becoming monopodial.

Aerial stems may sometimes twine in a regular fashion. Familiar examples are the hop (*Humulus lupulus*), where the stem grows with a left-handed screw (clockwise when viewed from above), and bindweed (*Convolvulus*), where the screw is right-handed. The mechanism by which twining growth is achieved remains obscure, but in the hop it has been demonstrated that the curvature of the stem remains the same whatever the diameter of the support. Consequently with increasing girth the coils become flatter. In some flowering plants the main axis takes the form of a horizontal rhizome, a form of growth already encountered in other groups of plants (e.g., p. 192). The rhizome of *Aegopodium podagraria* (goutweed), and probably of other species, is able, by adjusting the orientation of its growing region, to maintain itself at an almost constant depth beneath the surface of the soil. The physiological mechanism underlying this remarkable behavior is still not wholly known, but the ambient oxygen tension is probably an important factor. Other highly modified stems are seen in corms, bulbs and some tubers, in which the stem, which is adapted for the storage of food, either in itself (corms, Fig. 9.4a; stem tubers, Fig. 9.4b) or in the associated swollen leaf bases or scale leaves (bulbs, Fig. 9.4c), shows very little elongation. A very peculiar stem, resembling a thallose liverwort, is found in the Podostemaceae (Fig. 9.5), a family of small plants growing on rocks by tropical streams.

On tropical mountains at high altitudes (of the order of 4000 m (c. 13000 ft)), where the closed-canopy forest gives way to tussocky vegetation, familiar plant families may be represented by bizarre forms. The Asteraceae, for example,

contain the giant rosette plants *Espeletia* (of the South American paramo) and species of *Senecio* of similar form on African mountains. The large-leaved perennial rosettes are borne on woody stems, occasionally branched, and frequently shrouded by persistent dead leaves, the whole reaching or exceeding 2 m (7 ft) in height. These plants, scattered throughout largely herbaceous vegetation, presumably enjoy a selective advantage in the demanding environment at this altitude, but the operative factors have not been firmly identified. Species of *Lobelia* tend to adopt a similar, but less extreme, form on Mt. Kenya in Africa. Molecular comparison of the African high alpine species of *Senecio* with those of normal form at lower altitudes reveals no profound genomic differences.

Stems

GROWTH AND ANATOMY

The stem of the angiosperm grows from a group of meristematic cells lying near the summit of the apex. The apex itself (Fig. 9.6) is usually organized into two distinct zones, recognizable by their geometry and the directions of the divisions of the cells. In the center is the *corpus*, where divisions are in various directions, thus adding to the width of the apex as well as to its length. The corpus is covered by the *tunica*, a layer of cells in which divisions are principally anticlinal, thus increasing the surface of the apex. The tunica is usually two cells thick, but in some plants the thickness may amount to only a single cell and in others to four or five. That these two zones are to some extent independent is shown by the existence of chimeras in which the cells of the tunica acquire (as a consequence, for example, of treatment with colchicine) aneuploid or polyploid nuclei and retain them through all subsequent divisions, while the nuclei of the cells of the corpus remain diploid. The tunica yields the leaf primordia and ultimately the cortex of the mature stem, and the corpus the vascular tissue and associated parenchyma. Although this kind of apical organization is foreshadowed in the conifers (particularly in *Araucaria* (see p. 230)), it is nowhere so distinct as in the angiosperms.

In the Magnoliopsida, the primary vascular

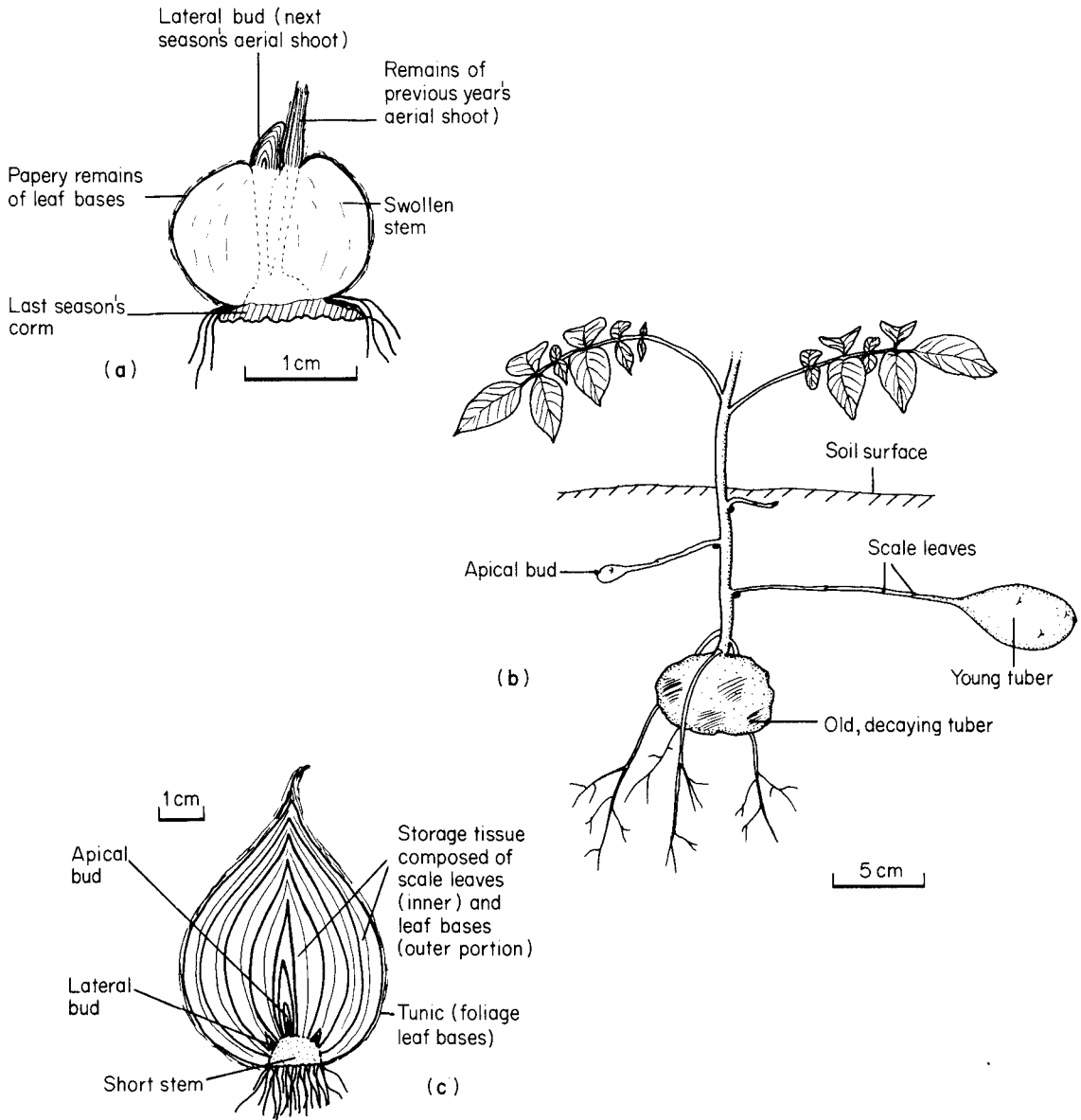

Figure 9.4 Stems modified for storage. (a) Longitudinal section of the corm of *Crocus* (winter condition). (b) Stem tuber formation in *Solanum tuberosum*. (c) Longitudinal section of the bulb of *Allium cepa*.

tissue usually consists of a ring of collateral bundles in which the differentiation of the xylem is centrifugal and of the phloem centripetal (Fig. 9.7). The xylem and phloem usually remain separated by a thin layer of undifferentiated cells, later recognizable as the intrafascicular cambium. In the Liliopsida, however, the bundles, although

often collateral and mostly oriented with the xylem adaxial, are not in one ring but are irregularly scattered in a parenchymatous matrix, referred to as the ground parenchyma (Fig. 9.8). The bundles of the Liliopsida also lack potentially meristematic tissue between the xylem and the phloem, and are consequently said to be “closed”.

Usually secondary vascular tissue soon appears in a magnoliopsid stem. The undifferentiated layer in the primary bundle becomes meristematic and continuous with a similar layer between the bundles (the interfascicular

Figure 9.5 *Butomia marginalis* of the Podostemaceae. Flowers are produced at the margin of the flattened stem. (After Taylor, 1953. *Bulletin of the British Museum (Natural History)*, Botany 1.)

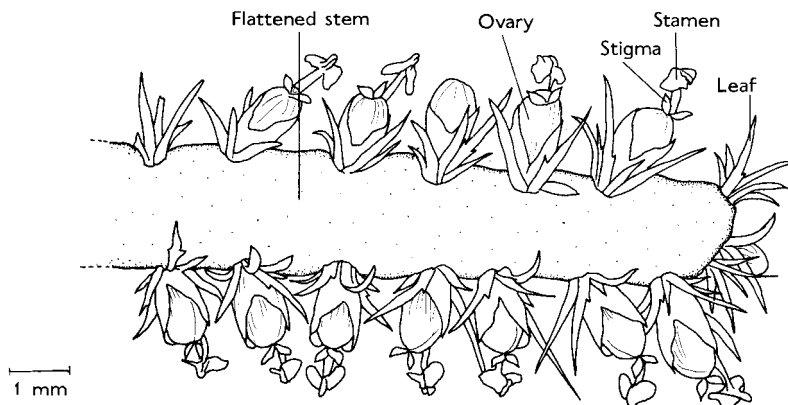
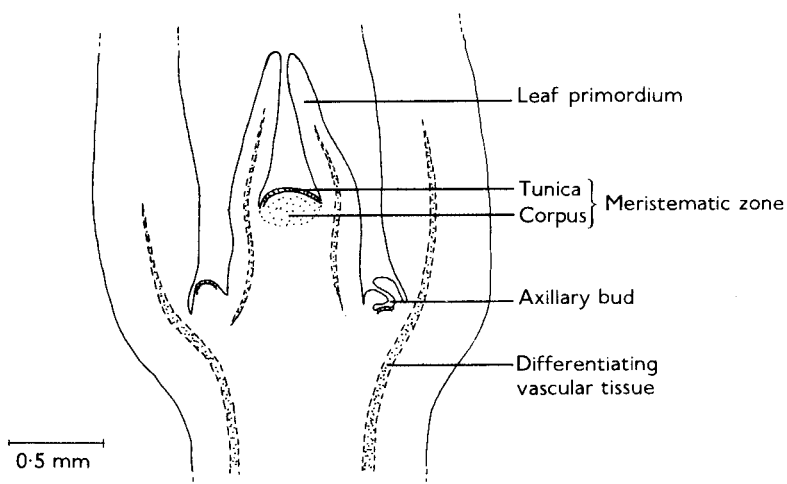

Figure 9.6 *Syringa*. Longitudinal section of the stem apex.



cambium), and subsequent activity of the cambial ring resembles that already seen in the gymnosperms (Fig. 9.9). The first cambium does not always continue to function indefinitely (notably in woody climbers, lianes). Other cambia then arise outside the vascular cylinder, recalling the situation in *Cycas* (p. 247).

In a few arborescent Liliopsida a meristematic zone at the periphery of the stem gives rise to additional collateral vascular bundles as the girth of the stem increases. This activity is, however, not extensive. In most arborescent Liliopsida, such as the palms, the plant remains for several years as a widening bud bearing a rosette of leaves only a little above soil level. When the bud approaches its mature diameter elongation of the stem takes place very rapidly. For this reason, coconut palms, for example, are not commonly seen with their trunks half extended. The manner of growth of the liliopsid trees is thus quite different from that of the magnoliopsid.

The vascular tissue of almost all angiosperms is distinguished from that of all but a few living gymnosperms (Gnetopsida, p. 259) by the presence of vessels in the xylem and of companion cells in the phloem. Vessels are long tubes, commonly about 10 cm (4 in.) long, but in some plants,

such as lianes, reaching or exceeding a length of 5 m (16.5 ft). These tubes are composed of segments (Fig. 9.10), each of which is derived from a single cell and is equivalent to a single tracheid. During differentiation of a vessel, however, the end walls of the segments are resorbed, leaving either mere rims marking their position, or highly perforated diaphragms, referred to as *end plates*. Vessels are often accompanied by tracheids. There are a few angiosperms (e.g., the largely southern hemisphere *Drimys*) in which the conducting elements of the xylem remain wholly tracheidal.

The sieve cells of the angiosperms are arranged in longitudinal rows, the whole column being referred to as a *sieve tube* (Fig. 9.11). The end walls of the sieve cells (or "sieve tube elements") are usually inclined and bear one or more sieve plates. The contents of the sieve cells remain organized, although the cytology is peculiar and the

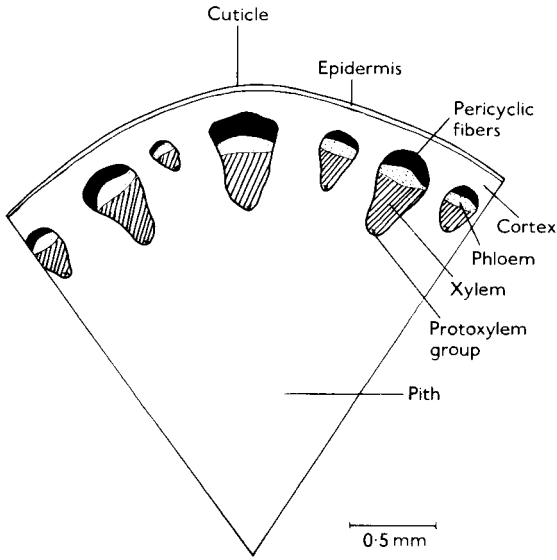

Figure 9.7 *Dahlia*. Transverse section of a segment of a young stem.

organelles, including the nucleus, are partly degenerate. Deposits of an amorphous polysaccharide, callose, often appear on the sieve plates at the end of the growing season. The companion cell or cells, closely applied to the sieve cell, may be essential for its function. The companion cell has a dense cytoplasm and a prominent nucleus; it arises from the same mother cell as the adjacent sieve cell. The sieve tubes of the liliopsid trees, in the absence of any significant cambial activity, necessarily remain alive and functional for many years.

The vascular system of the Magnoliopsida is evidently capable of maintaining a living plant body longer than that of the Liliopsida. ^{14}C data indicate that some trees in the Amazonian rain forest achieve ages in excess of 1400 years. Clumps of the creosote bush (*Larrea tridentata*) in the southwestern desert of North America have been estimated from growth measurements to be at least 10000 years old. Magnoliopsid trees may attain impressive heights. The Australian *Eucalyptus regnans*, for example, a tree of the temperate rain forest, reaches heights of 100 m (333 ft) or more, rivaling and perhaps exceeding the stature of conifers such as *Sequoia* and *Pseudotsuga*.

A cork cambium may arise in the outer cortex of the stem, particularly in Magnoliopsid trees. Any tissue outside it dies and forms a tough skin covering the first-formed cork. Aeration of the cortex is continued by way of lenticels, passages filled with powdery cork left in the denser and compact layered tissue.

In some Australian species of *Eucalyptus* dormant buds are retained deep within the tissues of the mature stem. These *epicormic* buds are often able to survive forest fire and restore growth to the affected area. A woody structure (*lignotuber*) is found at the base of the stem in many species of *Eucalyptus*. This is also well furnished with epicormic buds and can withstand fire. In the "snow gum" (*E. pauciflora*), which ascends to altitudes of 1400 m (4700 ft) in the Northern Tablelands of eastern Australia, the lignotuber is able to regenerate aerial growth in areas devastated by avalanches.

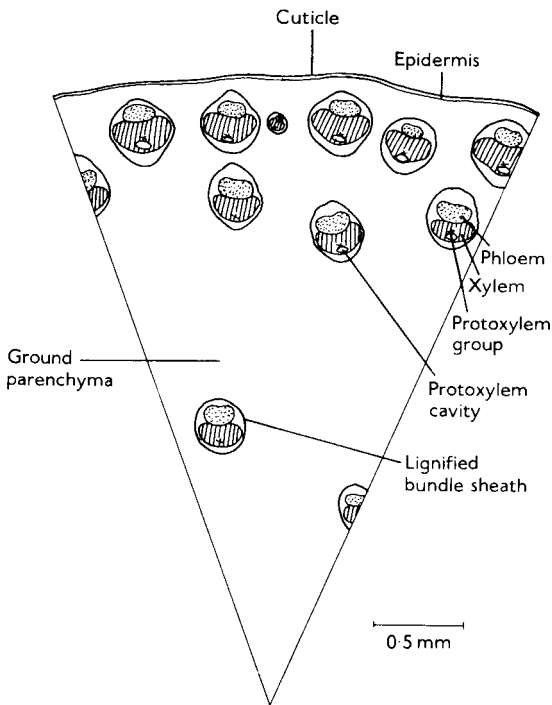

Figure 9.8 *Zea mays*. Transverse section of a segment of stem.

Figure 9.9 Diagram showing the method of production of secondary vascular tissue in a magnoliopsid stem.

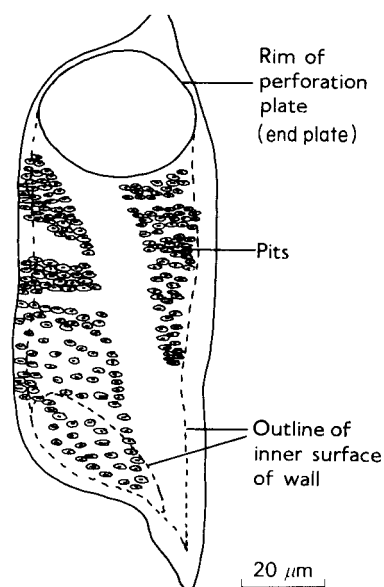
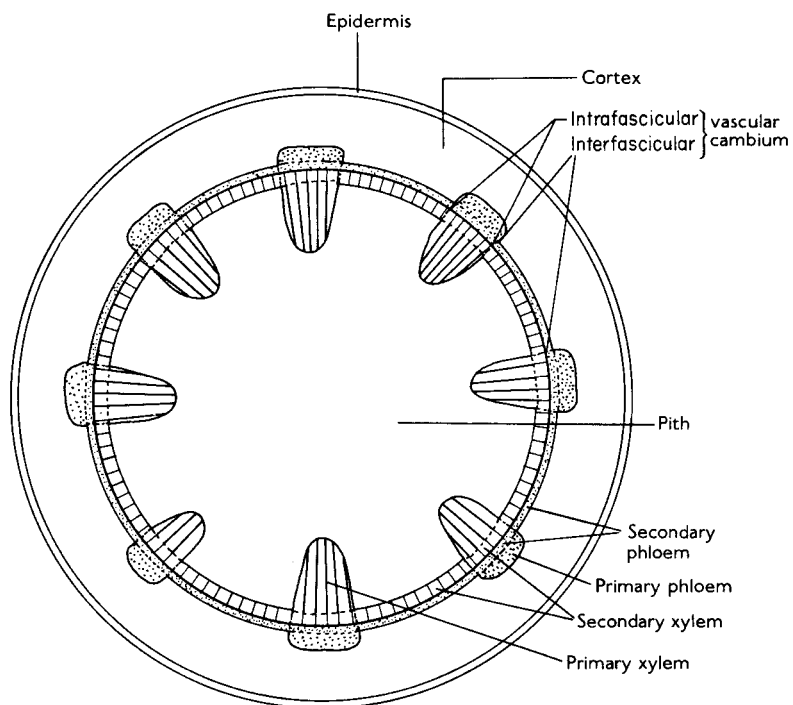

Figure 9.10 *Fraxinus*. A single vessel segment from a macerate of the secondary wood.

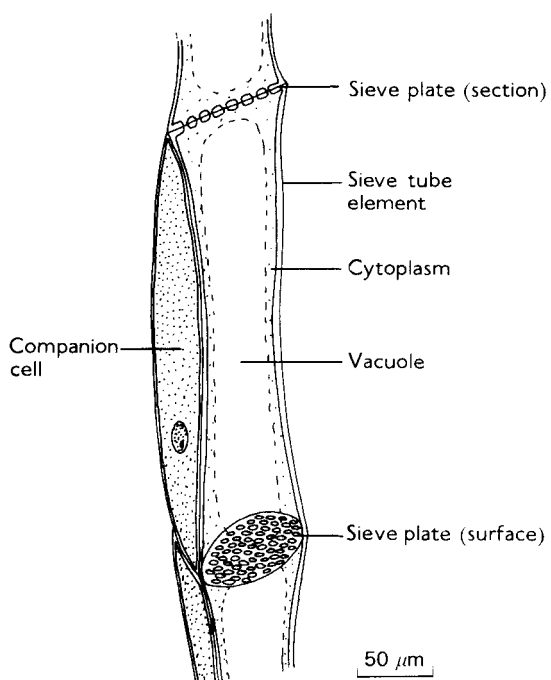

Figure 9.11 *Cucumis*. Longitudinal section of a sieve tube and companion cell.

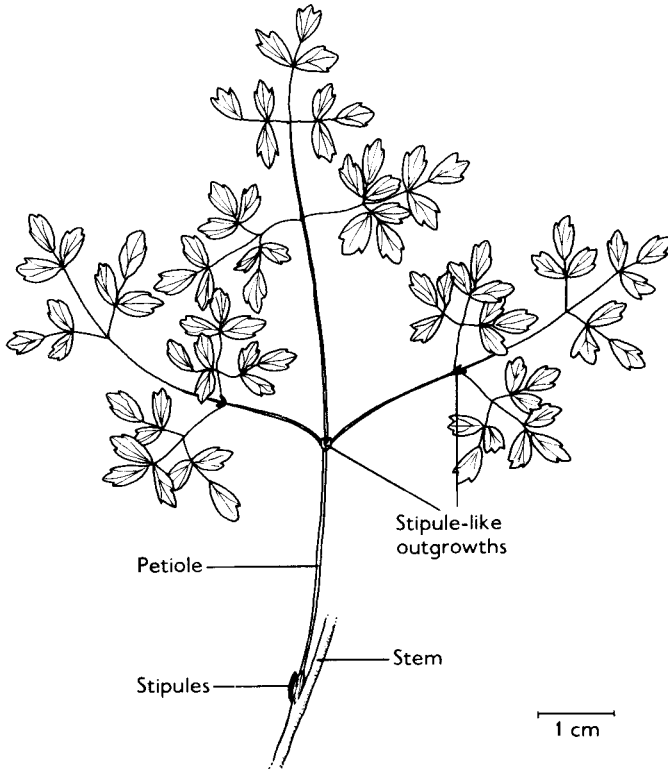

Figure 9.12 *Thalictum aquilegifolium*. Architecture of the compound leaf.

In many parts of the world wood is the principal source of fuel. Some woods (e.g., *Acacia*) contain rings of calcium oxalate crystals at the boundaries of the annual rings. These release carbon dioxide on burning, making for slow combustion. Such wood is much sought after by villagers in Zimbabwe.

Leaves

The leaves of angiosperms show a wide range of size and shape, and all forms of phyllotaxy from distichy to decussate, whorled and spiral arrangements are found. The factors determining these different arrangements have not

yet been identified. There are, however, theoretical grounds for believing that spiral arrangements (which, with upright stems, result in the minimum amount of shading of a leaf by others above it) are the consequence of a periodicity set up by interacting morphogens at the apex, and the resulting cell spacing. The actual emergence of the leaf primordium seems to be facilitated by the localized release of the wall-loosening protein extensin into the walls of the cells at the site of initiation.

In most mature leaves a petiole and lamina are usually distinguishable, and two small lateral outgrowths at the base of the petiole, termed *stipules*, are often present. In many species the leaves are pinnately branched, sometimes even as far as the third order, causing the whole to resemble a lateral branch system. This resemblance is occasionally enhanced (e.g., in *Thalictum aquilegifolium*, Fig. 9.12) by the presence of small outgrowths, recalling stipules, at the points of branching. At the other extreme leaves may be little more than scales, photosynthesis being carried out principally if not entirely in the stem.

ECONOMIC PRODUCTS

The stems of angiosperms frequently contain abundant fibers, and the formation of periderm in the outer cortex or even closer to the vascular tissue is often extensive. Some trees generate cork very freely, that of *Quercus suber* (cork oak) in the Mediterranean region and the Atlantic coast of Portugal being periodically harvested and finding many uses in commerce. A large part of the economic value of angiosperms in fact lies in the stems. Quite apart from the often very valuable timber, stems yield materials as diverse as starch (e.g., sago from the palm *Metroxylon* and arrowroot from the rhizome of South American *Maranta*), sugar (from sugar cane and in the form of syrup from the stem of *Acer saccharinum*, the sugar maple), fibers, spices (e.g., cinnamon, the bark of *Cinnamomum zeylanicum*), rubber (formed from the latex of *Hevea*, and less importantly from that of certain other species), oil (from the trunk of the Amazonian *Copaifera*), and drugs (e.g., quinine from the bark of *Cinchona*). The oil from *Copaifera* is rich in sesquiterpenes and resembles diesel fuel.

Figure 9.13 *Ruscus aculeatus*.
Habit of shoot.

In *Casuarina*, a tree of the tropics and subtropics of the Old World with leaves of this kind, the leaves are arranged in whorls so that the whole shoot comes to bear a striking external likeness to that of *Equisetum*. In a few plants (e.g., *Ruscus aculeatus*, butcher's broom) the reduction of the leaves to scarios scales has been accompanied by the transformation of lateral shoots of limited growth into flattened, leaf-like structures called *phyllodes* or *cladodes* (Fig. 9.13).

An intermediate condition is where photosynthesis is carried on in broadened and flattened petioles, the laminae being absent or rudimentary. These structures, called *phyllodes*, are found in many species of *Acacia* (wattle).

A classification has been developed for leaves, depending upon the area of the mature lamina, and clear relationships have emerged between climate and leaf size. In the tropical rain forest, for example, the leaves of many species tend to be large and of similar area, but in the dry, scrubby vegetation of the Mediterranean region the leaves by contrast show a much wider range of considerably smaller areas. Amongst other relationships, mostly of unknown significance, is the rarity of leaves with toothed margins in tropical vegetation, and their abundance in temperate vegetation. Leathery leaves, with their apices extended into "drip tips", are also characteristic of vegetation in regions of high rainfall. Experiments have shown that such leaves do drain faster than comparable leaves lacking such tips. Species growing by streams often tend to have long narrow leaves (*stenophylls*). Species of *Salix* (willow) provide familiar examples in north temperate regions.

Although the leaves of most species are differentiated into a lamina and a petiole, sometimes the petiole is lacking. The leaves are then termed

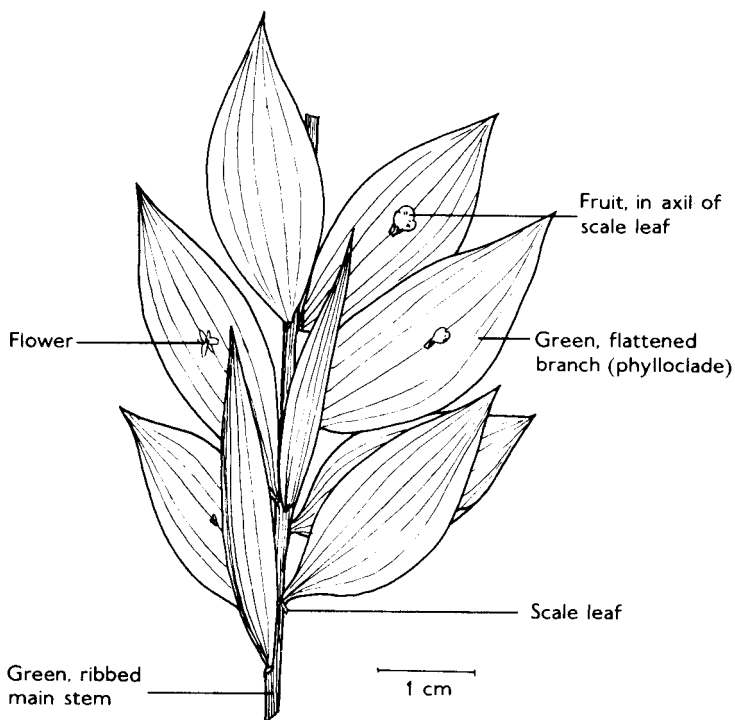

sessile. The grasses provide familiar examples of sessile leaves. Most leaves are oriented with the plane of the lamina more or less horizontal, and the insertion into the stem transverse. There are, however, some plants (all with distichous phyllotaxy) in which the plane of the leaf is vertical and the base of the leaf clasps the stem as a rider the horse. This so-called *equitant* arrangement is well seen in *Iris*. In some species motor cells, usually aggregated into a distinct pulvinus, are able to alter the orientation of the leaf in a striking fashion. In the tropical rain tree (*Samanea (Pithecolobium) saman*), for example, the leaves appear to collapse with the diminishing light of the afternoon (a so-called "sleep movement"), and in *Mimosa pudica* (sensitive plant) similar movements take place if the leaves are mechanically disturbed. The leaves of the "compass plants", of which *Lactuca scariola* (a wild lettuce) is a notable example, move in relation to the sun so that only one edge is fully insolated at any one time. The motive effects of pulvini depend upon changes in turgor and the ability of the cytoplasm in certain conditions to move water actively in and out of vacuoles.

In many Liliopsida the leaf bases become

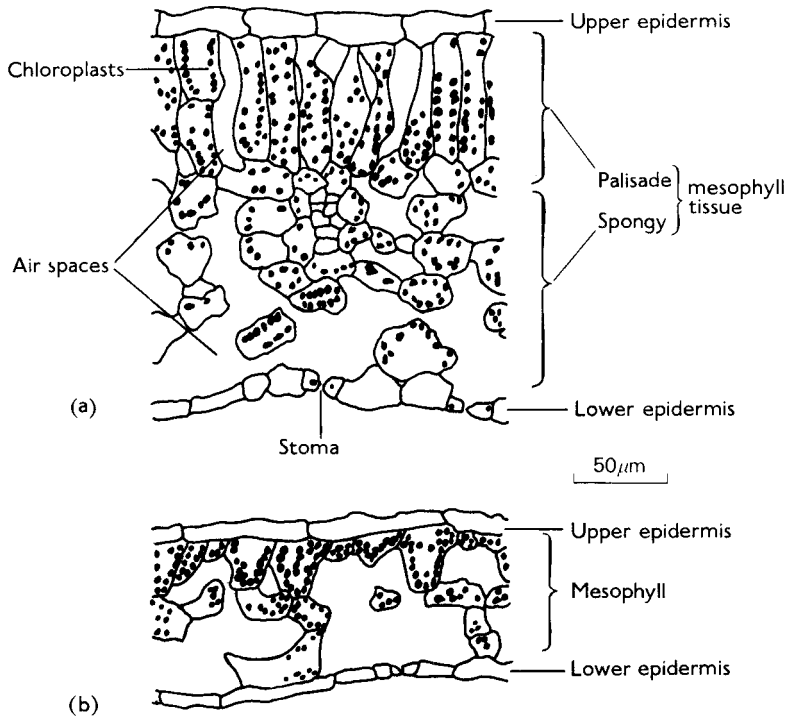

Figure 9.14 *Impatiens parviflora*. Transverse section of leaf. (a) From plant growing in full sunlight. (b) From plant growing in 7 percent sunlight. (After Hughes. 1959. *Journal of the Linnean Society, Botany* 56.)

Amongst other structures found in leaves are oil glands, often giving the leaf a fragrance when crushed, and, usually at the margins or on the petiole, nectaries (as, for example, in *Prunus*, cherry). In some species of tropical plants stipular nectaries are associated with symbiotic bacteria ("leaf nodules"). The venation of the lamina of the magnoliopsids is commonly reticulate, patterns of extreme intricacy often being generated by the

swollen and form a subterranean bulb which overwinters (Fig. 9.4c). The cells of the bulb are filled with food reserves, and are often also rich in secondary metabolites. The lachrymatory thiopropanol S-oxide of the onion bulb is particularly well known. In palms the leaf base is often prominent and continues to ensheath the trunk long after the expanded portion of the leaf has died and fallen. The result is a shaggy-looking trunk, often "tidied up" when palms are used as street trees.

ANATOMY AND DEVELOPMENT

Although the leaves of angiosperms are structurally similar to those of gymnosperms, there are a number of new features. The palisade tissue, for example, is frequently sharply differentiated from the rest of the mesophyll and in some plants, especially in those that are shade tolerant (e.g., *Impatiens parviflora*, balsam), the form of the palisade is markedly influenced by the irradiance (Fig. 9.14). The change in cell shape in the shade exposes a greater proportion of the chloroplasts to the incident light with the result that over a wide range there is little variation in net assimilation. Equitant leaves are usually bifacial, stomata and palisade being symmetrically placed on each side.

minor veins, many of which end blindly in the areolae (Fig. 9.15). The symmetry of the vascular supply ascending the petiole is usually clearly dorsoventral, but it becomes almost perfectly radial in the petioles of peltate leaves (e.g., *Tropaeolum majus*, the garden nasturtium).

The leaf primordium grows from initial cells at its margin, and at first cell division predominates over expansion. The pattern of the main veins soon, however, becomes established, and also, in Magnoliopsida, that of any branching of the leaf. This is brought about by the marginal meristem becoming discontinuous and its activity confined to definite areas of the periphery. Segmentation in the leaves of liliopsids (e.g., palms) is a more complicated process, involving folding and the elimination of tracts of tissue between areas which subsequently become pinnae.

As growth of a leaf primordium proceeds, cell expansion comes to predominate over division, one of the last products of cell division being the guard cells of the stomata. It is evident that the surface growth of the lamina is closely coordinated with the extent of the vascular framework. In some plants it is possible to disturb this

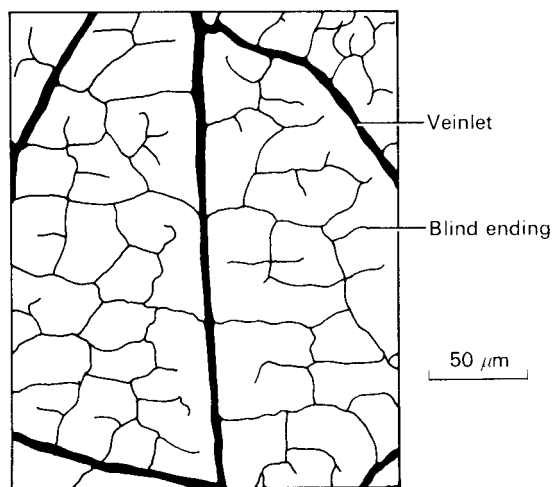

Figure 9.15 *Impatiens parviflora*. The pattern of leaf venation. (After Hughes. 1959. *Journal of the Linnean Society, Botany* 56.)

coordination by allowing the primordium to form in one day length but to expand in another, leading to deformed leaves. These experiments reveal that the factors controlling the growth of the vascular skeleton are different from those influencing the expansion of the lamina. Standing apart from this general scheme of development are again the leaves of some Liliopsida. The leaf of a grass, for example, grows from a meristem at the base of the lamina, above which there is continuous basipetal differentiation until the leaf reaches its mature length.

In some species leaves are deciduous, being severed from the axis by a distinct abscission layer. Partial digestion and disarticulation of cell walls at this site are brought about by hydrolases, including cellulase. In temperate regions abscission usually occurs during the shortening days of autumn, but some tropical trees also regularly shed their leaves, the periodicity having no evident relation to season.

Leaves of angiosperms show a wider range of surface coverings than those of any other land plants. These may take the form of plates or crystals of wax (as on the upper surface of the leaf of *Zea mays*) or of hairs or scales. Markedly pubescent leaves are often found in desert plants, and such investments may reduce the absorbance of photosynthetically active light by as much as 60

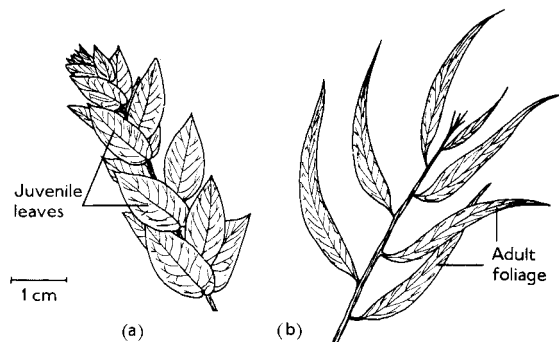

Figure 9.16 *Eucalyptus globulus*. (a) Shoot with juvenile leaves. (b) Shoot with adult leaves. (After Niedenzu, in Engler and Prantl. 1898. *Die Natürlichen Pflanzenfamilien*, vol. III, 7. Engelmann, Leipzig.)

percent. There is evidence that this is an adaptive response, the degree of hairiness being such that net assimilation is matched to the water available.

The vascular bundles in leaves are frequently surrounded by a chlorophyllous sheath. In some plants this sheath consists of a single layer of large cells containing conspicuous chloroplasts. These can be seen in the light microscope to lack grana, but starch grains are often prominent. This so-called "Kranz" anatomy is associated with a particular kind of photosynthesis in which carbon dioxide is taken first into phosphoenolpyruvate instead of directly into the ribulose biphosphate of the Calvin cycle (p. 6).

JUVENILE AND MATURE FORMS

As in the conifers, the leaves of young plants sometimes differ from those of the mature in both form and arrangement. *Eucalyptus globulus* (Fig. 9.16) provides a striking example of this phenomenon. The juvenile leaves are ovate, decussately inserted, and bifacial in structure, whereas the mature are falcate, spirally inserted and possess normal dorsiventral structure. A young tree has a cone of juvenile foliage within a crown of mature foliage, showing that the change takes place more or less simultaneously at all the apices when a tree reaches a certain maturity. Sometimes, as in *Hedera helix* (ivy), mature foliage does not appear until the approach of reproduction. Once the production of mature foliage has begun, the system is remarkably stable. Reproductive branches of *Hedera*, for example, can be struck as cuttings, and

these yield small bushes quite different in appearance and growth from the scandent vegetative plant. The flora of New Zealand is remarkable for the number of woody plants in which the juvenile and mature leaves have a very different form. It is often difficult, even by experimental means, to cause the apices of mature plants to revert to juvenile growth. It appears likely that maturity is a consequence of complex and coordinated changes in the ribonucleic acids and proteins in the meristematic cells, and that the original system is only readily re-created during sexual reproduction.

ECONOMIC AND ECOLOGICAL IMPORTANCE
Angiospermous leaves are a rich source of foodstuffs and raw materials. Fodder crops often consist largely of leaves, and the leaves of many species are prized as pot herbs because of the aromatic oils they contain. The leaves of a wide range of species find medicinal uses, and they are the commercial source of a number of important drugs, amongst them atropine and hyoscyamine (from *Atropa* and other members of the Solanaceae) and cocaine (from *Erythroxylon*). The hallucinogens of *Cannabis* accumulate within the resinous secretions of the leaves, particularly the bracts of the female inflorescence. The amount produced depends upon temperature, and in cool temperate regions is trifling. The biosynthetic capacity of leaves can be diverted by genetic manipulation into unusual products. Genes from the bacterium *Alcaligenes*, responsible for the synthesis of polyhydroxybutyrate (PHB), a normal reserve product in this organism, when transferred to the plastid genome of *Arabidopsis* continue to be expressed. Up to 14 percent of the dry mass of the transgenic plant may consist of pure PHB. PHB is used in commerce for the preparation of biodegradable household plastics. The biosynthetic capacities of transgenic *Arabidopsis* (and possibly other plants) may provide a cheaper and more environmentally acceptable source of the raw material than the chemical industry.

The leaves of many monocotyledonous species yield valuable fibers, and in tropical regions palm leaves provide a ready and efficient material for thatching. The sheathing leaf bases of the Amazonian palm *Leopoldinia* yield commercial quantities of a valuable fiber (piassava). The fiber

can be readily twisted into cords and ropes. Hawsers made from piassava are a familiar sight on the lower Amazon; they have the advantages of lightness and a reluctance to sink.

Apart from such direct utilization, angiospermous leaves play a large part in maintaining the fertility of the soil. Since they contain a higher proportion of nitrogenous substances and fewer antiseptic materials, such as tannins and phlobaphene, the leaves of angiosperms decay more rapidly than those of gymnosperms. Angiospermous litter is thus quickly reduced to humus, the organic matter that is the basis of soil fertility. The productivity of much natural vegetation in tropical regions depends upon the steady deposition of litter. Thoughtless removal of this natural cover and destruction of the ecosystem can result in areas of persistent and intractable barrenness.

Roots

The roots of the angiosperms are in general organized similarly to those of the gymnosperms. Those of some species are able to develop chlorophyll when illuminated. In *Taeniophyllum* (Fig. 9.17), a peculiar Malaysian epiphytic orchid, photosynthesis is in fact confined to band-like aerial roots, the stem remaining little more than a bud until the production of the inflorescence. A number of angiosperms, especially those of temperate regions that are biennial in habit, develop a swollen tap root which overwinters. These are often used as vegetables, carrots and parsnips being familiar examples. The swollen part of the radish is the transitional region between root and stem.

Remarkable development of roots is characteristic of a number of tropical plants. In some trees the secondary thickening of the principal roots at the base of the trunk is markedly asymmetrical, leading to the formation of substantial buttresses 1 m (39 in.) or more in height. Some trees develop "prop roots". These leave the trunk at 1 m (39 in.) or more above ground level and descend obliquely toward the substratum. They soon become secondarily thickened. At maturity the tree is supported by a cone of such outgrowths around its base. Some species of fig (*Ficus*) germinate in humus lodged in the branches of other trees. They then send down branching roots which closely

Figure 9.17 *Taeniophyllum* sp.
Habit showing flattened,
photosynthetic roots. (After Goebel
1933. *Organographie der Pflanzen*.
Fischer, Jena.)

invest and ultimately kill the supporting species (“stranglers”). Roots are not always negatively gravitropic. A number of trees of the Amazonian rain forest, for example, produce auxiliary roots which ascend the trunks of neighboring trees. These probably absorb minerals from the water trickling down from the canopy and augment the poor supply available from the soil. Swamp plants, notably the mangroves (which colonize brackish estuaries in the tropics), often produce negatively gravitropic aerenchyma roots from the root system, a development foreshadowed in the pinopsid *Taxodium* (see p. 230). The roots produced by the aerial stems of climbers (e.g., *Hedera* (ivy) and *Campsis* (trumpet vine)) are often of limited growth and modified in a manner which assists adhesion.

Associations between roots and microorganisms are not infrequent. In forest trees the upper rootlets, usually found proliferating in litter, often possess mycorrhizal fungi. The roots of orchids are also mycorrhizal, but it has been discovered that these plants, which are all herbaceous, can be grown in pure culture in the absence of the fungus, provided suitable nitrogenous substances are supplied in the medium. In the Fabaceae (the family containing the peas, beans and several important fodder plants) there is a regular association, involving anatomical modifications, between the roots and certain soil bacteria capable of fixing atmospheric nitrogen. Similar associations with other nitrogen-fixing microorganisms have been confirmed in *Alnus*

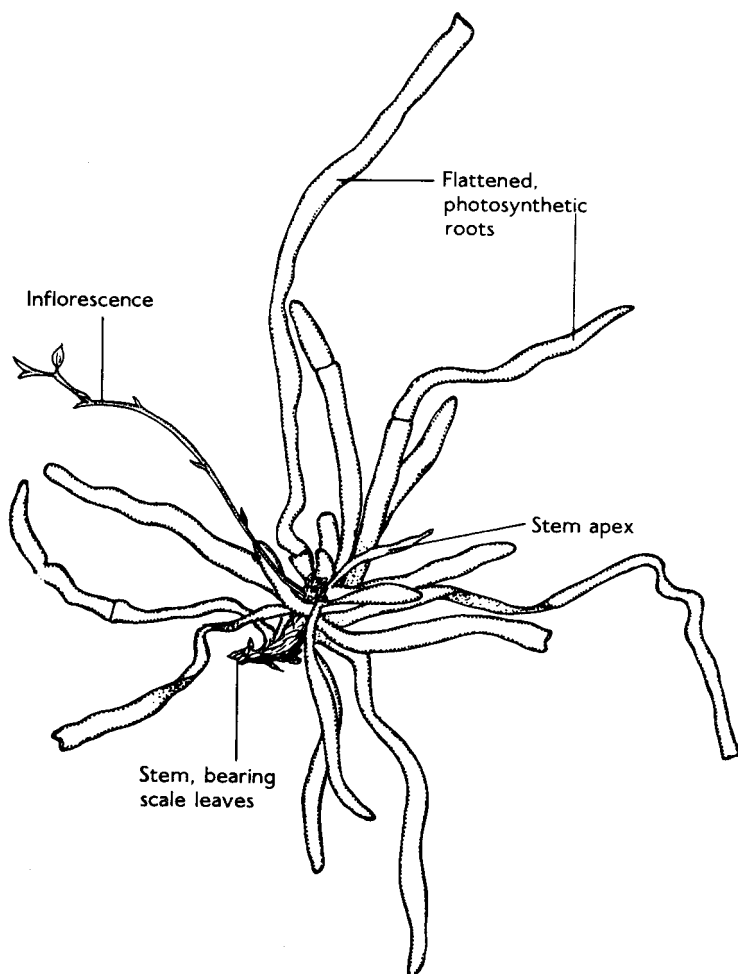

(alder), *Hippophaë* (sea buckthorn), *Myrica* (bog myrtle) and *Ceanothus* (Californian lilac), and probably exist in a number of other plants.

The manner of growth of roots of angiosperms has been studied in some detail, since it is not complicated by the presence of leaf primordia. Apart from the root cap, which is maintained by a meristem adjacent to the surface of the apex proper, meristematic activity lies principally in the summit of the apex (Fig. 9.18). There is, however, convincing evidence, supported by experiments with radioactive isotopes, that a group of cells at the center of the apex experiences few if any divisions. These cells, forming a so-called “quiescent center”, can be stimulated into division by wounding and radiation damage, so they are not deficient in essentials. Their normal inactivity must therefore depend upon

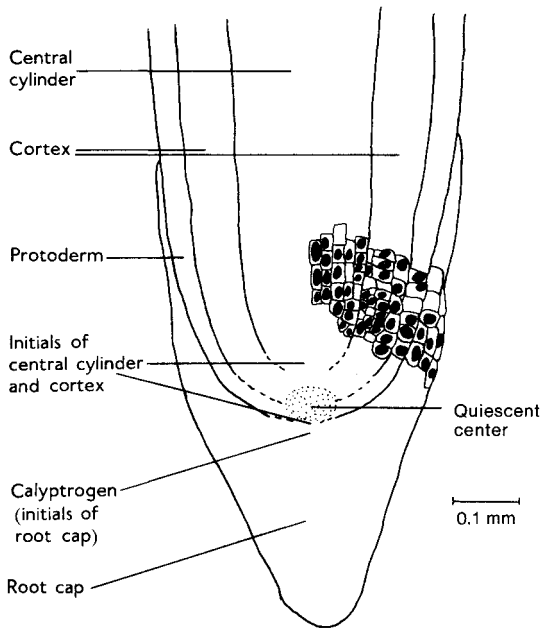

Figure 9.18 *Trillium* sp. Longitudinal section of root apex.

the physiological organization of the intact apex, but the precise factors involved are still unknown. Behind the meristematic area the cells elongate, and measurements have shown that there is considerable synthesis of ribonucleic acid and protein in the cells concerned at this time. In some cells, often those which produce root hairs, the nuclei undergo a curious form of mitosis without associated division (endomitosis), leading to a polyploid condition.

The roots of some plants secrete substantial quantities of substances interfering with the growth of adjacent species (allelopathy). The perennial weed *Pluchea lanceolata* (Asteraceae), for example, a pest in semi-arid regions in India, liberates a range of phenolics into the soil. These seriously depress the yield of crop plants and contaminate local ground water.

A transverse section of a young root of an angiosperm commonly shows a central core of xylem with radiating arms of protoxylem, between which lies the phloem. In the magnoliopsids the number of protoxylem groups is usually small (Fig. 9.19), but in the liliopsids often greater, usually in the region of 15 or 20. An endodermis, separated from the vascular tissue by a zone of

parenchyma (pericycle), is usually present. The root is the only region in the plant body of an angiosperm where an endodermis occurs with any regularity. The presence of the lipoidal Casparian strip in the radial walls may ensure the ordered uptake of mineral nutrients by subjecting the lateral movement of the dissolved salts to the control of the symplast.

The meristems of branch roots arise in the pericycle, an origin termed *endogenous*, and very different from the more superficial (*exogenous*) origin of branches of the stem. Where cork is produced, the cork cambium arises in the pericycle, thus causing the whole of the primary tissue external to it ultimately to die and slough off. In herbaceous plants the parenchymatous tissues of the roots sometimes become locally distended with food materials, occasionally forming distinct tubers (e.g., *Dahlia*, Fig. 9.20). These serve as organs of perennation.

Roots, especially those that are tuberous, are frequent sources of drugs and folk medicines. Aconitine, obtained from the roots of *Aconitum napellus*, frequent in alpine meadows and seen occasionally by shaded streams in Britain, is a well-known example. Derris, a powder made by grinding the roots of *Derris elliptica*, a climbing shrub of Asia, is a powerful insecticide harmless to people.

Correlation within the plant body

The angiosperms, more than any other division of the plant kingdom, have been investigated with the object of discovering the factors responsible for coordinating the growth of the plant as a whole. In the presence of an apical bud, for example, lateral buds commonly remain inactive, an instance of *correlative inhibition*. Correlations of this kind are clearly of great importance in determining the morphology of the mature plant.

Correlation is a consequence of cell interaction, but the interacting cells are often separated by others not directly concerned. These interactions at a distance are brought about by growth-regulating substances (often termed "plant hormones" or "phytohormones") which move through the plant in a manner not yet wholly understood. Research has now revealed a whole series of such substances, which for present

Figure 9.19 *Ranunculus acris*.

Transverse section of young root, showing the broad cortex and narrow stele. The protoxylem is exarch. Differentiation proceeds inward yielding a central core of metaxylem. The phloem lies between the arms of xylem.

purposes can be classified as auxins, kinins, abscisins, gibberellins and ethylene. Auxins (of which indole-3-acetic acid (IAA) is the most familiar) are those substances which will cause curvature if supplied asymmetrically to the tip of a decapitated oat coleoptile. They are usually produced by meristematic cells and are involved (amongst other effects) in maintaining apical dominance and initiating differentiation. In culture solutions IAA (and its non-metabolizable analog naphthalene acetic acid) are particularly effective in stimulating the production of roots, a property made use of in horticulture in the rooting of cuttings. Kinins (cytokinins, phyto-kinins) are substances which promote cell division. They are found in fruits and seeds, but may also be generated in damaged cells and cause proliferation around wounds and their subsequent repair. Abscisins (abscisic acid), probably produced in leaves, are effective in causing leaf abscission, and dormancy in apical buds, common phenomena in trees of temperate regions. In addition, they probably enter into many other correlative mechanisms. Gibberellins were first extracted from the fungus *Gibberella* which, when infecting rice, causes the plant to be excessively tall. They are now known to exist in higher plants. Early experiments showed that when administered to dwarf mutants as, for example, of maize (corn), these would grow to their normal stature. Evidence now points to their being also involved in photoperiodic responses and the change from vegetative to reproductive growth. Ethylene has long been known to be produced by ripening fruits, and conversely the process of ripening in stored imma-

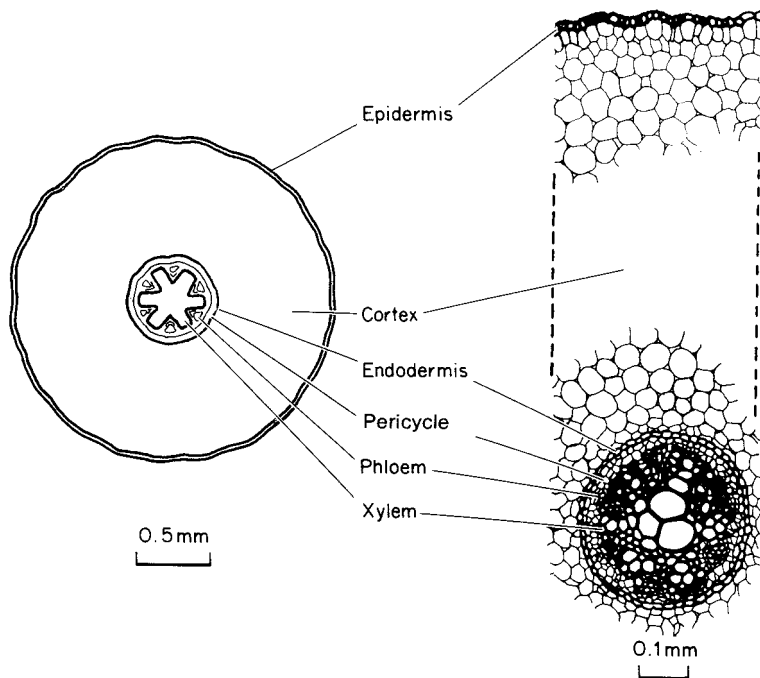

ture fruits can be controlled by regulation of the amount of ethylene in the atmosphere. Ethylene also produces many other effects, probably as a result of interacting with IAA within the plant. Many other naturally occurring substances, amongst them salicylic acid and jasmonic acid, have been found to affect cell growth and behavior. Even steroid hormones (brassinosteroids) have been discovered in plants, and in *Arabidopsis*, and probably more generally, play an important rôle in light-regulated development. The morphogenetic effects of sugar fragments (they are involved, for example, in the changes in composition and form of cell walls which occur as a consequence of fungal infection) are another factor which has to be taken into account in the control of growth and development.

Although detailed investigation of the growth-regulating substances is the province of the plant physiologist, these substances are also basic to the causal study of morphology. Regulatory substances are ultimately responsible for directing the growth of a species in its characteristic and immediately recognizable way. It was inevitable that the flowering plants, because of their ubiquity, familiarity and economic importance, should figure prominently in research into

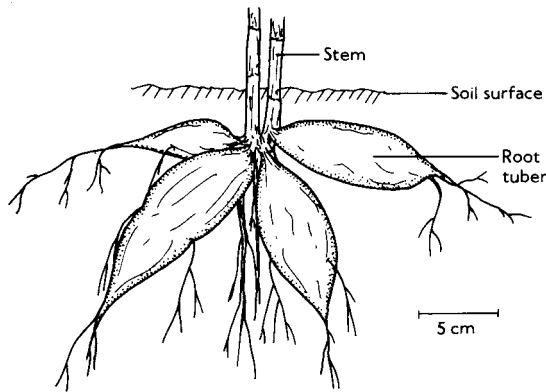

Figure 9.20 *Dahlia* sp. The production of root tubers.

growth-regulating substances. Nevertheless, the study of simpler systems in the archegoniate plants, and possibly in the algae, might more readily reveal how these substances enter into the molecular biology of the cell and influence morphogenesis.

Sexual reproduction

In the angiosperms the onset of the reproductive phase is frequently (but not always) dependent on the length of day (“photoperiodism”), both short-day and long-day plants being clearly recognizable. The reproductive axes are ordinarily short and of limited growth. The axis itself and its attendant structures, which are often conspicuously colored or shaped, is termed a flower. Flowers may be borne either singly (as in *Anemone nemorosa*) or severally, the branching system bearing the flowers then being called an *inflorescence*. Inflorescences may have complex morphology. Sometimes the inflorescence is contracted and superficially resembles a single flower (as in many Asteraceae). Inflorescences may also take the form of loose strobili (as the catkins of *Populus*, poplar) or (especially in fruit) a coniferous cone (as in *Alnus* of the northern hemisphere and *Banksia* of the southern). The parts of a plant giving rise to flowers or inflorescences are not normally very different from those that are vegetative, but distinct functional separation occurs in some tropical trees. In *Couroupita guianensis* (cannonball tree), for example, the uppermost branches are densely leafy and solely vegetative. The reproductive branches, which are almost leafless and bear

numerous flowers, arise directly from the trunk and hang down from the crown. In some other tropical trees, flowers are produced only from special regions toward the lower part of the trunk (as in the jack fruit, *Artocarpus*, of tropical gardens), a phenomenon known as *cauliflory*.

In annuals and certain longer-lived plants of warmer regions the production of flowers heralds the end of the life span. Such plants are said to be *monocarpic* or *hapaxanthic*. A spectacular example is the palm *Corypha* of tropical Asia. Growth terminates with the production of an inflorescence reaching a height of 14 m (46 ft) and a breadth of 12 m (40 ft), containing more than 100 000 flowers.

Reproduction in angiosperms may be either monoecious or dioecious. Monoecious species are further divisible into the monoclinal, where the male and female organs are together in the same flower, and the diclinous, where they are in separate flowers (as in the cucumber, *Cucumis sativus*). Functional separation of the sexes in bisexual flowers is often achieved by the organs of the two sexes maturing at different times, a phenomenon termed *protandry* if the male precede the female, and *protogyny* if the female precede the male. Some orchids show an extreme form of protandry in which the ovules are not formed unless the flower is pollinated. In some species self-pollination is discouraged or prevented by the flowers being in two (as in *Primula*) or even three (as in *Lythrum*) forms (see p. 296).

MALE REPRODUCTIVE STRUCTURES

The male sporangiophore of the angiosperms is termed a stamen (Fig. 9.21). Typically this consists of a stalk (*filament*) terminating in four pollen sacs, the sacs being in two pairs, the pairs lying side by side and joined by the *connective*. The whole of this region is called the anther, and seen in transverse section (Fig. 9.22) resembles the male synangia of some extinct pteridosperms, and *Caytonia* (Fig. 8.48). Apart from congenital fusion of stamens, discussed later, there is some variation in the form of the individual sporangiophore. In *Degeneria*, for example, and in some members of the Magnoliaceae, the “filament” is in fact a broadly ovate scale, about 5 mm (0.19 in.) long and 2 mm (0.08 in.) wide, with four pollen sacs partially embedded on the adaxial surface (Fig. 9.23).

Figure 9.21 Diagram showing the features of a typical angiosperm stamen. (a) Viewed from the front. (b) Viewed from the back. In this anther the pollen sacs open toward the floral axis (introrse), but the reverse position is also found (extrorse).

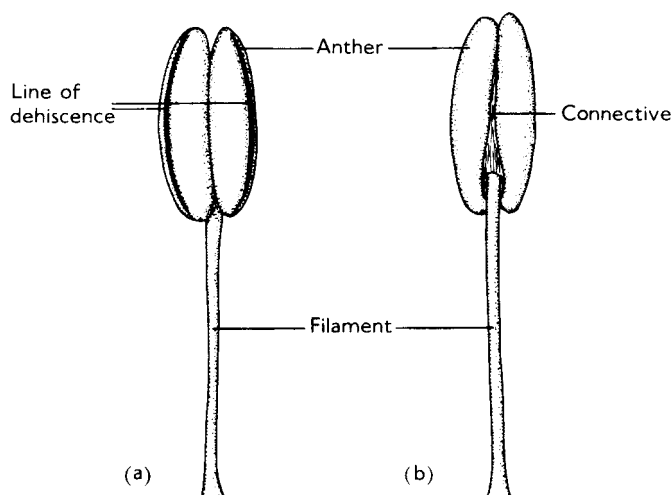
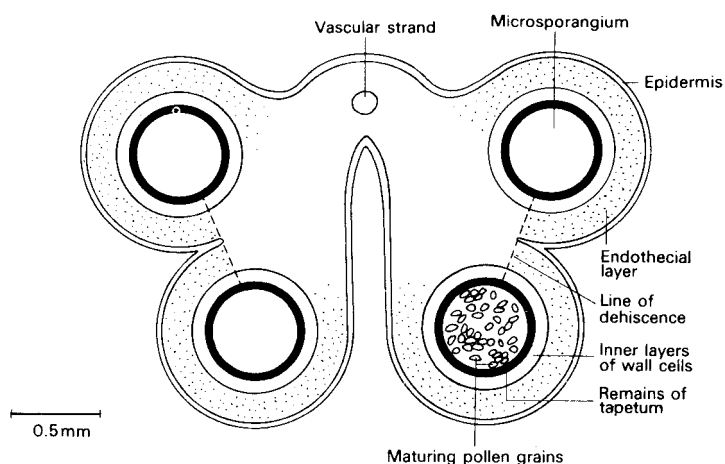

Figure 9.22 *Lilium longiflorum*. Transverse section of almost mature anther.

At the other extreme the filament may be lacking, one or two anthers being attached directly to a modified floral axis, as in the complex flower of the orchids. Besides simple dehiscence along a longitudinal stomium, other methods of opening, such as the development of pores or the differentiation of distinct valves, are encountered in some species.

In contrast to microsporogenesis in *Pinus*, the development of angiospermous anthers is commonly synchronous. This is probably a consequence of broad cytoplasmic connections between the young spore mother cells, a phenomenon (*cytomixis*) not seen in *Pinus*. Subsequently the pollen mother cells become surrounded by thickened callosic walls and all interconnections are obliterated. After meiosis the young microspores, while still in the tetrad, begin to be coated with sporopollenin. Concurrently, cellular organization breaks down in the tapetum, metabolites are mobilized by hydrolase activity, and additional sporopollenin is synthesized. The young pollen grains are released into this medium and complete their development at its expense (Fig. 9.24). Much of the tapetal sporopollenin is added



to that already coating the grain, probably by simple accretion. The pattern of deposition and location of the pores (colpi) are established before the grain is liberated from the tetrad. The Liliopsida and the Magnoliidae (p. 303) both have pollen with a single aperture (monocolpate), but pollen of the rest of the Magnoliopsida usually has three apertures (tricolpate). The manner of the inheritance of the pattern of wall thickening (which is very distinctive (Fig. 9.25), allowing identification of isolated grains) and the location of the pores are still unknown (cf. *Sphaerocarpos*, p. 114). The structure and cytochemistry of the wall of a mature pollen grain are complex. The chambered exine often takes up enzymes and other proteins from the tapetum while the inner cellulosic layer (intine) may contain secretions from the grain itself. Although the tapetal products are

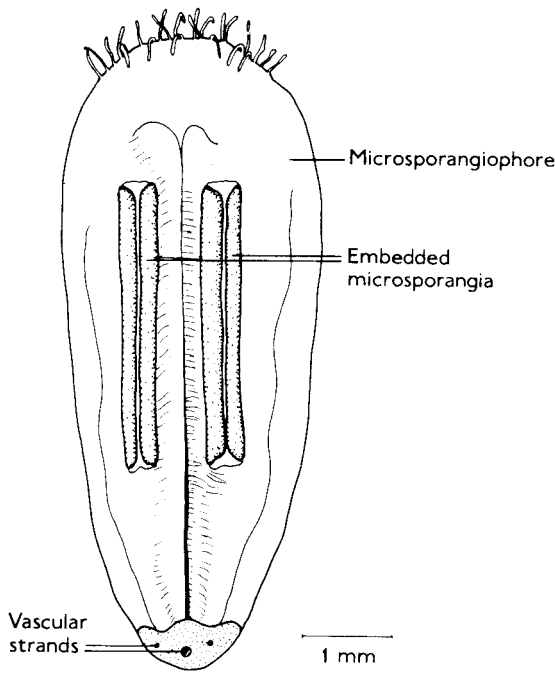

Figure 9.23 *Degeneria vitiensis*. Adaxial surface of stamen. (After Canright, 1952. *American Journal of Botany* 39.)

commonly regarded as sporophytic, and those of the grain gametophytic, the precise nature of the gene activation in the tapetum is not yet certain. In some species part of the tapetal sporopollenin coats an additional membrane delimiting the sac containing the developing microspores (*peritapetal membrane*). The formation of this barrier may be associated with a change in the nature of the gene expression within the sac.

Since sporopollenin, a highly polymerized mixture of esters of complex fatty and cinnamic acids, is extremely resistant to decay, the external features of pollen grains partially fossilized in peats and lake muds are often well preserved. These deposits provide accurate information about the nature and composition of the surrounding vegetation in times past (*pollen analysis*). The pollen grains of plants of terrestrial habitats are mostly spherical or ellipsoidal, with varying diameters, those of some plants (e.g., *Mirabilis*) reaching as much as 130 μm , but this is unusual. There are a few examples of rod-like grains. A quite remarkable cylindrical grain is found in *Crossandra* (Acanthaceae), attaining a length of

520 μm and diameter of 19 μm . Marine angiosperms ("sea grasses"), however, possess "confervoid" pollen. These grains lack exine and may reach or exceed 5 mm (0.19 in.) in length. In some species (as in the Ericaceae (heaths) and the decorative plant *Salpiglossis variabilis*) the pollen remains stuck together in tetrads, a feature facilitating, as in *Sphaerocarpos* (p. 114), tetrad analysis. Even larger aggregates of pollen (known as "polyads") occur naturally in some genera. Those of *Parkia*, for example, contain 16–32 grains and are not separated by acetolysis (which destroys all structural materials other than sporopollenin). In *Petunia*, where the grains are normally separate, adhesion within the tetrads can be brought about by a recessive gene.

Development of the male gametophyte normally begins while the pollen is still in the anther. Usually two nuclei are present, of which one (the vegetative nucleus) becomes large and diffusely staining and the other (the generative nucleus) dense and often transversely elongated (Fig. 9.32a). These nuclei lie on a radius of the original tetrad, and there is evidence that their conspicuously different behavior depends upon gradients set up in the cytoplasm of the cleaving pollen mother cell and persisting in that of the grain. In about one-third of all families (both liliopsids, including the grasses, and magnoliopsids) the generative nucleus divides while still in the grain, yielding trinucleate pollen.

FEMALE REPRODUCTIVE STRUCTURES

The megasporangiophore is the distinguishing feature of the angiosperms for it is normally a closed body (termed a *carpel*), furnished with a distinct stigma (often elevated on a style) on which the pollen germinates (Fig. 9.26). In only a few genera (e.g., *Reseda*) are the carpels open at maturity. A carpel is dorsiventral in symmetry and the fertile region is adaxial. One or several ovules may be present, and if the latter they are commonly borne in two series along the so-called "ventral suture" of the carpel (Fig. 9.26).

The ovules are much smaller than those of most gymnosperms, but are structurally similar. They may be upright, inverted, or occasionally more or less horizontal, these three orientations being termed *orthotropous*, *anatropous* and

Figure 9.24 Maturing microspores of *Catananche caerulea* (Asteraceae) lying in the tapetum. Anther transversely freeze-fractured. Scale bar 10 μm . (Unpublished micrograph provided by S. H. Barnes and S. Blackmore.)

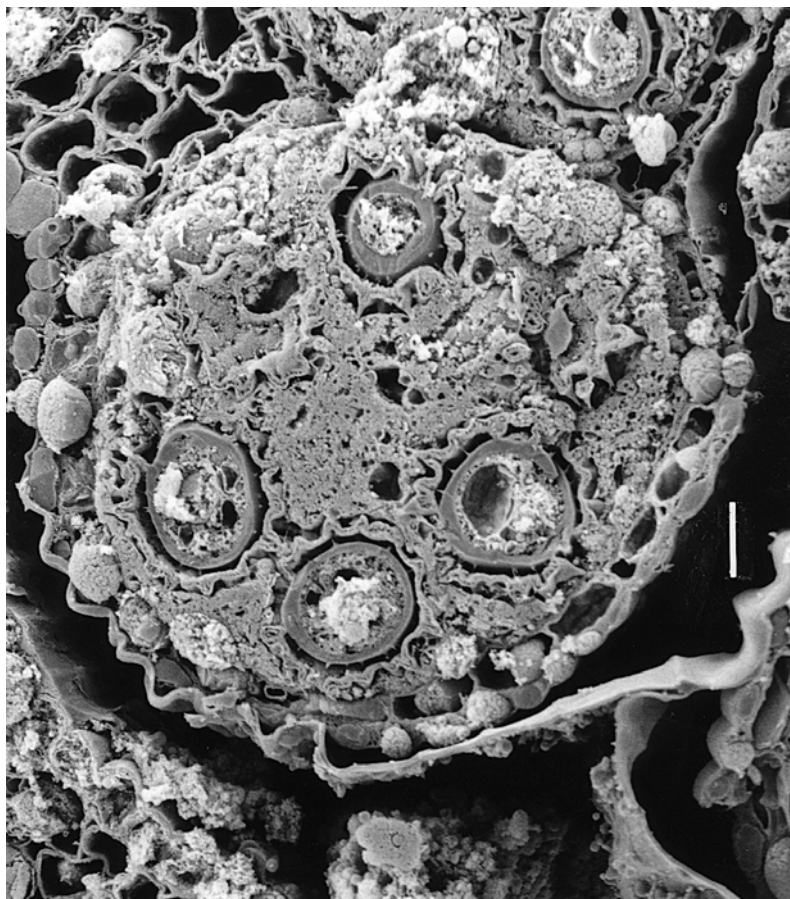
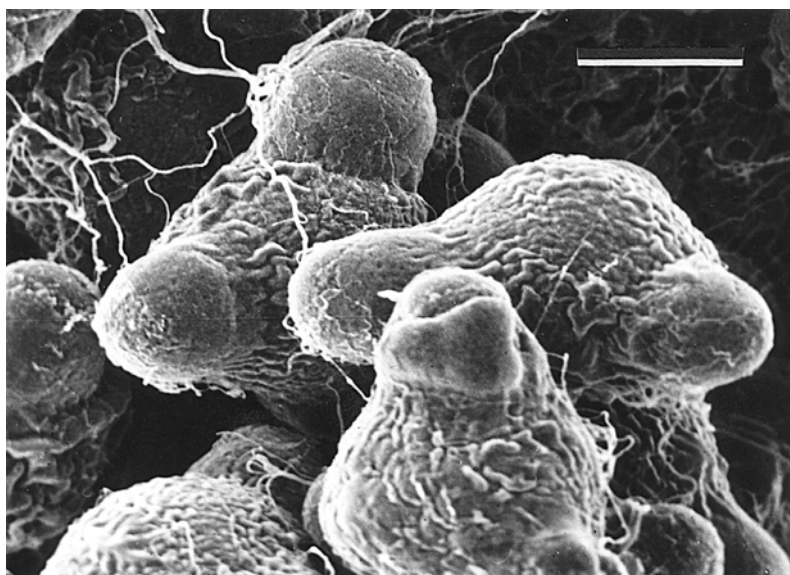

Figure 9.25 *Oenothera organensis*. Pollen grains (each with three projecting colpi), enmeshed in threads of viscin (a polymer produced by the tapetum), lying on the stigma. Scale bar 5 μm . (Photomicrograph by H. Dickinson.)



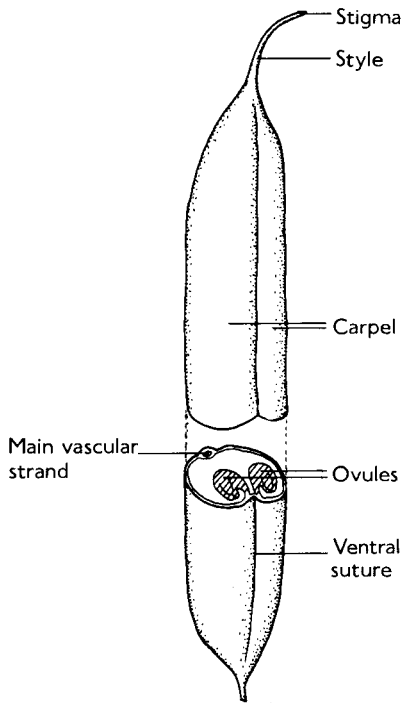

Figure 9.26 The simple carpel characteristic of the family Fabaceae (Leguminosae). This arrangement of the ovules is referred to as “marginal placentation”.

campylotropous respectively (Fig. 9.27). At least one integument is present, but in many families there are two, and in some as many as four. The last-formed integument, irrespective of the total number, sometimes becomes transformed into a fleshy aril in the fruit (as in the durian, *Durio*). The integuments normally develop uniformly, indicating the basic radial symmetry of the angiospermous ovule. A slender vascular trace enters the stalk of the ovule, but in only a few families does this extend into an integumentary vascular system.

THE FEMALE GAMETOPHYTE

The development of the female gametophyte, in the angiosperms termed the embryo sac, begins in a familiar fashion (Fig. 9.28a). A cell in the upper part of the nucellus, immediately below the layer of cells at its surface, becomes conspicuously large and surrounded by a callosed wall. Meiosis then leads to a tetrad of megaspores (Figs. 9.28b and 9.29a). Although the term “megaspore”, because of the evident homology of this cell with

the megaspore of the gymnosperms, is retained, the megaspore in the angiosperms is frequently smaller than the microspore. In many instances only the inner (chalazal) megaspore undergoes further development, and the female gametophyte is consequently said to be *monosporic* in origin. The nucleus of the megaspore enters a succession of mitoses, and, in step with the expansion of the ovule as a whole, the multinucleate embryo sac is formed (Figs. 9.28e and f, and 9.29b). In a frequent type of embryo sac there are eight nuclei, produced by three successive mitoses, which associate themselves with cytoplasm and arrange themselves in a definite pattern (Fig. 9.28e). Eight cells are usually identifiable at this stage, each bounded by a delicate membrane. At the micropylar end of the sac is a group of three cells, of which one (frequently with a weakly staining nucleus) is the egg cell. The cells accompanying the egg are termed *synergid* cells. The walls of these cells at their micropylar ends frequently have conspicuously labyrinthine walls. These form the so-called “filiform apparatus”.

At the other end of the sac (the chalazal end) is another group of three cells, referred to as the *antipodals*. The nuclei of the remaining two cells (termed polar nuclei) come together at the center of the sac and eventually fuse, thus giving rise to a central diploid fusion nucleus (Figs. 9.28f and 9.29b). During the development from the megaspore the boundary between the gametophyte and sporophyte remains distinct, and the mature embryo sac is commonly also surrounded by a callosed wall. This is known to be impermeable to large molecules such as nucleosides.

The foregoing is only one of the several kinds of development of the female gametophyte found in the angiosperms. In some families, notably the Onagraceae, the embryo sac develops from the outer and not from the inner megaspore, a feature of unknown cytological and physiological significance. Sometimes, as in *Allium* (onion), meiosis in the formation of the megaspores is incomplete, a dyad of spores being produced instead of a tetrad. The embryo sac, which develops directly from the inner spore, is then said to be *bisporic* in origin. Finally, in another kind of development (seen, for example, in *Lilium*), termed *tetrasporic*, the nucleus of the megaspore mother cell divides meiotically,

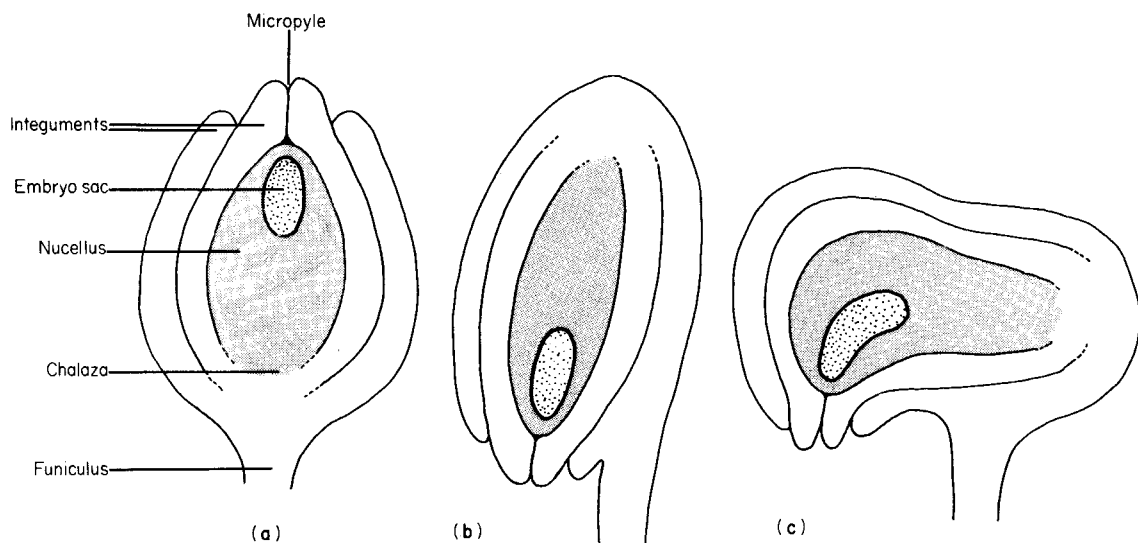

Figure 9.27 Forms of ovule orientation (diagrammatic).
(a) Orthotropous. (b) Anatropous. (c) Campylotropous.

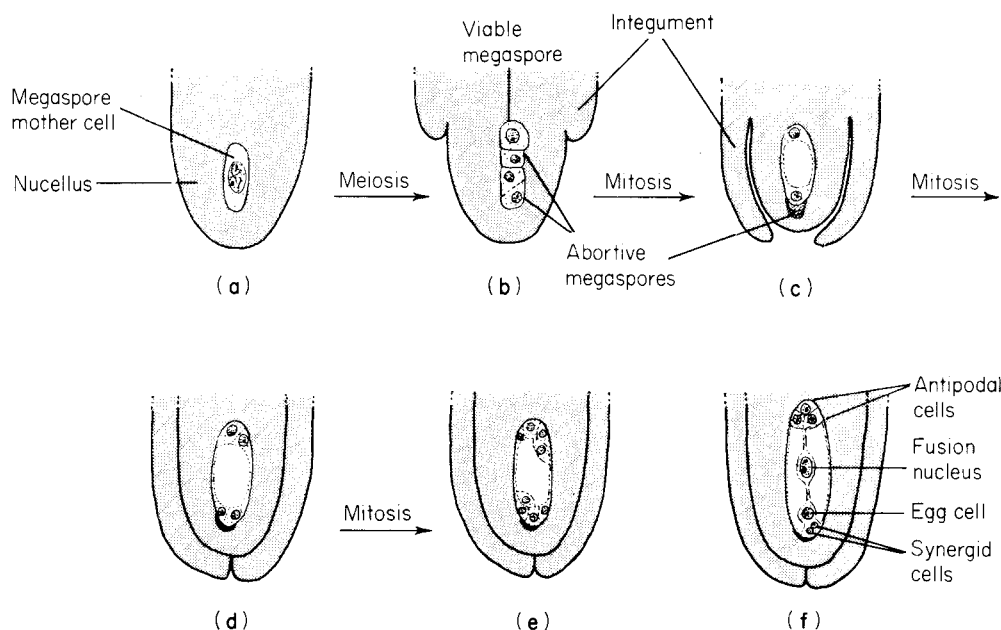

Figure 9.28 *Myosurus minimus* (mouse tail). The sequence of divisions leading to the production of a monosporic, eight-nucleate embryo sac. Diagrammatic; not to scale.

but the cell itself does not divide at all. Instead, mitotic divisions follow and the cell expands without interruption to form the sac. Bisporic and tetrasporic embryo sacs occur in a wide range of

families (and have already been noted in *Gnetum* (p. 261)), and there is no justification for regarding this kind of origin as abnormal. Another kind of variation lies in the number of nuclei in the mature sac. Although this is commonly eight, irrespective of the mode of origin of the sac, others are known containing four or sixteen. The cytology of development is also variable.

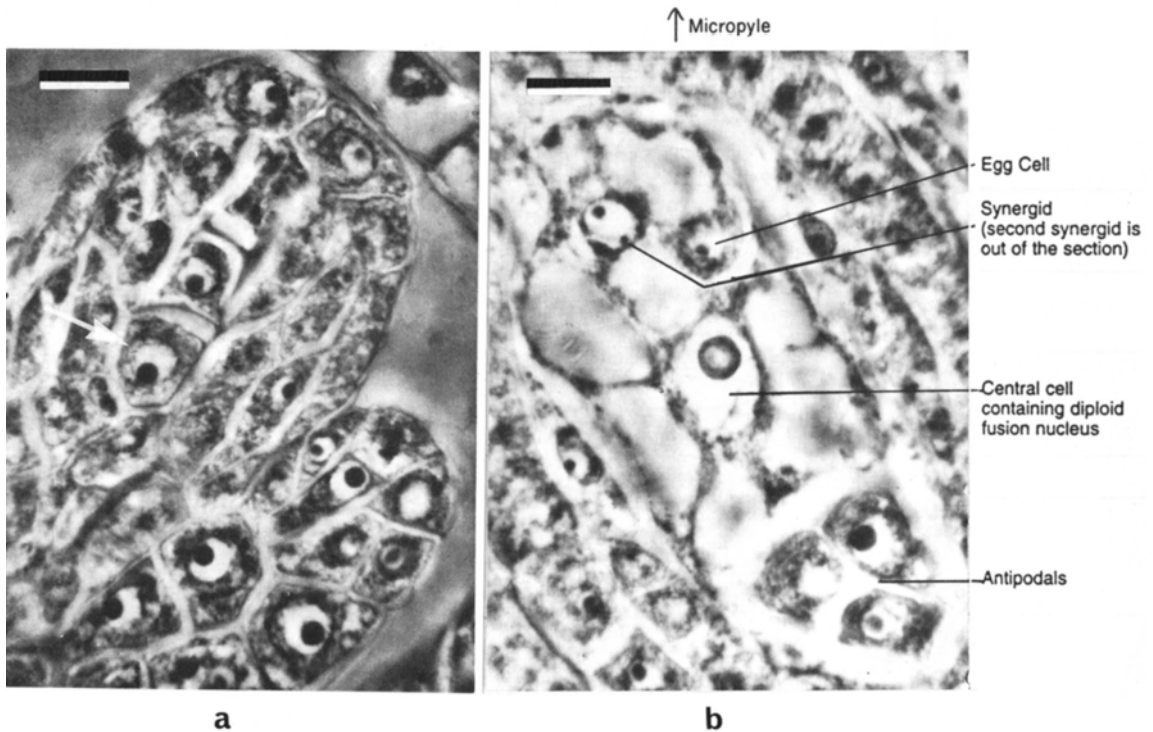

Figure 9.29 *Myosurus minimus*. The initiation and completion of the female gametophyte. (a) The tetrad of spores resulting from meiosis. The innermost (indicated by the arrow) is the viable megaspore. (b) The mature embryo sac. Scale bars 10 μm .

Although where sexual reproduction is normal the egg nucleus remains haploid, the chalazal polar nucleus may contain more than one set of chromosomes so that the central fusion nucleus becomes triploid or even, as in *Fritillaria*, tetraploid.

ARCHITECTURE OF THE FLOWER

The arrangement of the reproductive organs in the flower is often of considerable complexity, and floral morphology is a specialized field with its own terminology. Here we shall use only as much of this terminology as is necessary for general discussion, and for further details the reader must consult specialist works. To facilitate illustration of the principles involved in the structure of the flower, we shall first consider a bisexual flower in which the components remain separate (Fig. 9.30), a situation seen, for example, in *Ranunculus*. The flower terminates an axis, and the transition from

the vegetative to the reproductive region is marked by the occurrence of one or more whorls of sterile structures resembling rudimentary leaves. These form collectively the **perianth**. Where two whorls are present the segments of the outer whorl are frequently green (and termed **sepals**), whereas those of the inner are brightly colored (and termed **petals**). These two parts of the perianth are termed **calyx** and **corolla** respectively. Following closely upon the perianth are the stamens, forming collectively the **androecium**. The stamens may be either indefinite in number and spirally arranged (as in *Ranunculus*), or definite and arranged in whorls, the positions of individual stamens often then bearing a clear relation to each other and to those of the preceding perianth segments.

The termination of the reproductive axis, often termed the **receptacle**, bears the carpels. This female region is called the **gynaecium** or ovary. The carpels may again be spirally arranged, as in *Ranunculus*, or in a single whorl. In the latter event the carpels usually alternate in position with the stamens of the uppermost whorl.

In unisexual flowers the organs of one sex are

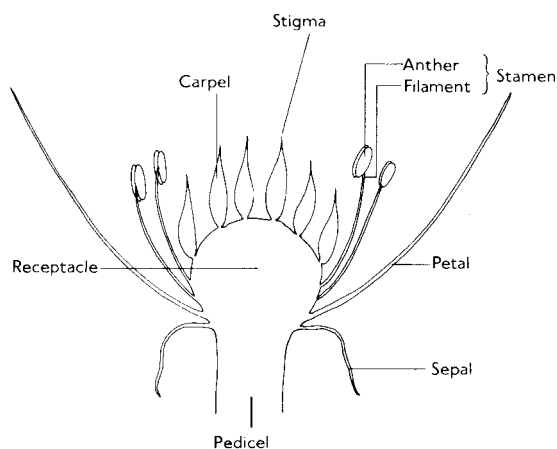

Figure 9.30 Longitudinal section of a flower with separate components. Diagrammatic.

absent or non-functional, although the bisexual condition can sometimes be brought about by treating the very young flower with growth substances such as gibberellic acid. Unisexual flowers may approach the limits of reduction, a feature well seen in catkin-bearing trees. In *Populus*, for example, the male flower consists of nothing more than a disk bearing up to 20 stamens, and in *Salix*, where the male flower is similar, the number of stamens is commonly no more than two. Congenital fusion of parts of similar nature is widespread in flowers. Both the calyx and the corolla independently may become tubular, the composite nature of the tube being indicated by lobes or teeth at its mouth. Filaments of whorled stamens may also fuse for most or only part of their lengths, leading to a cylindrical androecium. Fusion of carpels leads to a syncarpous ovary, in which the individual carpels are often represented by compartments (or loculi), as in the *Amaryllidaceae*. Externally the composite nature of the ovary is often indicated by lobing, or by the style, which rises from the center of the ovary, breaking up into branches equivalent in number to the constituent carpels. The ovary may sometimes be sunken in the receptacle (as in *Rosa*), or in some other way surmounted by the perianth and androecium, leading to clearly *epigynous* flowers. Sterilization of one or more stamens may occur, giving rise to staminodes which may either persist as rudimentary structures (as in

Scrophularia) or occasionally become enlarged and brightly colored, and play a conspicuous part in the organization of the flower (as in *Canna* and *Iris*). Both sterilization and congenital fusion of parts are involved in the complex flowers of the orchids. Nectaries may be associated with almost any part of the flower, depending upon the species.

ONTOGENY OF THE FLOWER

Although in the gymnosperms the apices giving rise to the reproductive and vegetative axes differ little in organization, in angiosperms they are usually easily distinguishable. In becoming reproductive an apex flattens considerably and may even become concave, regions previously quiescent now showing numerous mitoses. This has given rise to the concept of the vegetative apex containing a *meristème d'attente* active only in the reproductive phase. The perianth whorls and sporangiophores are often produced in acropetal sequence, the members of successive whorls alternating in position, but this is not always so. The direction of initiation may even become locally reversed, and primordia appear between the whorls of those already laid down. This phenomenon affects particularly the androecium, with conspicuous results in the symmetry of the mature flower. In some *Caryophyllaceae*, for example, a whorl of five stamen primordia appears, each stamen alternating in position with the preceding petals. A second whorl of stamens is then initiated basipetally, the stamens alternating with those of the first whorl, and hence standing opposite the petals. In this way an *obdiplostemonous* flower is formed.

Although the differentiation of the gynaecium usually terminates the reproductive axis, the axis may sometimes continue to grow and produce a second flower, an aberration not uncommonly seen in *Geum*. Abnormal growths of this kind are usually the consequence of mutations. Such mutations, causing the appearance of an organ in an unaccustomed position, are termed *homoeotic*, and the phenomenon in general, *homoeosis*. Homoeotic mutations, produced experimentally, are currently proving of great value in analyzing the factors responsible for the ordered development of the normal flower.

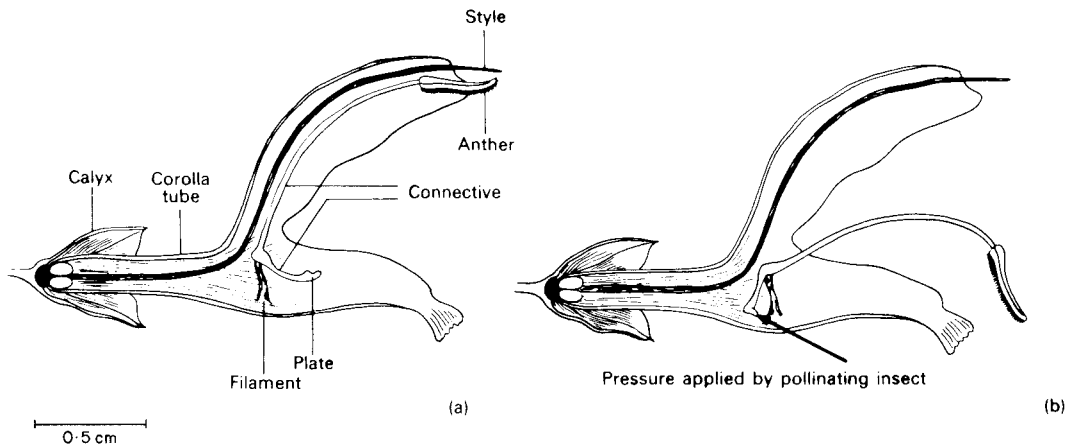

Figure 9.31 *Salvia pratensis*. (a) Half flower showing the normal position of the stamen. (b) The same after the plate has been depressed. (After Kerner von Marilaun and Oliver. 1902. *The Natural History of Plants*. Blackie, London.)

From the effect of the homoeotic mutations, it can be inferred that the unmutated gene (“wild type”) is directly concerned with the normal development of the organ in question. Despite the major advances being made in this field, the manner in which the interaction of the products of the genes involved leads to normal morphogenesis remains a formidable problem.

A quite exceptional situation appears to exist in the Mexican genus *Lacandonia*. Here the apical region of the floral meristem produces anther primordia. Carpel primordia arise from the flanks of the meristem. The development of the male and female organs takes the normal course. As in the Onagraceae, the surviving megaspore is situated at the micropylar end of the linear tetrad.

POLLINATION AND GROWTH OF THE MALE GAMETOPHYTE

Pollination in angiosperms is occasionally dependent upon aerial dispersal of the grains (as in catkin-bearing trees), but frequently involves the participation of insects as carriers. Various mechanisms have been evolved which ensure that insects visiting flowers in search of nectar become dusted with pollen, which then becomes transported to stigmatic surfaces in other flowers. A familiar example of such a pollination mechanism is provided by *Salvia pratensis* (sage), a species pollinated by the bumblebee. The stamens have

short filaments, but a greatly elongated connective (Fig. 9.31). The longer upper portion of the connective terminates in an anther, but the shorter lower part in a plate blocking the approach to the nectary. A bee attempting to reach the nectar displaces the plate. Since the connective is hinged about the filament, the anther is in this way forced on to the insect’s back, coating it with pollen (Fig. 9.31). Pollen-collecting in some cases is facilitated by the insect concerned (often a bumblebee) generating a low-frequency buzz with its wings corresponding to the natural frequency of vibration of the anthers visited. The shaking resulting from this resonance loosens the pollen, which is then showered on to the bee. Flowers showing this kind of “buzz pollination” often have reflexed petals, with the anthers forming a fully exposed projecting cone (as in many Solanaceae, including the familiar potato). The pollen is usually small, 25 μm or less in diameter, and the discharge is often through an apical pore in the anther. A remarkable situation is encountered in *Mucuna holtonii*, a twining legume (Fabaceae) of Central America. Pollination is by bats, who visit the flowers for nectar. When the flower is mature, and pollen and nectar are available, the concave vexillum (“standard” petal) on the upper side of the flower becomes erect. The concavity of the vexillum is such that it accurately reflects the echolocation calls of the species of bat involved. The bats are thereby able to locate with little error the flowers which it is profitable to visit.

In some species pollen tends to cohere because

Figure 9.32 Development of a pollen grain in which the final nuclear division occurs in the tube. (a) Condition in the anther during final stages of the growth of the wall. (b) Condition during liberation and pollination. (c) The sperm cells and vegetative nucleus ("male germ unit") move forward with the pollen tube. Diagrammatic.

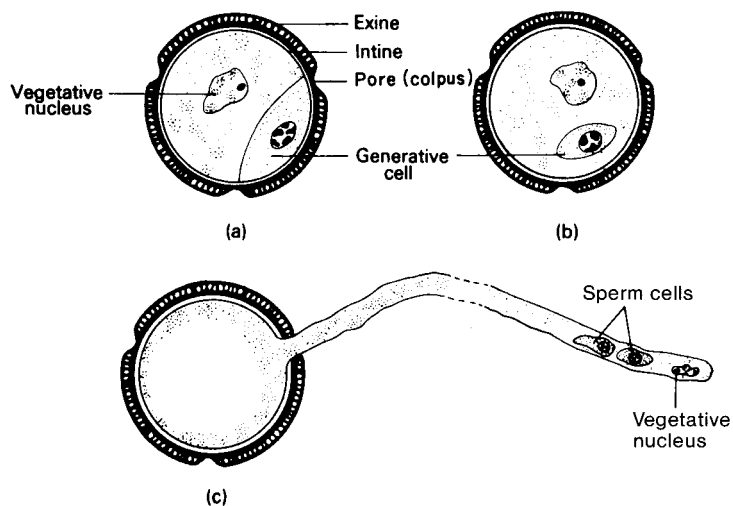

of the presence of viscin threads (Fig. 9.25), a product of the tapetum. In *Impatiens*, similar threads are derived from fibrous tissue in the wall of the anther. These threads remain attached to the inner thecal walls and tend to restrain the escape of the pollen. In orchids the pollen regularly coheres in a mass referred to as a *pollinium*. This adheres to a visiting insect, and is transferred intact to the female region of another flower. The pollinium can also be removed by a fine probe, a technique used by horticulturalists in hybridizing orchids. A bizarre form of pollination is found in some orchids (e.g., *Ophrys speculum* of the western Mediterranean) where the pattern and conformation of the lip recall the female of the insect concerned, and even an odor may be released resembling the pheromone of the species. The male insect, in attempting to copulate with the lip of the flower, detaches the pollinium and involuntarily carries it to another flower. In addition to bats, a few tropical flowers are pollinated by birds, and *Aspidistra*, once a favorite pot plant, whose flowers are more or less at ground level, by snails. The appropriate authorities must be consulted for more detailed accounts of pollination mechanisms.

The pollen, having been brought into contact with the stigma (to which it may be firmly attached as a consequence of electrostatic forces), imbibes water from the surface of the stigma. Germination follows, usually within a few hours. A pollen tube breaks through a colpus in the exine of the grain (Fig. 9.32) and, provided there are no incompatibility barriers, penetrates the style. The growth of the tube is largely confined to the tip, behind which the wall becomes callosed. There is

notable physical activity in a growing tube, possibly a consequence of interaction between actin microfilaments and myosin on the outside of organelles. The passage of the tube toward the ovules often follows a tract of specialized, thin-walled, transmitting tissue. Specialized arabinogalactan proteins in the walls of the transmission tissue have been associated in *Nicotiana* (tobacco) with directing the growth of the tube, but in general the direction may be dependent upon metabolic gradients of a quite simple kind. In some species (e.g., *Lilium*) the style is hollow. The pollen then grows down the surface of the cells lining the canal, the outer walls of which are frequently labyrinthine. Pollen tubes occasionally branch, branching in some species (e.g., *Betula*, birch) being frequent and conspicuous. In some tree species (e.g., *Alnus*), where pollination takes place in winter or early spring, development of the male gametophyte may be arrested for weeks or months, completion of development and fertilization taking place in summer.

If the generative cell has not already divided (p. 287) into sperm cells it does so in the extending tube. The two sperm cells are irregular in shape and together with the vegetative cell sometimes form a complex referred to as the "male germ unit". This moves forward with the growth of the tube and remains close to the tip (Fig. 9.32c). Although the mechanism driving the complex forward is not yet clear, actin microfilaments, prominent in the growing tube, together with

myosin are probably again involved. The distribution of the cytoplasmic organelles between the two sperm cells is not always equal. In *Plumbago*, for example, in one of the sperm cells mitochondria predominate, and in the other plastids. In some species (e.g., *Lycopersicon* (tomato) and *Gossypium* (cotton)) plastids are either excluded from the generative cell or degenerate during spermatogenesis, leaving only mitochondria in the cytoplasm. In a number of legumes it has been observed that, although the generative cell retains plastids, they appear to lose all traces of DNA. Instances are known in which the sperm cytoplasm lacks organelles altogether (e.g., *Apium*, celery).

Surprisingly, the sperm cells of tobacco, if freed precociously by enzyme treatment, will readily fuse with each other (a feature also of meiotic protoplasts in lily). Although the properties of the plasmalemma throughout meiosis and in the male gametophyte of angiosperms have not been studied in detail, readiness of like cells to fuse may be a general feature. The spatial organization of the "male germ unit" may serve to keep the sperm cells separated until their release into the embryo sac.

Variations in the development of the male gametophyte are not uncommon. In some species, for example, the pollen grains put out two or more tubes, but only one carries the gametes. Some flowers (termed *cleistogamous*) do not open, but are nevertheless fertile. A familiar example is provided by *Viola canina* (dog violet). The normal (*chasmogamous*) flowers of spring produce little seed, but the bud-like cleistogamous flowers of summer are fully fertile. Only minute petals are present and all but the two abaxial stamens are abortive. The pollen of these two surviving stamens, however, is viable and germinates in the anther. The pollen tubes grow through the wall into the stigma. Even more extensive growth of the pollen tube through vegetative tissue is shown by the aquatic *Callitriche* (starwort). Although the plant is monoecious, the flowers are unisexual. The submerged flowers remain closed and the pollen germinates in the anther. The tubes then grow for long distances to female flowers at the same node, penetrating the ovary from below.

FERTILIZATION

A pollen tube enters the ovule either by way of the micropyle or by growth through the chalazal end. Entry into the embryo sac itself is usually at its micropylar end. A region near the tip of the tube, possibly in consequence of enzymes produced by synergid cells, soon breaks open. The contents of the tube are discharged into the sac. The discharge may take place, as in *Gossypium*, into one of the synergids. The sperm cells are then stripped of their cytoplasm and only the male nuclei continue into the sac. Following the entry of the sperm cells or nuclei the "double fertilization", characteristic of the angiosperms, then ensues. One gamete fuses with the egg cell and the other moves through the sac and fuses with the central cell. Fusion of the nuclei gives rise to the diploid zygotic nucleus and the (usually) triploid endosperm nucleus respectively. The movements of the sperm cells may not always be random. In *Plumbago*, for example, where the gametes are not freed of their cytoplasm by the synergid cells, and the gametes differ, the cell richer in plastids fuses preferentially with the egg cell. In general, however, the inheritance of plastids seems to be principally maternal, and other well-substantiated examples of biparental inheritance (e.g., *Pelargonium*) are few. The inheritance of mitochondria is more difficult to determine and may be more widely biparental. In *Gossypium* and similar instances of synergid intervention, the inheritance of the cytoplasm and its components is presumably entirely maternal.

The amount of DNA in the sperm nucleus appears to be variable with species. In *Zea* the nucleus contains the 1C amount. Assuming symmetry, the content of the egg nucleus will also be 1C, and that of the zygotic nucleus 2C. The zygotic nucleus has thus to pass through an S-phase before diploid mitosis can occur. In *Arabidopsis*, however, the DNA content of the sperm nucleus has been found to double during development of the male gametophyte. Again, assuming symmetry, following fusion the zygotic nucleus will already be in the 4C condition, rendering a pre-mitotic S-phase unnecessary (cf. *Gnetum*, p. 261).

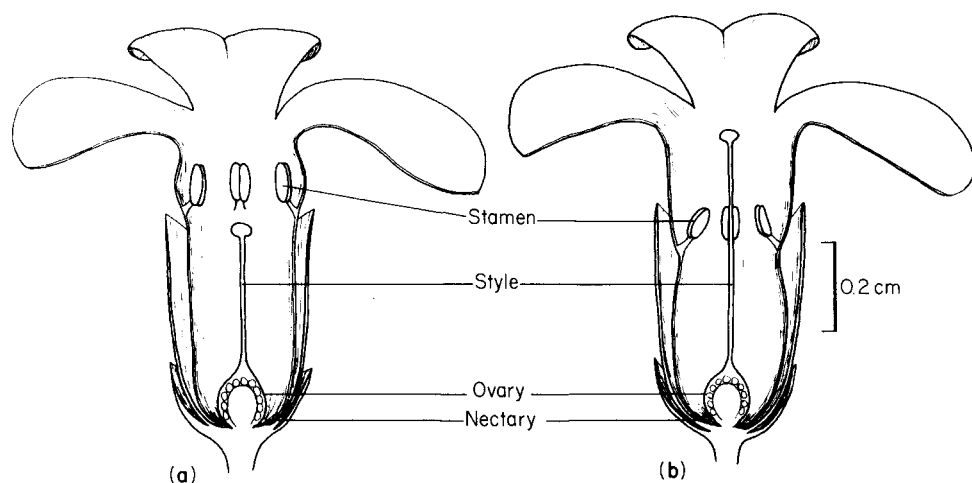

Figure 9.33 *Primula* sp. Half flowers showing (a) thrum arrangement and (b) pin arrangement.

CONTROL OF MATING

In addition to protogyny and protandry (p. 285) various devices are found which discourage or prevent self-pollination and the possible deleterious effects of inbreeding. Conspicuous amongst these are those involving dimorphic flowers. In *Primula*, for example, the two kinds of flowers are termed “thrum-eyed” with a short style and elevated stamens, and “pin-eyed” with a long style and lower stamens (Fig. 9.33). An insect searching for nectar at the base of the corolla tube will tend to pass pollen from the stamens of the “pins” to the styles of the “thrums” and vice versa. This morphological device is accompanied by a physiological difference which causes the imperfect growth of “pin” and “thrum” pollen in their own styles. The mechanism, which is genetically controlled, depends upon the presence of antibodies in the style which precipitate essential enzymes in the pollen tubes of pollen from the same or like flowers. The pollen of the thrum flowers is some 50 percent greater in diameter than that of the pin, and this is correlated with a greater rate of extension of the pollen tube of the thrum pollen. *Lythrum salicaria* and some other species have a similar mechanism involving three kinds of flowers, the diameter of the pollen grains again being related to the position of the stamens producing them. Physiological systems of self-incompatibility unaccompanied by structural devices in

the flower are widespread. In *Linum*, for example, successful growth of the pollen tube can take place only if the ratio of the osmotic pressure of the style to that of the pollen is the order of 1:4, a relationship never present between pollen and style of the same flower. Other mechanisms are seen in *Raphanus* (radish) and *Brassica* (cabbage). Here the pollen germinates following selfing, but penetration of the tube is impeded by the rapid development of pads of callose in the stigmatic cells beneath its tip, although this does not seem to be the sole cause of the infertility of self-pollination. In *Oenothera* the incompatible tube penetrates, but in the style it becomes plugged and growth ceases.

In general two kinds of incompatibility can be distinguished, sporophytic and gametophytic. In the former the failure of pollination is a consequence of products of tapetal origin (called collectively *tryphine*) carried by the exine of the pollen grain. Interaction of certain of these products with the papillae at the surface of the stigma leads to arrest of the incompatible pollen tube. The brassicas show this type of incompatibility very clearly. In gametophytic incompatibility the interaction is directly between the male gametophyte itself, represented by the pollen tube with its thin permeable wall, and the tissue of the style. The distinction between sporophytic and gametophytic systems is not, however, absolute. In *Raphanus*, for example, in addition to an initial sporophytic system at the surface of the stigma, careful breeding experiments have revealed

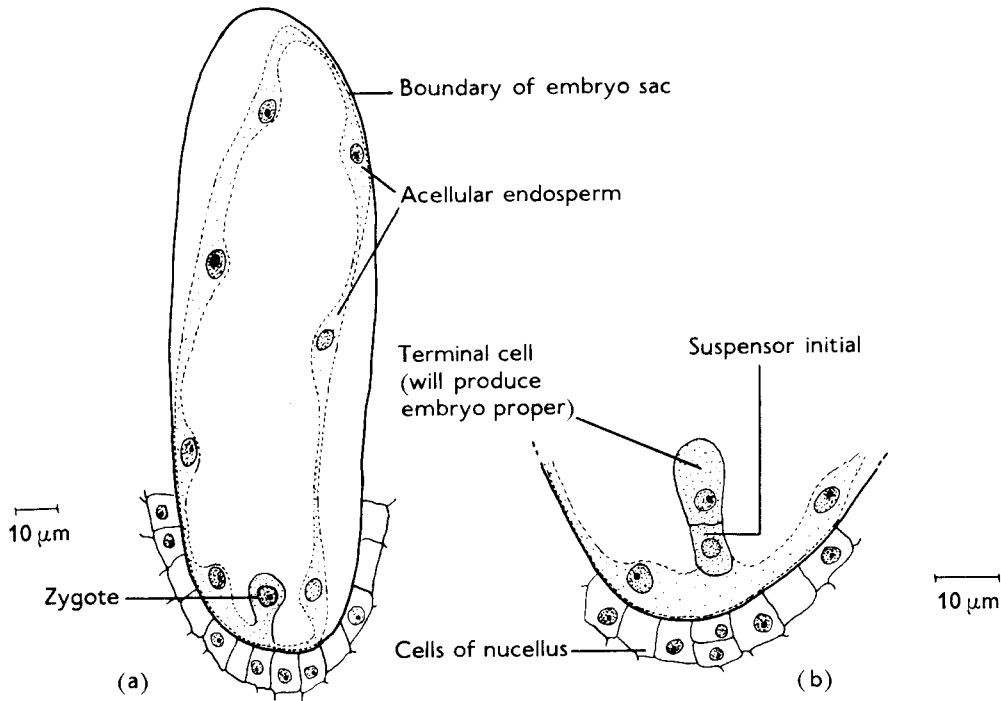

Figure 9.34 *Myosurus minimus*. Longitudinal section of embryo sac following fertilization. (a) After several divisions of the primary endosperm nucleus. (b) After the first division of the zygote. The zygote is at the micropylar end of the sac.

further interactions of a gametophytic kind in the style. These may be relics of an earlier gametophytic system which has become cryptic. It seems likely that basic to both the sporophytic and gametophytic kinds of incompatibility is an interaction, similar to a defense reaction, which is seen throughout land plants generally wherever the cells of gametophyte and sporophyte are intimately apposed (see, for example, pp. 103, 208).

Other, less studied, forms of incompatibility also exist. In species of *Castanea* (chestnut), for example, incompatible pollen tubes liberate gametes, but fertilization fails. In *Gasteria* incompatible pollination leads to the formation of embryos, but they subsequently abort.

EMBRYOGENY

Following fertilization the contents of the embryo sac are commonly resorbed, the zygote and endosperm being the only sites of further growth. As in other seed plants, the first dividing wall of the

zygote lies transverse to the longitudinal axis of the ovule (Fig. 9.34), and the subsequent embryogeny is endoscopic. Free nuclear division is not, however, a characteristic of the development of the proembryo, as it is in many gymnosperms. Instead, embryogenesis begins with a series of precise cell divisions, showing little variation between species, and meristematic activity does not pause until the embryo differentiates and the seed is formed. The mature embryo (except in the orchids where it remains an undifferentiated protocorm) possesses a stem apex (*plumule*), one or two cotyledons, and a root apex (*radicle*). Even though the mature embryo may be folded (as in *Capsella bursa-pastoris* (shepherd's purse), Fig. 9.35), the radicle is always directed toward the micropyle. The extent to which the fully formed embryo has drawn upon the food reserves of the endosperm varies widely with the species. In "endospermous" seeds this reserve remains considerable, but in the "non-endospermous" little remains, and much of the food materials in these seeds often becomes transferred to the cotyledons. Examples of such seeds are those of the legumes where the swollen cotyledons entirely replace the endosperm in both space and function (Fig. 9.36a).

Figure 9.35 An almost mature seed of *Capsella bursa-pastoris* sectioned longitudinally and showing the orientation of the embryo.

FEATURES OF THE ENDOSPERM

The formation of the endosperm usually begins before the division of the zygote. The primary nucleus and its daughters undergo successive mitoses, giving rise to an endosperm that is either cellular from the first, or initially acellular (Fig. 9.37a) and only later partly or wholly cellular. Cytologically the endosperm is a remarkable tissue, with unique cytoplasmic and nuclear properties, significantly different from the haploid "pseudo-endosperm" of the gymnosperms (see p. 252). It is a rich source of growth-regulating substances or their immediate precursors, many of them not yet chemically identified. The successful culture of young embryos and other plant tissues, for example, is often impossible in fully defined media, but is facilitated by the addition of coconut milk (the liquid endosperm of the coconut seed). Endosperm itself can sometimes be obtained in pure culture and, since the cell walls of young endosperm often have little thickening, such cultures have been used to study the details of mitosis *in vivo*. In some endosperms the nuclei reach high and irregular levels of endopolyploidy, and amitotic nuclear division has been reported in a number of instances.

In keeping with the function of providing for the nutrition of the embryo and young plant, the cells of the mature endosperm are often filled with food materials. Carbohydrates, fats and proteins are present in various labile forms. The occurrence of these materials is sometimes so abundant that the seeds concerned acquire vast economic importance. The cereal grains, where the endosperm yields starch and protein in a form

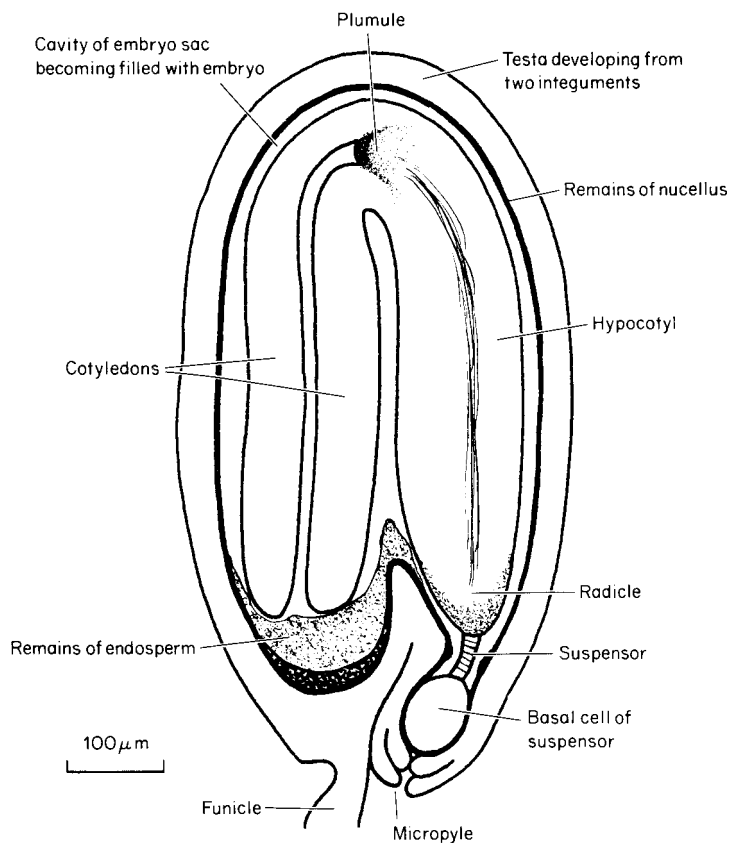

readily palatable to humans, and the oil seeds, such as *Ricinus* (castor bean) and *Linum* (linseed), are familiar examples. Polymers of mannose (mannans) also occur as reserve products, a peculiar example being provided by *Phytelephas*, a palm. The large endosperm of this species becomes so heavily indurated with a mannan that it enters commerce under the name of "vegetable ivory", once used for the manufacture of buttons and billiard balls. In a few plants, notably the orchids, the endosperm undergoes only trifling development and in others it is remarkably aggressive. In *Pedicularis*, for example, the endosperm produces haustoria which invade the integumentary tissue, leading eventually to its complete resorption.

In relation to the gymnospermous cycle, the endosperm is a new feature in the life cycle of the seed plants. Powerful arguments, based on the double fertilization which occurs regularly in *Ephedra* (p. 266), have been made for the endosperm being in origin a highly modified second embryo. It is significant that there are many indi-

cations that endosperm may retain embryogenic properties; records of "endosperm embryos" are not uncommon in older papers. Nevertheless, isolated central fusion cells of maize, fused with a single sperm cell *in vitro*, develop into endosperm with no indications of embryogenesis. The developmental pathway of the "fertilized" central cell thus seems to be firmly endospermal *ab initio*. The genomic constitution of the fusion product must normally suppress embryogenesis, although escape from this constraint is evidently occasionally possible. The complexity of the situation is made evident by the existence of mutants of certain plants, normally showing a regular sexual cycle, which produce endosperm (and a seed) in the absence of fertilization. It seems that the wild type of the gene complex involved yields a protein which, in normal reproduction, suppresses development of the endosperm until after fertilization.

As a consequence of its polyploid genome, the gene products of the endosperm are likely to be compatible with those of the diploid sporophyte, and in consequence immediately available for the metabolism of the embryo. There is evidence, however, that satisfactory growth and morphogenesis in the embryo is dependent upon an undisturbed "endosperm balance number" (normally 2♀: 1♂, the haplotype being provided by the pollen parent), and a ploidy ratio within the ovule of 2 (maternal tissue):3 (endosperm):2 (embryo). The endosperm nucleus is clearly heterogeneous in the case of interspecific hybrids, and this may account for the seeds of interspecific crosses frequently being inviable. In this form of infertility the embryo often dies in the seed, apparently from starvation. Sometimes the embryo can be rescued and grown to maturity in culture. Normally, the juxtaposition of embryo and endosperm provides little impediment to the transfer of metabolites. This no doubt makes for the generally rapid development of the angiosperm embryo compared with that of the gymnosperms, conferring upon them a significant selective advantage.

MATURATION OF THE SEED AND FRUIT

Associated with the maturation of the embryo are considerable changes in the nucellus and integuments. In some seeds food reserves are laid down

in the nucellus, and in the mature seed this then forms a distinct tissue known as the *perisperm*. Frequently, however, only a little of the nucellus remains, and this together with the integument becomes transformed into the outer covering of the seed. This often involves the deposition of much cutin and lignin, and the resulting seed coat (*testa*) is consequently often remarkably impervious.

As the seeds mature the ovary becomes a fruit. There are numerous forms of fruits, but the wall is formed either from the carpel (*pericarp*), or by the fusion of the pericarp with surrounding tissues. The pericarp may become hard, as in nuts, or dry and brittle, as in the capsules of the Caryophyllaceae, or partly or wholly fleshy, as in common edible fruits. In berries (e.g., tomato, *Lycopersicon*) the pericarp is wholly fleshy, in drupes (e.g., cherry, *Prunus*) the outer part becomes fleshy while the inner hardens to form a stone, and in pomes (e.g., apple, *Malus*) a thin layer of pericarp hardens while the remainder fuses with the surrounding receptacle and forms the flesh. Where fruits are palatable to humans or animals the seeds commonly have a testa able to survive passage through the digestive tract.

Seeds are often distributed while still in the fruit, and the fruit in this instance commonly bears hooks or spines (as in the burdock, *Arctium*), or wings (ash, *Fraxinus*), or parachute-like fringes of hairs (as in the pappus of many Asteraceae), which assist dispersal by attachment to animals or by wind. Other angiosperms have evolved mechanisms whereby tensions are set up in the carpel wall as it dries, causing eventually an explosive dehiscence which scatters the seeds far and wide (e.g., spurge, *Euphorbia*). This brief summary of a wealth of morphological detail shows how the angiosperms have evolved a great variety of ways which ensure wide dissemination, a feature in which they differ sharply from the gymnosperms, again contributing to their present success.

DORMANCY AND GERMINATION

The cause of the cessation of growth of the embryo as the seed matures is not altogether clear, but the partial dehydration of the interior of the seed at this time is probably an important factor. Certainly the imbibition of water is

Figure 9.36 (a) *Vicia faba*, hypogeal germination. (b) *Sinapis* sp., epigeal germination.

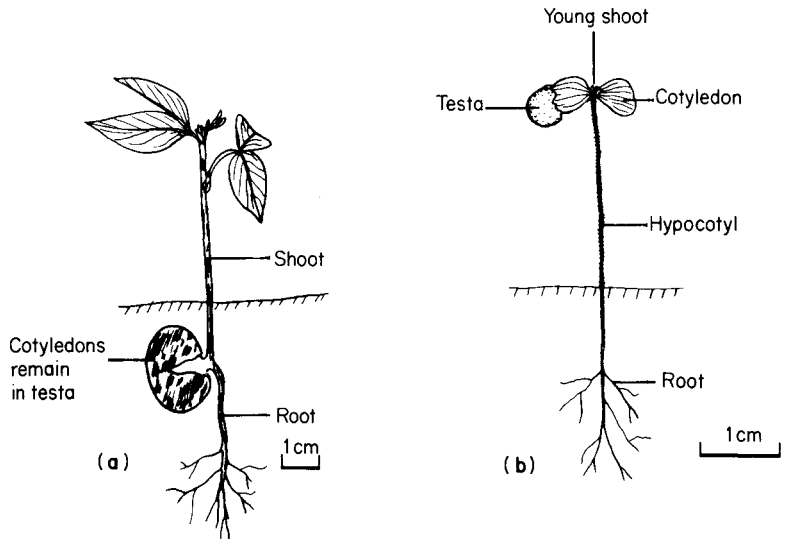

essential for renewed growth, but this by itself is often insufficient for the production of viable seedlings. A period of dormancy (“after ripening”) must often ensue before successful germination will occur. The seeds of some species also need to be chilled, a treatment which apparently activates the enzymes which make available to the embryo the food reserves of the endosperm. This cold requirement also provides a biological advantage, since the seeds in a seasonal climate will not germinate until after the winter, and the seedlings thus avoid prolonged freezing. Other seeds, for example those of lettuce, germinate only after illumination, and the phytochrome system (which depends upon a protein sensitive to red light) is here involved in the renewal of growth. In *Banksia* and some other Australian Proteaceae the fruits open only after bush fires (cf. “closed cone” pines, p. 239), and the seeds germinate in the ash layer. Not only is this a more favorable substratum than loose humus, but the seeds of at least one species need heat treatment before they will germinate. The seeds of many tropical plants, on the other hand, germinate immediately in moist conditions, and soon lose their viability if stored. The tropical mangroves, plants of coasts and estuaries, are outstanding in that in some species the embryo continues to develop in the ovules, and a swollen radicle protrudes from the withered flower. The young plant eventually falls and, with the radicle correctly oriented for penetration of the mud beneath, it rapidly establishes itself.

As a germinating seed imbibes water there is usually considerable swelling and eventually rupture of the testa. The radicle is the first organ to emerge, followed closely by the plumule. The cotyledons may remain within the seed at or below soil level (*hypogeal* germination), as in *Vicia faba* (broad bean) (Fig. 9.36a), or become elevated

(*epigeal* germination) and photosynthetic, as in *Sinapis* (mustard) (Fig. 9.36b). Germination is basically similar in monocotyledons and dicotyledons, but in the grasses the plumule and radicle are first enclosed in sheaths called the *coleoptile* and *coleorhiza* respectively. Coleoptiles show marked phototropic and gravitropic responses and, being devoid of appendages, are particularly suitable for the experimental investigation of these phenomena.

Asexual reproduction

In addition to sexual reproduction, the angiosperms show many forms of asexual reproduction. One form of such reproduction, termed *apomictic*, superficially resembles sexual reproduction. Although its presence can be readily inferred from the genetics of the species concerned, the elucidation of the accompanying cytology has sometimes demanded very careful investigation. In one kind of apomixis, *parthenogenesis*, the egg develops without fertilization. Where this occurs regularly, the nuclei involved in the formation of the embryo sac and the nucleus of the egg contain an unreduced number of chromosomes. Such embryo sacs may result from a modification of the meiosis which yields the megaspores (as in *Taraxacum*), or from the spatial and functional replacement of the megaspore by an adjacent nucellar cell (as in *Hieracium*, hawkweed). Although the formation of the embryo occurs

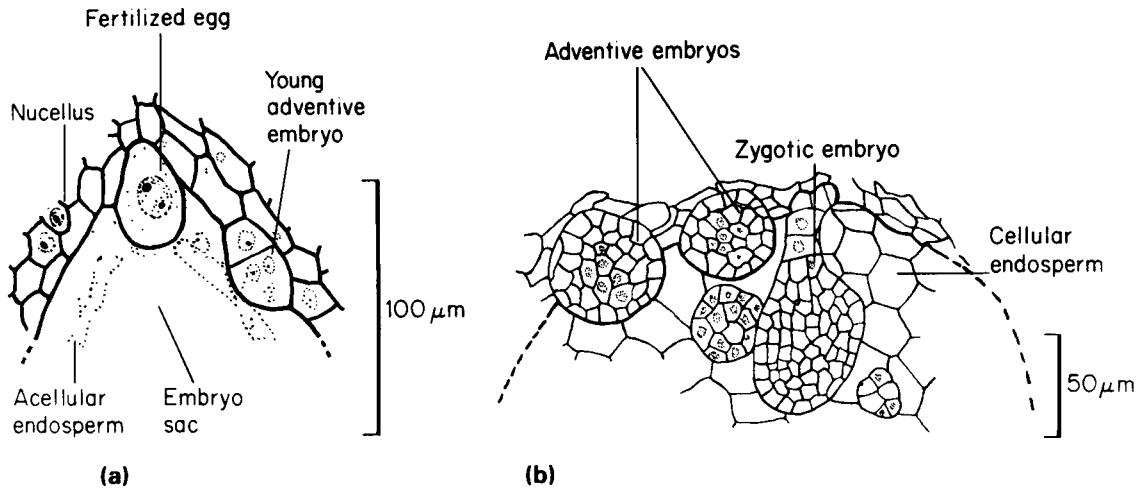

Figure 9.37 *Poncirus (Citrus) trifoliata*. Longitudinal section of micropylar end of embryo sac in which adventive embryony is occurring. (a) Immediately after the fertilization of the egg. (b) After the endosperm has become cellular. Only the true embryo has a suspensor. (After Osawa, from Maheshwari. 1950. *An Introduction to the Embryology of Angiosperms*. McGraw-Hill, New York.)

without fertilization, the stimulus of pollination is often needed before the process will begin (a phenomenon known as *pseudogamy*), and an endosperm may even be formed with the participation of one of the sperm nuclei. The pollen, although without genetic effect in the species producing it, is sometimes able to form hybrids with related sexual species. This parallels the situation in apogamous ferns, such as *Dryopteris affinis* (p. 209).

Another form of apomixis involves the formation of embryos directly from the cells of the nucellus, often in addition to the normal zygotic embryo. A classical example of this phenomenon, known as *adventive embryony*, is provided by *Poncirus* (Fig. 9.37), where the mature seeds may contain several viable embryos. Although in some species adventive embryony is independent of pollination, there are others (probably including *Poncirus*) in which the embryos do not mature unless it occurs. In these instances the germinating pollen probably provides a chemical factor essential for continued growth. It is significant in this connection that in one orchid, *Zygopetalum machaii*, adventive embryony, although dependent upon pollination, is quite as effectively stimulated by pollen from another genus as by

that from the species itself. Multiple seedlings from normally one-seeded fruits are a feature of many tropical trees, and this suggests that apomixis may be widespread in the tropical rain forest.

The only remaining form of apomixis is more conspicuous since it involves the formation of bulbils or dwarf shoots in place of flowers. *Saxifraga cernua* and *Festuca vivipara* provide examples. Some species (e.g., *S. cernua*, Fig. 9.38) producing these structures are also able to reproduce in a normal sexual manner, bulbils being borne in the lower part of the inflorescence and flowers in the upper. In some grasses, and probably in other plants displaying this phenomenon, the way the plant reproduces can be influenced by the length of day in which it is grown.

Other forms of asexual reproduction are purely vegetative. Stems may arch over and root themselves, as in *Rubus*, and leaves of a number of species produce plantlets either at the summit of the petiole, as in *Tolmiea* (a frequent house plant), or marginally, as in *Kalanchoë*. Species which grow from bulbs usually reproduce themselves by the production of axillary buds at the base of the axis which develop into daughter bulbs. Corms multiply themselves by a similar process. Fleshy roots which are able to give rise to buds largely account for the success with which plants such as *Convolvulus arvensis* (bindweed) and *Lepidium draba* (hoary cress) are able to multiply themselves. In addition to these various forms of vegetative reproduction occurring in nature, layering,

Figure 9.38 *Saxifraga cernua*. (a)

Inflorescence with one normal flower and the rest developing as bulbils. (b) Germinating bulbil. (After Kerner von Marilaun and Oliver. 1902. *The Natural History of Plants*. Blackie, London.)

budding and grafting are frequently used in horticulture, and are the only means of propagating many valuable varieties whose sexual reproduction is defective. The protocorms of orchids (p. 297) transferred to aseptic culture will each yield several plantlets, providing a valuable technique, utilized commercially, for the propagation of rare species.

Most remarkable of all, perhaps, is that in experimental conditions isolated cells and even pollen grains will give rise to whole plants of normal growth and form. Those raised from pollen grains are particularly useful in breeding. They initially contain the reduced number of chromosomes, but this can be doubled by colchicine so that a pure homozygote is obtained which shows normal sexual reproduction.

The emergence of the angiosperms

The first angiosperms

As has been implied in the previous chapter, the origin of the angiosperms, in terms of an ancestral group, remains obscure. There is little doubt that their distant ancestry lies with the Lyginopteridopsida (p. 220). Recent cladistic studies point strongly to a common derivation with the Bennettitales (p. 252), Pentoxylales (p. 257) and Gnetopsida (p. 259), the last certainly approaching angiosperms more closely than any other group currently known. Together, these groups are sometimes referred to as the “anthophytes”, an expansion, to include the fossil representatives, of the older concept of the chlamydosperms, comprising solely the Gnetopsida. The search for the origin of the angiosperms now demands attention to the likely inter-

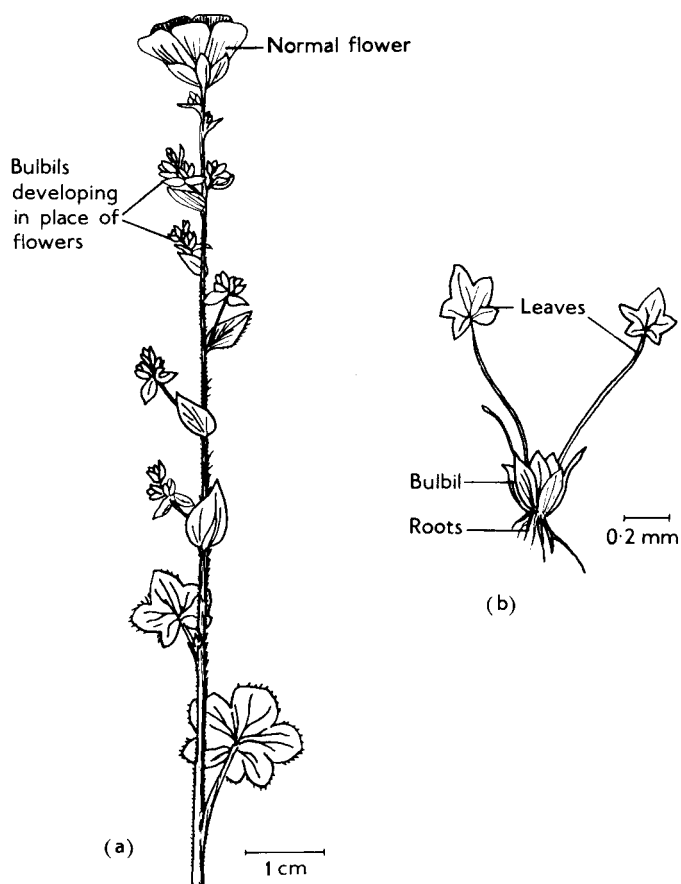

relationships of the anthophytes (Fig. 9.39), coupled with comparative molecular data from wide surveys of living Gnetopsida and angiosperms.

There are no simple criteria by which a fossil can be accepted as an angiosperm. Vessels, for example, are found in the Gnetopsida, and archegonia are absent from *Gnetum* and *Welwitschia*. The presence of a closed carpel and pollen tubes in stylar tissue are not readily demonstrated in fossil material. With the earliest fossils, angiospermous affinity has largely to be assessed by the extent of the resemblances to living forms. The position with regard to fossil pollen is fortunately clearer. Pollen with columellar exine (Fig. 9.40) is unknown outside the angiosperms, and there is no convincing evidence that fossil gymnosperms ever produced pollen of this kind.

Some have envisaged the angiosperms appearing in upland regions (and hence away from sites of fossilization) as early as the late Paleozoic, early

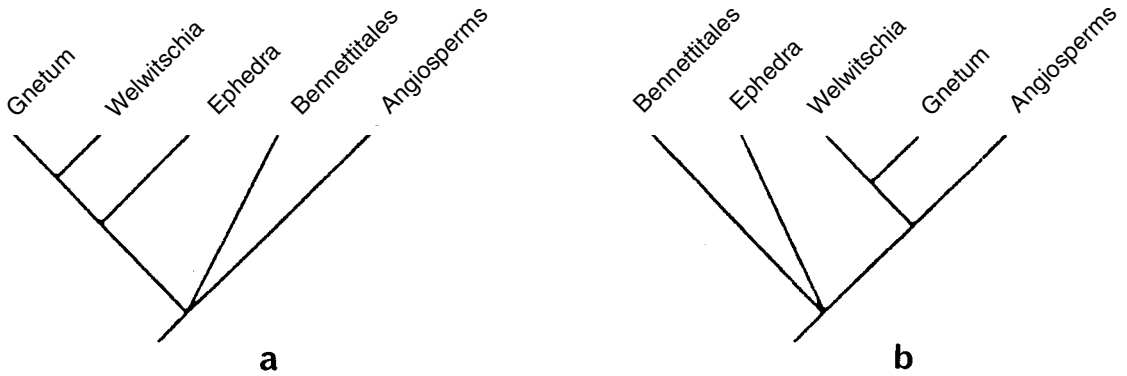

Figure 9.39 Two possible relationships of angiosperms with their closest relatives. (From Crane, Friis and Pedersen. 1995. *Nature* 374.)

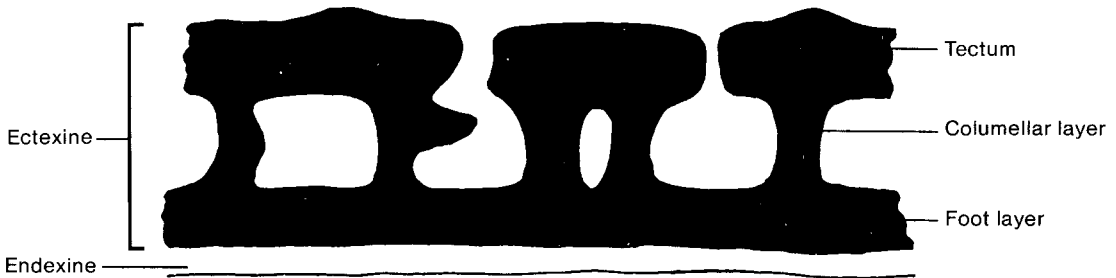

Figure 9.40 Diagram of a representative section of the exine of an angiospermous pollen grain, showing the thin endexine and the three layers of the ectexine. The exine covering the colpus is both thinner and simpler.

forms perhaps resembling *Sanmiguelia* (p. 257). The first specimens of angiosperm pollen are not, however, found until the Lower Cretaceous (Table 9.2). In view of the long distances over which pollen can be transported by wind and water, an origin of the angiosperms (as we perceive them today) before the Mesozoic seems unlikely.

Some of the oldest reproductive parts assigned to the angiosperms come from the Upper Jurassic and Lower Cretaceous. *Archaeofructus*, from the Upper Jurassic of China, is a reproductive axis bearing helically arranged fruits. These have been interpreted as being formed from conduplicate carpels (see, for example, Fig. 9.46). The branched fertile axis was subtended by two leaf-like structures. Although of probable angiospermous affinity, this plant is unlike any previously described. However, its overall morphology is in

keeping with a position in the Magnoliidae (see below). A diversity of angiosperm fossils has now been recovered from the Lower Cretaceous. They are mostly seeds and fruits, lacking structural preservation. Their resemblances to those of any living species are often too superficial to permit firm identification of their affinities. Nevertheless, all those that do have recognizable features have been found to be attributable to the existing subclass Magnoliidae of the Magnoliopsida, plants generally unspecialized in construction. Commonly the carpels are free, and the floral parts are spirally arranged and often poorly differentiated into petals and sepals (as in *Magnolia* itself). The subclass also contains plants with very simple flowers which tend to be clustered in spikes (e.g., *Piper*, pepper). These plants are commonly not woody. It would seem that these early angiosperms comprising the Magnoliidae gave rise to the remainder of the Magnoliopsida (sometimes referred to as the “eudicots”) and the entire class Liliopsida (Fig. 9.41).

Table 9.2 Stages of the Cretaceous.

		Age (10 ⁶ years)
Danian (Early Paleocene)		65
Late	Maastrichtian	
	Campanian	
	Santonian	
	Turonian	
	Cenomanian	
		97
Early	Albian	
	Aptian	
	Barremian	
	Hauterivian	
	Valanginian	
	Berriasian	
<div style="display: flex; justify-content: space-around; align-items: center;"> <div style="text-align: center;"> <p>Neocomian</p> <p>↑</p> <p>↓</p> </div> <div style="text-align: center;"> <p>Wealden Beds (freshwater)</p> <p>↑</p> <p>↓</p> </div> </div>		
		145.6
Late Jurassic		

Notes:

Time scale based on W. B. Harland *et al.* 1989. *A Geologic Time Scale*. Cambridge University Press, Cambridge.

Later in the Lower Cretaceous (in rocks of Aptian and Albian age) are found flowers with free carpels, and fruits with small seeds evidently produced from anatropous ovules. Bisexual flowers with their parts in a spiral arrangement have also been reported. Leaves with angiosperm-like venation, already known from pre-Albian rocks, also become more numerous and varied at this time.

Magnolia-like fossil flowers have supported the view, long held by those studying living angiosperms, that the Magnoliidae are primitive. Nevertheless, it is the less spectacular remains of stamens and tiny, apetalous flowers from the early Cretaceous that are attracting particular attention. They are giving rise to the view that the earliest angiosperms bore small, trimerous flowers reaching 2 mm (0.08 in.) or less in length. The stamens generally had valvate dehiscence, and the carpels a poorly developed stigmatic surface. Such fossilized flowers (Fig. 9.42) have been found in early Cretaceous deposits in Portugal and North America. In life many of these flowers must have resembled those of living peppers (Piperaceae) and Chloranthaceae, and the plants that bore them have been referred to as "paleoherbs". Others were like those of *Ceratophyllum* (hornwort,

not to be confused with the bryophyte *Anthoceros*, p. 115), at the present time a wholly aquatic genus. Yet others resembled the flowers of laurel (*Laurus*) and the related genus *Calycanthus*. All these would be referable to the Magnoliidae. Many of these early flowers were unisexual.

Derivation of the Liliopsida

The recognition that small, trimerous flowers might be the most primitive within the Magnoliidae has thrown new light on the likely source of the Liliopsida. The preponderance of the trimerous state in this subclass can be attributed to the retention of an ancient feature, and the concept of its having been derived by reduction from the relative complexity of the *Magnolia*-like flower need not be invoked. In addition, the lack of woodiness in the Liliopsida can be regarded as a retained primitive characteristic. Cladistic analyses, utilizing data from nucleotide sequences in the plastid gene *rbcL*, as well as other molecular and morphological features from a wide range of monocotyledons, point to *Acorus* (sweet flag), long regarded as belonging to the Araceae, as the most primitive form of living Liliopsida. Present evidence would therefore suggest that an ancestral

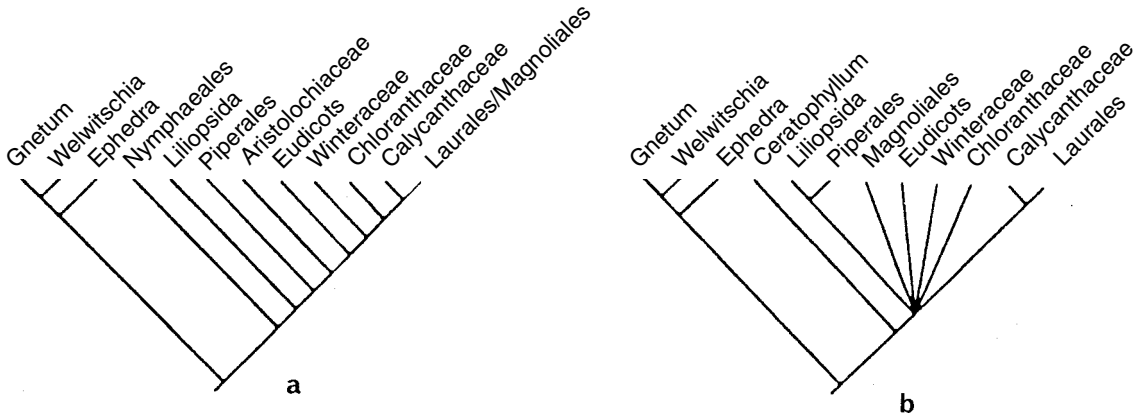

Figure 9.41 Two cladistic analyses depicting possible relationships amongst primitive angiosperms. These analyses have utilized morphological information combined with sequence data from (a) ribosomal RNA and (b) the *rbcL* plastid gene. (After Doyle, Donoghue and Zimmer. 1994. *Annals of the Missouri Botanical Garden* 81, and Albert, Backlund, Bremer et al. 1994. *Annals of the Missouri Botanical Garden* 81, respectively.)

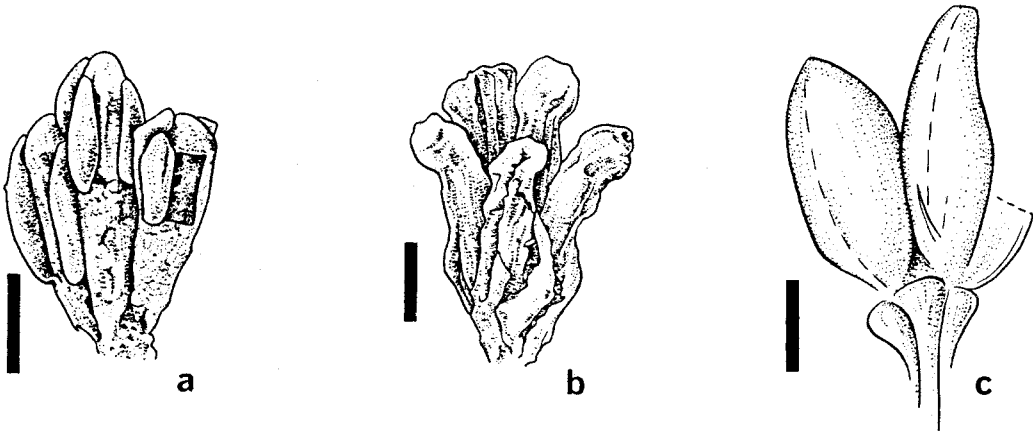

Figure 9.42 Early simple angiospermous flowers of the Magnoliidae. (a) *Chloranthus*-like androecium with three stamens. Scale bar 0.2 mm. (b) *Platanus*-like female flower with five free carpels. Scale bar 0.2 mm. (c) Fruit consisting of three follicles borne on a receptacle. Scale bar 2 mm. (After Friis and Crepet, from Friis, Chaloner and Crane (eds.) 1987. *The Origins of Angiosperms*. Cambridge University Press, New York.)

form was to be sought amongst the paleoherbs, or perhaps some early representatives of the magnoliid family Aristolochiaceae (birthworts), all currently herbaceous and with trimerous flowers. Flowers which can be confidently ascribed to the

Liliopsida have been found in the Upper Cretaceous Turonian (Table 9.2). They resemble those of the living Triuridaceae, currently a tropical family of small saprophytes.

The fossil record gives little information about the diversification of the early Liliopsida paralleling that in the Magnoliopsida. However, by the late Cretaceous, fruits of ginger-like plants and leaves and stems of palms are found. The earliest grasses were probably bamboo-like. Remains of grasses appearing referable to the Poaceae, the most important liliopsid family of temperate agriculture, are found in Eocene deposits (Fig. 9.43).



Figure 9.43 A grass-like liliopsid (Poaceae) node with sheathing leaf base and adventitious roots. Eocene age, from the Green River Sandstone, Colorado, USA. Scale bar 1 cm.

Diversification of the early Magnoliopsida

Current evidence clearly points to the earliest Magnoliopsida being represented by plants showing affinities with the living Magnoliidae. Diversification of these early forms evidently gave rise to the “eudicots” (p. 303). Unisexual flowers in catkin-like inflorescences, resembling those of living *Platanus* (plane), can be recognized by the Albian stage of the mid-Cretaceous, as can other simple flowers (e.g., *Caloda*) reminiscent of the subclass Hamamelididae, a group containing most of the wind-pollinated forest trees (Fig. 9.44). Simultaneously, net-veined leaves became more common (Fig. 9.45), and angiospermous pollen grains more abundant.

At the beginning of the Upper Cretaceous (Cenomanian) the frequency and diversity of angiosperm remains increase substantially.

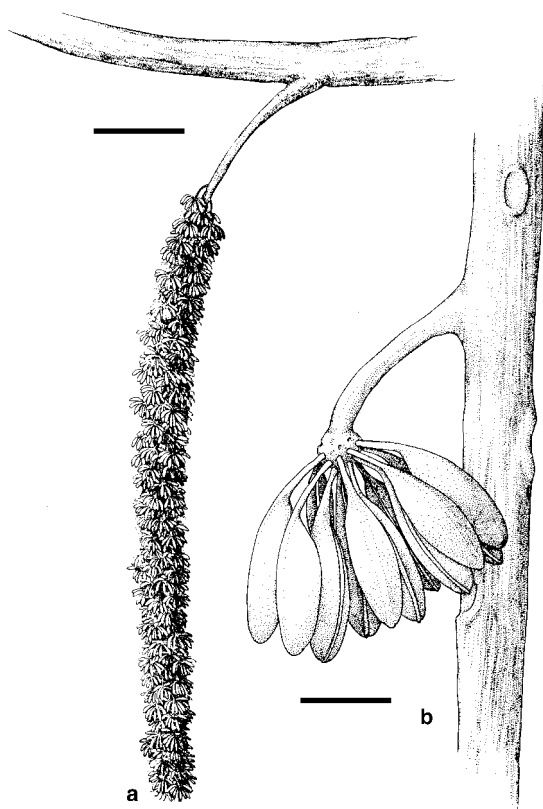

Figure 9.44 *Caloda*. The female axis (a) bears many short branches. Each short branch terminates in a cluster of carpels (b). The precise relationships of this fossil remain obscure, but it would appear to be basal within the Hamamelididae, perhaps close to the Platanaceae. Scale bars: (a) 1 cm; (b) 2 mm. (From Dilcher and Kovach. 1986. *American Journal of Botany* 73.)

Many of the leaves and flowers begin to resemble those of modern genera. A reconstruction of *Archaeanthus* (Fig. 9.46), for example, shows numerous conduplicate carpels borne spirally on the terminal portion of a robust axis. Below these were three regions of dehiscence scars that probably represent the positions of stamens, perianth segments, and bud scales or bracts. Flowers with a cyclic arrangement of the floral parts also appear in the fossil record by the mid-Cretaceous (Fig. 9.47), some with syncarpous gynaecia.

By the late Cenomanian, flowers with inferior ovaries are also found. Although many of the mid-Cretaceous flowers remain unfamiliar, a number of living families, amongst them the

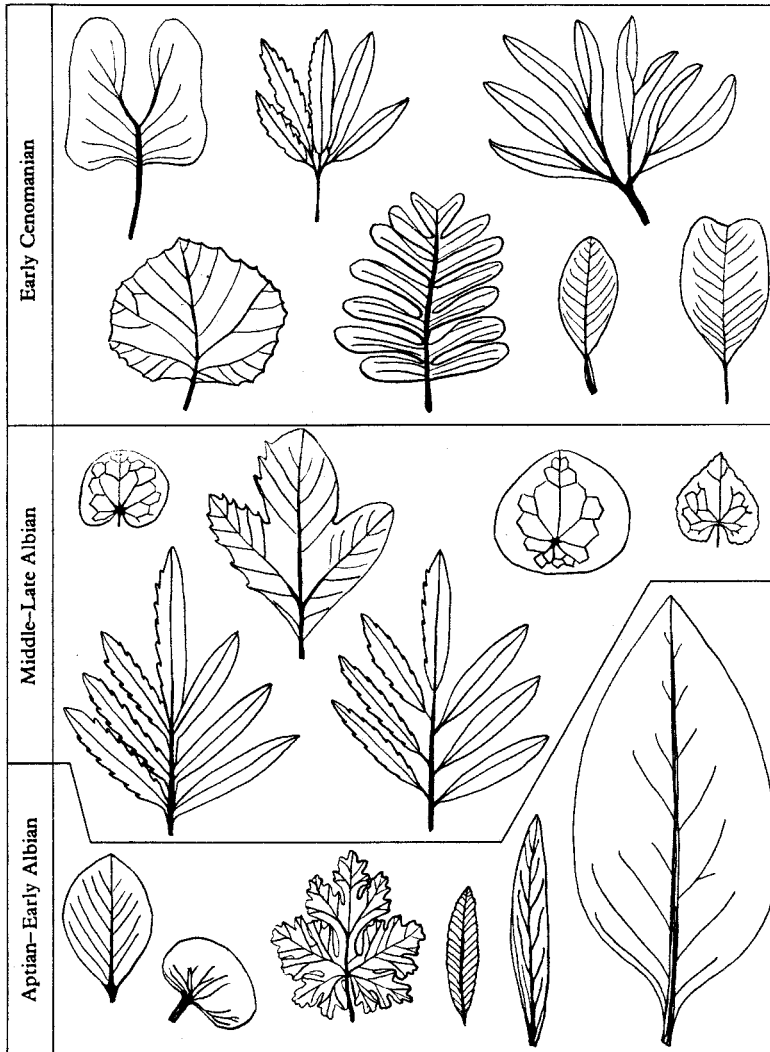

Figure 9.45 Leaf fossils from progressively younger beds of the mid-Cretaceous, showing a tendency toward increasing morphological complexity. (From Upchurch and Wolfe, in Friis, Chaloner and Crane (eds.) 1987. *The Origins of Angiosperms*. Cambridge University Press, New York.)

more hazardous. Nevertheless, *Amborella*, a shrubby angiosperm of New Caledonia, related to the laurels and other Magnoliidae (p. 303), has been claimed as an example of an angiosperm least altered from the concept of the ancestral flowering plant. Like all characters involved in cladistic analysis, DNA sequences may be subject to changes in evolution which reverse previous character switches. This can give rise to bizarre results, and presumably lead to cladograms in which, for example, *Selaginella* occurs among the ferns, and in a clade separate from *Isoetes* and *Lycopodium* (*Huperzia*) (Chapter 6). The rationality of such an arrangement cannot be sustained on

Magnoliaceae, Platanaceae and Winteraceae, can now be clearly recognized.

The technique of sequence analysis applied to the DNA of selected living angiosperms has led to numerous cladograms detailing degrees of relationship between the chosen specimens. Since this form of analysis also incorporates a concept of primitiveness (derived by comparison with a more distantly related plant, such as a fern), these studies are also capable of indicating likely ancestral genetic configurations. Generally, such investigations produce consistent results with regard to the relationships within large groupings, such as the Liliopsida and the “eudicots” (p. 303), but firm recognition of the most primitive form is

any reading of the morphological evidence, living or fossil. Despite the features of *Amborella* being in a number of respects undeniably primitive, to claim it as a “living fossil” would, on present evidence, be quite unwarranted.

Evolution of morphological features within the angiosperms

Origin of the carpel

There is little direct evidence of the origin of the carpel. It is, however, significant that in *Drimys* (Fig. 9.48) and *Degeneria* (Fig. 9.49), both within the extant Magnoliidae, the carpel is a clearly conductive structure with a lateral stigma lying along

Figure 9.46 Reconstruction of a flowering shoot of the magnoliaceous Cenomanian (mid-Cretaceous) plant *Archaeanthus*. The deeply divided leaves are unlike those of any living magnoliaceous plant, but there is an approach to this condition in *Liriodendron* ("tulip tree") of North America and China. (After Dilcher and Crane. 1985. *Annals of the Missouri Botanical Garden* 71.)

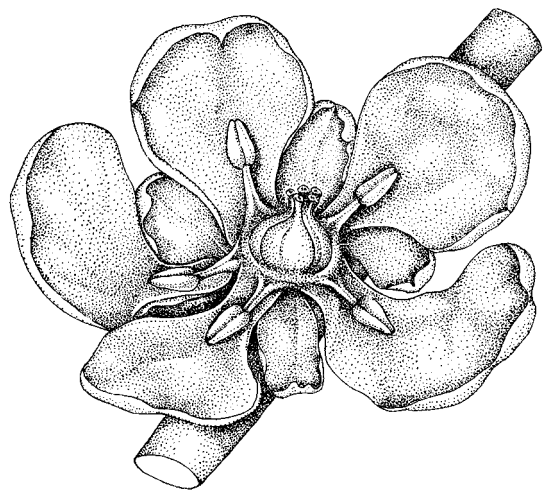
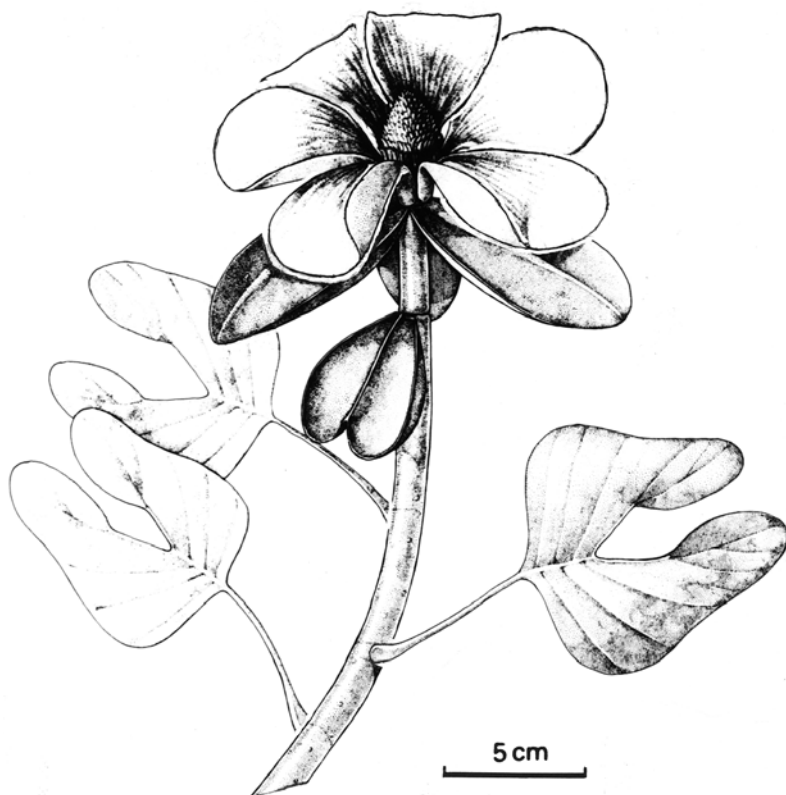

Figure 9.47 Reconstruction of a mid-Cretaceous (Dakota Formation) pentamerous flower with features of the Rosidae. The flowers were 25–40 mm (1–1.6 in.) in diameter. (After Basinger and Dilcher. 1980. *Botanical Society of America, Miscellaneous Series* 158, from Stewart and Rothwell. 1993. *Paleobotany and the Evolution of Plants*, 2nd edn. Cambridge University Press, New York.)

part or the whole of the ventral suture. In *Degeneria* the ventral margins of the carpel do not even fuse (Fig. 9.49), but become interlocked by hairs between which the pollen tubes force their way.

It is clear that many gymnospermous structures approach the carpel in form, notably those of the Glossopteridales (p. 255) and corytosperms (p. 254). Continuation of the developmental trends seen in the ovule-enclosing structures of the corytosperms (pp. 256, 257) could have led with little further modification to the angiospermous carpel. This would have required, of course, the ability of the gametophytic pollen tube to grow freely through the sporophytic tissue to the embryo sac. The tendency for gametophytic and sporophytic tissues, when in contact in the life cycle, to be separated by isolating barriers (well seen in bryophytes (p. 103) and ferns (p. 208)) is modulated in many angiosperms by the presence of incompatibility systems (p. 296). These depend upon successful pollination being possible only when the genomes of the sporophyte and pollen differ in

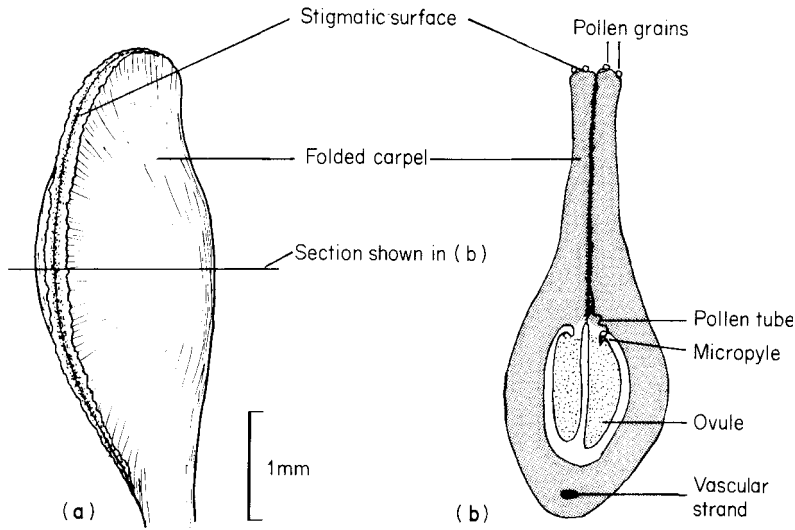

Figure 9.48 *Drimys piperita*. (a) Carpel with stigmatic surface along the ventral suture. (b) Transverse section of carpel. (After Bailey and Swamy, from Foster and Gifford. 1959. *Comparative Morphology of Vascular Plants*. Freeman, San Francisco. © 1959.)

dissimilar genome. This continued accessibility was an essential prerequisite for the evolution of angiospermy. The outbreeding enforced by incompatibility systems would also have tended to promote the establishment of

new forms, and probably contributed substantially to the apparently rapid diversification of the flowering plants in the late Mesozoic. The impression, arising from the occurrence of self-incompatibility in the living representatives of many of the families to which some of the earliest angiosperms can be confidently assigned, and from the features of much of early Cretaceous pollen, that the emergent angiosperms were indeed self-incompatible is becoming increasingly acceptable. It would follow that self-compatibility in flowering plants was a derived feature.

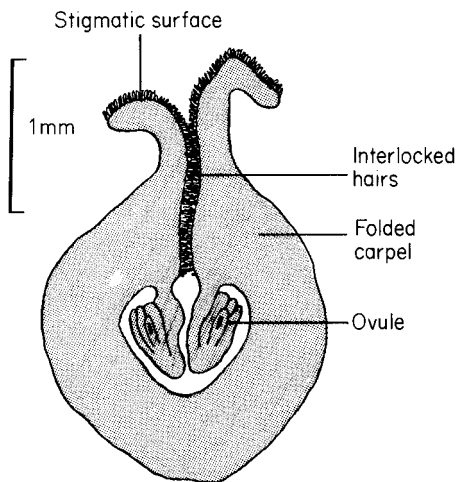

Figure 9.49 *Degeneria* sp. Transverse section of conduplicate carpel. The ventral lobes, although appressed, do not fuse, but become interlocked by hairs. The flared ventral margin provides a stigmatic surface. (After Swamy, from Foster and Gifford. 1959. *Comparative Morphology of Vascular Plants*. Freeman, San Francisco. © 1959.)

respect of alleles of certain incompatibility genes. This genomic difference prevents the activation of defense reactions in stigma and style. Consequently only outbreeding is possible. Heterozygosity is thus maintained and the continuance of the system in successive generations ensured. Incompatibility systems allow the closing of the carpel while retaining the accessibility of the ovule to pollen tubes with an appropriately

The woody habit

Although comparative analysis of living floras indicates that the woody habit is correlated with reproductive features we can now recognize from the fossil record as primitive, it should be noted that woody plants generally reproduce less rapidly than herbaceous, thus limiting the rate of evolutionary advance. Woodiness is predominant amongst gymnosperms of the late Paleozoic and Mesozoic, a possible exception being *Sanmiguelia* (p. 257). Certainly some of the earliest angiosperms were woody, but, equally, herbaceous paleoherbs were also amongst the earliest forms. Shrubby forms may have evolved from herbaceous in the Lower Cretaceous, and conversely shrubby *Archaeanthus*-like plants may have given rise to herbaceous forms in mid-Cretaceous times. In general, woodiness does not seem to have been a feature of early to mid-Cretaceous vegetation, and remarkably little angiosperm wood has been

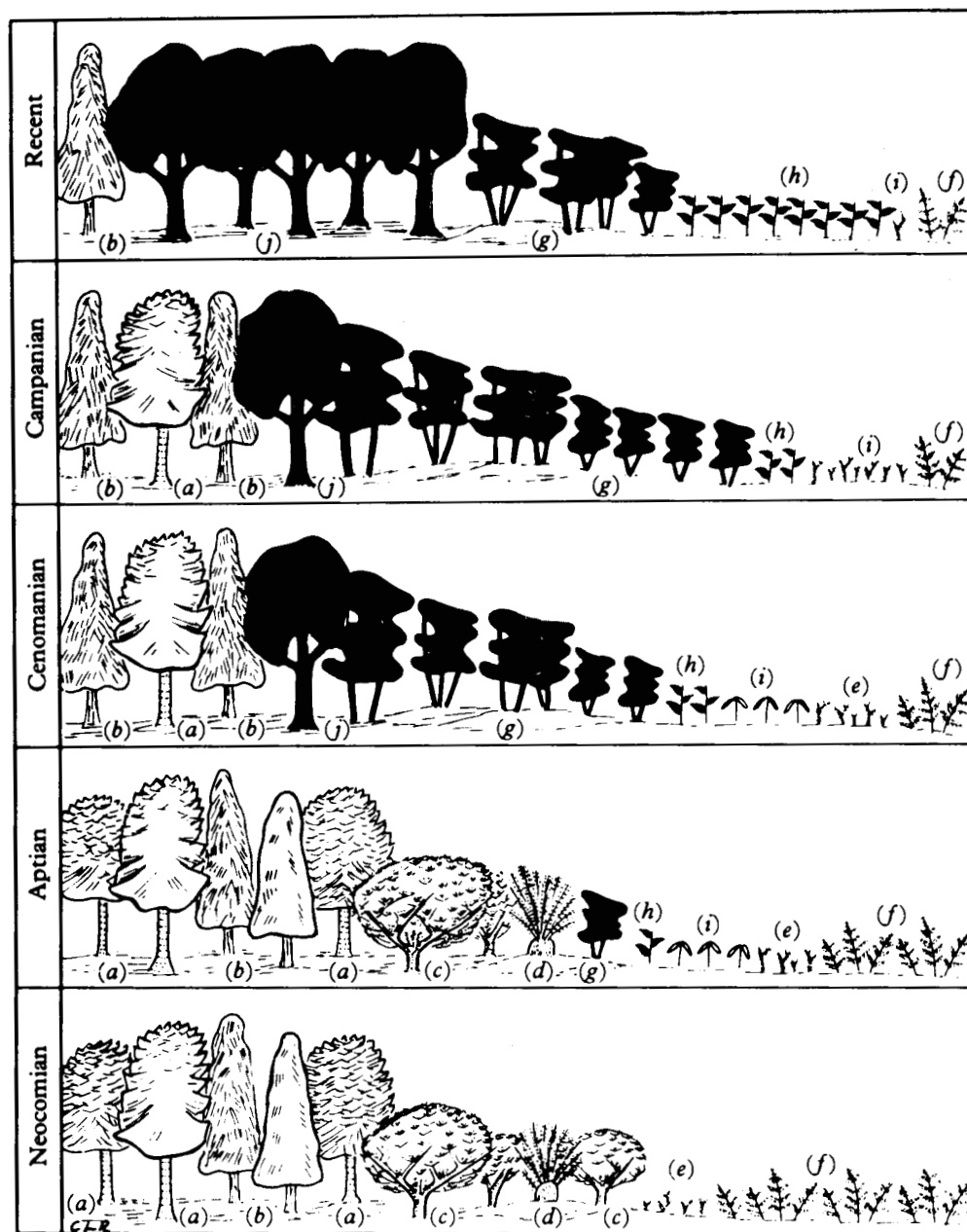

Figure 9.50 Diagram showing the changing composition and form of the Earth's vegetation during the Cretaceous period. The current climax vegetation at middle latitudes is included for comparison. (a) Araucarian conifer. (b) Taxodiaceous conifer. (c) Cycadalean shrub. (d) *Cycadeoidea*-like bennettitalean. (e) Herbaceous lycopod. (f) Fern. (g) Angiosperm shrub. (h) Angiosperm herb. (i) Gnetalean herb or small shrub. (j) Angiosperm tree. (After Crane, from Friis, Chaloner and Crane (eds.) 1987. *The Origins of Angiosperms*. Cambridge University Press, New York.)

found of Cretaceous age. Massive trees, such as occur in the tropical rain forest, probably first appeared in the Upper Cretaceous (Fig. 9.50).

Xylem

Although the secondary xylem of a particular species of angiosperm has a characteristic anatomy, within the angiosperms as a whole there is considerable variation in such features as the length of vessel segments and the form of

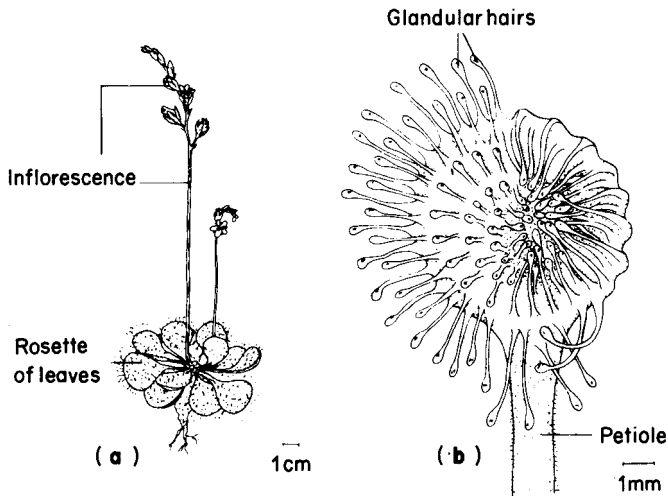

Figure 9.51 *Drosera rotundifolia*.

(a) Habit. (b) Single leaf in which some of the glandular hairs have closed on an entrapped insect. (After Kerner von Marilaun and Oliver. 1902. *The Natural History of Plants*. Blackie, London.)

buds (p. 301), many pinnate leaves are hardly distinguishable from lateral shoots of limited growth, bearing leaves in a single plane. In *Chisocheton*, a tree of Southeast Asia with a large pinnate leaf, the apex of the main rachis

perforation and orientation of the end plate. These features vary independently of each other, but statistical analysis has revealed that two combinations appear significantly frequently. Long vessel segments (1.3–2.0 mm; 0.05–0.08 in.), for example, tend to be associated with obliquely placed end plates with scalariform perforations, and short segments with transverse end plates with single large pores (see Fig. 9.10). Long vessel segments are also associated with a number of other features, such as the angularity of the outline in transverse section, small cross-sectional area and uniform thickening of the walls. Vessel segments of this kind closely resemble the tracheids of divers gymnosperms, such as *Callixylon* (*Archaeopteris*), pines and *Ginkgo*. Long vessel segments might be expected to characterize the xylem of the Magnoliidae generally. The wood of *Drimys*, also placed with the Magnoliidae, lacks vessels altogether and consists wholly of gymnosperm-like tracheids. Short vessel segments may have been a feature of the paleoherb ancestors (perhaps in the form with which they occur in living Liliopsida). They may also have arisen independently (as in the Gnetopsida).

Leaves

Although little can be said with certainty concerning the evolution of leaves, there are many indications of stem-like properties in the leaves of angiosperms, indicating their affinity with megaphylls (p. 172) rather than microphylls (p. 150). Apart from the stem-like branching of some leaves (p. 277) and the readiness of others to yield shoot

remains active for several seasons, producing a pair of pinnae annually. The leaves of the related tropical shrub *Guarea* behave in a similar way and the leaf may continue to grow for as long as 10 years. Inbreeding may also reveal the developmental similarity of stems and leaves. In some improved varieties of tomato, for example, buds arise freely along the rachis of the leaf, and the distal part often continues growth as a shoot.

Comparatively recent evolution in the form of leaves has evidently been concerned in some instances with modification for a particular function. The insect traps of *Drosera* (sundew) (Fig. 9.51), *Nepenthes* (pitcher plant) (Fig. 9.52) and *Dionaea* (Fig. 9.53) are examples of this kind of development. Sometimes evolution has been in relation to, and perhaps coupled with, that of a particular insect, usually a species of ant, which lives in and is nourished by the plant concerned. In several tropical species of *Acacia*, for example, the long thorn-like stipules are hollow and provide shelter, while the leaflets terminate in small globules of parenchyma (Belt's corpuscles) which are devoured by the ants (Fig. 9.54). Succulence of leaves (the anatomical and physiological modification of the mesophyll enabling it to retain large quantities of water) also reaches its highest development in the angiosperms and is a feature of many desert and maritime species.

Flowers and inflorescences

The fossil evidence (p. 303) points to the first angiosperm flowers having had the members of both the sterile and fertile parts of the flower separate

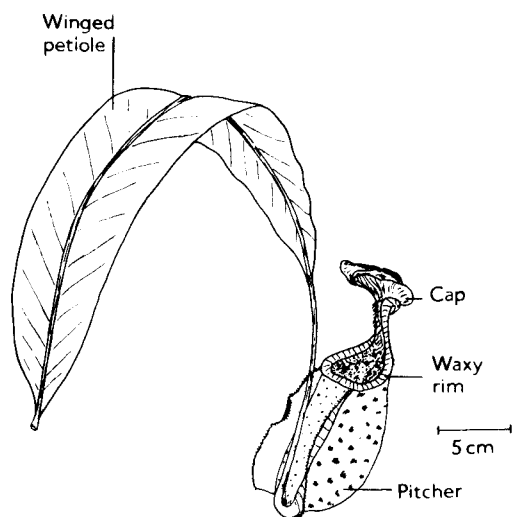

Figure 9.52 *Nepenthes*. Leaf modified to form a pitcher-like insect trap. The inner surface of the pitcher is covered with tile-like plates of wax making it impossible for the insect to climb out. (After *Botanical Magazine*, from Wettstein, 1935. *Handbuch der Systematischen Botanik*. Deuticke, Leipzig.)

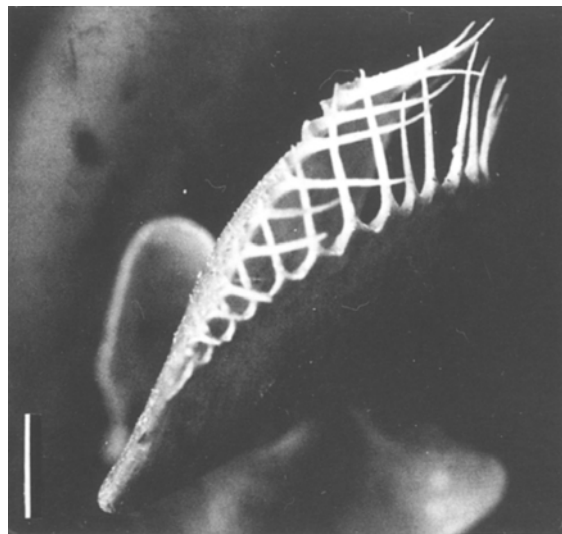

Figure 9.53 *Dionaea muscipula* (Venus flytrap): an insectivorous plant in which the leaf is highly modified. The terminal lamina of the leaf is in two halves which rapidly close together when the sensitive hairs on the surface are touched, the marginal teeth interlocking. Entrapped insects are digested by proteolytic enzymes coming from glandular hairs on the inner (adaxial) surface of the lamina. Scale bar 2 mm.

from each other. In present-day floras such *chorichlamydeous* flowers are found not only in primitive woody species, but are also characteristic of such families as the herbaceous Ranunculaceae and the monocotyledonous Alismataceae. Nevertheless, congenital fusion of parts (which rarely involves actual fusion, but is a consequence of the delayed appearance of separated meristems in development), both of the perianth and of the reproductive region, can be looked upon with fair certainty as a later feature in the evolution of the flower. As we have seen with the algae (Table 3.1), simple and presumably earlier features can continue to exist together with the more complex provided the organisms concerned continue to fill an ecological niche and their attributes are not selectively disadvantageous.

Quite apart from fusion of parts within the flower, another tendency, clearly evident in some alliances, has been toward the evolution of compact inflorescences. The ultimate form of such an inflorescence is the dense capitulum, occurring in a number of families, but characteristic of the Asteraceae (Compositae). In many instances, owing to the differentiation of disk and ray florets, capitula have come superficially to resemble simple flowers, a feature well shown by the common daisy, *Bellis perennis*. In *Syncephalanthia*, a Central American composite, we even find a racemose aggregate of capitula which, taken as a whole, also has a flower-like form owing to the asymmetry of the marginal capitula. The sporadic occurrence of these flower-like inflorescences in a number of families indicates that the radiate form of the reproductive region, whatever its composition, has biological significance. Natural selection would account for the repeated emergence of this pattern despite the increasing morphological complexity of the reproductive region.

The evolution of spurred and otherwise zygomorphic petals, distinctive scents, nectaries and peculiar stamens (see p. 285) and striking pigmentation of the perianth are all usually associated with insect (and rarely bird) pollination. Sometimes the life cycles of both plant and insect are so closely interwoven that one could not exist without the other. Reproduction in the figs (*Ficus*) provides a particularly striking example. Here evolution has led to an urn-shaped receptacle, almost

Figure 9.54 *Acacia sphaerocephala*.
Portion of leaf showing the hollow
stipules and Belt's corpuscles.

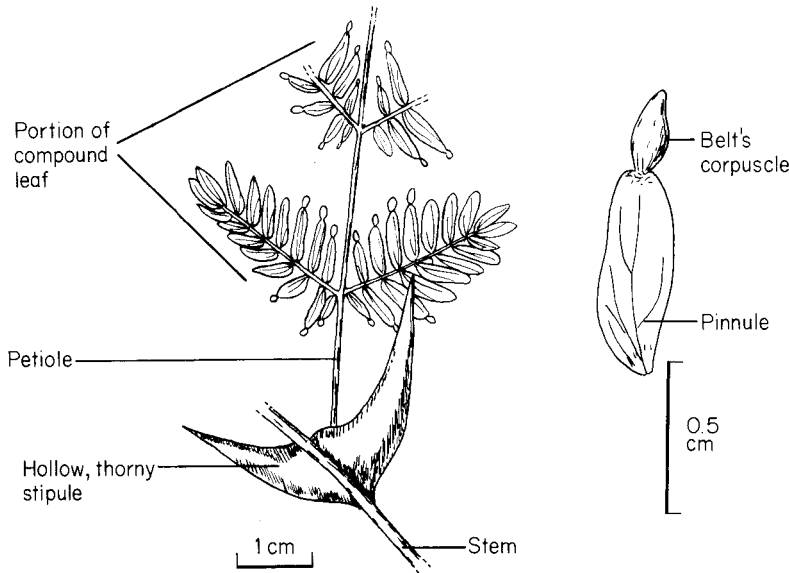

physiological adaptation to extreme habitats. In the salt marsh plant *Limonium* (sea lavender), for example, glands on the leaves actively excrete the excess ions taken up with the soil water. In a number of angiosperms evolution has led to the abandonment of autotrophy, the species concerned becoming in consequence obligate heterotrophs, a transition already seen in other divisions of the plant kingdom. Examples amongst

closed at the mouth. The female flowers, the first to open in the cavity of the receptacle, are pollinated by particular wasps which force their way through the narrow entrance and bring in pollen from elsewhere. Eggs are laid in some of the ovaries and the emergence of the new generation of wasp coincides with the opening of the male flowers. In escaping from the fruit they take pollen with them and the cycle is repeated in another developing fruit. In some species the cycle is even more complicated, two species of wasp being involved. These situations raise profound problems of evolution, since at some stage flower and insect must have begun to evolve together, leading ultimately to complete mutual dependence.

The inflorescences of the Araceae, in which the small individual flowers are crowded on a rod-like spadix surrounded by a tent-like spathe, are remarkable for the heat generated as the flowers mature. This is brought about by vigorous respiratory activity in the spadix. The high temperature (as much as 30 °C (54 °F) above that outside the spathe) vaporizes unpleasantly smelling compounds which attract pollinators.

Physiology

It is evident that morphological diversification in the angiosperms has been accompanied by physiological. Apart from the wide range of secondary metabolites in angiosperms are many instances of

the angiosperms are provided by *Epipogium*, an orchid which lacks chlorophyll and derives its nutrition from a highly developed mycorrhiza, and such parasites as *Lathraea* (toothwort), *Orobanch*e (broomrape) and *Cuscuta* (dodder) (Fig. 9.55). A number of angiosperms, such as *Viscum* (mistletoe), *Euphrasia* (eyebright) and *Striga* (a pest of *Sorghum* in the semi-arid tropics), have become parasitic without losing the ability to photosynthesize, so they are not entirely dependent upon their hosts.

Penetration of the host is accomplished in a number of different ways. In *Viscum*, the seed germinates in the bark of the host tree, the root enters the cortex, ramifies, and haustoria are formed with the vascular system of the host. In *Cuscuta*, the seeds germinate in the soil, but the seedlings make wide circumnutatory movements. Some achieve contact with the host. The parasitic stem then twines tightly about the host branch, making about three turns (rarely more) before growing further. At the points of contact protuberances develop and form haustoria within the host. In the South African root parasite *Hyobanche*, the haustoria develop from young scale leaves of the subterranean rhizome of the parasite. When a leaf primordium touches a young root of the host, the site of contact begins to swell, and the distal part of the host rootlet dies. Haustoria grow into the swelling of the host root from the site of the leaf of the parasite.

Figure 9.55 *Cuscuta*. (a) Habit. (b)

Transverse section of host stem showing the penetration of the vascular tissue of the parasite into that of the host. ((a) after Kerner von Marilaun and Oliver. 1902. *The Natural History of Plants*. Blackie, London.)

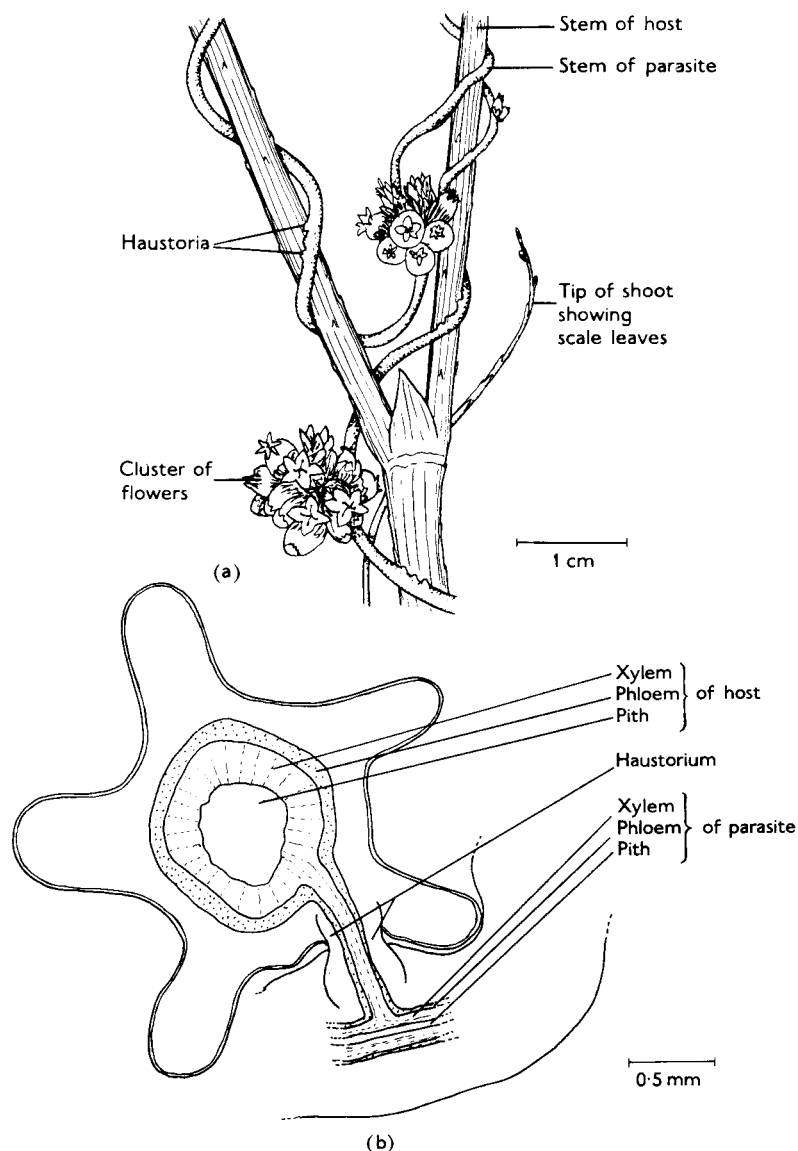

Recent evolution within families and genera

Knowledge of recent evolution in the angiosperms has come principally, as with the ferns, from studies of chromosome pairing in hybrids, often produced under experimental conditions. Hybridization of diploid species, followed by allopolyploidy, appears to have been the origin of a number of well-known plants, amongst them *Spartina anglica* (cord-grass) and *Galeopsis tetrahit* (hemp nettle). Observations of chromosome size may assist in assessing evolutionary relationships

of a wider character. The family Commelinaceae, for example, includes some genera in which the chromosomes are small, others in which they are strikingly large, and yet others in which the nuclei contain chromosomes of both sizes. Fossils have contributed little to knowledge of this kind of evolution. A few fossil series of recent age are known, mostly of angiospermous seeds, but they indicate little other than minor changes in structure and shape. Seeds of the water plant *Stratiotes* (water soldier), for example, are found in successive strata throughout the Tertiary era. There was

evidently a slight, but progressive, lengthening and narrowing of the seed during this period, together with minor changes in the relative development of the parts.

Comparative biochemistry can also reveal affinities of living plants and indicate possible lines of evolution. The grouping of species in *Aesculus* (buckeye), for example, is assisted by the occurrence in some species of distinctive non-protein amino acids and their absence in others. Isozyme analysis can also indicate evolutionary pathways within genera. The constitution of chloroplast DNA has also been subject to evolutionary change in recent time. Restriction enzyme analysis of chloroplast DNAs from both liliopsids and magnoliopsids has assisted in elucidating phylogenetic relationships within genera and families.

The lead- and copper-tolerant forms of the grasses *Agrostis tenuis* and *Festuca ovina*, found on spoil heaps of old mines, are splendid examples of recent evolution. This is generally considered to have occurred by selection of resistant mutants appearing spontaneously in natural populations. Species tolerant of normally toxic concentrations of various heavy metals are found in a wide range of angiosperm families. The metal ions are usually removed from the general metabolism by complexing with specific amino acids or proteins. The latex of *Sebertia acuminata* (Sapotaceae), a small tree endemic to New Caledonia, has been found to contain up to 11 percent of nickel, its toxicity suppressed by its forming a complex with the amino acid histidine. Plants which show this kind of hyperaccumulation often serve as "indicator plants" to those prospecting for ores of copper, nickel and other metals. They may also provide a means of extracting valuable metals from low-grade sources. Plants of Indian mustard (*Brassica juncea*), for example, growing on soils rich in particulate gold, will, if the gold is solubilized by adding ammonium thiocyanate to the substrate, take up the metal freely. Although the thiocyanate eventually kills the plants, the gold can be recovered by burning the dead plants and extracting it from the ash. Such "phytomining" may have a commercial future.

The main trends of angiosperm evolution

To summarize, we can envisage the main evolutionary trends in the angiosperms to have been as follows. They emerged from the gymnosperms, probably, in view of the radial symmetry of the ovules and certain anatomical similarities, from a group evolving from the Lyginopteridopsida of the late Paleozoic. The angiosperms thus inherited a seed habit of long standing, and a serviceable form of axial structure in which lateral branch systems had long ago become megaphylls, and in which megaphylls in turn were becoming differentiated into petioles and laminae with reticulate venation. They improved upon this structure, replacing coarse and angular ramification by elegant branching. Anatomically, strengthening tissues tended to become reduced to those required by mechanical laws, and stems and branches consequently acquired a pliancy that is a protection against storms. Vessels were also developed from tracheids, and a more highly organized phloem containing sieve tubes and companion cells from simple sieve cells and parenchyma, both developments probably having advantageous physiological consequences. The reproductive regions became highly specialized, their evolution often being correlated with that of pollinating organisms.

Some have suggested that the angiosperms had more than one origin, i.e., that they, like the gymnosperms, may be polyphyletic. This, however, seems unlikely in view of the general occurrence of the characteristic "double fertilization" in the embryo sac. Nevertheless, the relationship between some Liliopsida, especially the palms, and the Magnoliopsida certainly appears remote, and we must assume that these two classes have followed more or less parallel lines of evolution for a considerable period.

We have considered both the herbaceous and the woody habits to have been present in the earliest angiosperms (p. 309). The subsequent evolution of the herbs was undoubtedly influenced by their interaction with grazing animals, and the establishment of angiospermous forests. In tropical regions many herbaceous angiosperms (e.g., Orchidaceae and Bromeliaceae) are in fact epiphytes upon angiospermous trees and shrubs, and it seems clear that these epiphytes followed rather

than preceded the arboreal vegetation. Because of the rapidity with which the relatively succulent leaves of angiosperms decay in tropical conditions, humus is soon formed wherever they accumulate. Consequently, fertile substrata are found in abundance on horizontal surfaces and in the crotches of branches. This leads to an ecological situation different from that in gymnospermous forests, where the leaves mostly reach the ground and the humus, owing to the slow decay of the leaves, is covered by harsh and unconsolidated material unfavorable for the establishment of delicate herbaceous forms. It thus seems reasonable to suppose that the epiphytic angiosperms (and ferns) emerged in response to, and are in the process of exploiting, the new ecological habitat created by the rise of the angiosperm forests. Their evolution would then have been, in geological time, a relatively recent event.

Today the angiosperms in some way resemble successful individuals reaching affluent middle age, determined to let no human experience escape them. They experiment freely with metabolic novelties, such as fragrant oils, peculiar alkaloids and unusual carbohydrates (such as the fructosan inulin). In sexual reproduction, as regards both pollination and the cytology of the

gametophytes, they show sometimes bizarre variations. We probably witness the angiosperms at the height of their success. It is difficult to envisage their being supplanted by any other form of vegetation. Nevertheless, the interdependence of the plant and animal kingdoms, sharing a common environment, itself subject to change, may lead to surprising developments. Under the hand of man, for example, the cereal grasses have been so modified and "improved" that some are now unable to reproduce effectively without human intervention. Despite this apparent failing, they none the less occupy large areas of fertile land, and from that point of view are far more successful than they might otherwise have been. Such dependence of one species on another, like the specialized forms of insect pollination, naturally has risks. Nevertheless, the progressive failure of one partner may stimulate novel developments in the other that ensure its survival. We can be confident that, so long as the photosynthetic membrane, solar radiation and the atmosphere (providing carbon dioxide) continue their existence, there is no reason why the evolution of plants should cease. Many more remarkable forms may yet emerge in geological time.