

SALICYLIC ACID

A Plant Hormone

Edited by
S. Hayat and A. Ahmad



 Springer

SALICYLIC ACID: A PLANT HORMONE

SALICYLIC ACID: A Plant Hormone

Edited by

S. Hayat

*Department of Botany
Aligarh Muslim University
Aligarh 202002, India*

and

A. Ahmad

*Department of Botany
Aligarh Muslim University
Aligarh 202002, India*

 **Springer**

A C.I.P. Catalogue record for this book is available from the Library of Congress.

ISBN-10 1-4020-5183-2 (HB)
ISBN-13 978-1-4020-5183-2 (HB)
ISBN-10 1-4020-5184-0 (e-book)
ISBN-13 978-1-4020-5184-0 (e-book)

Published by Springer,
P.O. Box 17, 3300 AA Dordrecht, The Netherlands.

www.springer.com

Cover photo: Female branch of *Salix tetrasperma* Roxb

Cover photo provided by kind permission of
Dr. Athar Ali Khan
Department of Botany
Aligarh Muslim University
Aligarh 202002
India

Printed on acid-free paper

All Rights Reserved

© 2007 Springer

No part of this work may be reproduced, stored in a retrieval system, or transmitted in any form or by any means, electronic, mechanical, photocopying, microfilming, recording or otherwise, without written permission from the Publisher, with the exception of any material supplied specifically for the purpose of being entered and executed on a computer system, for exclusive use by the purchaser of the work.

**Dedicated To The
Institution and Nation Where We Work**

Contents

Preface	ix
Contributors	xi
1. Salicylic acid: Biosynthesis, metabolism and physiological role in plants S. Hayat, B. Ali and A. Ahmad	1
2. Effects of salicylic acid on the bioproductivity of plants Alfonso Larqué-Saavedra and Rodolfo Martin-Mex	15
3. Effect of salicylic acid on solute transport in plants M. S. Krasavina	25
4. Role of hormonal system in the manifestation of growth promoting and antistress action of salicylic acid F. M. Shakirova	69
5. Role of salicylic acid in the induction of abiotic stress tolerance T. Janda, E. Horváth, G. Szalai and E. Páldi	91
6. The role of salicylates in <i>Rhizobium</i>-legume symbiosis and abiotic stresses in higher plants Fazli Mabood and Donald Smith	151
7. Stress and antistress effects of salicylic acid and acetyl salicylic acid on potato culture technology H.A. Lopez-Delgado, I.M. Scott and M.E. Mora-Herrera	163
8. Salicylic acid and reactive oxygen species in the activation of stress defense genes Loreto Holuigue, Paula Salinas, Francisca Blanco and Virginia Garretón	197
9. The interplay between salicylic acid and reactive oxygen species during cell death in plants J.F. Dat, N. Capelli, F. Van Breusegem	247
10. Salicylic acid as a defense-related plant hormone: Roles of oxidative and calcium signaling paths in salicylic acid biology Tomonori Kawano and Takuya Furuichi	277

11. Salicylic acid and local resistance to pathogens	323
Igor V. Maksimov and Lubov G. Yarullina	
12. Salicylic acid in plant disease resistance	335
Ratnesh Chaturvedi and Jyoti Shah	
13. Transcriptomic analysis of salicylic acid-responsive genes in tobacco BY-2 cells	371
I. Galis and K. Matsuoka	
Index	397

Preface

The organism that we recognise as plant is the result of integrated metabolic functions administered by a number of factors, including hormones. Out of these chemicals, five (Auxins, Gibberellins, Cytokinins, Abscissic acid and Ethylene) are well recognized for their functions but the more recent ones (Brassinosteroids, Salicylic acid, Polyamines and Jasmonates) can not be excluded from the list of hormones because of their involvement in important functions of plants.

This book is providing information related with Salicylic acid (SA) that was first noticed to be a major component in the extract from *Salix* (willow) bark and used as an anti-inflammatory drug. It belongs to phenolic group and is ubiquitous in plants. SA is involved in signal transduction, pondering over the plant resistance to stress and generates significant impact on photosynthesis, transpiration, uptake and transport of ions and growth and development. However, the observations related with this hormone are very much scattered it was, therefore, decided to compile all in the form of a book, based on 13 chapters written by various experts, working in this field. A total of 31 experts have explained their results based on the practical work carried over by them and of others on various selected aspects of plant growth and development. After going through these chapters it may be concluded that the hormone has a wide range of actions by involving genes and / or the membranes.

With great pleasure, we extend our sincere thanks to all the contributors for their timely preparation of excellent and up to dated contributions and also for their consistent support and cooperation.

Thanks are also due to Springer, The Netherlands for expeditious acceptance of our proposal and completion of the review process. Subsequent cooperation and understanding of their staff, especially, Malanie van Overbeek, publishing assistant, is also gratefully acknowledged.

We express our sincere thanks to the members of our family for all the support they provided and the neglect, what so ever, they suffered during the preparation of this book.

Finally we are thankful to the Almighty God.

S. Hayat
A. Ahmad

Contributors

Ahmad A.

Department of Botany,
Aligarh Muslim University,
Aligarh-202002, India

Alfonso Larqué-Saavedra

Centro de Investigación Científica de Yucatán,
A. C., Calle 43 No. 130,
Chuburná de Hidalgo, Mérida, Yucatán,
México CP 97200

Ali B.

Department of Botany,
Aligarh Muslim University,
Aligarh-202002, India

Capelli N.

Laboratoire de Biologie Environnementale (EA 3154 MRT, UC
INRA), Université de Franche- Comté,
UFR Sciences et Techniques,
Place Leclerc, F-25030 Besancon Cedex,
France

Dat J.F.

Laboratoire de Biologie Environnementale (EA 3154 MRT, UC
INRA), Université de Franche- Comté,
UFR Sciences et Techniques,
Place Leclerc, F-25030 Besancon Cedex,
France

Donald Smith

Plant Science Department,
Macdonald Campus of McGill University,
21,111 Lakeshore Road,
Sainte Anne de Bellevue, Qc,
Canada, H9X 3V9

Fazli Mabood

Plant Science Department,
Macdonald Campus of McGill University,
21,111 Lakeshore Road,
Sainte Anne de Bellevue, Qc,
Canada, H9X 3V9

Francisca Blanco
Facultad de Ciencias Biológicas,
Universidad Católica de Chile,
P.O.Box 114-D, Santiago,
Chile

Galis I.
RIKEN Plant Science Center,
1-7-22 Suehiro-cho,
Tsurumi-ku, Yokohama
Japan

Hayat S.
Department of Botany,
Aligarh Muslim University,
Aligarh-202002, India

Horváth E.
Agricultural Research Institute of the Hungarian Academy of
Sciences,
H-2462, Martonvásár, POB. 19.
Hungary

Igor V. Maksimov
Institute of Biochemistry and Genetics,
Ufa Research Centre,
Russian Academy of Science,
450054, Ufa, pr. Oktyabrya, 69,
Russia

Janda T.
Agricultural Research Institute of the Hungarian Academy of
Sciences,
H-2462, Martonvásár, POB. 19.
Hungary

Jyoti Shah
Division of Biology,
Kansas State University,
Manhattan, Kansas 66506
USA

Krasavina M.S.

Timiryazev Institute of Plant Physiology,
Russian Academy of Science,
Botanicheskaya ul. 35, Moscow,
Russia

Lopez-Delgado H.A.

Programa Nacional de Papa,
Instituto Nacional de Investigaciones Forestales Agrícolas y Pecuarias
(INIFAP), Metepec, Méx. 52141, A. P. 1-4.
México

Loreto Holuigue

Facultad de Ciencias Biológicas,
Universidad Católica de Chile,
P.O.Box 114-D, Santiago,
Chile

Lubov G. Yarullina

Institute of Biochemistry and Genetics,
Ufa Research Centre,
Russian Academy of Science,
450054, Ufa, pr. Oktyabrya, 69,
Russia

Matsuoka K.

RIKEN Plant Science Center,
1-7-22 Suehiro-cho,
Tsurumi-ku, Yokohama
Japan

Mora-Herrera M.E.

Programa Nacional de Papa,
Instituto Nacional de Investigaciones Forestales Agrícolas y Pecuarias
(INIFAP), Metepec, Méx. 52141, A. P. 1-4.
México

Páldi E.

Agricultural Research Institute of the Hungarian Academy of
Sciences,
H-2462, Martonvásár, POB. 19.
Hungary

Paula Salinas

Facultad de Ciencias Biológicas,

Universidad Católica de Chile,
P.O.Box 114-D, Santiago,
Chile

Ratnesh Chaturvedi
Division of Biology,
Kansas State University,
Manhattan, Kansas 66506
USA

Rodolfo Martin-Mex
Centro de Investigación Científica de Yucatán,
A.C., Calle 43 No. 130,
Chuburná de Hidalgo, Mérida, Yucatán,
México CP 97200

Scott I.M.
Institute of Biological Sciences,
University of Wales,
Aberystwyth, Ceredigion, SY23 3DA,
UK.

Shakirova F.M.
Institute of Biochemistry and Genetics,
Ufa Scientific Centre,
Russian Academy of Sciences,
69 pr. Octyabrya, 450054, Ufa,
Russia

Szalai G.
Agricultural Research Institute of the Hungarian Academy of
Sciences,
H-2462, Martonvásár, POB. 19.
Hungary

Takuya Furuichi
Graduate School of Medicine,
Nagoya University,
Showa-ku, Nagoya 466-8550,
Japan

Tomonori Kawano
Graduate School of Environmental Engineering,
The University of Kitakyushu,
Kitakyushu 808-0135,
Japan

Van Breusegem F.
Department of Plant Systems Biology,
Ghent University, VIB,
Technologie Park 927, B-9052 Gent,
Belgium

Virginia Garretón
Facultad de Ciencias Naturales,
Universidad Santo Tomás,
Ejército 41, Santiago.
Chile

Chapter 1

SALICYLIC ACID: BIOSYNTHESIS, METABOLISM AND PHYSIOLOGICAL ROLE IN PLANTS

S. HAYAT, B. ALI AND A. AHMAD

Department of Botany, Aligarh Muslim University, Aligarh, INDIA

Abstract: Salicylic acid (SA) is a phenolic derivative, distributed in a wide range of plant species. It is a natural product of phenylpropanoid metabolism. Decarboxylation of transcinnamic acid to benzoic acid and its subsequent 2-hydroxylation results to SA. It undergoes metabolism by conjugating with glucose to SA glucoside and an ester. SA has direct involvement in plant growth, thermogenesis, flower induction and uptake of ions. It affects ethylene biosynthesis, stomatal movement and also reverses the effects of ABA on leaf abscission. Enhancement of the level of chlorophyll and carotenoid pigments, photosynthetic rate and modifying the activity of some of the important enzymes are other roles assigned to SA. This chapter gives a comprehensive coverage to all the above aspects.

Key words: Biosynthesis, chlorophyll, metabolism, photosynthetic rate, salicylic acid

1. INTRODUCTION

Salicylic acid, at one stage of time, was the world's best selling drug synthesized in 1898 in Germany (Raskin, 1992b). However, it was John Buchner (1928) who isolated salicyl alcohol glucoside (Salicine) from willow bark at Munich that was later on named by Rafacle Piria (1938) as salicylic acid (SA). The word salicylic acid (SA) was derived from Latin word "Salix", meaning willow tree. It is ubiquitously distributed in the whole plant kingdom (Raskin *et al.*, 1990) and is classified under the group of plant hormones (Raskin, 1992a). SA is assigned diverse regulatory roles in the metabolism of plants (Popova *et al.*, 1997).

Chemically, SA belongs to an extremely diverse group of plant phenolics, that possess an aromatic ring with a hydroxyl group or its functional derivatives (Figure 1). Free salicylic acid is a crystalline powder that melts at 157-159°C. It is moderately soluble in water but highly soluble in polar organic solvents. The pH of its aqueous solution is 2.4; pKa is 2.98 and log K_{ow} is equal to 2.26 (Raskin, 1992b). Aspirine, an analogue of SA, undergoes spontaneous hydrolysis to SA, in aqueous solution (Mitchell *et al.*, 1967).

Using most modern analytical techniques, SA has been characterized in 36 plants, belonging to diverse groups (Raskin *et al.*, 1990). In plants, such as rice, crabgrass, barley and soybean the level of salicylic acid is approximately 1 mg g⁻¹ fresh mass. Floral parts of seven species and the leaves of twenty seven thermogenic species exhibited substantial variation in the level of SA (Raskin, 1990). Nonetheless, a maximum quantity of 37.19 mg g⁻¹ fresh mass was detected in the leaves of rice. However, SA could not be detected in the thermogenic flowers of water lily, *Victoria regia* Lindl. (Nymphaeaceae) and Palmae, *Bactris major* Jacq. (Raskin, *et al.*, 1990).

Presently there is no clear cut direct evidence that may be used to prove the transportability of SA. However, the physical properties of SA suggest that it could be transported, metabolized and/or conjugated in the plants. Moreover, the exogenously applied SA seems to be carried away from the sites of its initial application to different other tissues of the plants to generate response (Raskin, 1992b).

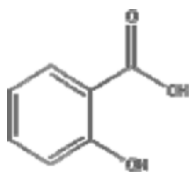

Figure 1. Structure of salicylic acid

2. BIOSYNTHESIS OF SALICYLIC ACID

It is largely believed that SA (ortho-hydrobenzoic acid) is a natural derivative of cinnamic acid, an intermediate in shikmic acid pathway, operative for the synthesis of phenolic compounds. However, two possible routes have been proposed in this direction (Figure 2).

(i) Decarboxylation of the side chain of cinnamic acid to generate benzoic acid, that undergoes hydroxylation, at C-2 position. Recently, this scheme, for the synthesis of SA has been reported in tobacco plants (Yalpani *et al.*, 1993) and also in rice seedlings (Silverman *et al.*, 1995). The enzyme that catalyzes β -oxidation of cinnamic acid to benzoic acid has been identified in *Quercus pedunculata* (Alibert and Ranjeva, 1971; Alibert *et al.*, 1972). However, the other enzyme that is responsible for the conversion of benzoic acid to salicylic acid has not been characterized, so far.

(ii) Hydroxylation of cinnamic acid to o-coumaric acid followed by its decarboxylation to salicylic acid. The conversion of cinnamic acid to o-coumaric acid is believed to be catalyzed by trans-cinnamate-4-hydroxylase (Alibert and Ranjeva, 1971; Alibert *et al.*, 1972) that was first detected in pea seedlings (Russel and Conn, 1967). Later on it was also identified in *Quercus pedunculata* (Alibert and Ranjeva, 1971; Alibert *et al.*, 1972), tubers of *Jerusalem artichoke* (Garbiac *et al.*, 1991) and *Melilotus alba* (Gestetner and Conn, 1974). However, the enzyme that activates the conversion of o-coumaric acid to SA has not yet been identified.

Moreover, incorporation of radioactive ^{14}C -benzoic acid or ^{14}C -cinnamic acid resulted in the formation of labeled SA in *Gaultheria procumbens* (Ellis and Amrchein, 1971). This observation strongly favours the belief that SA is synthesized from cinnamic acid, mediated by benzoic acid as an intermediate but El-Basyuni *et al.* (1964) believe that both the above systems are operative, in higher plants, in the synthesis of SA.

3. METABOLISM OF SALICYLIC ACID

Salicylic acid is known to form conjugates with a number of molecules (Ibrahim and Tower, 1959; Griffiths, 1959; Lee *et al.*, 1995) by glycosylation and less frequently by estrification (Popova *et al.*, 1997). The glucose esters of SA have been reported in suspension cultures of soybean, mung bean (Apte and Laloraya, 1982) and that of sunflower hypocotyls (Klamt, 1962) and also in other higher plants (Griffith, 1959; Ibrahim and Tower, 1959). Similarly, the conjugate (glucoside), β -glucoside-SA, has been identified in suspension culture of *Mallotus japonicus* (Tanaka *et al.*, 1990) and in the roots of *Avena sativa* seedlings (Balke and Schulz, 1987; Yalpani *et al.*, 1992a). Nonetheless, they also identified an enzyme, SA-glycosyltransferase (Gtase), that catalyzes the metabolism of SA to β -glucoside-SA. The presence of a conjugate with amino acids (salicyl aspartic acid) is also reported in wild grapes (Silverman *et al.*, 1995) and French bean (Bourne *et al.*, 1991).

Although, SA-2-O- β -D-glucoside is a predominant conjugate in plants, but other metabolites could be formed by estrification or additional hydroxylation of the aromatic ring. Out of them, 2,3-dihydroxybenzoic acid (O-pyrocatechuic acid) and 2,5-dihydrobenzoic acid (Gentic acid) were identified in the leaves of *Astilbe sinensis* and *Lycopersicon esculentum*, fed with ^{14}C -cinnamic acid and ^{14}C -benzoic acid (Billek and Schmoock, 1967; Chadha and Brown, 1974).

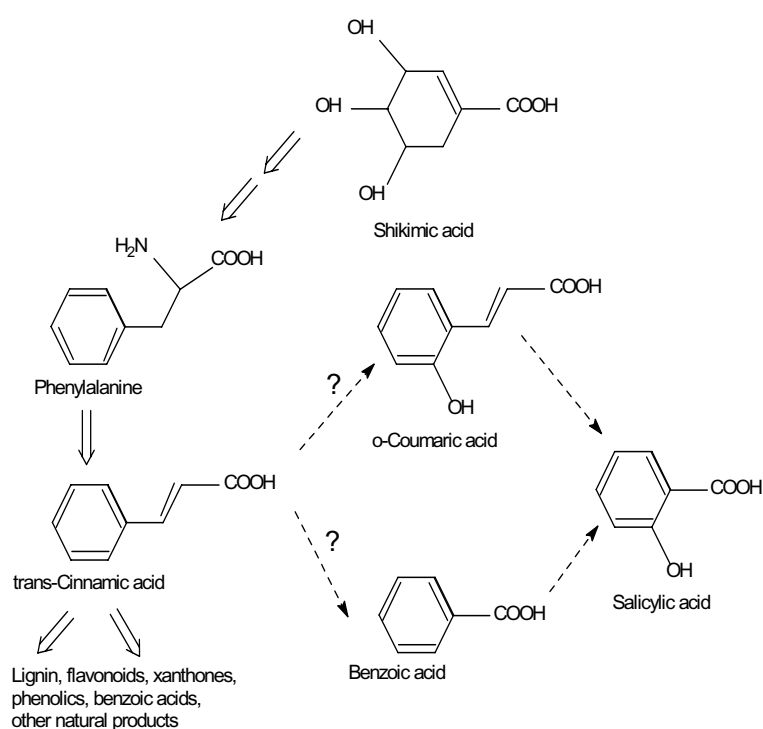

Figure 2. Proposed pathway for salicylic acid biosynthesis in plants.

4. PHYSIOLOGICAL ROLE OF SALICYLIC ACID

4.1 Effect of SA on plant growth

It is well documented that phenolic compounds exert their influence on physiological and biochemical processes including, photosynthesis, ion

uptake, membrane permeability, enzyme activities, flowering, heat production and growth and development of plants. One, such a natural compound is salicylic acid that may function as plant growth regulator (Arberg, 1981). The application of salicylic acid (SA), acetylsalicylic acid (ASA) gentisic acid (GTA) or other analogues of SA, to the leaves of corn and soybean accelerated their leaf area and dry mass production but plant height and root length remained unaffected (Khan *et al.*, 2003). Out of the various concentrations of SA used, Fariduddin *et al.* (2003) observed maximum increase in dry matter accumulation at a concentration of 10^{-5} M, supplemented to the leaves of the standing plants of *Brassica juncea* but the concentrations, above that proved inhibitory (Figure 3). Moreover, wheat seedlings, raised from the grains soaked in 10^{-5} M of SA possessed more number of leaves and higher fresh and dry mass (Figure 4), compared with water soaked, control (Hayat *et al.*, 2005). Likewise, Pancheva *et al.* (1996) treated 2-day old seedlings of barley with SA whose growth was significantly enhanced but leaf emergence was delayed. The blades expanded slowly, over a longer span of time and the mature blades were narrow and shorter. The stem cuttings of some ornamental plants, treated with SA, exhibited a rapid rate of root differentiation (Singh *et al.*, 1993). In contrary to the above, Pancheva *et al.* (1996) observed an inhibition in the growth of leaves and roots of barley seedlings, treated with salicylic acid and an increase in the concentration of SA enhanced it further. Similarly, a dose dependent, inhibition in bud formation in *Funaria hygromatica* was reported by Christianson and Duffy (2002).

4.2 Effect of SA on attributes, related to photosynthesis

The metabolic aspects of plants, supplied with SA or its derivatives, shifted to a varied degree, depending on the plant type and the mode of application of SA. The application of SA (20 mg ml^{-1}) to the foliage of the plants of *Brassica napus* improved the chlorophyll contents (Ghai *et al.*, 2002). Similarly, soaking the grains of wheat in 10^{-5} M of SA resulted in the plants with higher pigment contents which declined as the concentration of SA was increased above that (Hayat *et al.*, 2005). Moreover, 30 day old plants of *Brassica juncea* sprayed with 10^{-5} M of SA possessed chlorophyll 20% higher than those sprayed by water only, however the maximum concentration (10^{-3} M) decreased the chlorophyll contents and the values were below that of water sprayed control, at 60 day stage (Fariduddin *et al.*, 2003; Figure 3). However, the leaves of corn and soybean applied with acetyl salicylic acid (ASA) or gentisic acid (GTA), exhibited no change in their chlorophyll contents (Khan *et al.*, 2003). Nonetheless, soaking the seeds of *Vigna mungo* in aqueous solutions of SA (10-150 μm) lead a

decrease in the contents of chlorophyll and carotenoid in the leaves of subsequent plants, but supplementing SA through irrigant did not prove as severe as seed-treatment (Anandhi and Ramanujam, 1997). Similarly, the leaves of barley plants had less chlorophyll, if added with 100 μM to 1 mM of SA to the culture medium (Pancheva *et al.*, 1996). Salicylic acid activated the synthesis of carotenoids, xanthophylls and the rate of de-epoxidation but decreased the level of chlorophyll pigments, both in wheat and moong plants and also the ratio of chlorophyll a/b, in wheat seedlings (Moharekar *et al.*, 2003). Furthermore, *Spirodela* fed with salicylic acid, possessed less anthocianin and chlorophyll pigments (Khurana and Maheshwari, 1980).

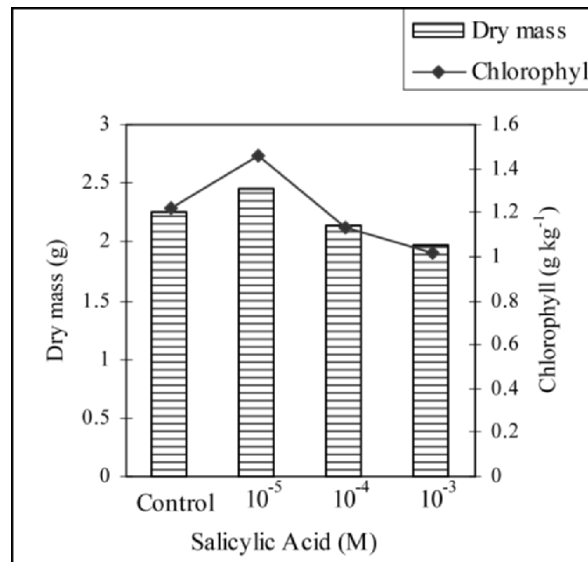

Figure 3. Effect of leaf applied SA on dry mass and chlorophyll content of 60 day old *Brassica juncea* plants

Leaf-applied SA induced stomatal closure in *Phaseolus vulgaris* (Larqué-Saavedra, 1979) and decreased transpiration rate in *Phaseolus vulgaris* and *Commelina communis* (Larqué-Saavedra, 1978, 1979). However, Khan *et al.* (2003) observed an increase in transpiration rate and stomatal conductance in response to the spray of SA, ASA and gentisic acid (GTA) on the foliage of corn and soybean. Moreover, the leaves of soybean exhibited increased water use efficiency, higher rate of transpiration and increased internal CO₂ concentration, on being supplemented with SA (Kumar *et al.* 2000). Similarly, barley plants, exposed to SA for a week, expressed an increase in the CO₂ compensation point and stomatal resistance (Pancheva *et al.*, 1996).

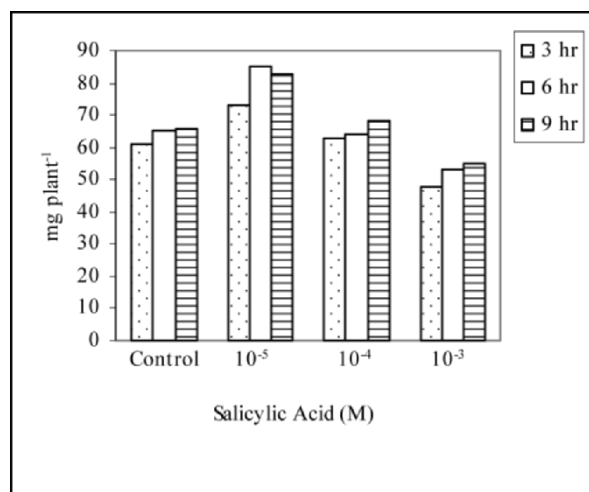

Figure 4. Effect of presowing seed treatment with salicylic acid for different durations on dry mass in wheat at 30 days after sowing

The response of the intact plants and/or their parts to SA-treatment involves a shift in the activity of the enzyme/s, of the process. The activity of carbonic anhydrase in the leaves of mustard, supplied with 10^{-5} M of SA to the foliage (Fariduddin *et al.*, 2003) or as pre-sowing seed treatment to wheat grains (Hayat *et al.*, 2005; Figure 5) was significantly enhanced. In both these studies, the authors observed a decline in the activity of carbonic anhydrase at the two subsequent higher concentrations (10^{-4} and 10^{-3} M) and 10^{-3} M proved to be supraoptimal. The activity of the other very important enzyme, ribulose-1,5-biphosphate carboxylase/oxygenase (RuBPCO) in barley plants, exposed to SA treatment for a week, decreased by about 50% and this loss was in proportion to the concentration (100 μ M to 1 mM) of SA (Pancheva and Popova, 1997). Moreover, they also noted an increase in PEPCase in barley and a decline in the photosynthetic rate. Contrary to the above observations, the activity of rubisco in stressed-maize plants (Khodary, 2004) and photosynthetic rate in mustard plants (Fariduddin *et al.*, 2003; Figure 3) increased under the influence of SA. Moreover, Fariduddin *et al.* (2003) also observed increased water use and carboxylation efficiencies in association with high photosynthetic rate in mustard plants, although the higher concentrations (10^{-4} and 10^{-3} M) of SA proved deleterious. Likewise, SA stimulated photosynthetic rate in soybean, barley and/or maize (Khodary, 2004, Pancheva *et al.*, 1996, Kumar *et al.*, 2000, Khan *et al.*, 2003).

4.3 Effect of SA on nitrate metabolism

A concentration (0.01-1.0 mM) of $\text{Ca}(\text{NO}_3)_2$ in association with SA activated the uptake of nitrogen and the activity of nitrate reductase (NR) both in the leaves and roots of maize plants, although higher concentration (5 mM) proved inhibitory (Jain and Srivastava, 1981). Similarly, SA increased the activity of NR in the presence of NO_3 and also favoured protection of the enzyme against protease, trypsin (Rane *et al.*, 1995). The plants resulting from the wheat grains, soaked in aqueous solution (10^{-5}M) of SA, exhibited high NR activity (Hayat *et al.*, 2005) and also in mustard leaves whose foliage was fed with SA (10^{-5}M) (Fariduddin *et al.*, 2003; Figure 7). In the former, 10^{-5}M of SA enhanced the activity of the enzyme by 36 % and by 13 % in the latter, as compared to their respective controls. Moreover, in both these cases the maximum concentration (10^{-3}M) of SA proves to be inhibitory, that decreased the activity of NR by 14 % in wheat seedlings and 10 % in mustard plants. Higher NR activity, under the influence of SA, in *Glycine max* was coupled with protein content (Kumar *et al.*, 1999) but SA decreased the level of soluble proteins in barley (Pancheva *et al.*, 1996). Nonetheless the level of sugars, starch and phenols exhibited a decrease in *Vigna mungo* cultivars in response to SA (10-50 μM) treatment (Anandhi and Ranjeva, 1997).

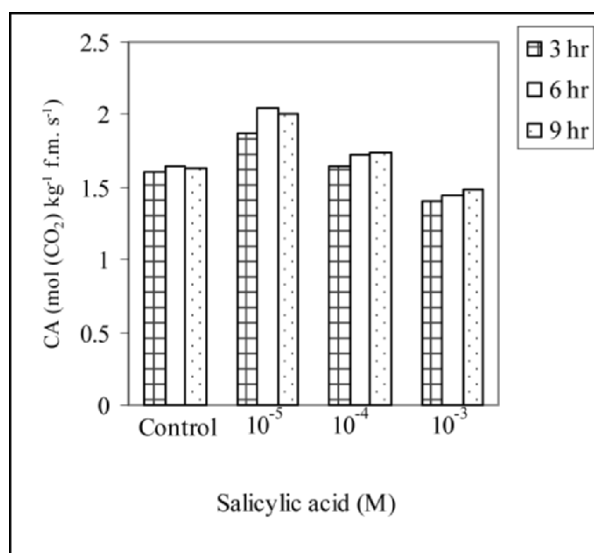

Figure 5. Effect of presowing seed treatment with salicylic acid for different durations on CA activity in wheat at 30 days after sowing

4.4 Effect of SA on ethylene production

Comparing the effect, generated by 22 related phenolic compounds, it was demonstrated that out of them SA and ASA inhibit ethylene production where the effect of SA was inversely dependent on the pH of culture medium and did not require continuous supply of salicylate. Moreover, the inhibitory actions of SA most closely resembled with that of dinitrophenol, a known inhibitor of ethylene forming enzyme (Leslie and Romani, 1980). In a similar study Romani *et al.* (1989) observed that SA and ASA inhibited ethylene production by about 90%, in apple discs, within three hours.

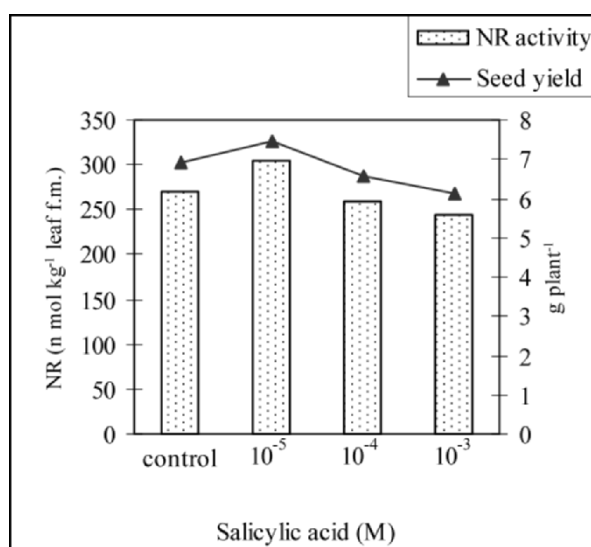

Figure 6. Effect of leaf applied SA on NR activity at 60 day stage and seed yield of *Brassica juncea* plants at harvest

4.5 Effect of SA on mineral nutrients

The plants also exhibit a shift in their nutrient status, under the impact of salicylic acid. The uptake of phosphate (Glass, 1973) and subsequently that of potassium (Glass, 1974) by barley roots was reduced by SA. However, the inhibition of the absorption of potassium by oat roots, under the impact of SA, was dependent on the pH and the concentration of the element in the medium. This inhibition was more prominent at lower pH, suggesting higher activity of protonated form of salicylic acid (Harper and Balke, 1981; Gordon *et al.* 2002). SA also caused the collapse of the transmembrane

electrochemical potential of mitochondria and the ATP dependent proton gradient of tonoplast enriched vesicles (Macri *et al.*, 1986).

4.6 Effect of SA on heat production

The involvement of SA in heat production in plants is well documented (Raskin, 1992b). The contents of SA, in five aroid species and in male cones of four thermogenic cycads, during heat production, increased by about 1 mg g⁻¹ (Raskin *et al.*, 1990). Besides this significant observation, the use of modern analytical techniques (Raskin *et al.*, 1989) proved, SA to be a clerigen (heat producer) and an integral endogenous regulator of heat production, in plants (Popova *et al.*, 1996). Therefore, the exogenous application of SA @ 0.13 mg g⁻¹ fresh mass to the sections of immature appendix of lilies led to an increase in temperature by 12°C (Raskin *et al.*, 1989). The mechanism of action of SA in thermogenic species, tobacco leaves is suggested to be through its action on respiration whose increased rate elevates the surface temperature (Van-Straten *et al.*, 1995).

4.7 Effect of SA on flowering

The very first physiological response, ever attributed to SA in plants, was its impact on flower induction in tobacco tissue culture, supplemented with kinetin and indole acetic acid (Lee and Skoog, 1965; Eberhard *et al.*, 1989). This impact of SA was later demonstrated in a number of plant species, belonging to different families. SA accelerated flower initiation in *Lemma*, although the effect on the rate of subsequent flower development was not so significant (Cleland and Ajami, 1974; Cleland and Tanaka, 1979). Similarly, SA stimulated flowering in *Xanthium strumarium* (Cleland and Ajami, 1974). Moreover, aspirine, an analogue of SA, hastened flowering under non-inductive photoperiod, in *Spirodela polyrrhiza* (Khurana and Maheshwari, 1980), *Spirodela punctata* (Scharfetter *et al.*, 1978) and *Wolffia microscopica* (Khurana and Maheshwari, 1987; Tamot *et al.*, 1987) and in combination with sucrose it enhanced flower opening in *Oncidium* (Hew, 1987). Similarly, flowering in *Pisita stratiotes*, a member of family Araceae, was also accelerated by incorporating the culture medium with SA (Piterse, 1982). The application of SA to the foliage of soybean also hastened flower bud and pod formation by 2-5 days (Kumar *et al.*, 1999). This compelled the scientists to conclude that salicylic acid somehow acts as an endogenous regulator of flowering (Cleland and Ajami, 1974).

Comparing the individual effect of GA, β-naphthol and that of SA on flowering in *Impatiens balsamina*, Nanda *et al.* (1976) and Sood and Nanda (1979) reported that SA generated an effect synergistic to that of GA.

Similar synergyism on flowering has also been reported in *Arabidopsis thaliana* (Goto, 1981). In another study Kumar *et al.* (2000) compared the flower inducing effect of SA with that of GA, kinetin, NAA, ethrel and chloro choline chloride (CCC). They found that SA and/or GA were most effective than any other combination of the hormones. The specific flower inducing mechanism that involves salicylic acid is yet to be explored. However, Ooto (1975) hypothesized the belief that free o-hydroxyl group on Benzoic acid confers metal chelating characteristic that favours flower induction. This view gets the support from the observations where chelating agents induce flowering in Lamnaceae (Seth *et al.*, 1970; Ooto, 1972) and were comparable with that of the SA (Piters, 1977). Raskin (1992) on the basis of flower inducing (florigenic) activity of benzoic acid (Watanab and Takimoto, 1979; Fujioka *et al.*, 1983) and other non-chelating phenolic compounds (Watanab *et al.*, 1981), concluded that additional flower inducing mechanisms, other than the general belief, may be involved, that made the question wide open for further work.

5. REFERENCES

- Alibert, G., and Ranjeva, R., 1971. Recherches sur les enzymes catalysant la biosynthese des acides phenoliques chez *Quercus pedunculata* (Ehrn): I – Formation des series cinnamique et benzoique. *FEBS Lett.*, **19**: 11-14.
- Alibert, G., and Ranjeva, R., 1972. Recherches sur les enzymes catalysant la biosyntheses des acid phenoliques chez *Quercus pedunculata* (Ehrn): II- Localization intercellulaire de la phenylalanin mmonique-lyase, de la cinnamate 4-hydroxylase, et de la “benzoate synthase” *Biochem. Biophys. Acta*, **279**: 282-289.
- Anandhi, S., and Ramanujam, M. P., 1997. Effect of salicylic acid on black gram (*Vigna mungo*) cultivars. *Ind. J. Plant Physiol.* **2**: 138-141.
- Apte, P. V., and Laloraya, M. M., 1982. Inhibitory action of phenolic compounds on abscisic acid induced abscission. *J. Exp. Bot.*, **33**: 826-830.
- Arberg, B., 1981. Plant growth regulators. Monosubstituted benzoic acid. *Swed. Agric. Res.*, **11**: 93-105.
- Balke, N. E., and Schulz, M., 1987. Potential impact of enzymatic glucosidation of allelopathic phenolic compounds. In : Invited Lectures, Sec. 4: Industrial chemistry, 31st Int. Cong. Pure Appl. Chem. Pp. 17-29, Sophia, Bulgaria : Bulg. Acad. Sci.
- Billek, G., and Schmook, F. P., 1967. Zur biosynthese der gentisinaure. *Monatsch Chem.*, **98**: 1651-1664.
- Chadha, K. C., and Brown, S. A., 1974. Biosynthesis of phenolic acids in tomato plants infected with *Agrobacterium tumefaciens*. *Can. J. Bot.*, **52**: 2041-2046.
- Christianson, M. L., and Duffy, S. H., 2002. Dose-dependent effect of salicylates in a moss, *Funaria hygrometrica*. *J. Plant Growth Regul.*, **21**: 200-208.
- Cleland, C. F., and Ajami, A., 1974. Identification of a flower-inducing factor, isolated aphid honeydew as being salicylic acid. *Plant Physiol.*, **54**: 904-906.
- Cleland, C. F., and Tanaka, O., 1979. Effect of day length on the ability of salicylic acid to induce flowering in the long-day *Lema gibba* G₃ and the short-day plant *Lemma paucicostata* 6746. *Plant Physiol.*, **64**: 421-424.

- Eberhard, S., Doubrava, N., Marta, V., Mohnen, D., Southwick, A. *et al.* 1989, Pectic cell wall fragments regulate tobacco thin cell layer explant morphogenesis. *Plant Cell*, **1**: 747-755.
- El-Basyouni, S., Chen, D., Ibrahim, R., Neish, A.C., and Towers, G. H. N., 1964. The biosynthesis of hydroxybenzoic acids in higher plants. *Phytochem.* **3**: 485-492.
- Ellis, B. E., and Amichein, N., 1971. The "NH-shift" during aromatic orthohydroxylation in higher plants. *Phytochem.*, **10**: 3069-3072.
- Fariduddin, Q., Hayat, S., and Ahmad, A., 2003. Salicylic acid influences net photosynthetic rate, carboxylation efficiency, nitrate reductase activity and seed yield in *Brassica juncea*. *Photosynthetica*, **41**: 281-284.
- Fujioka, S., Yamaguchi, I., Murofushi, N., Takahashi, N., Kaihara, S., and Takimoto, A., 1983. The role of plant hormones and benzoic acid in flowering of *Lamium paucicostata* 151 and 381. *Plant Cell Physiol.*, **24**: 241-246.
- Gabriace, B., Werck-Reichhart, D., Teutsch, H., and Durst, F., 1991. Purification and immunocharacterization of a plant cytochrome P450: the cinnamic acid 4-hydroxylase. *Arch. Biochem. Biophys.*, **288**: 302-309.
- Gestetner, B., and Conn, E. E., 1974. The 2-hydroxylation of transcimannic acid by chloroplasts from *Melilotus alba* Desr. *Arch. Biochem. Biophys.* **163**: 617-624.
- Ghai, N., Setia, R.C., and Setia, N., 2002. Effects of paclobutrazol and salicylic acid on chlorophyll content, hill activity and yield components in *Brassica napus* L. (cv. GSL-1). *Phytomorphol.*, **52**: 83-87.
- Glass, A. D., 1973. Influence of phenolic acids on ion uptake. I. Inhibition of phosphate uptake. *Plant Physiol.*, **51**: 1037-1041.
- Glass, A. D., 1974. Influence of phenolic acids upon ion uptake. III. Inhibition of potassium absorption. *J. Exp. Bot.*, **25**: 1104-1113.
- Gordon, L. K., Minibayeva, F. V., Ogerodnikova, T. I., Rakhmatullina, D. F., Tzentzevitzky, A. N., Maksyntin, D. A., and Valitova, J. N., 2002. Salicylic acid induced dissipation of the proton gradient on the plant cell membrane. *Doklady Biol. Sci.*, **387**: 581-583.
- Goto, N., 1981. Enhancement of gibberellic acid by 5-bromodeoxyuridine, salicylic acid and benzoic acid on the flowering of *Arabidopsis thaliana*. *Arabidopsis Inf. Serv.*, **18**: 157-160.
- Griffiths, L. A., 1959. On the distribution of gentisic acid in green plant. *J. Exp. Bot.*, **10**: 437-442.
- Harper, J. P., and Balke, N. E., 1981. Characterization of the inhibition of K⁺ absorption in oat roots by salicylic acid. *Plant Physiol.*, **68**: 1349-1353.
- Hayat, S., Fariduddin, Q., Ali, B., and Ahmad, A., 2005. Effect of salicylic acid on growth and enzyme activities of wheat seedlings. *Acta Agron. Hung.*, **53**: 433-437.
- Ibrahim, R. K., and Towers, G. H. N., 1959. Conversion of salicylic acid to gentisic acid and o-pyrocatechuic acid, all labeled with carbon-14, in plants. *Nature*, **184**: 1803.
- Jain, A., and Srivastava, H. S., 1981. Effect of salicylic acid on nitrate reductase activity in maize seedlings. *Physiol. Plant.*, **51**: 339-342.
- Khan, W., Prithviraj, B., and Smith, D. L., 2003. Photosynthetic responses of corn and soybean to foliar application of salicylates. *J. Plant Physiol.* **160**: 485-492.
- Khodary, S. F. A., 2004. Effect of salicylic acid on the growth, photosynthesis and carbohydrate metabolism in salt stressed maize plants. *Int. J. Agric. Biol.*, **6**: 5-8.
- Khurana, J. P., and Maheshwari, S. C., 1980. Some effects of salicylic acid on growth and flowering in *Spirodela polyrrhiza* SP20. *Plant Cell Physiol.*, **21**: 923-927.
- Khurana, J. P., and Maheshwari, S. C., 1987. Floral induction in *Wolffia microscopica* by non-inductive long days. *Plant Cell Physiol.*, **24**: 907-912.

- Klambt, H. D., 1962. Conversion in plants of benzoic acid to salicylic acid and its β -glucoside. *Nature*, **196**: 491.
- Kumar, P., Dube, S. D., and Chauhan, V.S., 1999. Effect of salicylic acid on growth, development and some biochemical aspects of soybean (*Glycine max* L. Merrill). *Ind. J. Plant Physiol.*, **4**: 327-330.
- Kumar, P., Lakshmi, N.J., and Mani, V. P., 2000. Interactive effects of salicylic acid and phytohormones on photosynthesis and grain yield of soybean (*Glycine max* L. Merrill). *Physiol. Mol. Biol. Plants*. **6**: 179-186.
- Larqué-Saavedra, A., 1978. The anti-transpirant effect of acetylsalicylic acid on *Phaseolus vulgaris* L., *Physiol. Plant.*, **43**: 126-128.
- Larqué-Saavedra, A., 1979. Stomatal closure in response to acetylsalicylic acid treatment. *Z. Pflanzenphysiol.*, **93** (4): 371-375.
- Lee, T. T., and Skoog, F., 1965. Effect of substituted phenols on bud formation and growth of tobacco tissue culture. *Physiol. Plant.*, **18**: 386-402.
- Leslie, C. A., and Romani, R. J., 1988. Inhibition of ethylene biosynthesis by salicylic acid. *Plant Physiol.*, **88**: 833-837
- Macri, F., Kanello, A., and Pennazio, S., 1986. Salicylate-collapsed membrane potential in pea stem mitochondria. *Physiol. Plant.*, **67**: 136-140.
- Mitchell, A. G., and Broadhead, J. F., 1967. Hydrolysis of solubilized aspirine. *J. Pharm. Sci.*, **56**: 1261-1266.
- Moharekar, S. T., Lokhande, S. D., Hara, T., Tanaka, R., Tanaka, A., and Chavan, P.D., 2003. Effect of salicylic acid on chlorophyll and carotenoid contents of wheat and moong seedlings. *Photosynthetica*, **41**: 315-317.
- Nanda, K. K., Kumar, S., and Sood, V., 1976. Effect of gibberellic acid and some phenols on flowering of *Impatiens balsamina*, a qualitative short-day plant. *Physiol. Plant.*, **38**: 53-56.
- Oota, Y., 1972. The response of *Lemma gibba* G3 to a single long day in the presence of EDTA. *Plant Cell Physiol.*, **13**: 575-580.
- Oota, Y., 1975. Short-day flowering of *Lamma gibba* G3 induced by salicylic acid. *Plant Cell Physiol.*, **16**: 1131-1135.
- Pancheva, T. V., and Popova, L. P., 1998. Effect of salicylic acid on the synthesis of ribulose-1,5-biphosphate carboxylase/oxygenase in barley leaves. *J. Plant Physiol.*, **152**: 381-386.
- Pancheva, T. V., Popova, L. P., and Uzunova, A. M., 1996. Effect of salicylic acid on growth and photosynthesis in barley plants. *J. Plant Physiol.*, **149**: 57-63.
- Pitersen, A. H., 1982. A review of chemically induced flowering in *Lemma gibba* G3 and *Pistia stratiotes*. *Aquat. Bot.*, **13**: 21-28.
- Pitersen, A.H., and Muller, L. J., 1977. Induction of flowering in *Lemma gibba* G3 under short day conditions. *Plant Cell Physiol.*, **18**: 45-53.
- Popova, L., Pancheva, T., and Uzunova, A., 1997. Salicylic acid : Properties, biosynthesis and physiological role. *Bulg. J. Plant Physiol.*, **23**: 85-93.
- Rane, J., Lakshini, K. C., Kumar, P. A., and Abrol, Y. P., 1995. Salicylic acid protects nitrate reductase activity of wheat leaves. *Plant Physiol. Biochem.*, **22**: 119-121.
- Raskin, I., 1992a. Role of salicylic acid in plants. *Ann. Rev. Plant Physiol. Plant Mol. Biol.*, **43**: 439-463.
- Raskin, I., 1992b. Salicylate, a new plant hormone. *Plant Physiol.*, **99**: 799-803.
- Raskin, I., Skubatz, H., Tang, W., and Meeuse, B. J. D., 1990. Salicylic acid levels in thermogenic and nonthermogenic plants. *Ann. Bot.*, **66**: 376-383.
- Raskin, I., Turner, I. M., and Melander, W. R., 1989. Regulation of heat production in the inflorescences of an *Arum* lily by endogenous salicylic acid. *Proc. Natl. Acad. Sci. USA*, **86**: 2214-2218.

- Romani, R. J., Hess, V. M., and Leslie, C. A., 1989. Salicylic acid inhibition of ethylene production by apple discs and other plant tissues. *J. Plant Growth Regul.*, **8**: 62-69.
- Russell, D. W., and Conn, E. E., 1967. The cinnamic acid 4-hydroxylase of pea seedlings. *Arch. Biochem. Biophys.*, **122**: 256-258.
- Scharfettez, E., Rottenburg, T., and Kandeler, R., 1978. The effect of EDDHA and salicylic acid on flowering and vegetative development in *Spirodela punctata*. *Z. Pflanzenphysiol.* **87**: 445-454.
- Seth, P. N., Venkatarman, R., and Maheshwari, S. C., 1970. Studies on growth and flowering of a short-day plant, *Wolffia microscopica* III. Role of metal ions and chelates. *Planta*, **90**: 349-359.
- Silverman, P., Seskar, M., Kanter, D., Schweizer, P., Mettraux, J. P., and Raskin, I., 1995. Salicylic acid in rice, biosynthesis, conjugation and possible role. *Plant Physiol.*, **108**: 633-639.
- Singh, S. P., 1993. Effect of non-auxinic chemicals on root formation in some ornamental plant cuttings. *Adv. Hortic. For.*, **3**: 207-210.
- Sood, V., and Nanda, K., 1979. Effect of gibberellic acid and monophenols on the flowering of *Impatiens balsamina* in relation to the number of inductive and non-inductive photoperiodic cycles. *Physiol. Plant.*, **45**: 250-254.
- Tomot, B.K., Khurana, J.P., and Maheshwari, S.C., 1987. Obligate requirement of salicylic acid for short day induction of flowering in new duck weed, *Wolffia hyaline* 7378. *Plant Cell Physiol.*, **28**: 349-353.
- Van der Straeten, D., Chaerle, L., Sharkov, G., Lambers, H., and Van Montagere, M., 1995. Salicylic acid enhances the activity of the alternative pathway of respiration in tobacco leaves and induces thermogenesis. *Planta*, **196**: 421-419.
- Watanabe, K., Fujita, T., and Takimoto, A., 1981. Relationship between structure and flower inducing activity of benzoic acid derivatives in *Lemna paucicostata* 151. *Plant Cell Physiol.*, **20**: 847-850.
- Watanabe, K., and Takimoto, A., 1979. Flower inducing effect of benzoic acid and some related compounds in *Lemna paucicostata* 151. *Plant Cell Physiol.*, **22**: 1469-1479.
- Weissmann, G., 1991. Aspirine. *Sci. Am.*, **264**: 84-90.
- Yalpani, N., Leen, J., Lawthon, M. A., and Raskin, I., 1993. Pathway of salicylic acid biosynthesis in healthy and virus-inoculated tobacco. *Plant Physiol.*, **103**: 315-321.
- Yalpani, N., Schulz, M., Davies, M. P., and Balke, N. E., 1992. Partial purification of an inducible uridine-5'-diphosphate glucose : salicylic acid glucosyltransferase from oat roots. *Plant Physiol.*, **100**: 457-463.

Chapter 2

EFFECTS OF SALICYLIC ACID ON THE BIOPRODUCTIVITY OF PLANTS

ALFONSO LARQUÉ-SAAVEDRA AND RODOLFO MARTIN-MEX

Centro de Investigación Científica de Yucatán, A. C., Calle 43 No. 130, Chuburná de Hidalgo, Mérida, Yucatán, México CP 97200.

Abstract: Salicylic acid is a plant growth regulator that increases plant bioproductivity. Experiments carried out with ornamental or horticultural plants in greenhouse conditions or in the open have clearly demonstrated that they respond to this compound. Moreover, lower quantities of SA are needed to establish positive responses in the plants. The effect on ornamental plants is expressed as the increase in plant size, the number of flowers, leaf area and the early appearance of flowers. In horticultural species, the effect reported is the increase of yield without affecting the quality of the fruits. It is proposed that the increase in bioproductivity is mainly due to the positive effect of SA on root length and its density.

Key words: Salicylic acid, bioproductivity, root length, root density, earliness, yield, flowering.

1. INTRODUCTION

In the early seventies it was demonstrated that abscisic acid (ABA) was involved in controlling the water status of plants. Moreover, it was suggested that its presence could be linked to drought tolerance of plants (Larqué-Saavedra and Wain, 1974). Thereafter, in a series of experiments an attempt was made to demonstrate how the ABA production was inherited (Larqué-Saavedra and Wain, 1976). The induction to accumulate ABA by plant cells was then considered as a key question in this line of research, where it was proposed that receptors for drought may be localized in the membrane. A hypothetical model was set, in order to demonstrate this and compounds

such as prostaglandins and aspirin were tested. However, when the bioassays were conducted, it was detected that Aspirin affected the stomatal aperture of beans and *Commelina* plants (Larqué-Saavedra, 1978, 1979a, b). This unexpected effect was followed by a series of other assays that provided the fundamental basis to consider that salicylates affect the physiology of plants. Further studies were also carried out in these laboratories to study the salicylates and their relation to bioproductivity. In the literature, it was evident that the efforts were concentrated on learning the role of salicylic acid in systemic acquired resistance (SAR) to pathogens.

2. BIOPRODUCTIVITY

Bioproductivity of plants has been one of the main topics of agricultural sciences and different experts (geneticists, plant breeders, biotechnologists, plant nutritionists, plant physiologists, etc) have been trying to describe it. One of the main proposals suggests that the root system plays a key role in the productivity of any plant and salicylates were reported to favor the effect of indolacetic acid in rooting of mung beans (Basu *et al.*, 1969) and neem rootstocks (Mohinder *et al.*, 1992). In this respect in 1974, an observation was made in one of the bioassays where Aspirin favored the rooting of bean explants (Larqué-Saavedra *et al.*, 1975). Since then research work has focused on determining if salicylates could play a role in promoting better root systems in plants and if such an effect could give a better performance of the plant. However, it is important to mention that reproducible results were obtained by the applications of lower concentrations of salicylates.

2.1 Effect of salicylates in root system

Increasing the total soil volume explored by the root of the plant is one of the best ways to improve yield since more water and nutrients may be taken up by the plants. A second important aspect is to increase rooting density which occurs as a result of increased initiation of secondary roots. In experiments carried out with salicylic acid both aspects (root length and density) were found to be affected. Such studies did not include the resistance to water flow into the root, however, it is expected that a positive relationship may be observed.

Once it was observed that SA affected rooting, additional assays were conducted in order to determine the effect of SA on root growth and development. In a study carried out in 1996 it was reported that foliar application of SA to the shoots of soybean plants significantly affected the size of the root (Gutierrez-Coronado *et al.*, 1998; Figure 1). Further work

has reproduced similar findings with *Tagetes erecta*, using concentrations as low as 10^{-10} M solutions of SA (Sandoval-Yepiz, 2004; Figure 2).

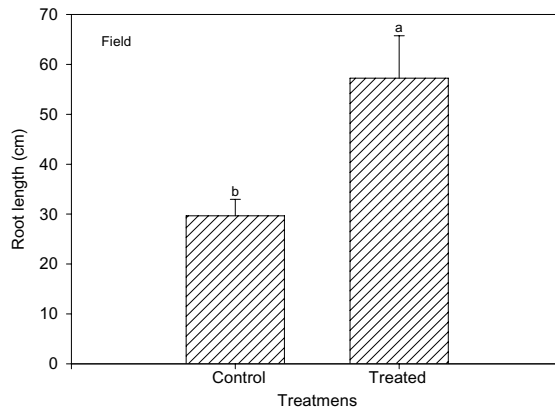

Figure 1. Effect of shoot applied salicylic acid (10^{-8} M) on root length of *Glycine max*, under field conditions, 7 days after the treatment.

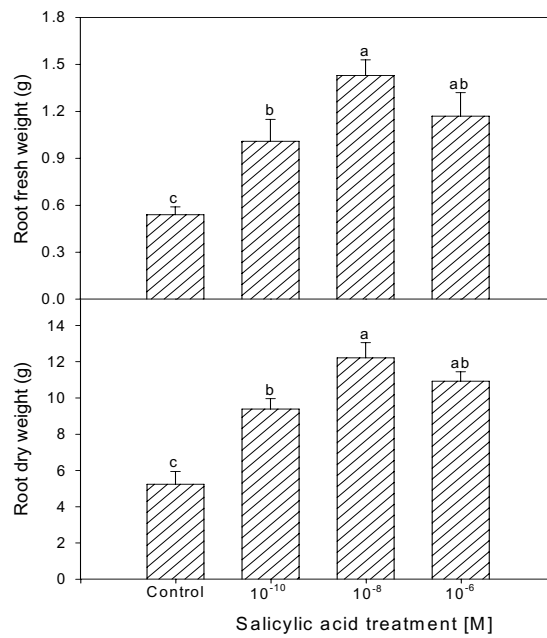

Figure 2. Effect of salicylic acid applications on the fresh and dry mass of *Tagetes erecta*.

2.2 Effect of salicylates on shoot growth

Application of salicylates to plants increased the shoot growth in different plant species such as *Clitoria* where the biomass production is important as forage for animal feed (Martin-Mex and Larqué-Saavedra, 2001). Similarly, when it was applied to ornamental plants the biomass always increased. Data showed that values for stem diameter, number of leaves, shoot fresh and dry mass, were higher, in a response to SA treatment.

In ornamental plants, such as gloxinia and violet, SA increased the number of leaves formed, and leaf area had values over 10% of that of the control. Similar values were recorded for the diameter of the rosette plant (Tables 1 and 2).

Table 1. Effect of salicylic acid on the growth of *Sinningia speciosa* 'Ultra' (gloxinia) Values are the mean of 25 replicate samples per treatment, \pm standard error.

Treatments	Number of leaves	Leaf area (cm ²)
Control	13 \pm 0.6a	456.4 \pm 3.0c
10 ⁻¹⁰ M AS	13 \pm 0.4a	496.2 \pm 2.3bc
10 ⁻⁸ M AS	13 \pm 0.6a	680.9 \pm 1.2a
10 ⁻⁶ M AS	14 \pm 0.4a	565.2 \pm 1.6b

Means with the same letter are not significantly different at $P \geq 0.05$, Tukey's

Table 2. Effect of salicylic acid on the growth of *Saintpaulia ionantha* (violet) Values are the mean of 20 replicate samples per treatment, \pm standard error.

Treatments	Number leaves	Rosette diameter (cm)
Control	16 \pm 1 b	139 \pm 16 b
10 ⁻¹⁰ M AS	19 \pm 2 a	177 \pm 12 a
10 ⁻⁸ M AS	18 \pm 3 ab	152 \pm 11ab
10 ⁻⁶ M AS	18 \pm 2 ab	156 \pm 10 a

Means with the same letter are not significantly different at $P \geq 0.05$, Tukey's

In a series of experiments run with *Tagetes erecta* cultivated in open conditions, it was found that beside the floral characters, the biomass of the shoot was significantly affected by the application of low concentration of SA (Sandoval-Yepiz, 2004; Figure 3).

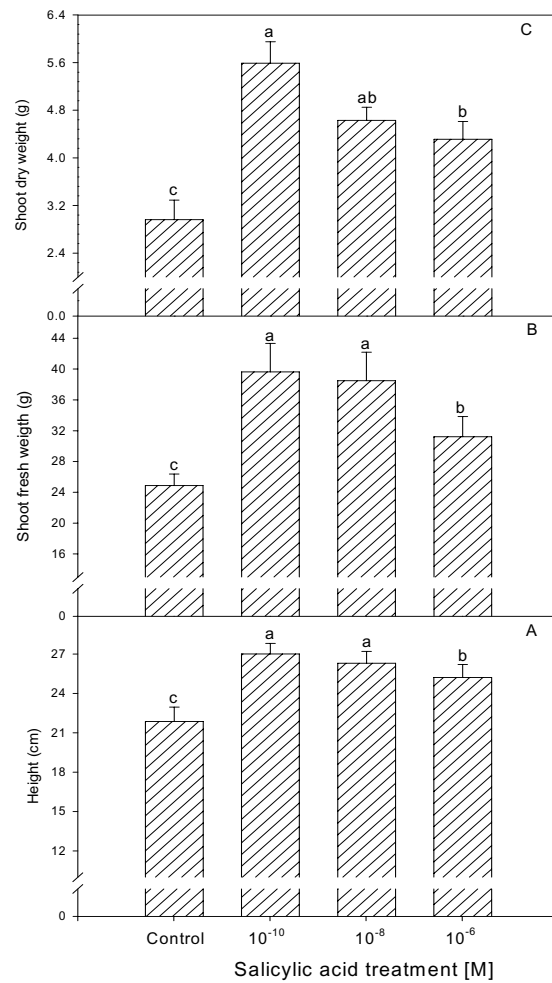

Figure 3. Effect of shoot applied salicylic acid on length (A), fresh (B) and dry mass (C) of the shoot of *Tagetes erecta*.

2.3 Effect of salicylates on flowering

The effect of salicylates on the flowering process was assessed since it is a parameter that is closely related to the productivity. In this respect, it has been reported that SA is a flower inducing factor in *Lemna* (Cleland and

Ajami, 1974). They observed that an endogenous level of SA was involved in the flowering process of this photoperiod sensitive plant.

Foliar application of SA, however, was later tested and this treatment gave promising results. One of the most conspicuous effect was the induction of the flowering. Different experiments clearly established that plants treated with SA flowered earlier than non treated plants. In ornamental species for instance such as Gloxinia (*Sinningia speciosa*), treated plants flowered at the age of 24 days whereas the control plants flowered at the age of 30 days. This effect was not known previously and had not linked with any previous hypothesis. Further experiments, using different plant species, gave similar results although no clear explanation was given for this observation (Martin-Mex *et al.*, 2003; 2005; Table 3).

Table 3. The effect of salicylic acid on the flowering of african violet, gloxinia and habanero pepper.

Plant species	Days to flower	
	Treated	Control
<i>Sainpaulia ionantha</i>	80 ± 2 a	89 ± 5 b
<i>Sinningia speciosa</i>	24 ± 1 a	30 ± 2 b
<i>Capsicum chinense</i>	36 ± 2 a	42 ± 2 b

Means with the same letter are not significantly different at $P \geq 0.05$, Tukey's

2.4 Effect of salicylates on the yield of horticultural plants

Plants treated with salicylates had higher yield in the species, cultivated either in greenhouse or in open conditions. Aristeo (1998) reported that SA induced bigger tubers in carrots (60%), beet (16%) and radish (200%). These data, collected in his preliminary work, suggested that SA could play important role in the bioproductivity of plants and that could be linked to the observed effect of promoting the root length of plants, as mentioned earlier. In recent years, commercial plantation of *Carica papaya* pre-treated with SA showed a significant increase in the fruit production, in comparison with the control. The experiment was run for over two years in order to allow the completion of the life cycle of the plant by cultivating the Maradol variety, widely planted in the Caribbean. SA is one of the growth regulators which is now in demand by the producers to enhance the papaya production by about 20% (Herrera-Tuz, 2004; Martin-Mex *et al.*, 2005). Moreover, in case of tomato, grown in green house and in open conditions, the lower

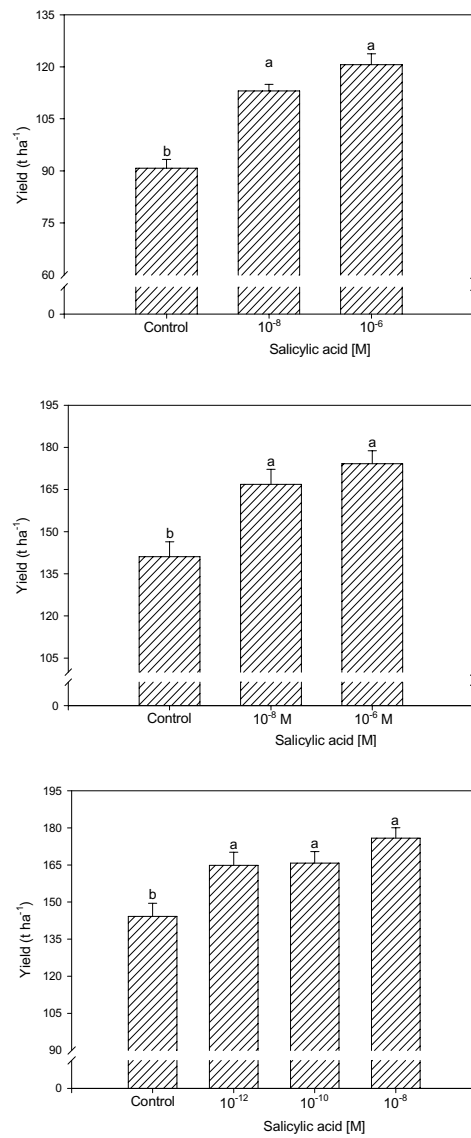

Figure 4. Effect of salicylic acid applications on the yield of *Lycopersicon esculentum* (A), *Cucumis sativum* (B) and *Carica papaya* (C).

concentration (10⁻⁶ M) of SA increased the fruit yield from 90 to 120 ton/ha in commercial plantations without affecting the quality of fruits.

This effect was reproducible in cucumber plantation, where the same concentration of SA increased the yield from 139 to 170 ton/ha and maintained the quality of the fruits (Larque-Saavedra and Martin-Mex, unpublished results; Figure 4).

It may be deduced therefore, that the bioproductivity of the horticultural plants could be improved by the application of SA. Lower concentrations of this natural plant growth hormone may also be employed on other economically important crops for better production.

3. CONCLUSION

Salicylic acid (SA) applied to the foliage of intact plants induced positive effects on the bioproductivity of horticultural and ornamental plants. Moreover, in order to get the desired effects it was observed that lower concentrations of the growth regulator are needed. The concentrations that proved best are 10^{-6} to 10^{-8} M of SA.

4. ACKNOWLEDGEMENT

Grant by CONACYT project no. 33647-B, Fundación Produce Yucatán no. 3304 and Fondo Mixto Conacyt (YUC-2004-C03-024). We thanks to Silvia Vergara and Ing. Angel Garces for help with the preparation of the manuscript.

5. REFERENCES

- Aristeo-Cortés, P., 1998. Reguladores de crecimiento XIV: Efectos del ácido salicílico y dimetilsulfóxido en el crecimiento de zanahoria, betabel y rábano. Tesis de Licenciatura. Facultad de Ciencias UNAM, México.
- Basu, R.N., Bose, T.K., Roy, B.N., and Mukhopadhyay, A., 1969. Auxin Synergist in rooting of cuttings. *Physiol. Plant.*, **22**: 649–652.
- Cleland, C. F., and Ajami, A., 1974. Identification of the flower-inducing factor isolated from aphid honeydew as being salicylic acid. *Plant Physiol.*, **54**: 904-906.
- Herrera-Tuz, R., 2004. Reguladores de crecimiento XXI. Efecto del ácido salicílico en la productividad de papaya maradol (*Carica papaya* L.). Tesis de Licenciatura. Instituto Tecnológico Agropecuario, Conkal, Yucatán, México.
- Larqué-Saavedra, A., and Wain, R. L., 1974. Abscisic acid levels in relation to drought tolerance in varieties of *Zea mays* L. *Nature*, **251** (5477): 716-717.
- Larqué-Saavedra, A., Wilkins, H., and Wain, R. L., 1975. Promotion of cress root elongation in white light by 3,5 diiodo-4-hydroxybenzoic acid. *Planta*, **126**: 269-272.

- Larqué-Saavedra, A., and Wain, R. L. 1976. Studies on plant growth-regulating substances, XLII. Abscisic acid levels as a genetic character related to drought resistance. *Ann. Appl. Biol.*, **83**: 291-297.
- Larqué-Saavedra, A., 1978. The antitranspirant effect of acetylsalicylic acid on *Phaseolus vulgaris*. *Physiol Plant.*, **43**: 126-128.
- Larqué-Saavedra, A., 1979. Studies on the effect of prostaglandins on four plant bioessay systems. *Z. Pflanzenphysiol.*, **92** (3): 263-270.
- Larqué-Saavedra, A., 1979. Stomatal closure in response to acetylsalicylic acid treatment. *Z. Pflanzenphysiol.*, **93** (4):371-375.
- Gutiérrez-Coronado, M., Trejo, C. L., and Larqué-Saavedra, A., 1998. Effects of salicylic acid on the growth of roots and shoots in soybean. *Plant. Physiol. Biochem.*, **36**: 563-565.
- Mohinder, P., Badola, K. C., and Bhandari, H. C. S., 1992. Stimulation of adventitious root regeneration of leaf shoot cuttings of neem (*Azadirachta indica*) by auxin and phenols. *Ind. J. Forest.*, **15**: 68-70.
- Martín-Mex, R., and Larqué-Saavedra, A., 2001. Effect of salicylic acid in clitoria (*Clitoria ternatea* L.) bioproductivity in Yucatan, México. 28th Annual Meeting. Plant Growth Regulation Society of America. Miami Beach Florida, USA. July 1-5, 2001. p. 97-99.
- Martín-Mex, R., Villanueva-Couoh, E., Uicab-Quijano, V., and Larqué-Saavedra, A., 2003. Positive effect of salicylic acid on the flowering of gloxinia. Proceedings 31st Annual Meeting. Plant Growth Regulation Society of America. Vancouver, Canada. August 3-6, 2003. p. 149-151.
- Martín-Mex, R., Nexticapán-Garcés, A., and Larqué-Saavedra, A., 2005. Effect of salicylic acid in sex expression in *Carica papaya* L. 10th International symposium on plant Biorregulators in Fruit Production. June 26-30 de 2005. Saltillo, Coahuila, México. p. 113.
- Martín-Mex, R., Villanueva-Couoh, E., Herrera-Campos, T., and Larqué-Saavedra, A. 2005. Positive effect of salicylates on the flowering of African violet. *Sci. Hort.*, **103**: 499-502.
- Sandoval-Yepiz, M. R., 2004. Reguladores de crecimiento XXIII: Efecto del ácido salicílico en la biomasa del cempazúchitl (*Tagetes erecta*). Tesis de Licenciatura. Instituto Tecnológico Agropecuario, Conkal, Yucatán, México.

Chapter 3

EFFECT OF SALICYLIC ACID ON SOLUTE TRANSPORT IN PLANTS

M. S. KRASAVINA

Timiryazev Institute of Plant Physiology, Russian Academy of Science, Botanicheskaya ul. 35, Moscow, RUSSIA

Abstract: The SA action on the membrane transport is its least studied physiological property. The changes in compound fluxes between the cell and the environment are, however, one of the early responses to SA treatment. Even low concentrations of SA retard potassium influx and increase that of calcium and alters proton influxes. These ion transport changes are related to the plasmalemma depolarization resulting from the loss of membrane selectivity and the activity of electrogenic pump. The data arguing for the SA-induced intercellular transport changes are also reviewed. One reason for these changes may be the reduction of plasmodesmata conductance resulting from rapid and short-lived callose deposition around the neck regions, the narrowest point of plasmodesmata. The possibility of SA influencing the callose synthase and the β -1,3-glucanase activities is discussed. The loss of plasmodesmata conductance may influence the messengers transport or the pathogens spread. The isolation of an infected cell, brought about by callose deposition is one of the earliest plant defense reaction followed by the initiation of some other defense mechanisms.

Key words: Salicylic acid, ion and pathogen transport, plasma membrane, mitochondrial membranes, plasmodesmata, cell-to-cell transport.

1. INTRODUCTION

Salicylic acid (SA) is a ubiquitous signaling molecule involved in diverse physiological processes, such as the control of flowering, seed germination, stomata functioning, gravity sensing, and pathogenesis (see reviews by Raskin, 1992; Murphy *et al.*, 1999; Alvarez, 2000; Lucas and Lee, 2004).

Endogenous SA is a key signal, involved in the activation of plant defense responses to fungal, bacterial and viral attacks. Classical studies performed on tobacco plants, infected with tobacco mosaic virus (TMV) demonstrated a substantial SA accumulation in these plants, an acquirement of resistance to subsequent infection, and the development of systemic resistance in these plants (Métraux *et al.*, 1990; Malamy *et al.*, 1990; Rasmussen *et al.*, 1991; Yalpani *et al.*, 1991). In 1990s, a correlation was found between SA content in plants and their resistance to the virus (Yalpani *et al.*, 1991, 1993). A necessity of SA for the development of plant resistance to TMV was substantiated by using transgenic plants (Gaffney *et al.*, 1993; Delaney *et al.*, 1994). Later, the involvement of SA in the development of plant resistance to other pathogens was also shown. Plant treatment with SA is one of the most efficient ways to protect plants against unfavorable biotic and abiotic environmental factors.

During recent 10–15 years, the mechanisms of SA action became more understandable. Some genes for the synthesis of SA-dependent defense proteins (PR proteins) are identified, the modes of SA involvement in the hypersensitive response (HR) and systemic acquired resistance (SAR) are elucidated, the main components of the SA signaling pathway are revealed, and the relation of this pathway to generate the reactive oxygen species (ROS) has been studied (see reviews by Alvarez, 2000; Singh *et al.*, 2004). From these studies, the role of SA as a second messenger in recognizing external signals and amplify them after their intracellular transformation becomes evident.

SA occurs not only in the cytoplasm but also in the apoplast. Plant capability of secretion of a volatile SA derivative, methylsalicylic acid, is well known, which is in agreement with SA possible extracellular localization in plant tissues. A transient SA release from its bound form and its appearance in the apoplast precedes the SA-induced expression of PR-protein genes (Hennig *et al.*, 1993). The enzyme for SA glycosylation, SA-inducible glucosyltransferase, was found in the extracellular space of tobacco leaves (Seo *et al.*, 1995). SA and its derivatives are present in various soils types; they are absorbed by plant roots and affect the uptake of other compounds. Thus, SA occurs in the apoplast of plant organs above- and underground and can affect the plasma membranes of their cells.

SA presence in the apoplast makes it useful to examine the ways of exogenous SA action on the plant-cell functioning. Cytosolic SA may be considered an exogenous one, relative to intracellular organelles. In this connection, I would like to attract the attention towards early effects of SA on membrane and to discuss its possible influence on molecule and ion transport across the plasma membrane and membranes of intracellular organelles, and to cell-to-cell transport. Since many pathogens and elicitors

exert their activities via the SA-dependent signaling pathways, SA effects will be compared with those of pathogens.

2. SALICYLIC ACID AND SOME TRANSPORT CHARACTERISTICS OF PLANT MEMBRANES

2.1 Transmembrane fluxes of ions and electrical parameters of the plasma membrane

It has long been known that phenols and SA is one of them, which influence transport of substances in plants. Phenols are exuded by roots determining the interaction of the components in the phytocenoses. If phenols affect plant species and microorganisms differently they may be considered to affect phytocenoses composition (Wang *et al.*, 1967; Shettel and Balke, 1983). Therefore, early studies on SA effects on transmembrane ion fluxes were directed to the elucidation of plant allelopathic interactions. Phenols are secreted from plant roots and washed out from leaves by rains; they are also abundant among the metabolic products of soil microorganisms. As a result, phenols accumulate in soil in substantial amounts (up to 10^{-4} M) (Whitehead, 1964). Such concentrations of benzoic and cinnamic acids and also that of SA were applied in the first studies on the effects of these compounds on ion uptake by plant roots (Glass, 1973, 1974a, 1975).

SA sharply inhibited ^{32}P and ^{86}Rb uptake by the apical parts of the roots of barley seedlings (Glass, 1973; 1974a). The lowest inhibitory concentration was 10^{-5} M, and complete inhibition was attained at 5×10^{-4} M SA. The effect was reversible and disappeared when SA was removed from the medium. The fact that SA affected both anion and cation uptake which permitted the author to conclude that its effects were unspecific (Glass, 1975). The inhibitory effect of SA on potassium uptake was confirmed by other researchers (Scharff and Perry, 1976; Harper and Balke, 1981; Gordon *et al.*, 2002). However, no damaging effects on the plasma membrane were noted.

When the effects of various phenols on transmembrane ion transport were compared, a correlation between the efficiency of this transport inhibition and the coefficient of phenol partitioning in the octane/water system was found. This permitted to presume that phenols change properties of the plasma membrane. In fact, some researchers observed changes in the membrane electrical parameters after treatments with phenols and SA in particular. Thus, Glass (1974b) demonstrated SA-induced membrane

depolarization; it was reversible and depended on the SA concentration. Other researchers also observed slight differences in the electric potentials at the inner and outer membrane surfaces. For example, Lyalin *et al.* (1986) noted a decrease in the membrane potential in submerged leaf trichomes of aqueous fern, salvinia immediately after the addition of acetylsalicylic acid (10^{-4} M) to the solution. Methylsalicylic acid manifested a strong membranotropic effect as well (Lyalin *et al.*, 1980). In this case, an active concentration was two order of magnitude lower (10^{-6} M). SA-induced plasma membrane depolarization was also observed in root cells of wheat seedlings (Gordon *et al.*, 2002).

A decrease in the electric potential difference, at the plasma membrane was accompanied by an increase in its electric resistance, which can be recorded in the cells of salvinia trichomes, after a 2-min-long latent period (Lyalin *et al.* 1980, 1986). This fact is in agreement with a decrease in the plasma membrane hydraulic conductivity found in barley roots after treatment with SA (Ktitorova *et al.*, 2006).

SA membrane effects were also observed in animal membranes and artificial phospholipid membranes. SA treatment was shown to change membrane physical properties. In the presence of SA, isolated membranes of some animal cells, neurons in particular, changed their fluidity, a temperature of a phase transition, a density of surface charges, electric capacitance and tension (Tunstall *et al.*, 1995; Balasubramanian *et al.*, 1997; Zhang *et al.*, 2001). Similar effects were observed in experiments with artificial lipid bilayer membranes (Balasubramanian *et al.*, 1997). Changed membrane properties affected the value of the membrane potential and transport activity: electrical conductivity and ion channel activity. This might be one of the reasons of disturbed cell excitability and electrical activity, which are often observed at salicylate therapy (Levitan and Barker, 1972; Zhang *et al.*, 2001; Liu and Li, 2004; Basta and Ernst, 2004). Thus, the effects of SA on plant and animal membranes are quite comparable.

2.2 Membrane transport functions during pathogenesis and at elicitor treatment

Considerable attention of plant physiologists has recently been focused on SA involvement in the signaling pathways. SA is known to be one of messengers transmitting developmental signals and those of geotropism, growth, flowering, and other processes. SA is of importance in the transduction of stress signals, in particular during pathogenesis. Many effects of cell infection are mediated by the increased level of SA.

First barrier on the way of pathogen penetration into the cell is the cell wall and plasma membrane and transmembrane ion fluxes also play an important role in the chain of primary responses to infection. In several minutes after infection, proton and calcium influxes are enhanced and that of potassium and chlorine, in contrast, are released from the cell (Atkinson *et al.*, 1985, 1990; Hahlbrock *et al.*, 1995; Jabs *et al.*, 1997). As a result, apoplastic pH and potassium concentration increase (Keppler and Baker, 1989). It is of interest that these changes in the K^+/H^+ exchange occurred only after infection with pathogens, inducing a hypersensitive response (Atkinson *et al.* 1985; Baker *et al.*, 1987).

Elicitors, produced during the attacks by bacterial, fungal, and oomycete pathogens are the first signals recognized by the receptors at the plasma membrane. Like after infection, after elicitor treatment, SA accumulates in plant cells (Conrath *et al.*, 1995). The interaction between the elicitor and its membrane receptor triggers a cascade of reactions resulting in the expression of defense genes. Rapid changes in ion fluxes play a noticeable role in the chain of such reactions.

Elicitor treatment induces similar ion fluxes as that of infection or SA treatment: enhancement of H^+/K^+ exchange at the plasma membrane accompanied by the calcium entry into the cell. For example, a fungal elicitor from *Pythium aphanidermatum* induced a rapid acceleration of potassium release and calcium influx into suspension culture of carrot cells (Bach *et al.*, 1993). Another elicitor from the *Phytophthora sojae* cell walls changed a transmembrane transport of K^+ , H^+ , Cl^- , and Ca^{2+} in parsley suspension culture (Conrath *et al.*, 1991; Nürnberger *et al.*, 1994). This changed ion flux resulted in plasma membrane depolarization (Pelissier *et al.* 1986).

The effects of stressors on ion fluxes can be exemplified by systemin action. Systemin treatment induced H^+ uptake and K^+ efflux from tomato *Lycopersicon peruvianum* suspension and leaf mesophyll cells (Felix and Boller, 1995; Moyen and Johannes, 1996). Similarly as systemin, oligogalacturonides induced the accumulation of wound-response proteins (Thain *et al.*, 1995).

Temporal activation of ion fluxes is induced by the activation of ion channels in the plasma membrane. Experiments with the modulators of ion channels indicate an important role of ion fluxes in the transduction of stress signals and in the development of plant defense responses. Thus, Schaller *et al.* introduced ionophores in the leaves of young tomato plants via the cut stems (Schaller and Oecking, 1999; Schaller and Frasson, 2001). Valinomycin, a passive potassium carrier, which dissipates a transmembrane potassium gradient, mimicked the effects of wounding and induced a rapid accumulation of wound-response gene transcripts in leaves. The effects of

nigericin and gramicidin were still more efficient; they dissipated transmembrane gradients not only of potassium but also of proton. Treatment with a channel-creating peptide gramicidin induced transcript accumulation as actively as a systemin treatment (Schaller and Oecking, 1999; Schaller and Frasson, 2001). Polyenic antibiotic amphotericin exhibited similar action: it mimicked elicitor effects on ion fluxes (Jabs *et al.*, 1997). Antibiotic interacts with membrane sterols and phospholipids, inducing ion fluxes independently of the specificity of elicitor receptors.

Alamethicin, a voltage-gated cation channel-forming peptide from *Trichoderma viride*, mimicked SA action in the induction of plant defense responses. It produces channels for monovalent cations with a slightly higher selectivity for H⁺. A treatment of lima bean (*Phaseolus lunatus*) leaves with alamethicin induced a 90-fold increase in SA content. The concentration of the SA volatile derivative, methylsalicylic acid, was also increased, resulting in the improved resistance not only of treated plant but also of neighboring ones (Engelberth *et al.*, 2001).

Anion channels are also involved in SA and elicitor effects on plant resistance; the inhibitors of anion channels blocked plant responses to elicitor treatment (Lurin *et al.*, 1996; Jabs *et al.*, 1997). Mutations in the gene encoding cyclic nucleotide-gated ion channel resulted in the loss of *Arabidopsis thaliana* plant capability of responding to avirulent *Pseudomonas syringae* strain by hypersensitivity (Clough *et al.*, 2000).

When speaking about the effects of elicitors and pathogens, I also mentioned the effects of wounding and systemin. According to current knowledge, SA is not involved in the transduction of wounding signals. It can even suppress some responses related to wounding (Doares *et al.*, 1995). However, we can see that different stimuli (pathogens, elicitors, wounding, and SA) induce similar changes in ion channels at the plasma membrane. This supports Glas idea that primary changes in ion transport are rapid but unspecific cell responses to stress. Some specificity is manifested in this action, happening *per se*. I have mentioned above that rapid changes in ion transport occur predominantly in the cases when the agent induces a hypersensitive response.

The analysis of published data concerning the effects of elicitors and SA on ion transport shows that potassium fluxes from the cell and proton and calcium fluxes into the cell attract most attention. Potassium significance in plant life is diverse. Potassium is a major intracellular cation determining its osmotic potential; potassium is required in all important processes, such as protein and nucleic acid synthesis, the activity of glycolysis and Krebs cycle enzymes, and others. Potassium partitioning between the cell and environment determines plasma membrane electrical properties: diffusion component of its membrane potential and conductivity. Control of

transmembrane potassium transport is an efficient mode to change a transmembrane difference of electric potentials (E_m) and one of the earliest cell responses to stress. Such a response may be based on the efflux through K outward rectifying channels (Demidchik *et al.*, 2003). SA was shown to activate these channels (Lurin *et al.*, 1996).

Changes in the transmembrane electrical potential, via changes in transmembrane gradients of potential-forming ions (mainly potassium and proton) are induced by SA, elicitors, or ionophores. Thus, the elicitor cryptogein disturbed ion transport and induced plasma membrane depolarization in tobacco cells (Pugin *et al.*, 1997). When tomato leaves were damaged or treated with systemin or oligogalacturonic acid, membrane depolarization occurred along with changes in ion transport (Thain *et al.*, 1990; Moyen and Johannes, 1996). A decrease in the membrane potential was also observed after the treatment of transgenic arabidopsis plants harboring the *avrRpt2* gene from *Pseudomonas syringae* pv *tomato* with dexamethasone (Pike *et al.*, 2005) and after potato cell infection with *Phytophthora infestans* (Tomiya *et al.*, 1983). The treatment of cotton cotyledons with an incompatible bacterium *Pseudomonas syringae* also resulted in plasma membrane depolarization. It was noted that, in this experiment, it occurred because of changes in the diffusion potential (Pavlovkin *et al.*, 1986).

In some experiments, a decrease in not only diffusive but also in the electrogenic component was observed (Keppler and Novacky, 1986). Melon or maize root treatment with the elicitor from the *Colletotrichum lagenarium* (melon pathogen) or from *Phytophthora parasitica* var *nicotianae* (tobacco pathogen) mycelia, respectively, induced a rapid, stable, and reversible membrane depolarization due to changes in the electrogenic component (Pelissier *et al.*, 1986).

The electrogenic component comprising of a great part of the membrane potential of plant cells is mainly created by the H^+ -pump. Significance of H^+ -ATPase activity in plant defense responses was demonstrated in experiments with the agents affecting this activity. Thus, a fungal toxin fusicochin and a plant hormone auxin activated H^+ -ATPase and simultaneously induced plasma membrane hyperpolarization. These agents suppressed the effects of wounding and systemin on H^+ transport and wounding gene expression (Doherty and Bowles, 1990; Schaller and Oecking, 1999). Moreover, in the presence of fusicochin, systemin did not induce plasma membrane depolarization (Moyen and Johannes, 1996), oligogalacturonic acid did not induced phenylalanine ammonia-lyase expression (Messiaen and von Cutsem, 1994), and cryptogein did not induce the oxidative burst in tobacco cells (Simon-Plas *et al.*, 1997). On the other hand, the inhibitors of H^+ -ATPase, like ionophores, favored the

accumulation of wound-response gene transcripts (Schaller and Oecking, 1999; Schaller and Frasson, 2001). These data permitted a conclusion that changes in membrane permeability for ions, a decrease in their transmembrane concentration gradients, and plasma membrane depolarization are necessary and sufficient for the induction of wound-response genes (Schaller and Oecking, 1999; Schaller and Frasson, 2001).

As evident from wound-response genes, the induction of PR-genes related to the SA signaling system was noted at H⁺-ATPase activation and membrane hyperpolarization (Roberts and Bowles, 1999; Schaller *et al.*, 2000). Tomato plant treatment with fusicoccin induced expression of several PR-genes: acidic chitinase (PR1), acidic glucanase (PR2), basic chitinase (PR3), and 1-aminocyclopropane-1-carboxylic acid oxidase (Roberts and Bowles, 1999). Tobacco cells constitutively accumulating bacterio-opsin, an electrogenic pump from *Halobacterium halobium* is capable of developing spontaneous necrotic-like lesions without any external stimuli (Mittler *et al.*, 1995). A *Cladosporium fulvum* avirulence factor could activate plasma membrane H⁺-ATPase and cell defense systems (Vera-Estrella *et al.*, 1994). The fact that plant defense responses are activated during either plasma membrane depolarization or its hyperpolarization, permitting Schaller and Frasson (2001) to conclude that changes in the membrane potential not only mediate the transformation of external stimuli into gene expression but its value can specifically determine which genes have to be activated at which value of the membrane potential. A conclusion derived from the analysis of the effects of factors affecting the membrane potential that SA-induced PR-gene activation should occur under conditions of membrane hyperpolarization is contrary to the facts that SA induced a decrease in transmembrane potassium fluxes and plasma membrane depolarization. In this connection, I would like to accentuate two points: (1) a complex system of signal transduction operates between the electrical potential at the plasma membrane and gene activation, which can disturb a direct correlation; (2) each treatment induces at least biphasic changes in the membrane parameters. Thus, cell response must depend on the concentration of the stimulus and duration of its action. In experiments with alamethicin treatments, SA accumulated after membrane depolarization, which argues against a strict requirement of high values of the membrane potential for expression of SA-dependent genes (Engelberth *et al.*, 2001).

The extracellular irritation of animal cells results in a rapid potassium efflux from them. In neurons, this efflux determines the origin of the action potential, a nervous impulse. A slower potassium efflux is characteristic of unexcitable cells; it is accompanied by a slow and prolonged depolarization. In plant tissues, various stimuli also result in a slow wave of membrane depolarization. Plant cell plasma membrane depolarization and the

development of a slow electrical response occurred not only at pathogenesis but also under the influence of some abiotic factors, such as salinity, chilling, mechanical stimuli (Mamulashvili *et al.*, 1973; Opritov *et al.*, 2002). Analogous responses of both plant and animal cells to stimulation indicate a similarity of the responding systems in the cells of different origin. Such notions are in accordance with the ideas expressed in classical studies by Russian scientists Ukhtomskii and Vvedenskii, who believed that the first response of each cell to stimulation is an unspecific change in its electrical properties.

Changes in proton transport are not less important for the cell than potassium fluxes. As was aforementioned, SA enhances H⁺ absorption by the cell, which results in cytosol acidification. Many bacterial and fungal elicitors also induce a decrease in the cytoplasmic pH (Strasser *et al.*, 1983; Atkinson *et al.*, 1985; Ojalvo *et al.*, 1987; Kneusel *et al.*, 1989; Mathieu *et al.*, 1996; Kuchitsu *et al.*, 1997; Roos *et al.*, 1998). In these cases, pH changes are insignificant because the buffering systems of the cell maintain pH-stat. However, even a small, transitory, and local pH reduction results in H⁺-ATPase activation and membrane hyperpolarization (Marre *et al.*, 1983; Kurkdjian and Guern, 1989; Michelet and Boutry, 1995). Another consequence of a pH decrease is the activation of ion channels – potassium, calcium, and anionic ones (Lurin *et al.*, 1996). This must affect processes related to pathogenesis. In fact, artificial cytosol acidification with weak acids activated MAPKs (Tena and Renaudin, 1998) and enhanced expression of defense genes (Lapous *et al.*, 1998; He *et al.*, 1998). These data imply an important role of cytoplasmic pH reduction occurring during stresses, at diverse stages of signal transduction. At the same time, elicitation did not ever induce cytosolic pH change (Horn *et al.*, 1992); this is expected, taking into account a large buffering capacity of the protoplasm. This capacity determines a short duration of pH changes during stresses.

Along with the influence of SA on transmembrane proton fluxes, it can otherwise affect the intracellular pH. Being a weak acid, SA enters the cell from the more acidic apoplast in the undissociated form; in the neutral cytosol, it separates proton, thus acidifying the cytosol. It was even suggested that SA partitioning between the cell and its environment could be used for intracellular pH determination (Garcia-Sancho and Sanchez, 1978). These experiments were performed with the cells of Ehrlich carcinoma, which are characterized by a low capability of transition of SA into bound form at acidic pH and a rapid equilibrium of intracellular contents and medium. Therefore, pH_i values, calculated from SA partitioning between the cell and medium, coincided with those obtained with dimethylloxalidine dione, most widely used reagent for the estimation of intracellular pH. Such an approach could not be applied to plants because SA is very rapidly

glycosylated in their cells. However, SA protonophore properties may be one more way to reduce transmembrane electrical gradients.

In spite of important role of pH in pathogenesis, many of the SA effects are not related to pH_i changes. For example, some compounds (4-hydroxybenzoic or butyric acid) reduced cytosolic pH approximately to similar values as SA but did not induce defense responses, characteristic of SA (Lebrun-Garcia *et al.*, 2002). This means that, along with an unspecific decrease in the intracellular pH, SA also induces specific defense responses in plants.

Along with potassium and proton, calcium plays an important role in signal transduction. H^+ and Ca^{2+} are widely accepted as important second messengers in the intracellular signal transduction from the cell surface to internal compartments of the cell (Guern *et al.*, 1992; Sanders *et al.*, 1999; Scott and Allen, 1999). Ca^{2+} content increases in response to diverse cell treatments. Many SA-induced defense responses in plants require the presence of extracellular Ca^{2+} . For example, calcium was required for SA-induced accumulation of chitinase in tobacco leaves (Raz and Fluhr, 1992) and in the carrot suspension culture (Schneider-Müller *et al.*, 1994). In transgenic BY-2 tobacco cells expressing aequorin, SA stimulates calcium entry into the cell (Lin *et al.*, 2005). Rapid and transitory calcium accumulation in the cytosol was also observed in yeast cells in response to SA treatment (Mori *et al.*, 1998). Changes in Ca^{2+} concentration depended on SA concentration and pH of the medium. Although high SA concentrations (1--5 mM) were used in these experiments, its action was evidently specific and did not result in any membrane injury. It was not related to cytoplasm acidification (which is possible at such concentrations of the weak acid) because similar concentrations of benzoic and sorbic acids did not induce changes in the intracellular calcium content.

Elicitors and pathogens increased the concentration of cytoplasmic calcium as well (Atkinson *et al.*, 1990; Moyer *et al.*, 1998). Although, such an increase may be explained by the cation mobilization from intracellular stores, the usage of Ca ionophore A23187 permitted a substantiation of a requirement in the transmembrane calcium fluxes for subsequent development of defense responses (O'Brien *et al.*, 1998). The treatment with this ionophore mimicked the effects of the elicitor in the induction of phytoalexin synthesis in carrot (Kurosaki *et al.*, 1987) and soybean (Stäb *et al.*, 1987) suspension cells. Ca ionophores acted similarly as increased calcium concentration in the apoplast, resulted in cation accumulation in the cell and favored activation of defense mechanisms (Suzuki *et al.*, 1995). Ca^{2+} penetration into the cell occurs through Ca^{2+} -selective channels, for example through aluminum-dependent TPC 1-type channels (Lin *et al.*, 2005). Ca^{2+} channel blockers abolished the manifestation of calcium effects:

nifedipine suppressed an elicitor-induced signal transduction (Waldmann *et al.*, 1988), whereas LaCl_3 interfered with membrane depolarization and subsequent electrolyte leakage (Pike *et al.*, 2005).

All these studies emphasize an important role of ion transport in the chain of events leading to defense responses. Change in ion fluxes is a transitory and rapid phenomenon. This is an early component of the elicitor signal transduction (Conrath *et al.*, 1991; Nürnberger *et al.*, 1994). Thus, when parsley suspension culture was treated with a *Phytophthora megasperma* oligopeptide, changes in ion fluxes were recorded within 2--5 min (Hahlbrock *et al.*, 1995). SA-induced changes in the membrane potential occurred still more rapidly (Lyalin *et al.* 1980, 1986). During longer elicitor action, unspecific changes in the membrane permeability and intracellular metabolite leakage into the apoplast occurred along with the development of necrotic lesions (Goodman, 1968; Cook and Stall, 1968; Goodman and Plurad, 1971; Keppler and Novacky, 1986).

Ion fluxes in the living cell are interdependent: activation of one ion flux affects the other ion fluxes. However, only scarce and contradictory information appeared concerning the interaction between fluxes of different ions. For example, some researchers state that Ca^{2+} uptake and its increased concentration in the cytoplasm activate channels for other ions, especially for potassium (Hedrich and Schroeder, 1989; Schroeder and Hagiwara, 1989; Tester and MacRobbie, 1990). In contrast, according to other data, Ca^{2+} channel activation and its increased concentration in the cytoplasm resulted in the inactivation of inward rectifying K^+ channels (Blatt and Grabov, 1997). Some data even indicated a stimulatory calcium effect on anion efflux from the cell (Schroeder and Hagiwara, 1989).

2.3 Salicylic acid, ion transport and reactive oxygen species

ROS accumulation is also one of the earliest plant responses to stresses affecting ion transport across the plasma membrane. Three types of ROS - superoxide (O_2^-), hydrogen peroxide (H_2O_2), and hydroxyl radical (OH^\cdot) - are critical for cells life; the effects of less active but more stable hydrogen peroxide and hydroxyl radicals are better studied. Like H^+ and Ca^{2+} , ROS are second messengers in diverse signaling pathways (Prasad *et al.*, 1994; Alvarez *et al.*, 1998; Sanders *et al.*, 1999; Neill *et al.*, 2002) and in the activation of numerous cell responses (Levine *et al.*, 1994; Dat *et al.*, 1998; Bowler and Fluhr, 2000).

SA action is tightly related to the generation of various ROS (Kauss and Jeblick, 1995; Rao *et al.*, 1997; Anderson *et al.*, 1998; Kawano *et al.*, 1998; Kawano and Muto, 2000). This is especially important when ROS are

produced at the infection sites because they can activate apoptotic processes and pathogen death (Yang *et al.*, 2004). In its turn, peroxide treatment results in the activation of SA synthesis (León *et al.*, 1995). SA and ROS manifest additivity in the control of many cellular processes (Jabs, 1999; Alvarez, 2000). SA and ROS similarly affect respiratory parameters and mitochondrial protein composition (Robson and Vanlerberghe, 2002). On the other hand, the interaction between SA and ROS is ambiguous. By interacting with Fe, SA can acquire superoxide dismutase activity and function as an antioxidant (Jay *et al.*, 1999). It can protect catalase from inactivation *in vitro* and reduced H₂O₂ accumulation (Durner and Klessig, 1996). On the other hand, at the action of some biotic and abiotic agents, SA can suppress ROS generation (Castagne *et al.*, 1999; Yang *et al.*, 2004).

ROS are produced in all cell compartments and in the apoplast and affect membrane properties. For example, an increased H₂O₂ concentration near the plasma membrane, induced by chilling, reduces a hydraulic conductivity of the plasma membrane of the root cells (Lee *et al.*, 2004).

Many elicitors activate NADPH oxidase and enhance ROS generation. H₂O₂ can induce PR-gene expression like elicitors. Cell treatment by a Ca²⁺-agonist (BAYK-8644) resulted in hydrogen peroxide accumulation by inducing the expression of the gene encoding glutathione-S-transferase, the component of ROS signaling pathway (Clayton *et al.*, 1999).

Changes in transmembrane ion fluxes accompanying SA, pathogen, and elicitor action are required for ROS generation. In this aspect, calcium ions are especially important, for example for the activation of plasma membrane NADPH oxidase, a major source of extracellular ROS. Ca channel activation is involved in the induction of ROS generation; their inhibition retards the process. In its turn, hydrogen peroxide activates Ca channels, enhancing further Ca uptake by the cell (MacRobbie, 1999; Pei *et al.*, 2000; Murata *et al.*, 2001; Sanders *et al.*, 2002) and its accumulation (Price *et al.*, 1994; Rentel and Knight, 2004). ROS treatment of the *rhd2* arabidopsis mutant, incapable of environmental Ca uptake, activated Ca channels and suppressed a defective phenotype (Foreman *et al.*, 2003).

ROS affect other ion channels as well. Thus, hydrogen peroxide treatment was shown to inactivate inward-rectifying K⁺ channels (Zhang *et al.*, 2001b). Hydroxyl radical activated K⁺ outward rectifier channels, which results in potassium efflux (Demidchik *et al.*, 2003). A decrease in potassium uptake and its enhanced release result in a declined intracellular potassium concentration, which we observed after all external signals action.

In the presence of hydrogen peroxide, proton fluxes change, induced cytosol alkalization (Zhang *et al.*, 2001a). A possible reason for this phenomenon might be the inhibition of plasmalemmal H⁺-ATPase due to

disturbed association of H⁺-ATPase and 14-3-3 proteins under ROS effect (Zhang *et al.*, 2004).

Thus, SA, pathogens, elicitors, and ROS affect ion transport in a similar manner, suggesting a tight relation between their action mechanisms.

2.4 Salicylic acid and transport functions of mitochondrial membranes

SA affects substance fluxes not only across the plasma membrane but also across the membranes of organelles. The effects of SA on mitochondrial membrane functioning are most studied. Similarly as in the plasma membrane, protonophore properties of SA, its effects on transport of potential-producing ions resulted in membrane potential dissipation in mitochondria. After SA treatment, electron transport along the cytochrome oxidase pathway was disturbed, oxidative phosphorylation was uncoupled, and the ATP content in the cells declined (Macri *et al.*, 1986; Maxwell *et al.*, 2002). These processes affected the rate of oxygen uptake by the cells and isolated mitochondria. Most data obtained indicate that, in association with suppressed ATP generation, oxygen uptake by tobacco cells was also inhibited (Xie and Chen, 1999). However, some observations demonstrated a dependence of the direction of respiratory changes on SA concentration. Thus, administration of low SA concentrations (0.01--0.1 mM) into the medium of tobacco suspension culture activated cell respiration; inhibition was observed only at higher concentrations. Similar dependence was manifested in isolated mitochondria as well (Norman *et al.*, 2004).

Mitochondria are the most active ROS generators in the cells. SA-induced disturbance of respiration in mitochondria resulted in ROS accumulation in tobacco suspension cells; pretreatment with antioxidants blocked this accumulation (Maxwell *et al.*, 2002). One of the causes for ROS accumulation is an insufficient rate of respiratory substrate oxidation in the cytochrome oxidase pathway of electron transport. Therefore, the inhibitors of this pathway (antimycin A and cyanide) enhance ROS accumulation. SA acts similarly (Chen *et al.*, 1993).

Along with the cytochrome oxidase pathway, one more specific electron transport pathway operates in plants; it involves alternative oxidase (AOX). AOX directs the electrons from ubiquinone directly to oxygen, bypassing two points of coupling with phosphorylation. It functions usually under conditions of a low activity of the basic cytochrome oxidase electron transport chain in the mitochondrial membrane, maintaining the rate of electron transport and providing rapid oxidation of respiratory substrates. Alternative pathway of oxidation interferes with excessive ROS accumulation. SA is well known to induce *Aox 1* gene, encoding alternative

oxidase (Rhoads and McIntosh, 1992, 1993). Thus, on the one hand, SA inhibits electron transport, favoring ROS accumulation, and, on the other hand, it activates AOX retarding this process. This demonstrates a necessity for a strict control of ROS concentration in mitochondria.

ROS (superoxide, hydrogen peroxide, and hydroxyl radical) induce plant defense responses. Therefore, the inhibition of electron transport by SA, antimycin A, or cyanide, which increased ROS content, improved tobacco plant resistance to TMV without the activation of PR-protein synthesis (Chivasa and Carr, 1998; Wong *et al.*, 2002). Enhanced ROS generation is another mode of resistance improvement, distinct from PR-protein synthesis, including SA activity. Since the extent of ROS accumulation is under the control of alternative pathway of electron transport, superactive AOX reduces plant resistance toward the virus, whereas a decrease in AOX activity increases resistance (Gilliland *et al.*, 2003).

A hypersensitive response plays an important role in plant defense against stress factors, resulting in the appearance of necrotic lesions. HR is manifested in plants harboring the N gene when they are infected by avirulent pathogen strain. HR is a kind of cell death. The programmed cell death (PCD) of animal cells is studied in more detail than plant HR. A characteristic feature of PCD in animals is the release of cytochrome *c* and some other photogenic factors from mitochondria. These factors released through the, so-called mitochondrial permeability transition pores (PTP), which are formed due to the interaction of the adenine nucleotide translocase, a protein located in the inner membrane, and some proteins of outer membrane, for example, some unspecific components of anion channels. This interaction occurs via a protein of the intermembrane space cyclophilin D. Each of these proteins fulfils its own well-known functions: voltage-dependent anion channel (VDAC) mediates transport of low-molecular-weight compounds between the cytosol and mitochondrial inner membrane; adenine nucleotide translocase (ANT) provides for an ADP/ATP exchange required for energetic processes; cyclophilin D (CyP-D) might be involved in folding/unfolding of transported molecules. All these components can produce easily and rapidly the complexes of variable conductivity.

Among possible reasons to explain the increased permeability of such pores, their "opening", are oxidative burst, increased content of inorganic phosphate and Ca^{2+} in the cytosol, and increased pH (Jones *et al.*, 2000; Kim *et al.*, 2003). Proteins belonging to the Bcl-2 family occupy an important place in the regulation of pore permeability. Some of these proteins counteract PCD triggering and favour cell survival by blocking caspase activity. Other proteins from this family fulfill opposite function: they accelerate cell death. Proapoptotic members of this family (Bax, Bad, Bak,

and Bid) stimulate the formation of leakage channels in the outer mitochondrial membrane and open PNP; antiapoptotic proteins (Bcl-2, Bcl-X), in contrast, close these pores and stabilize membranes (Marzo *et al.*, 1998; Adams and Corey, 2001; Robson and Vanlerberghe, 2002). BAX-like proteins can inactivate antiapoptotic proteins by the formation of heterodimers Bcl-2/BAX (Lacomme and Santa Cruz, 1999). Another way of BAX activity is the induced disturbance in the transport functions of mitochondrial membranes by interacting with adenine nucleotide translocase.

Increased permeability of PTP might caused cytochrome *c* release from mitochondria and its appearance in the cytoplasm (Liu *et al.*, 1996; Li *et al.*, 1997; Cai and Jones, 1998; Desagher and Martinon, 2000). Proapoptotic Bcl-2 proteins facilitates this release, and antiapoptotic proteins prevent it (Adams and Corey, 2001). Cytochrome *c* release normally translocates electrons from cytochrome reductase to cytochrome oxidase that inhibits respiration. Membrane potential is dissipated, respiratory control is lost, electron transport and phosphorylation are uncoupled, and mitochondria accumulate calcium. The addition of exogenous cytochrome *c*, at early stages of these disturbances, restores normal mitochondria functioning (Mootha *et al.*, 2001).

Cytochrome *c* released from mitochondria interacts with some cytosolic proteases (caspases), to activate them and finally result in the degradation of cell structure (Li *et al.*, 1997; Green and Reed, 1998; Susin *et al.*, 1998; Li *et al.*, 2000). Simultaneously with cytochrome *c*, mitochondria also release a complex of apoptogenic compounds, including AIF, a factor of apoptosis induction (see review by Kim *et al.*, 2003).

It should be noted that an increase in the permeability of the mitochondrial membrane could occur in the absence of some components, normally involved in PTP formation. For example, channels can function without cyclophilin D or without adenine nucleotide translocator (Forte and Bernardi, 2005). In the establishment of the pathways for mitochondrial membrane permeability, other components may be involved, which are not related to PTP formation. For example, cytochrome *c* can be released from isolated mitochondria, before PTP formation (Wei *et al.*, 2000; von Ahsen *et al.*, 2000). In addition, some stages of cell death come to existence without caspase activation (Mootha *et al.*, 2001; Koumura *et al.*, 2005).

It is of interest that the extent of mitochondrial provision of ATP affects the character of the cell death. When ATP stores are exhausted, apoptosis is blocked. Instead, the same apoptogenic signals induce somewhat different type of death resembling necrosis (Kim *et al.*, 2003).

It seems likely that the mechanisms of cell death are similar in plant and animal. Some observations indicate that the classical mitochondrial

permeability transition occurs also in plants. In plant mitochondria, pores were found with characteristics resembled to those of animal mitochondrial pores (Arpagaus *et al.*, 2002). Similarly, as in animal cells, oxidative burst disrupts mitochondrial membranes and permits the release of cytochrome *c* from plant mitochondria (Tiwari *et al.*, 2002). Cytochrome *c* released from cucumber mitochondria, subjected to heat shock (Balk *et al.*, 1999) and from tobacco protoplasts, treated with menadione (Sun *et al.*, 1999) was also observed. Although no faithful identification of plant proteins composing of plant mitochondrial pores has been performed (Assaad, 2001) but some analogs of animal mitochondrial proteins are found in plants, for example caspase-like proteins (Korthout *et al.*, 2000). Caspase inhibitors from animal cells prevent the development of HR in plants, infected by pathogens (Del Pozo and Lam, 1998). On the other hand, some animal cancer cells treated with the extract from *Gleditsia sinensis* fruits exhibited apoptotic features (Chui *et al.*, 2005). A similarity in the PTP involvement in the induction of cell death in plant and animal cells is confirmed by experiments with a BAX:GFP fusion protein (BAX is an inducer of apoptosis in animal cells). Infection of *Nicotiana benthamiana* (genotype nn incapable of necrotic lesion formation) plants with a TMV-based vector harboring murine *bax* cDNA encoding an apoptogenic protein in animal cells induced localized tissue collapse and cell death type, resembling to plant HR. Cell death induction was accompanied by the accumulation of a defense PR1 protein, characteristic of HR. Since Bax:GFP was located in mitochondria, it was supposed that this protein functions in plant mitochondria in a similar way as in animal mitochondria by controlling membrane permeability and releasing cytochrome *c*, thus affecting nuclear gene expression (Lacomme and Santa Cruz, 1999). A similarity in functioning of plant and animal mitochondrial membranes was demonstrated also in experiments with another inhibitor of transmembrane transport, bongkreikic acid. This inhibitor binds to the PTP and prevents H₂O₂-apoptosis in animal and human cells (Dumont *et al.*, 1999). Treatment of tobacco cell suspension with bongkreikic acid did not affect gene expression. However, treatment with this acid before SA treatment completely abolished the SA-induced expression of *Aox 1* gene (Maxwell *et al.*, 2002). This implies that SA did not affect the direct expression of the gene encoding alternative oxidase but operates via a disturbance in mitochondrial membrane transport properties. Mitochondria evidently are not the only center for integration of diverse stress signals but also transmit these signals to the nucleus, thus controlling gene expression. The mitochondrial pore complex can regulate its conductivity: pore transitory opening increases its permeability, transmitting regulatory molecules inside and releasing metabolic intermediates into the cytosol. Such transitory changes in mitochondrial pore permeability are evidently

required for the interaction between organelles: mitochondria, cytosol, and nucleus (Maxwell *et al.*, 2002).

I have considered the functioning of mitochondrial pore complex so fully because I deduce a similarity in the control of its permeability and the routes of plant cell-to-cell transport, which will be discussed below. A transitory increase in the mitochondrial pore complex permeability resembles the control of the animal cell gap junction or plant plasmodesmata by the endogenous or exogenous factors (for example, an increase in the plasmodesmata permeability under the effect of viral proteins, TMV movement protein in particular). The involvement of SA in the functioning of mitochondrial PTP may only be expected and investigations in this direction seem promising.

2.5 Phytoalexin synthesis, their secretion and pathogenesis virulence factors

Changes in ion fluxes in response to infection, elicitors and SA treatment resulted in the activation of synthesis and secretion, in the apoplast, of phytoalexins, compounds with antipathogen action. Phytoalexin secretion is an important step in the development of plant defense responses. Derivatives of coumarin and cell-wall phenols are among phytoalexins, produced during pathogenesis (Nürnberg *et al.*, 1994; Jabs *et al.*, 1997). Like elicitors, SA and its active analogue are shown to activate enzymes for coumarin biosynthesis and also enhance its secretion by the cell (Hahlbrock and Scheel, 1989; Kauss *et al.*, 1992). Thus, not only ion transport but also transport of larger molecules may be under SA control.

Along with the effects on the components of the plant defense system, SA can affect excretion of pathogen virulence factors. For example, exogenous SA reduced the capability of *Pseudomonas aeruginosa* to attach to arabidopsis roots. In addition, it suppressed the synthesis and secretion of bacterial protease, elastase, and pyocyanin (Prithiviraj *et al.*, 2005). Thus, outside the role of SA as a signal molecule, it can manifest anti-infectious action on pathogen physiology, weakening its virulence (Prithiviraj *et al.*, 2005). Experiments, demonstrating a direct inhibitory action of SA on pathogen spores (Lapikova *et al.* 2000) argue for this possibility as well.

2.6 Salicylic acid potentiates elicitor action

A novel aspect of SA action on transport processes was highlighted in experiments on plant-cell defense responses to varying amounts of pathogens or elicitors. Along with the direct action of SA on ion fluxes, it can enhance their changes during subsequent treatment with elicitors (Katz

et al., 2002). Cell pretreatment with 10--500 μM SA increased cell sensitivity to elicitor oligopeptide Pep-13: induction of K^+/H^+ fluxes at the plasma membrane and subsequent coumarin secretion, occur at lower concentrations of elicitor.

SA also potentiated metabolic changes in infected plants. SA treatment before cucumber infection with *Colletotrichum lagenarium* enhanced phenol deposition in the cell walls of systemically resistant tissues and activated chitinase and peroxidases in them (Siegrist *et al.*, 1994). SA treatment before the infection of parsley suspension with fungal pathogen *Phytophthora megasperma* f.sp. *glycinea* enhanced expression of the genes encoding phenylalanine ammonia-lyase, 4-coumarate:CoA ligase, hydroxyproline-rich glycoprotein, and PR-10 (Thulke and Conrath, 1998). Pretreatment of tobacco leaf surface with SA turned out to be useful for the induction of defense genes after pathogen attack (Mur *et al.*, 1996). A functional SA analog benzothiazole also exhibited a potentiating effect (Katz *et al.*, 1998).

Finishing the description of the effect of SA and related compounds on the transport of ions and some organic substances, it should be emphasized here that SA-induced changes in membrane electrical parameters, therefore, transport properties of the membrane are the early rapid responses to a treatment. A short duration of induced changes in ion fluxes indicate their signaling function and similarity in the direction of action of SA, elicitor, and pathogen indicates common mechanism. The fact that similar changes occurred in ROS that shows the involvement of ROS in the system of signal transduction. Changes in ion transport are evidently the first signals in response to adverse environmental conditions, indicating a requirement in directed cell responses. Further investigations have to elucidate that how the cell recognizes such a SOS signals.

3. SALICYLIC ACID AND INTERCELLULAR TRANSPORT THROUGH PLASMODESMATA

The functionally related plant cells are interconnected via plant-specific structures, plasmodesmata. Primary plasmodesmata originate during cytokinesis within the cell plate of the dividing cell; secondary plasmodesmata are inserted in the mature cell wall (Ehlers and Kollmann, 2001). Plasmodesmata perform a direct connection between the neighboring cells via continued plasma membrane, endoplasmic reticulum appressed into the desmotubule, and cytoplasmic annulus (see reviews Lucas *et al.*, 1994; Lucas and Lee, 2004; Zambryski and Crawford, 1995; Scholthof, 2005). Plasmodesmatal conductivity is higher than that of plasma membrane. Therefore, they are important routes for cell-to-cell communications. Ions

and organic metabolites, including assimilates, hormones, and other signal molecules are transported through plasmodesmata.

As distinct from animal gap junctions and probably mitochondrial permeability transition pores, plasmodesmata are stable structures. However, like in gap junctions and mitochondrial permeability transition pores, plasmodesmatal conductivity is controlled. Most plasmodesmata permit the penetration of molecules not exceeding 1 kDa. However, some factors can decrease or increase their size exclusion limit (SEL). In these cases, plasmodesmata are closed or opened, so that macromolecules can also be transported through such open (or gate) plasmodesmata.

Viruses and most other pathogens spread through plasmodesmatal connections. For this, they synthesize special movement proteins (MP), which are capable of increasing plasmodesmal SEL. Transported viral nucleic acid is unfolded, facilitating translocation of MP--vRNA complex through the plasmodesmal transport channel (Wolf *et al.*, 1989; Waigmann *et al.*, 1994; Oparka, 2004). Some plant proteins were found, which are immunologically related to viral MP and are also capable to change plasmodesmata permeability, thus controlling the transport of macromolecules and possibly restricting pathogen from spreading. It is unknown whether SA is involved in the control of this transport; however, some evidences indicate such an involvement.

3.1 Effect of salicylic acid on cell-to-cell substance transport

Volume of data indicates that SA treatment reduces the number of necrotic lesions on the leaves of plants harboring the *N* gene and infected with pathogens. Simultaneously, a decrease in the size of these lesions was noted (Enyedi *et al.*, 1992). In transgenic plants, expressing the bacterial *NahG* gene, TMV infection-induced lesions were larger than lesions in the wild-type tobacco (Gaffney *et al.*, 1993; Delaney *et al.*, 1994). Salicylate hydroxylase degrades SA to catechol, preventing SA accumulation during infection development. In this type of studies, SA treatment was usually performed several days before infection, and necrotic lesions were characterized several days after inoculation. Such a long action of SA implies the initiation of some metabolic changes, such as the synthesis of PR-proteins and phytoalexins (Klessig and Malamy, 1994). These changes can finally result in a decrease in the number of necrotic lesions.

SA-induced suppression of virus replication and its cell-to-cell transport may be one of the direct causes for inhibited necrosis development. Some of the data proves that SA can inhibit virus replication, which immediately affects the number of necrotic lesions. In fact, in the sensitive TMV tobacco

nm genotype, SA retarded the accumulation of viral RNA (vRNA), RNA-dependent RNA polymerase, and TMV coat protein at infected sites (Chivasa *et al.*, 1997; Naylor *et al.*, 1998). For some other viruses (for example, potato virus X, turnip vein clearing virus), it was also shown that SA inhibited the accumulation of viral RNA or viral particles (Naylor *et al.*, 1998; Wong *et al.*, 2002). In experiments with tobacco plants, a tissue-specificity of SA action on virus replication was demonstrated. SA reduced the content of vRNA in the mesophyll cells but did not affect or affected only weakly, the virus replication in the epidermis (Murphy and Carr, 2002). Nevertheless, SA suppressed virus transport from the primarily infected epidermal cell to neighboring epidermal cells (Murphy and Carr, 2002). In this case, the second aspect of SA action on virus spreading seems quite evident.

Until now, the mechanism of SA action on substance transport through plasmodesmata remains undisclosed. In the above-cited work by Murphy and Carr, the inhibition of TMV translocation between neighboring epidermal cells cannot be explained because of a reduced permeability of plasmodesmata; in contrast, plasmodesmal SEL even increased, permitting a greater number of dextrane molecules, 3 kDa in size to be transported from the inoculated cell to neighboring ones. However, the molecules of 10 kDa, comparable in size with viral transport complex, could not be transported either in the presence or in the absence of SA. SA did not affect the capability of viral movement protein to increase plasmodesmata permeability (Murphy and Carr, 2002).

It should be noted that, in aforementioned study as well in earlier investigations, SA treatment was performed five days before inoculation with the virus. In this connection, it is of interest to recall the observations made by Mur and others. The authors used the salicylate hydrolase gene (*SH-L*) from *P. putida*; its expression did not result in catechol production, which interferes with the interpretation of results obtained on *NahG* plants. They inserted this gene into the tobacco (cv. Samsun) genome under the control of various promoters and, in this way, retarded SA accumulation during different stages of development of TMV infection. The authors found that only early expression of the *SH-L* gene could affect virus spreading, and only early accumulation of SA could interfere with infection development (Mur *et al.*, 1997).

In the study performed on submerged leaf trichomes of aquatic fern *Salvinia auriculata*, primary SA effects on plasmodesmal electrical conductivity were examined. A short-term (4 min) treatment with SA induced a biphasic response. Immediately after SA addition to medium, a transitory increase in plasmodesmal conductivity was observed along with membrane depolarization. Thereafter, conductivity decreased sharply up to

its complete disappearance, indicating plasmodesmata closing (Lyalin *et al.*, 1986). Similar data were obtained for sucrose accumulation in maize root tips treated with SA. Sucrose was synthesized in scutellum cells from the applied

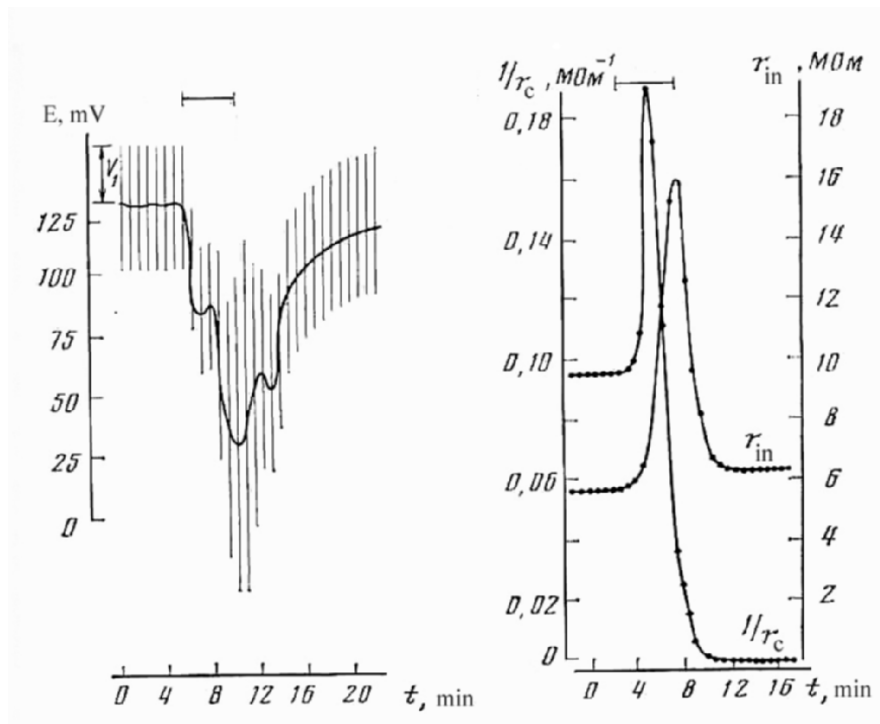

Figure 1. Effect of 4 min treatment with SA on membrane potential and plasmodesmatal conductivity of a submerged leaf trichome of *Salvinia*. Left - the membrane potentials and the potential shifts following a series of 2s-long 7nA electric pulses applied at 1.5 pulse/min frequency; the shift value reflects the membrane resistance. Right - the changes of the membrane resistance r_{in} and of the intercellular electric conductivity $1/r_c$. The line overhead corresponds to duration of SA action. Modified from Lyalin *et al.*, 1986.

deoxyglucose and transported to the root through the phloem. In this case, we also observed a biphasic response, although it had other temporal characteristics. During the first hour, sucrose inflow to the root parenchyma cells increased; however, in the later hours, it got retarded (Krasavina *et al.*, in press). SA effects depended on its concentration: at the concentrations exceeding 0.1 mM, we did not observe any stimulation in sucrose transport. In the root tips, assimilate efflux from the phloem and their partitioning among the cells is known to occur along the symplast; therefore, sucrose

influx to sink cells can be considered a measure for plasmodesmatal conductivity.

One of the possible reasons to defend the SA-induced changes in plasmodesmata conductivity might be its action on the cytoskeleton. In plasmodesmata, the main cytoskeletal components were actin (White *et al.*, 1994; Blackman and Overall, 1998; Krasavina *et al.*, 1998), myosin-like proteins (Blackman and Overall, 1998; Radford and White, 1998), plant-specific myosin VIII (Reichelt *et al.*, 1999). Therefore, actomyosin system might be involved in cell-to-cell transport along plasmodesmata (Baluška *et al.*, 2004). The inhibitor of the actin cytoskeleton cytochalasin increased plasmodesmal SEL in tobacco leaves (Ding *et al.*, 1996) and reduced plasmodesmata electrical resistance in the root of aquatic higher plant *Trianea bogotensis* and trichomes of fern *Salvinia* (Krasavina *et al.*, 2001). According to Roberts and Oparka, actin filaments may form a scaffold within plasmodesmata, along which some substances may move using a myosin-based motor (Roberts and Oparka, 2003). However, it is unknown whether SA is involved in the control of the actomyosin system functioning.

The interrelation between SA and Ca^{2+} -dependent cytoskeletal components is more understandable: a SA-induced increase in the content of intracellular calcium might change their activity. Among Ca^{2+} -dependent contractile elements in plasmodesmata, centrin, a calcium-binding contractile protein (Baluška *et al.*, 1999; Blackman *et al.*, 1999), and in the cortical endoplasmic reticulum, the calcium-sequestering protein calreticulin (Baluška *et al.*, 1999, 2001) were found. It might be that increased calcium concentration affected these components of plasmodesmata (Tucker 1990; Holdaway-Clarke *et al.*, 2000).

Calcium can evidently affect plasmodesmal conductivity by different ways. Aside its effects on the cytoskeleton, calcium can operate via Ca^{2+} -dependent protein kinase co-localized with plasmodesmata (Yahalom *et al.*, 1998) and involved in phosphorylation of membrane components. For example, activation of NADPH oxidase requires Ca^{2+} -dependent phosphorylation. It is also known that the activity of some regulators of plasmodesmal permeability including viral movement protein depend on phosphorylation/dephosphorylation (Citovsky *et al.*, 1993; Matsushita *et al.*, 2000, 2002; Oparka, 2004). SA can affect phosphorylation via some protein kinases. Thus, in tobacco cells, salicylic acid dependent activity of protein kinase (SIPK) was rapidly induced. SA induced a phosphorylation-dependent step in the HR signaling pathway. SA-dependent protein phosphorylation is required for the expression of plant defense genes and for activation of transcription factors.

Another consequence of calcium accumulation in the cortical cytoplasmic layer in the presence of SA might be the changes in the content of callose, near plasmodesmata.

3.2 Callose, plasmodesmata and cell-to-cell substance transport

In most cases, plasmodesmal diameter differs along its length. Usually, the plasmodesmata get narrow at the site of their exit from the cell wall, so-called neck region. The regulation of plasmodesmata permeability is most easily exerted by controlling the diameter of this region. Constricted neck-region is surrounded by an electron-transparent collar located in the cell wall, outside of the plasmodesmata. This region is usually called external sphincter; the capability of reducing a plasmodesmal conducting channel is often ascribed to this structure (Olesen and Robards, 1990; Badelt *et al.*, 1994). Callose is believed to be deposited just at these sites. Callose deposition around plasmodesmata was confirmed immunochemically (Northcote *et al.*, 1989; Delmer *et al.*, 1993).

It is known since long that callose deposition is rapid and only sensitive cells respond to any external factor (Shimoura and Dijkstra, 1975). Mechanical pressing, ultrasound, chilling, heating, and cell injury induce callose deposition (Curier and Webster, 1964; McNairn, 1972). Even tissue cutting and routine fixation used for electron microscopy can induce callose deposition near plasmodesmata (Radford *et al.*, 1998). However, callose deposition is not only a stress response. Callose is of importance during normal cell development and functioning: cell division, cell plate formation, sieve pore development, protonema differentiation, seed germination, pollen development and maturation.

A correlation was found between callose deposition and assimilate transport in plants. Thus, callose deposition on sieve plates is activated after sieve element damage (Eschrich, 1965; McNairn, 1972). In such a way, some sieve tubes are temporarily excluded from assimilate transport; for example, damaged sieve tubes, sieve tubes not functioning in winter or not coping with a rapid assimilate flow. This respond is rapid and reversible: when the damaging factor is removed, callose disappears. A maize *sxd1* mutant defective in sucrose export was characterized by enhanced callose deposition in conducting tissues of source leaves, positioned between the bundle sheath and vascular parenchymatous cells (Botha *et al.*, 2000). It might be that just callose retards assimilate loading into the phloem of this mutant (Hofius *et al.*, 2004). Callose deposition in cell wall can suppress not only symplastic transport but also prevents the transport inside the apoplast.

It seems likely that common elements occur in the control of plasmodesmal conductivity for low-molecular-weight compounds, macromolecules, and pathogens. Therefore, callose deposition prevents pathogen transport as well. Local callose deposition may constrict the neck region of plasmodesmata, reduce their permeability, thus preventing infection spreading (Botha and Cross, 2000; Roberts and Oparka, 2003). The intracellular content of callose is known to increase during pathogen attack; callose deposits around plasmodesmata and disturbs cell-to-cell transport of pathogens (Delmer *et al.*, 1993; Radford, 1998). Firstly, callose deposits near plasmodesmata, closing them (Tucker and Boss, 1996; Clarke, 1996) and then it covers the entire surface of damaged cells, thus isolating the damaged loci (Wu and Dimitman, 1970; Shimomura and Dijkstra, 1975; Donofrio and Delaney, 2001). In the presence of callose, the long-distance trafficking of viruses (Leisner and Turgeon, 1993), oomycete *Phytophthora sojae* (Enkerli *et al.*, 1997), and fungal pathogens (Bailey *et al.*, 1990) is also suppressed.

3.3 Putative involvement of salicylic acid in the control of callose content in plant cells

3.3.1 Salicylic acid and callose synthesis

Callose is a polymer of β -1,3-linked glucose residues. Its synthesis is catalyzed by plasma membrane bound β -glucan synthase (callose synthase), a transmembrane protein transferring glucose from uridinediphosphate glucose, synthesized by sucrose synthase, to the oligosaccharide chain positioned at the outer surface of the plasma membrane. The intracellular content of callose can be controlled by some agents, such as detergents, polycations interacting with phospholipids (polymyxin B, phospholipase), that is, by affecting membrane fluidity (Köhle *et al.*, 1985). Some hormones, for example abiotic stress hormone ABA, also affect the content of callose (Ton and Mauch-Mani, 2004).

Inositide triphosphate (IP_3), activated by G-protein, markedly affects callose synthesis. IP_3 induces callose synthesis via its action on calcium channels and to facilitate calcium influx into the cell. Calcium is quite necessary for callose synthesis, most probably because of its direct action on calcium-sensitive callose synthase (Köhle *et al.*, 1985; Kauss and Jeblick, 1985, 1986a, 1986b; Kauss, 1985, 1987). In the presence of EDTA, a chelating agent, callose deposition is sharply reduced (Eschrich, 1965; Köhle *et al.*, 1985). The inhibitors of Ca^{2+} channels, nifedipin and gadolinium, also block callose synthesis (Kartusch, 2003).

SA and stresses activate callose synthesis due to the induction of calcium influx into the cell and its increased concentration in the cortical cytoplasm layer (Kauss, 1985, 1987; Bhuja *et al.*, 2004). In 2 h after treating the arabidopsis plant with SA, the content of *AtGSL5* mRNA increased; the *AtGSL5* gene encodes a protein homologous to the catalytic subunit of β -1,3-glucan synthase (Østergaard *et al.*, 2002). This increase in mRNA content was transient; after 16 h, it decreased to the initial level even in the presence of SA for the whole duration. The *mpk 4* mutant, characterized by constitutive systemic acquired resistance and an intense accumulation of SA, accumulated a great amount of *AtGSL5* transcript (Petersen *et al.*, 2000). Simultaneously, the activity of β -1,3-glucan synthase increased, and callose accumulated in this mutant (Østergaard *et al.*, 2002). When plant contained simultaneously the *mpk 4* mutation and the bacterial *NahG* gene preventing SA accumulation, the synthesis of *AtGSL5* mRNA was suppressed. This indicates a requirement of SA for the functioning of *AtGSL5* gene.

A rapidity in the activation of callose synthase after spraying the arabidopsis plant with SA implies a possibility that SA affects callose deposition on the cell surface (Østergaard *et al.*, 2002). In fact, the treatment of tobacco leaves or epidermal stripes with SA (Fig. 2) resulted in the appearance of fluorescing callose spots in the cell walls (Krasavina *et al.*, 2002). The appearance of such fluorescence is often used for detecting plasmodesmata localization (see, for example, Baluška *et al.*, 1999). Callose deposition became evident as early as after 1h of SA treatment; the response was reversible, and callose disappeared after SA removal. Enhanced callose deposition in the presence of SA, detected cytochemically, was confirmed by callose content, quantificatied in tobacco leaves (Serova *et al.*, 2006).

A significance of SA-dependent callose deposition in plant resistance was substantiated in experiments with *Pseudomonas syringae* harboring the mutated *CEL* gene (DebRoy *et al.*, 2004). This gene encodes bacterial effectors suppressing plant SA-dependent defense responses. When arabidopsis leaves were infected with this bacterial mutant, less necrotic lesions appeared and the content of callose increased markedly (by an order of magnitude). However, when plant expressed the *NahG* gene, the content of callose remained unchanged. This indicated the occurrence of the SA-dependent defense system mediated by the callose synthesis in plant cell wall (DebRoy *et al.*, 2004).

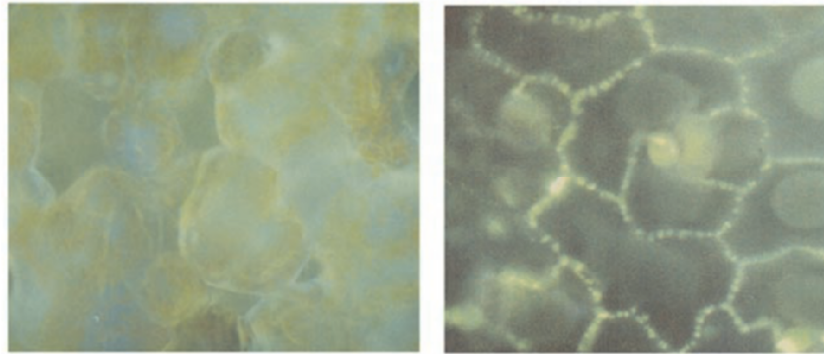

Figure 2. Callose deposition in the leaf epidermis of *Nicotiana glutinosa* is stimulated by SA. Left - untreated leaves, right - leaves treated with 1mM SA 1 hour ago. Callose was determined by its fluorescence after staining with aniline blue.

However, callose deposition around the infection sites is not a universal way of plant defense. At fungal infection, callose can even enhance infection spreading, by providing the fungus with an additional source of nutrition for growth (Jacobs *et al.*, 2003). After the identification of the glucan synthase-like *AtGSL5* gene in *Arabidopsis thaliana*, (Østergaard *et al.*, 2002), the plants with silent callose synthase *GSL5* gene were obtained (Jacobs *et al.*, 2003). Such plants did not contain wound callose and callose producing papillae during infection with powdery mildew and other fungal pathogens. In spite of the absence of callose, plant resistance did not decline; papillae were formed but from other compounds. Similar data were obtained with the arabidopsis *pmr4* mutant, which did not produce callose after infection with powdery mildew; this mutant was even more resistant than wild-type plants. It turned out that the cause for improved resistance in callose-deficient plants was an activation of SA-dependent defense responses (Nishimura *et al.*, 2003). The authors concluded that callose synthesis is, on the one hand, a rapid plant response to stresses but on the other hand also results in the inhibition of other SA-dependent defense responses.

Ca^{2+} can affect plasmodesmatal permeability not only by the activation of callose synthase. Another, a more fine and still more rapid way of the control of callose content in the cells is related to the effects of Ca^{2+} on the cytoskeleton, whose functioning is evidently required for callose deposition. Cytochalasin, an inhibitor of cytoskeleton, disturbed callose deposition, and even nonpathogenic fungi penetrated into the cells and produced haustoria (Kobayashi and Hakuno, 2003).

3.3.2 Effect of salicylic acid on β -1,3-glucanase activity

In addition to callose synthase, the content of callose in the cell is under the control of another enzyme - β -1,3-glucanase. β -1,3-Glucanase catalyzes callose breakdown, including the callose that is located around plasmodesmata. Such an activity of the enzyme must abolish callose-induced plasmodesmata narrowing, thus facilitating their transport activity. On the other hand, β -1,3-glucanase is one of plant defense proteins (PR2). Since PR2 hydrolyzes glycans in the cell walls of many fungal and bacterial species, their role in plant defense against these pathogens is very important (Linthorst, 1991; Lozovaya *et al.*, 1998; Li *et al.*, 2003; Wróbel-Kwiatkowska *et al.*, 2004). β -1,3-Glucanase is shown to exert a direct action on the growth of pathogenic fungi (Mauch *et al.*, 1988; Leubner-Metzger and Meins, 1999). Therefore, an increase in the intracellular content of β -1,3-glucanase is correlated with the improved plant resistance to fungal and bacterial pathogens.

Viral infection induces β -1,3-glucanase as well. The content of glucanase increased 20--30-fold in several days after TMV treatment of necrotic lesions-producing plants (Kauffmann *et al.*, 1987; Vögeli-Lange *et al.*, 1988). The significance of such an increase for virus-infected plants is not quite clear. Activation of β -1,3-glucanase might be an unspecific plant response to stresses, and viruses only passively use a plant response, against fungal infection, thus facilitating their spreading within the host tissues by callose hydrolysis.

β -1,3-Glucanase functioning as plant defense PR-protein starts simultaneously with the appearance of visible injuries, 2--7 days after infection. During the early period, enzyme activity facilitates the infection spreading. *Nicotiana tabacum* and *N. sylvestris* plants deficient in β -1,3-glucanase synthesis (antisense expression or glucanase-deficient mutant) turned out to be more resistant to TMV infection. In these plants, symptoms of viral infection were less expressed, the number and size of lesions decreased, and these lesions appeared later, than in control plants. In mutants, deficient in β -1,3-glucanase activity, a reduced plasmodesmatal permeability (SEL) was noted that could not be controlled by viral movement proteins; the cell-to-cell transport of different viruses was retarded (Beffa *et al.*, 1996; Iglesias and Meins, 2000; Bucher *et al.*, 2001). The reason might be a stronger increase in the callose content near plasmodesmata and around necrotic lesions.

Interdependence occurs between glucanase activity, callose content, and viral moving proteins. Viral movement proteins are capable to increase SEL of plasmodesmata and facilitate viral translocation to neighboring cells. Such plasmodesmatal opening occurs at advancing edge of the infected region;

β -1,3-glucanase activation and callose content decrease in this region (Oparka *et al.*, 1997; Roberts *et al.*, 1998; Bucher *et al.*, 2001). That means that viruses can induce local callose degradation by the induction of β -1,3-glucanase. Plant response might be in the formation of compensatory (ersatz) callose and later the induction of antiviral β -1,3-glucanase. SA might be involved in these processes.

It is well known that SA induces the synthesis of β -1,3-glucanase in various plant species (Shah and Klessig, 1996; Vidal *et al.*, 1997; Kang *et al.*, 1998; Li *et al.*, 2003; Zhen and Li, 2004, and many other reports). The SA-responsive elements in the promoter of the gene, encoding glucanase were identified (Shah and Klessig, 1996; Li *et al.*, 2005). β -1,3-glucanase is activated during HR; its increased activity is often used as an indicator of the involvement of SA-dependent signaling pathway. Such processes demand long-term SA treatment and are manifested only within two or more days.

We could not find any activation of β -1,3-glucanase at the early duration (3-20h) of action of SA in tobacco leaves (Serova *et al.*, 2006). In contrast, enzyme activity decreased. Such enzyme inactivation was correlated with callose accumulation in the leaf tissues and retardation of cell-to-cell TMV transport. By using of transgenic tobacco plants with apoplastic or cytosolic localization of bacterial β -1,3-glucanase it was observed that extracellular β -1,3-glucanase activity resulted in a greater decrease in callose content in tissues than cytosolic enzyme (Serova *et al.*, 2006).

A complex combination of SA-dependent and SA-independent metabolic pathways is known to determine plant resistance to biotic and abiotic stress factors. Such multiplicity of defense responses expands plant possibility to protect themselves against diverse pathogens and unfavorable environmental factors. Among such defense responses, a rapid and reversible synthesis of callose takes an important place; it limits the availability of the plasmodesmal transport route for spreading the infection or that of damaging agents. This type of defense responses may function independently of the pathway leading to the synthesis of PR-proteins; it represents an independent alternative defense mechanism (Zimmerli *et al.*, 2000; Chen *et al.*, 2002).

4. CONCLUSION

It has long been known that changes in the plasma membrane properties of the cell are one of the earliest observed responses to the presence of exogenous SA. However, the exact location for these responses in the system of SA-induced responses has not yet established. The possible reason is a similarity in the changes of membrane properties, induced by diverse factors. This implies that the very first cell response to exogenous SA is

unspecific. A transition of unspecific into specific response to a particular factor is a general biological and so far has been an unsolved problem.

Biotic and abiotic stresses and separate molecules induce potassium efflux and proton and calcium influx into the cell. Depolarization of the plasma membrane may result because of these changes in ion fluxes. SA molecule, being a protonophore, can enhance dissipation of the membrane electric potential. It might be that temporal parameters of these changes at the level of the membrane potential contain some information, but this aspect of SA action is unknown. Another property of SA molecules is its capability of metal chelating that can be manifested at the cell surface. However, the consequences of this putative SA effect on the cell are unknown as well. SA is also capable of converting into the free radical by interacting with apoplastic peroxidase; therefore, it can oxidize other compounds and thus changes the redox state of the apoplast. It seems understandable that ROS effects and SA protective properties are very much alike.

A specific response is determined by the interaction between some stimulus and its receptor at the membrane. However, I am not aware about the occurrence of such receptors of SA. To understand the significance of primary cell responses to SA, a detail study of temporal parameters of changes occurring and their dependence on the concentration of the acting agent is required. The data concerning tissue- and species-specificity to SA action are scarce. In-between, differences in SA effects induced in different plant tissues and species can help in the understanding the role of SA in various processes as well (see an interesting report by Mayers *et al.*, 2005). The detection of particular SA-depended reactions is also of importance. One of the directions of such a search is SA effects on callose synthesis. When our data about the inhibition of β -1,3-glucanase activity by SA treatment will be confirmed, in further experiments, SA-induced callose deposition at the outer plasma membrane surface might turn out to be one of the primary responses to SA, which might be more specific. A rapid and reversible callose deposition at the plasmodesmatal neck regions is an efficient way to affect transport through plasmodesmata, including those of signal molecules and pathogens. A search for other ways of cell-to-cell transport regulation also seems promising.

5. ACKNOWLEDGMENT

I am very grateful to Dr. Nella Klyachko for useful discussion and help in preparing the manuscript. Our studies were supported by the Russian Foundation for Basic Research, project no. 04-04-49426

6. REFERENCES

- Adams, J. M., and Corey, S., 2001. Life-or-death decisions by the Bcl-2 protein family. *Trends Biochem. Sci.*, **26**: 61-66.
- Alvarez, M. E., 2000. Salicylic acid in the machinery of hypersensitive cell death and disease resistance. *Plant Mol. Biol.*, **44**: 429-442.
- Alvarez, M. E., Pennell, R. I., Meijer, P. J., Ishikawa, A., Dixon, R. A., and Lamb, C., 1998. Reactive oxygen intermediates mediate a systemic signal network in the establishment of plant immunity. *Cell*, **92**: 773-784.
- Anderson, M. D., Chen, Z., and Klessig, D. F., 1998. Possible involvement of lipid peroxidation in salicylic acid-mediated induction of PR-1 gene expression. *Phytochem.*, **47**: 555-566.
- Arpagaus, S., Rawlyer, A., and Braendle, R., 2002. Occurrence and characteristics of the mitochondrial permeability transition in plants. *J. Biol. Chem.*, **277**: 1780-1787.
- Assaad, F. F., 2001. Of weeds and men: what genomes teach us about plant cell biology. *Curr. Opin. Plant Biol.*, **4**: 478-487.
- Atkinson, M. M., Huang, J., and Knopp, J. A., 1985. The hypersensitive reaction of tobacco to *Pseudomonas syringae* pv. *pisi* activation of a plasmalemma K^+/H^+ exchange mechanism. *Plant Physiol.*, **79**: 843-847.
- Atkinson, M. A., Keppler, L. D., Orlandi, E. W., Baker, C. J., and Mischke, C. F., 1990. Involvement of plasma membrane calcium influx in bacterial induction of the K^+/H^+ and hypersensitive responses in tobacco. *Plant Physiol.*, **92**: 215-221.
- Bach, M., Schnitzler, J.-P., and Seitz, H. U., 1993. Elicitor-induced changes in Ca^{2+} influx, K^+ efflux, and 4-hydroxybenzoic acid synthesis in protoplasts of *Daucus carota* L. *Plant Physiol.*, **103**: 407-412.
- Badelt, K., White, R. G., Overall, R. L., and Vesik, M., 1994. Ultrastructural specializations of the cell wall sleeve around plasmodesmata. *Am. J. Bot.*, **81**: 1422-1427.
- Bailey, B. A., Dean, J. F. D., and Anderson, J. D., 1990. An ethylene biosynthesis-inducing endoxylanase elicits electrolyte leakage and necrosis in *Nicotiana tabacum* cv Xanthi leaves. *Plant Physiol.*, **94**: 1849-1854.
- Baker, C. J., Atkinson, M. M., and Collmer, A., 1987. Concurrent loss in *Tn5* mutants of *Pseudomonas syringae* pv. *syringae* of the ability to induce the hypersensitive response and host plasma membrane K^+/H^+ exchange in tobacco. *Phytopath.*, **77**: 1268-1272.
- Balasubramanian, S. V., Straubinger, R. M., and Morris, M. E., 1997. Salicylic acid induces changes in the physical properties of model and native kidney membranes. *J. Pharm. Sci.*, **86**: 199-204.
- Balk, J., Leaver, C. J., and McCabe, P. F., 1999. Translocation of cytochrome *c* from the mitochondria to the cytosol occurs during heat-induced programmed cell death in cucumber plants. *FEBS Lett.*, **463**: 151-154.
- Baluška F., Šamaj, J., Napier, R., and Volkmann, D., 1999. Maize calreticulin localizes preferentially to plasmodesmata in root apex. *Plant J.* **19**: 481-488.
- Baluška, F., Cvrckova, F., Kendrick-Jones, J., and Volkmann, D., 2001. Sink plasmodesmata as gateways for phloem unloading. Myosin VIII and calreticulin as molecular determinants of sink strength? *Plant Physiol.*, **126**: 39-46.
- Baluška F., Hlavacka, A., Volkmann, D., and Menzel, D., 2004. Getting connected: actin-based cell-to-cell channels in plants and animals. *Trends Cell Biol.*, **14**: 404-408.
- Basta, D., and Ernst, A., 2004. Effects of salicylate on spontaneous activity in inferior colliculus brain slices. *Neurosci. Res.*, **50**: 237-243.

- Beffa, R. S., Hofer, R.-M., Thomas, M., and Meins, F., Jr., 1996. Decreased susceptibility to viral disease of β -1,3-glucanase-deficient plants generated by antisense transformation. *Plant Cell*, **8**: 1001-1011.
- Bhujra, P., McLachlan, K., Stephens, J., and Taylor, G., 2004. Accumulation of β -1,3-glucans, in response to aluminum and cytosolic calcium in *Triticum aestivum*. *Plant Cell Physiol.*, **45**: 543-549.
- Blackman, L. M., and Overall, R. L., 1998. Immunolocalization of the cytoskeleton to plasmodesmata of *Chara corallina*. *Plant J.*, **14**: 733-741.
- Blackman, L. M., Harper, J. D. I., and Overall, R. L., 1999. Localization of a centrin-like protein to higher plant plasmodesmata. *Eur. J. Cell Biol.*, **78**: 297-304.
- Blatt, M. R., and Grabov, A., 1997. Signaling gates in abscisic acid-mediated control of guard cell ion channels. *Plant Physiol.*, **100**: 481-490.
- Botha, C. E. J., and Cross, R. H. M., 2000. Toward reconciliation of structure with function in plasmodesmata: who is the gatekeeper. *Micron.*, **31**: 713-721.
- Bowler, C., and Fluhr, R., 2000. The role of calcium and activated oxygens as signals for controlling cross-tolerance. *Trends Plant Sci.*, **5**: 241-246.
- Bucher, G. L., Tarina, C., Heinlein, M., Serio, F. D., Meins, F., Jr., and Iglesias, V. A., 2001. Local expression of enzymatically active class I β -1,3-glucanase enhances symptoms of TMV infection in tobacco. *Plant J.*, **28**: 361-369.
- Cai, J., and Jones, D.P., 1998. Superoxide in apoptosis. Mitochondrial generation triggered by cytochrome *c* loss. *J. Biol. Chem.*, **273**: 11401-11404.
- Castagne, V., Barneoud, P., and Clarke, P. G., 1999. Protection of axotomized ganglion cells by salicylic acid. *Brain Res.*, **840**: 162-166.
- Cessna, S. G., and Low, P.S., 2001. Activation of the oxidative burst in aequorin-transformed *Nicotiana tabacum* cells is mediated by protein kinase- and anion channel-dependent release of Ca^{2+} from internal stores. *Planta*, **214**: 126-134.
- Chen, H.-J., Hou, W.-C., Kuc, J., and Lin, Y.-H., 2002. Salicylic acid mediates alternative signal transduction pathways for pathogenesis-related acidic β -1,3-glucanase (protein N) induction in tobacco cell suspension culture. *J. Plant Physiol.*, **159**: 331-337.
- Chen, Z., Silva, H., and Klessig, D. F., 1993. Active oxygen species in the induction of plant systemic acquired resistance by salicylic acid. *Science*, **263**: 1883-1886.
- Chivasa, S., and Carr, J., 1998. Cyanide restores *N*-gene mediated resistance to tobacco mosaic virus in transgenic tobacco expressing salicylic acid hydroxylase. *Plant Cell*, **10**: 1489-1498.
- Chivasa, S., Murphy, A. M., Naylor, M., and Carr, J. P., 1997. Salicylic acid interferes with tobacco mosaic virus replication via a novel salicylhydroxamic acid-sensitive mechanism. *Plant Cell*, **9**: 547-557.
- Chui, C. H., Lau, F. Y., Chan, A. S., Cheng, G. Y., Wong, R. S., Lai, K. B., Kok, S. H., Yeung, T. T., Teo, I. T., Yau, M. Y., Cheung, F., Cheng, C. H., and Tang, J. C., 2005. *Gleditsia sinensis* fruit extract-induced apoptosis involves changes of reactive oxygen species level, mitochondrial membrane depolarization and caspase 3 activation. *Int. J. Mol. Med.*, **15**: 539-543.
- Citovsky, V., McLean, B. G., Zupan, J. R., and Zambryski, P., 1993. Phosphorylation of tobacco mosaic virus cell-to-cell movement protein by a developmentally regulated plant cell wall-associated protein kinase. *Gene Dev.*, **7**: 904-910.
- Clarke, S. E., 1996. Plant cell communication: the world outside the plasma membrane. *Trends Plant Sci.*, **1**: 406-407.
- Clayton, H., Knight, M. R., Knight, H., McAinsh, M. R., and Hetherington, A. M., 1999. Dissection of the ozone-induced calcium signature. *Plant J.*, **17**: 575-579.

- Clough, S. J., Fengler, K. A., Yu, I. C., Lippok, B., Smith, R. K., Jr., and Bent, A. F., 2000. The *Arabidopsis dnd1* "defense no death" gene encodes a mutated cyclic nucleotide-gated ion channel. *Proc. Natl. Acad. Sci. USA.*, **97**: 9323-9328.
- Conrath, U., Chen, Z., Ricigliano, J. R., and Klessig, D. F., 1995. Two inducers of plant defense responses, 2, 6-dichloroisonicotinic acid and salicylic acid, inhibit catalase activity in tobacco. *Proc. Natl. Acad. Sci. USA.*, **92**: 7143-7147.
- Conrath, U., Jeblick, W., and Kauss, H., 1991. The protein inhibitor, K-252a, decreases elicitor induced Ca^{2+} uptake and K^{+} release, and increases coumarin synthesis in parsley cells. *FEBS Lett.*, **279**: 141-144.
- Cook, A. A., and Stall, R. E., 1968. Effect of *Xanthomonas vesicatoria* on loss of electrolytes from leaves *Capsicum annuum*. *Phytopath.*, **58**: 617-619.
- Currier, H., and Webster, D. H., 1964. Callose formation and subsequent disappearance: studies in ultrasound stimulation. *Plant Physiol.*, **39**: 843-847.
- Dat, J. F., Lopez-Dalgado, H., Foyer, C. H., and Scott, I. M., 1998. Parallel changes in H_2O_2 and catalase during thermotolerance induced by salicylic acid or heat acclimation in mustard seedlings. *Plant Physiol.*, **116**: 1351-1357.
- DeRoy, S., Thilmoney, R., Kwack, Y.-B., Nomura, K., and He, S. Y., 2004. A family of conserved bacterial effectors inhibits salicylic acid-mediated basal immunity and promotes disease necrosis in plants. *Proc. Natl. Acad. Sci. USA.*, **101**: 9927-9932.
- Del Pozo, O., and Lam, E., 1998. Caspases and programmed cell death in the hypersensitive response of plants to pathogens. *Curr. Biol.*, **8**: 1129-1132.
- Delaney, T. P., Uknes, S., Vernooij, B., Friedrich, L., Weymann, K., Negroto, D., Gaffney, T., Gut-Rella, M., Kessmann, H., Ward, E., and Ryals, J., 1994. A central role of salicylic acid in plant disease resistance. *Science.*, **266**: 1247-1250.
- Delmer, D. P., Volokita, M., Solomon, M., Fritz, U., Delphendahl, W., and Herth, W., 1993. A monoclonal antibody recognizes a 65 kDa higher plant membrane polypeptide which undergoes cation-dependent association with callose deposition *in vivo*. *Protoplasma*, **176**: 33-42.
- Demidchik, V., Shabala, S. N., Coutts, K. B., Tester, M. A., and Davies, J. M., 2003. Free oxygen radicals regulate plasma membrane Ca^{2+} - and K^{+} -permeable channels in plant root cells. *J. Cell Sci.*, **116**: 81-88.
- Desagher, S., and Martinou, J.-C., 2000. Mitochondria as the central control point of apoptosis. *Trends Cell Biol.*, **10**: 369-377.
- Ding, B., Kwon, M. O., and Warnberg, L., 1996. Evidence that actin filaments are involved in controlling the permeability of plasmodesmata in tobacco mesophyll. *Plant J.*, **10**: 157-164.
- Doares, S.H., Narváez-Vásquez, J., Conoconi, A., and Ryan, C.A., 1995. Salicylic acid inhibits synthesis of proteinase inhibitors in tomato leaves induced by systemin and jasmonic acid. *Plant Physiol.*, **108**: 1741-1746.
- Doherty, H. M., and Bowles, D. J., 1990. The role of pH and ion transport in oligosaccharide-induced proteinase inhibitor accumulation in tomato plants. *Plant Cell Environ.*, **13**: 851-855.
- Donofrio, N. M., and Delaney, T. P., 2001. Abnormal callose response phenotype and hypersusceptibility to *Peronospora parasitica* in defence-compromised *Arabidopsis nim1-1* and salicylate hydroxylase-expressing plants. *Mol. Plant-microbe Interact.*, **14**: 439-450.
- Dumont, A., Hehner, S. P., Hofmann, T. G., Ueffing, M., Droge, W., and Schmitz, M. L., 1999. Hydrogen peroxide-induced apoptosis is CD 95-independent, requires the release of mitochondria-derived reactive oxygen species and the activation of NF-kappaB. *Oncogene*, **18**: 747-757.

- Durner, J., and Klessig, D. F., 1996. Salicylic acid is a modulator of tobacco and mammalian catalases. *J. Biol. Chem.*, **271**: 28492-28501.
- Ehlers, K., and Kollmann, R., 2001. Primary and secondary plasmodesmata: structure, origin and functioning. *Protoplasma*, **216**: 1-30.
- Engelberth, J., Koch, T., Schöler, G., Bachmann, N., Rechtenbach, Y., and Boland, W., 2001. Ion channel-forming alamethicin is a potent elicitor of volatile biosynthesis and tendrill coiling. Cross talk between jasmonate and salicylate signaling in lima bean. *Plant Physiol.*, **125**: 369-377.
- Enkerli, K., Hahn, M. G., and Mims, C. W., 1997. Immunogold localization of callose and other plant cell wall components in soybean roots infected with oomycete *Phytophthora sojae*. *Can. J. Bot.*, **75**: 1509-1517.
- Enyedi, A. J., Yalpani, N., Silverman, P., and Raskin, I., 1992. Localization, conjugation, and function of salicylic acid in tobacco during the hypersensitive reaction to tobacco mosaic virus. *Proc. Natl. Acad. Sci. USA.*, **89**: 2480-2484.
- Eschrich, W., 1965. Physiologie der Siebröhrencallose. *Planta*, **65**: 280-300.
- Felix, G., and Boller, T., 1995. Systemin induces rapid ion fluxes and ethylene biosynthesis in *Lycopersicon peruvianum* cells. *Plant J.*, **7**: 381-389.
- Foreman, J., Demidchik, V., Bothwell, J. H. F., Mylona, P., Miedema, H., Torres, M. A., Linstead, P., Costa, S., Brownlee, C., Jones, J.D.G., Davies, J., and Dolan, L., 2003. Reactive oxygen species produced by NADPH oxidase regulate plant cell growth. *Nature*, **422**: 442-446.
- Forte, M., and Bernardi, P., 2005. Genetic dissection of the permeability transition pore. *J. Bioenerg. Biomembr.*, **37**: 121-128.
- Gaffney, T., Friedrich, L., Vernooij, B., Negrotto, D., Nye, G., Uknes, S., Ward, E., Kessmann, H., and Ryals, J., 1993. Requirement of salicylic acid for the induction of systemic acquired resistance. *Science*, **261**: 754-756.
- Garcia-Sancho, J., and Sanchez, A., 1978. Use of salicylic acid to measure the apparent intracellular pH in the Ehrlich ascites-tumor cell and *Escherichia coli*. *Biochem. Biophys. Acta*, **509**: 148-158.
- Gilliland, A., Singh, D. P., Hayward, J. M., Moore, C. A., Murphy, A. M., York, C. J., Slatore, J., and Carr, J. P., 2003. Genetic modification of alternative respiration has differential effects on antimycin A-induced versus salicylic acid-induced resistance to tobacco mosaic virus. *Plant Physiol.*, **132**: 1518-1528.
- Glass, A. D. M., 1973. Influence of phenolic acids on ion uptake. I Inhibition of phosphate uptake. *Plant Physiol.*, **51**: 1037-1041.
- Glass, A. D. M., 1974a. Influence of phenolic acids upon ion uptake. III Inhibition of potassium absorption. *J. Exp. Bot.*, **25**: 1104-1113.
- Glass, A. D. M., 1974b. Influence of phenolic acids on ion uptake. IV Depolarization of membrane potentials. *Plant Physiol.*, **54**: 855-858.
- Glass, A. D. M., 1975. Inhibition of phosphate uptake in barley roots by hydroxybenzoic acids. *Phytochem.*, **14**: 2127-2130.
- Goodman, R. N., 1968. The hypersensitive reaction in tobacco: a reflection of changes in host cell permeability. *Phytopath.*, **58**: 872-875.
- Goodman, R. N., and Plurad, S.B., 1971. Ultrastructural changes in tobacco undergoing the hypersensitive reaction caused by plant pathogenic bacteria. *Physiol. Plant Pathol.*, **1**: 11-16.
- Gordon, L. Kh, Minibayeva, F. V., Ogorodnikova, T. I., Rachmatullina, D. F., Tzentzevitzky, A. N., Koselnikov, O. P., Maksyutin, D. A., and Valitova, J. N., 2002. Salicylic acid induces dissipation of the proton gradient on the plant cell plasma membrane. *Dokl. Biol. Sci.*, **387**: 581-583 (in Russian).

- Green, D. R., and Reed, J. C., 1998. Mitochondria and apoptosis. *Science*, **281**: 1309-1312.
- Guern, J., Mathieu Y., Thomine, S., Jouanneau, J. P., and Beloeil, J. C., 1992. Plant cells counteract cytoplasmic pH changes but likely use these pH changes as secondary messages in signal perception. *Curr Top Plant Biochem. Physiol.*, **11**: 249-269.
- Hahlbrock, K., and Scheel, D., 1989. Physiology and molecular biology of phenylpropanoid metabolism. *Annu. Rev. Plant Physiol. Plant Mol. Biol.*, **40**: 347-369.
- Hahlbrock, K., Scheel, D., Logeman, E., Nürnberger, T., Parniske, M., and Reinhold, S., 1995. Oligopeptide elicitor-mediated defense gene activation in cultured parsley cells. *Proc Natl. Acad. Sci. USA*, **92**: 4150-4157.
- Harper, J. R., and Balke, N. E., 1981. Characterization of the inhibition of K⁺ absorption in oat roots by salicylic acid. *Plant Physiol.*, **68**: 1349-1353.
- He, D. Y., Yazaki, Y., Nishizawa, Y., Takai, R., Yamada, K., Sakano, K., Shibuya, N., and Minami, E., 1998. Gene activation by cytoplasmic acidification in suspension-cultured rice cell in response to the potent elicitor, N-acetylchitoheptaose. *Mol. Plant-Microbe Interact.*, **11**: 1167-1174.
- Hedrich, R., and Schroeder, J. I., 1989. The physiology of ion channels and electrogenic pumps in higher plants. *Annu. Rev. Plant Physiol. Plant Mol. Biol.*, **40**: 539-569.
- Hennig, J., Malamy, J., Gryniewicz, G., Indulski, J., and Klessig, D. F., 1993. Interconversion of the salicylic acid signal and its glucoside in tobacco. *Plant. J.*, **4**: 593-600.
- Hofius, D., Hajirezaei, M. R., Geiger, M., Tschiersch, H., Melzer, M., and Sonnwald, U., 2004. RNA_i-mediated tocopherol deficiency impairs photoassimilate export in transgenic potato plants. *Plant Physiol.*, **135**: 1256-1268.
- Holdaway-Clarke, T. L., Walker, N. A., Hepler, P. K., and Overall, R. L., 2000. Physiological elevations in cytoplasmic free calcium by cold or ion injection result in transient closure of higher plant plasmodesmata. *Planta*, **210**: 329-335.
- Horn, M. A., Meadows, R. P., Apostol, I., Jones, C. R., Gorenstein, D.G., Heinstejn, P. F., and Low, P.S., 1992. Effect of elicitation and changes in extracellular pH on the cytoplasmic and vacuolar pH of suspension-cultured soybean cells. *Plant Physiol.*, **98**: 680-686.
- Iglesias, V. A., and Meins, F., Jr., 2000. Movement of plant viruses is delayed in a β -1,3-glucanase-deficient mutant showing a reduced plasmodesmatal size exclusion limit and enhanced callose deposition. *Plant J.*, **21**: 157-166.
- Jabs, T., 1999. Reactive oxygen intermediates as mediators of programmed cell death in plants and animals. *Biochem. Pharmacol.*, **57**: 231-245.
- Jabs, T., Tschöpe, M., Colling, C., Hahlbrock, K., and Scheel, D., 1997. Elicitor-stimulated ion fluxes and O² from the oxidative burst are essential components in triggering defense gene activation and phytoalexin synthesis in parsley cells. *Proc. Natl. Acad. Sci. USA*, **92**: 4150-4157.
- Jacobs, A. K., Lipka, V., Burton, R. A., Panstruga, R., Strizhov, N., Schulze-Lefert, P., and Fincher, G. B., 2003. An Arabidopsis callose synthase, GSL 5, is required for wound and papillary callose formation. *Plant Cell*, **15**: 2503-2513.
- Jay, D., Jay, E. G., and Medina, M. A., 1999. Superoxide dismutase activity of the salicylate-iron complex. *Arch. Med Res.*, **30**: 93-96.
- Jones, A., 2000. Does the plant mitochondrion integrate cellular stress and regulate programmed cell death? *Trends Plant Sci.*, **5**: 225-230.
- Kang, M. K., Park, K. S., and Choi, D., 1998. Coordinated expression of defense-related genes by TMV infection or salicylic acid treatment in tobacco. *Mol. Cells*, **31**: 388-392.
- Kartusch, R., 2003. On the mechanism of callose synthesis induction by metal ions in onion epidermal cells. *Protoplasma*, **220**: 219-225.

- Katz, V. A., Thulke, O. U., and Conrath, U., 1998. A benzothiadiazole primes parsley cells for augmented elicitation of defense responses. *Plant Physiol.*, **117**: 1333-1339.
- Katz, V., Fuchs, A., and Conrath, U., 2002. Pretreatment with salicylic acid primes parsley cells for enhanced ion transport following elicitation. *FEBS Lett.*, **520**: 53-57.
- Kauffmann, S., Legrand, M., Geoffroy, P., and Fritig, B., 1987. Biological function of "pathogenesis-related" proteins: four PR proteins of tobacco have β -1,3-glucanase activity. *EMBO J.*, **6**: 3209-3212.
- Kauss, H., 1985. Callose biosynthesis as a Ca^{2+} -regulated process and possible relations to the induction of other metabolic changes. *J. Cell Sci.*, Suppl. **2**: 89-103.
- Kauss, H., 1987. Callose-Synthese: Regulation durch Induzierten Ca^{2+} -Einstrom in Pflanzenzellen. *Naturwissenschaften.*, **74**: 275-281.
- Kauss, H., and Jeblick, W., 1985. Activation by polyamines, polycations, and ruthenium red of the Ca^{2+} -dependent glucan synthase from soybean cells. *FEBS Lett.*, **185**: 226-230.
- Kauss, H., and Jeblick, W., 1986. Influence of free fatty acids, lysophosphatidylcholine, platelet-activating factor, acylcarnitine, and echinocandin B on 1,3- β -D-glucan synthase and callose synthesis. *Plant Physiol.*, **80**: 7-13.
- Kauss, H., and Jeblick, W., 1986. Synergistic activation of 1,3- β -D-glucan synthase by Ca^{2+} and polyamines. *Plant Sci. Lett.*, **43**: 103-107.
- Kauss, H., and Jeblick, W., 1995. Pretreatment of parsley suspension cultures with salicylic acid enhances spontaneous and elicited production of H_2O_2 . *Plant Physiol.*, **108**: 1171-1178.
- Kauss, H., Theisinger-Hinkel, E., Mindermann, R., and Conrath, U., 1992. Dichloroisonicotinic and salicylic acid, inducers of systemic acquired resistance, enhance fungal elicitor responses in parsley cells. *Plant J.*, **2**: 655-660.
- Kawano, T., and Muto, S., 2000. Mechanism of peroxidase actions for salicylic acid-induced generation of active oxygen species and an increase in cytosolic calcium in tobacco cell suspension culture. *J. Exp. Bot.*, **51**: 685-693.
- Kawano, T., Sahashi, N., Takahashi, K., Uozumi, N., and Muto, S., 1998. Salicylic acid induces extracellular generation of superoxide followed by an increase in cytosolic calcium ion in tobacco suspension culture: the earliest events in salicylic acid signal transduction. *Plant Cell Physiol.*, **39**: 721-730.
- Keppeler, L.D., and Baker, C.J., 1989. O_2^- -initiated lipid peroxidation in a bacteria-induced hypersensitive reaction in tobacco cell suspensions. *Phytopath.*, **79**: 555-562.
- Keppeler, L.D., and Novacky, A., 1986. Involvement of membrane lipid peroxidation in the development of a bacterially induced hypersensitive reaction. *Phytopath.*, **76**: 104-107.
- Kim, J-S., He, L., and Lemasters, J. J., 2003. Mitochondrial permeability transition: a common pathway to necrosis and apoptosis. *Biochem. Biophys. Res. Commun.*, **304**: 463-470.
- Klessig, D. F., and Malamy, J., 1994. The salicylic acid signal in plants. *Plant Mol. Biol.*, **26**: 1439-1458.
- Kneusel, R. E., Matern, U., and Nicolay, K., 1989. Formation of *trans*-caffeoyl-CoA from *trans*-coumaroyl-CoA by Zn^{2+} -dependent enzymes in cultured plant cells and its activation by an elicitor-induced pH shift. *Arch. Biochem. Biophys.*, **269**: 455-462.
- Kobayashi, I., and Hakuno, H., 2003. Actin-related defense mechanism to reject penetration attempt by a non-pathogen is maintained in tobacco BY-2 cells. *Planta*, **217**: 340-345.
- Köhle, H., Jeblick, W., Poten, F., Blaschek, W., and Kauss, H., 1985. Chitosan-elicited callose synthesis in soybean cells as a Ca^{2+} -dependent process. *Plant Physiol.*, **77**: 544-551.

- Korthout, H. A. A. J., Berecki, G., Bruin, W., van Duijn, B., and Wang, M., 2000. The presence and subcellular localization of caspase 3-like proteinases in plant cells. *FEBS Lett.*, **475**: 139-144.
- Koumura T., Nakamura, C., and Nakagawa, T., 2005. Involvement of hydroperoxide in mitochondria in the induction of apoptosis by the eicosapentaenoic acid. *Free Radic. Res.*, **39**: 225-235.
- Krasavina, M. S., Kulikova, A. L., Ktitorova, I. N., and Burmistrova, N. A., 1998. A possible role of actin in regulating conductance of plasmodesmata. *Proc. Biol. Sci.*, **362**: 464-466.
- Krasavina, M. S., Ktitorova, I. N., and Burmistrova, N. A., 2001. Electrical conductance of cell-to-cell junctions and cytoskeleton of plant cells. *Russian J. Plant Physiol.*, **48**: 741-748.
- Krasavina, M. S., Malysenko, S. I., Raldugina, G. N., Burmistrova, N. A., Nosov, A. V., 2002. Can salicylic acid affect the intercellular transport of the tobacco mosaic virus by changing plasmodesmal permeability? *Russian J. Plant Physiol.*, **49**: 61-67.
- Ktitorova, I. N., Skobeleva, O. V., Kanash, E. V., Bilova, T. E., and Sharova, E. P., 2006. The reasons of root growth decrease after UV-B irradiation of barley seedlings. *Russian J. Plant Physiol.* (in press).
- Kuchitsu, K., Yazaki, Y., Sakano, K., and Shibuya, N., 1997. Transient cytoplasmic pH changes and ion fluxes through the plasma membrane in suspension-cultured rice cells triggered by N-acetylchitoooligosaccharide elicitor. *Plant Cell Physiol.*, **38**: 1012-1018.
- Kurkdjian A., and Guern, J., 1989. Intracellular pH: measurement and importance in cell activity. *Annu. Rev. Plant Physiol. Plant Mol. Biol.*, **40**: 271-303.
- Kurosaki, F., Tsurusawa, Y., and Nishi, A., 1987. The elicitation of phytoalexins by Ca²⁺ and cyclic AMP in carrot cells. *Phytochem.*, **26**: 1919-1923.
- Lacomme, C., and Santa Cruz, S., 1999. Bax-induced cell death in tobacco is similar to the hypersensitive response. *Proc. Natl. Acad. Sci. USA.*, **96**: 7956-7961.
- Lapikova, V. P., Gaivoronskaya, L. M., and Aver'yanov, A. A., 2000. Possible involvement of oxygen species in the double induction of plant defense responses. *Russian J. Plant Physiol.*, **47**: 145-147.
- Lapous, D., Mathieu, Y., Guern, J., and Laurière, C., 1998. Increase of defense gene transcripts by cytoplasmic acidification in tobacco cell suspensions. *Planta*, **205**: 452-458.
- Lebrun-Garcia, A., Chiltz, A., Gout, E., Bligny, R., and Pugin, A., 2002. Questioning the role of salicylic acid and cytosolic acidification in mitogen-activated protein kinase activation induced by cryptogin in tobacco cells. *Planta*, **214**: 792-797.
- Lee, S. H., Singh, A. P., and Chung G. C., 2004. Rapid accumulation of hydrogen peroxide in cucumber roots due to exposure to low temperature appears to mediate decreases in water transport. *J. Exp. Bot.*, **55**: 1733-1741.
- Leisner, S. M., and Turgeon, R., 1993. Movement of virus and photoassimilate in the phloem: a comparative analysis. *Bioessays*, **15**: 741-748.
- León, J., Lawton, M. A., and Raskin, I., 1995. Hydrogen peroxide stimulates salicylic acid biosynthesis in tobacco. *Plant Physiol.*, **108**: 1673-1678.
- Leubner-Metzger, G., and Meins, F., Jr., 1999. Function and regulation of plant β -1,3-glucanases (PR-2). In: Datta S. K., Muthukrishnan S., eds., *Pathogenesis related proteins in plants*. USA: CRC Press, 49-76.
- Levine, A., Tenhaken, R., Dixon, R. A., and Lamb, C., 1994. H₂O₂ from oxidative burst orchestrates the plant hypersensitive disease resistance response. *Cell*, **79**: 583-593.
- Levitan, H., and Barker, J.L., 1972. Salicylate: a structure-activity study of its effects on membrane permeability. *Science*, **176**: 1423-1425.

- Li, K., Li, Y., Shelton, J. M., Richardson, J. A., Spencer, E., Chen, Z. J., Wang, X., and Williams, R. S., 2000. Cytochrome *c* deficiency causes embryonic lethality and attenuates stress-induced apoptosis. *Cell*, **101**: 389-399.
- Li, P., Nijhawan, D., Budihardjo, I., Srinivasula, S. M., Ahmad, M., Alnemri, E.S., and Wang, X., 1997. Cytochrome *c* and dATP-dependent formation of Apaf-1/caspase-9 complex initiates an apoptotic protease cascade. *Cell*, **91**: 479-489.
- Li, Y.-F., Zhu, R., and Xu, P., 2005. Activation of the gene promoter of barley β -1,3-glucanase isoenzyme G III is salicylic acid (SA)-dependent in transgenic rice plants. *J. Plant Res.*, **118**: 215-221.
- Li, Y.-Z., Zhen, X.-H., Tang, H.-L., Zhu, J.-W., and Yang, J.-M., 2003. Increase of β -1,3-glucanase and chitinase activities in cotton callus cells treated by salicylic acid and toxin of *Verticillium dahliae*. *Acta Bot. Sin.*, **45**: 802-808.
- Lin, C., Yu, Y., Kadono, T., Iwata, M., Umemura, K., Furuichi, T., Kuse, M., Isobe, M., Yamamoto, Y., Matsumoto, H., Yoshizuka, K., and Kawano, T., 2005. Action of aluminum, novel TPC1-type channel inhibitor, against salicylate-induced and cold-shock-induced calcium influx in tobacco BY-2 cells. *Biochem. Biophys. Res. Commun.*, **332**: 823-830.
- Linthorst, H. J. M., 1991. Pathogenesis-related proteins of plants. *Crit. Rev. Plant Sci.*, **10**: 123-150.
- Liu, X., Kim, C. N., Yang, J., Jemmerson, R., and Wang, X., 1996. Induction of apoptotic program in cell-free extracts: requirement for ATP and cytochrome *c*. *Cell*, **86**: 147-157.
- Liu, Y., and Li, X., 2004. Effects of salicylate on transient outward and delayed rectifier potassium channels in rat inferior colliculus neurons. *Neurosci. Lett.*, **369**: 115-120.
- Lozovaya, V. V., Waranyuwat, A., and Widholmj, M., 1998. β -1,3-glucanase and resistance to *Aspergillus flavus* infection in maize. *Crop Sci.*, **38**: 1255-1260.
- Lucas, W. J., and Lee, J.-Y., 2004. Plasmodesmata as a supracellular control network in plants. *Nat. Rev. Mol. Cell Biol.*, **5**: 712-726.
- Lurin, C., Geelen, D., Barbier-Brygoo, H., Guern, J., and Maurel, C., 1996. Cloning and functional expression of a plant voltage-dependent chloride channel. *Plant Cell*, **8**: 701-711.
- Lyalin, O.O., Akhmedov, I.S., Mamedov, T.A., Borovkov, A.V., Akhmedov, N.I., and Aliev D.A., 1980. Effect of some phytotoxins on membrane potential and electrical resistance of root hair plasma membranes in *Trianea bogotensis* Karst. *Fiziologia Rastenij.*, **27**: 1237-1241 (in Russian).
- Lyalin, O.O., Ktitorova, I.N., Barmicheva, E.M., and Akhmedov, N.I., 1986. Intercellular connections in submersed trichomes of *Salvinia*. *Fiziologia Rastenij.*, **33**: 432-446 (in Russian).
- Macri, F., Vianello, A., and Pennazio, S., 1986. Salicylate-collapsed membrane potential in pea stem mitochondria. *Physiol. Plant.*, **67**: 136-140.
- MacRobbie, E. A. C., 1999. Signal transduction and ion channels in guard cells. *Phil. Trans. Roy. Soc. Lond. B.*, **353**: 1475-1488.
- Malamy, J., Carr, J. P., Klessig, D. F., and Raskin, I., 1990. Salicylic acid: a likely endogenous signal in the resistance response of tobacco to viral infection. *Science*, **250**: 1002-1004.
- Mamulashvily, G. G., Krasavina, M. S., and Lyalin, O. O., 1973. Role of different stem tissues in transduction of action potential. *Fiziol. Rast.*, **20**: 442-450 (in Russian).
- Marre, M. T., Romani, G., and Marre, E., 1983. Transmembrane hyperpolarization and increase of K⁺ uptake in maize roots treated with permeant weak acids. *Plant Cell Environ.*, **6**: 617-623.

- Marzo, I., Brenner, C., Zamzami, N., Susin, S. A., Bentner, G., Brdiczka, D., Rémy, R., Xie Z.-H., Reed, J. C., and Kroemer, G., 1998. Permeability transition pore complex: a target for apoptosis regulation by caspases and Bcl-2-related proteins. *J. Exp. Med.*, **187**: 1261-1271.
- Mathieu, Y., Lapous, D., Thomine, S., Laurière, C., and Guern, J., 1996. Cytoplasmic acidification as an early phosphorylation-dependent response of tobacco cells to elicitors. *Planta*, **199**: 416-424.
- Matsushita, Y., Hanazawa, K., Yoshioka, K., Oguchi, T., Kawakami, S., Watanabe, Y., Nishiguchi, M., and Nyunoya, H., 2000. *In vitro* phosphorylation of the movement protein of tomato mosaic tobamovirus by a cellular kinase. *J. Gen. Virol.*, **81**: 2095-2102.
- Matsushita, Y., Yoshioka, K., Shigyo, T., Takahashi, H., and Nyunoya, H., 2002. Phosphorylation of the movement protein of *Cucumber mosaic virus* in transgenic tobacco plants. *Virus Genes*, **24**: 231-234.
- Mauch, F., Mauch-Mani, B., and Boller, T., 1988. Antifungal hydrolases in pea tissue. II. Inhibition of fungal growth by combinations of chitinase and β -1,3-glucanase. *Plant Physiol.*, **88**: 936-942.
- Maxwell, D. P., Nickels, R., and McIntosh, L., 2002. Evidence of mitochondrial involvement in the transduction of signals required for the induction of genes associated with pathogen attack and senescence. *Plant J.*, **29**: 269-279.
- Mayers, C. N., Lee, K. C., Moore, C. A., Wong, C. A., and Carr, J. P., 2005. Salicylic acid-induced resistance to *Cucumber mosaic virus* in squash and *Arabidopsis thaliana*: contrasting mechanisms of induction and antiviral action. *Mol. Plant Microbe Interact.*, **18**: 428-434.
- McNairn, R. B., 1972. Phloem translocation and heat-induced callose formation in field grown *Gossypium hirsutum* L. *Plant Physiol.*, **50**: 366-370.
- Messiaen, Y., and van Cutsem, 1994. Pectic signal transduction in carrot cells: membrane, cytosolic and nuclear responses induced by oligogalacturonides. *Plant Cell Physiol.*, **35**: 677-689.
- Métraux, J. P., Signer, H., Ryals, J., Ward, E., Wyss-Benz, M., Gaudin, J., Raschdorf, K., Schmid, E., Blum, W., and Inverardi, B., 1990. Increase in salicylic acid at the onset of systemic acquired resistance in cucumber. *Science*, **250**: 1004-1006.
- Michelet, B., and Boutry, M., 1995. The plasma membrane H^+ ATPase. A highly regulated enzyme with multiple physiological functions. *Plant Physiol.*, **108**: 1-6.
- Mittler, R., Shulaev, V., and Lam, E., 1995. Coordinated activation of programmed cell death and defense mechanisms in transgenic tobacco plants expressing a bacterial proton pump. *Plant Cell*, **7**: 29-42.
- Mootha, V. K., Wei, M. C., Buttle, K. F., Scorrano, L., Panoutsakopoulou, V., Mannella, C. A., and Korsmeyer, S. J., 2001. A reversible component of mitochondrial respiratory dysfunction in apoptosis can be rescued by exogenous cytochrome *c*. *EMBO J.*, **20**: 661-671.
- Mori, I. C., Iida, H., Tsuji, F. I., Isobe, M., Uozumi, N., and Muto, S., 1998. Salicylic acid induces a cytosolic Ca^{2+} -elevation in yeast. *Biosci. Biotech. Biochem.*, **62**: 986-989.
- Moyen, C., and Johannes, E., 1996. Systemic transiently depolarises the tomato mesophyll cell membrane and antagonizes fusicoccin-induced extracellular acidification of mesophyll tissue. *Plant Cell Environ.*, **19**: 464-470.
- Mur, L. A., Bi, Y. M., Darby, R. M., Firek, S., and Draper, J., 1997. Compromising early salicylic acid accumulation delays the hypersensitive response and increases viral dispersal during lesion establishment in TMV-infected tobacco. *Plant J.*, **12**: 1113-1126.

- Mur, L. A. J., Naylor, G., Warner, S. A. J., Sugars, J. M., White, R. F., and Draper, J., 1996. Salicylic acid potentiates defense gene expression in tissue exhibiting acquired resistance to pathogen attack. *Plant J.*, **9**: 559-571.
- Murata, Y., Pei, Z. M., Mori, I., C., and Schroeder, J. I., 2001. Abscisic acid activation of plasma membrane Ca^{2+} channels in guard cells requires NAD(P)H and is differentially disrupted upstream and downstream of reactive oxygen species production in the *abi1-1* and *abi2-1* protein phosphatase 2c mutants. *Plant Cell*, **13**: 2513-2523.
- Murphy, A. M., and Carr, J. P., 2002. Salicylic acid has cell-specific effects on *Tobacco mosaic virus* replication and cell-to-cell movement. *Plant Physiol.*, **128**: 552-563.
- Murphy A. M., Chivasa, S., Singh, D. P., and Carr, J.P., 1999. Salicylic acid-induced resistance to viruses and other pathogens: a parting or the ways? *Trends Plant Sci.*, **4**: 155-160.
- Naylor, M., Murphy, A. M., Berry, J. O., and Carr, J. P., 1998. Salicylic acid can induce resistance to plant virus movement. *Mol. Plant-Microbe Interact.*, **1**: 860-868.
- Neill, S., Desikan, R., and Hancock, J., 2002. Hydrogen peroxide signalling. *Curr. Opin. Plant Biol.*, **5**: 388-395.
- Nishimura, M. T., Stein, M., Hou, B.-H., Vogel, J. P., Edwards, H., and Somerville, S. C., 2003. Loss of a callose synthase results in salicylic acid-dependent disease resistance. *Science*, **301**: 969-972.
- Norman, C., Howell, K. A., Millar, A. H., Whelan, A. H., and Day, D. A., 2004. Salicylic acid is an uncoupler and inhibitor of mitochondrial electron transport. *Plant Physiol.*, **134**: 492-501.
- Northcote, D. H., Davey, R., and Lay, J., 1989. Use of antisera to localize callose, xylan, and arabinogalactan in the cell-plate, primary and secondary walls of plant cells. *Planta*, **178**: 353-366.
- Nürnbergger, T., Nennstiel, D., Jabs, T., Sacks, W. R., Hahlbrock, K., and Scheel, D., 1994. High affinity binding of a fungal oligopeptide elicitor to parsley plasma membranes triggers multiple defense responses. *Cell*, **78**: 449-460.
- O'Brien, I. E. W., Baguley, B. C., Murray, B. G., Morris, B. A. M., and Ferguson, I. B., 1998. Early stages of the apoptotic pathway in plant cells are reversible. *Plant J.*, **13**: 803-814.
- Ojalvo, I., Rokem, J. S., Navon, G., and Goldberg, I., 1987. ^{31}P NMR study of elicitor treated *Phaseolus vulgaris* cell suspension cultures. *Plant Physiol.*, **85**: 716-719.
- Olesen, P., and Robards, A. W., 1990. The neck region of plasmodesmata. In: Robards, A. W., Lucas, W. J., Pitts, J. D., Jongsma, H. J., Soray, D. C., eds., *Parallels in cell to cell junctions in plant and animal*. Germany: Springer Verlag, 145-170.
- Oparka, K. J., 2004. Getting the message across: how do plant cells exchange macromolecular complexes. *Trends Plant Sci.*, **9**: 33-40.
- Oparka, K. J., Prior, D. A. M., Santa Crus, S., Padgett, H., and Beachy, R. N., 1997. Gating of epidermal plasmodesmata is restricted to the leading edge of expanding infection sites of tobacco mosaic virus (TMV). *Plant J.*, **12**: 781-789.
- Opritov, V. A., Pyatygin, S. S., and Vodeneev, V. A., 2002. Direct coupling of action potential generation in cells of higher plant (*Cucurbita pepo*) with the operation of an electrogenic pump. *Russian J. Plant Physiol.*, **49**: 142-147.
- Østergaard, L., Petersen, M., Mattsson, O., and Mundy, J., 2002. An *Arabidopsis* callose synthase. *Plant Mol. Biol.*, **49**: 559-566.
- Pavlovkin, J., Novacky, A., and Ulrich-Eberius, C. I., 1986. Membrane potential changes during bacteria induced hypersensitive reaction. *Physiol. Plant Pathol.*, **28**: 125-135.
- Pei, Z. M., Murata, Y., Benning, G., Thomine, S., Klusener, B., Allen, G. J., Grill, E., and Schroeder, J. L., 2000. Calcium channels activated by hydrogen peroxide mediate abscisic acid signaling in guard cells. *Nature*, **406**: 731-734.

- Pelissier, B., Thibaud, J. B., Grignon, C., and Esquerre-Tugaye, M. T., 1986. Cell surfaces in plant microorganism interactions. VII. Elicitor preparations from two fungal pathogens depolarize plant membranes. *Plant Sci.*, **46**: 103-109.
- Petersen, M., Brodersen, P., Naested, H., Andreasson, E., Lindhart, U., Johansen, B., Nielsen, H. B., Lacy, M., Austin, M. J., Parker, J. E., Sharma, S. B., Klessig, D. F., Martienssen, R., Mattsson, O., Jensen, A. B., and Mundy, J., 2000. *Arabidopsis* map kinase 4 negatively regulates systemic acquired resistance. *Cell*, **103**: 1111-1120.
- Pike, S. M., Zhang, X. C., and Gassmann, W., 2005. Electrophysiological characterization of the *Arabidopsis avrRpt 2*-specific hypersensitive response in the absence of other bacterial signals. *Plant Physiol.*, **138**: 1009-1017.
- Prasad, T. K., Anderson, M. D., Martin, B. A., and Steward, C. R., 1994. Evidence for chilling-induced oxidative stress in maize seedlings and a regulatory role for hydrogen peroxide. *Plant Cell*, **6**: 65-74.
- Price, A. H., Taylor, A., Ripley, S. J., Griffiths, A., Trewavas, A. J., and Knight, M. R., 1994. Oxidative signals in tobacco increase cytosolic calcium. *Plant Cell*, **6**: 1301-1310.
- Prithiviraj, B., Bais, H. P., Weir, T., Suresh, B., Najarro, E. H., Dayakar, B. V., Schweizer, H. P., and Vivanco, J. M., 2005. Down regulation of virulence factors of *Pseudomonas aeruginosa* by salicylic acid attenuates its virulence on *Arabidopsis thaliana* and *Caenorhabditis elegans*. *Infect Immun.*, **73**: 5319-5328.
- Pugin, A., Frachisse, J. M., Tavernier, E., Bligny, R., Gout, E., Douce, R., and Guern, J., 1997. Early events induced by the elicitor cryptogein in tobacco cells: involvement of a plasma membrane NADPH oxidase and activation of glycolysis and pentose phosphate pathway. *Plant Cell*, **9**: 2077-2091.
- Radford, J. E., and White, R. G., 1998. Localization of a myosin-like protein to plasmodesmata. *Plant J.*, **14**: 743-750.
- Radford, J. E., Vesik, M., and Overall, R. L., 1998. Callose deposition at plasmodesmata. *Protoplasma*, **201**: 30-37.
- Rao, M. V., Paliyath, G., Ormrod, D. P., Murr, D. P., and Watkins, C. B., 1997. Influence of salicylic acid on H₂O₂ production, oxidative stress, and H₂O₂-metabolizing enzymes. *Plant Physiol.*, **115**: 137-149.
- Raskin, I., 1992. Role of salicylic acid in plants. *Annu. Rev. Plant Physiol. Plant Mol. Biol.* **43**: 439-463.
- Rasmussen, J. B., Hammerschmidt, R., and Zook, M. N., 1991. Systemic induction of salicylic acid accumulation in cucumber after inoculation with *Pseudomonas syringae* pv. *syringae*. *Plant Physiol.*, **97**: 1324-1347.
- Raz, V., Fluhr, R., 1992. Calcium requirement for ethylene-dependent responses. *Plant Cell*, **4**: 1123-1130.
- Reichelt, S., Knight, A. E., Hodge, T. P., Baluška, F., Šamaj, J., Volkmann, D., and Kendrick-Jonas, J., 1999. Characterization of the unconventional myosin VIII in plant cells and its localization at the post-cytokinetic cell wall. *Plant J.*, **19**: 555-569.
- Rentel, M. C., and Knight, M. R., 2004. Oxidative stress-induced calcium signaling in *Arabidopsis*. *Plant Physiol.*, **135**: 1471-1479.
- Rhoads, D. M., and McIntosh, L., 1992. Salicylic acid regulation of respiration in higher plants: alternative oxidase expression. *Plant Cell*, **4**: 1131-1139.
- Rhoads, D. M., and McIntosh, L., 1993. Cytochrome and alternative pathway respiration in tobacco. Effects of salicylic acid. *Plant Physiol.*, **103**: 877-883.
- Roberts, A. G., and Oparka, K. J., 2003. Plasmodesmata and the control of symplasmic transport. *Plant Cell Environ.*, **26**: 103-124.

- Roberts, I. M., Wang, D., Findlay, K., and Maule, A. J., 1998. Ultrastructural and temporal observations of the potyvirus cylindrical inclusions (CIs) show that the CI protein acts transiently in aiding virus movement. *Virology*, **245**: 173-181.
- Roberts, M.R., and Bowles, D.J., 1999. Fusicoccin, 14-3-3 proteins, and defense responses in tomato plants. *Plant Physiol.*, **119**: 1243-1250.
- Robson, C. A., and Vanlerberghe, G. C., 2002. Transgenic plant cells lacking mitochondrial alternative oxidase have increased susceptibility to mitochondria-dependent and – independent pathways of programmed cell death. *Plant Physiol.*, **129**: 1908- 1920.
- Roos, W., Evers, S., Hieke, M., Tschöpe, M., and Schumann, B., 1998. Shifts of intracellular pH distribution as a part of the signal mechanism leading to the elicitation of benzophenanthridine alkaloids. *Plant Physiol.*, **118**: 349-364.
- Sanders, D., Brownlee, C., and Harper, J. F., 1999. Communicating with calcium. *Plant Cell*, **11**: 691-706.
- Sanders, D., Pelloux, J., Brownlee, C., and Harper, J. F., 2002. Calcium at the crossroads of signaling. *Plant Cell Suppl.*, **14**: S401-S417.
- Schaller, A., and Frasson, D., 2001. Induction of wound response gene expression in tomato leaves by ionophores. *Plant.*, **212**: 431-435.
- Schaller, A., and Oecking, C., 1999. Modulation of plasma membrane H⁺-ATPase activity differentially activates wound and pathogen defense responses in tomato plants. *Plant Cell*, **11**: 263-272.
- Schaller, A., Roy, P., and Amrhein, N., 2000. Salicylic acid-independent induction of pathogenesis-related gene expression by fusicoccin. *Planta*, **210**: 599-606.[
- Scharff, T.J., and Perry, A.C., 1976. The effects of salicylic acid on metabolism and potassium ion content in yeast. *Proc. Natl. Acad. Sci. USA.*, **151**: 72-77.
- Schneider-Müller, S., Kurosaki, F., and Nishi, A., 1994. Role of salicylic acid and intracellular Ca²⁺ in the induction of chitinase activity in carrot suspension culture. *Physiol. Mol. Plant Pathol.*, **45**: 101-109.
- Scholthof, H. B., 2005. Plant virus transport: motions of functional equivalence. *Trends Plant Sci.*, **10**: 376-382.
- Schroeder, J. I., and Hagiwara, S., 1989. Cytosolic calcium regulates ion channels in plasma membrane of *Vicia faba* guard cells. *Nature*, **338**: 427-430.
- Scott, A. C., and Allen, N. S., 1999. Changes in cytosolic pH within arabidopsis root columella cells play a key role in the early signaling pathway for root gravitropism. *Plant Physiol.*, **121**: 1291-1298.
- Seo S., Okamoto M., Seto, H., Ishizuka, K., Sano, H., and Ohashi, Y., 1995. Tobacco MAP kinase: a possible mediator in wound signal transduction pathways. *Science*, **270**: 1988-1992.
- Serova, V. V., Raldugina, G. N., and Krasavina, M. S., 2006. Inhibition of callose hydrolysis by salicylic acid disturbs transport of tobacco mosaic virus. *Dokl. Biol. Sci.*, **406**: 705-708.
- Shah, J., and Klessig, D. F., 1996. Identification of a salicylic acid-responsive element in the promoter of the tobacco pathogenesis-related β -1,3-glucanase gene, PR-2d. *Plant J.*, **10**: 1089-1101.
- Shettel, N.L., and Balke, N.E., 1983. Plant growth response to several allelopathic chemicals. *Weed Sci.*, **31**: 293-298.
- Shimoura, T., and Dijkstra, J., 1975. The occurrence of callose during the process of local lesion formation. *Neth. J. Plant Path.*, **81**: 107-121.
- Siegrist, J., Jeblick, W., and Kauss, H., 1994. Defense responses in infected and elicited cucumber (*Cucumis sativum* L.) hypocotyls segments exhibiting acquired resistance. *Plant Physiol.*, **105**: 1365-1374.

- Simon-Plas, F., Rustérucchi, C., Milat, M.-L., Humbert, C., Montillet, J.-L., and Blein, J.-P., 1997. Active oxygen species production in tobacco cells elicited by cryptogein. *Plant Cell Environ.*, **20**: 1573-1579.
- Singh, D. P., Moore, C. A., Gilliland, A., and Carr, J. P., 2004. Activation of multiple antiviral defence mechanisms by salicylic acid. *Mol. Plant Pathol.*, **5**: 57-63.
- Stäb, M. R., and Ebel, J., 1987. Effects of Ca²⁺ on phytoalexin induction by fungal elicitor in soybean cells. *Arch. Biochem. Biophys.*, **257**: 416-423.
- Strasser, H., Tjetien, K. G., Himmelspach, K., and Matern, U., 1983. Rapid effect of an elicitor on uptake and intracellular distribution of phosphate in cultured parsley cells. *Plant Cell Rep.*, **2**: 140-143.
- Sun, Y-L, Zhao, Y, Hong, X., and Zhai, Z-H., 1999. Cytochrome *c* release and caspase activation during menadione-induced apoptosis in plants. *FEBS Lett.*, **462**:317-321.
- Susin, S. A., Zamzami, N., and Kroemer, G., 1998. Mitochondria as regulators of apoptosis: doubt no more. *Biochem. Biophys. Acta*, **1366**: 151-165.
- Suzuki, K., and Shinshi, H., 1995. Transient activation and tyrosine phosphorylation of a protein kinase in tobacco cells treated with fungal elicitors. *Plant Cell*, **7**: 639-647.
- Tena, G., and Renaudin, J-P., 1998. Cytosolic acidification but not auxin at physiological concentration is an activator of MAPkinases in tobacco cells. *Plant J.*, **16**: 173-182.
- Tester, M., and MacRobbie, E. A. C., 1990. Cytoplasmic calcium affects the gating of potassium channels in the plasma membrane of *Chara corallina*: a whole-cell study using calcium-channel effectors. *Planta*, **180**: 569-581.
- Thain, J. F., Doherty, H. M., Bowles, D. J., and Wildon, D. C., 1990. Oligosaccharides that induce proteinase inhibitor activity in tomato plants cause depolarization of tomato leaf cells. *Plant Cell Environ.*, **13**: 569-574.
- Thain, J.F., Gubb, I.R., and Wildon, D.C., 1995. Depolarization of tomato leaf cells by oligogalacturonide elicitors. *Plant Cell Environ.*, **18**: 211-214.
- Thulke, O., and Conrath, U., 1998. Salicylic acid had dual role in the activation of defence-related genes in parsley. *Plant J.*, **14**: 35-42.
- Tiwari, B. S., Belenghi, B., and Levine, A., 2002. Oxidative stress increased respiration and generation of reactive oxygen species, resulting in ATP depletion, opening of mitochondrial permeability transition, and programmed cell death. *Plant Physiol.*, **128**: 1271-1281.
- Tomiyaama, K., Okamoto, H., and Katou, K., 1983. Effect of infection by *Phytophthora infectans* on the membrane potential of tomato cell. *Physiol. Plant Pathol.*, **22**: 233-243.
- Ton, J., and Mauch-Mani, B., 2004. β -Amino-butyric acid-induced resistance against necrotrophic pathogens is based on ABA-dependent priming for callose. *Plant J.*, **38**: 119-130.
- Tucker, E. B., 1990. Calcium-loaded 1,2-bis(2-aminophenoxy)ethane-N,N,N',N'-tetra acetic acid blocks cell-to-cell diffusion of carboxyfluorescein in staminal hairs of *Setcreasea purpurea*. *Planta*, **182**: 34-38.
- Tucker, E. B., and Boss, W. F., 1996. Mastoparan induced intracellular Ca²⁺ fluxes may regulate cell-to-cell communication in plants. *Plant Physiol.*, **111**: 459-467.
- Tunstall, M.J., Gale, J.E., and Ashmore, J.F., 1995. Action of salicylate on membrane capacitance of outer hair cells from the guinea-pig-cochlea. *J. Physiol.*, **485**: 739-752.
- Vera-Estrella, R., Barkla, B. J., Higgins, V. J., and Blumwald, E., 1994. Activation of host plasma membrane H⁺-ATPase by elicitor-induced enzyme dephosphorylation. *Plant Physiol.*, **104**: 209-215.
- Vidal, S., de León, I. P., Denecke, J., and Palva, E. T., 1997. Salicylic acid and the plant pathogen *Erwinia carotovora* induce defense genes via antagonistic pathways. *Plant J.*, **11**: 115-123.

- Vögeli-Lange, R., Hansen-Gehri, A., Boller, T., and Meins, F., Jr., 1988. Induction of the defense-related glucanohydrolases, β -1,3-glucanase and chitinase, by tobacco mosaic virus infection of tobacco leaves. *Plant Sci.*, **54**: 171-176.
- von Ahsen, O., Renken, C., Perkins, G., Kluck, R. M., Bossy-Wetzler, E., and Newmeyer, D. D., 2000. Preservation of mitochondrial structure and function after Bid or Bax-mediated cytochrome *c* release. *J. Cell Biol.*, **150**: 1027-1036.
- Waigmann, E., and Zambryski, P., 1995. Tobacco mosaic virus movement protein-mediated protein transport between trichome cells. *Plant Cell*, **7**: 2069-2079.
- Waigmann, E., Lucas, W. J., Citovsky, V., and Zambryski, P., 1994. Direct functional assay for tobacco mosaic virus cell-to-cell movement protein and identification of a domain involved in increasing plasmodesmatal permeability. *Proc. Natl. Acad. Sci. USA.*, **91**:1433-1437.
- Waldmann, T., Jeblick W., and Kauss, H., 1988. Induced net Ca^{+2} uptake and callose biosynthesis in cultured plant cells. *Planta*, **173**: 88-93.
- Wang, T.S.C., Yang, T.K., and Chaung, T.T., 1967. Soil phenolics as growth inhibitors. *Soil Sci.*, **103**: 239-246.
- Ward, J. M., Pei, Z-M., and Schroeder, I., 1995. Roles of ion channels in initiation of signal transduction in higher plants. *Plant Cell*, **7**: 833-844.
- Wei, M. C., Lindsten, T., Mootha, V. K., Weiler, S., Gross, A., Ashiya, M., Thompson, C. B., and Korsmeyer, S. J., 2000. tBid, a membrane-targeted death ligand, oligomerizes BAK to release cytochrome *c*. *Genes Dev.*, **14**: 2060-2071.
- White, R. G., Badelt, K., Overall, R. L., and Vesk, M., 1994. Actin associated with plasmodesmata. *Protoplasma*, **180**: 169-184.
- Whitehead, D.C., 1964. Identification of p-hydroxybenzoic, vanillic, p-coumaric, and ferulic acids in soil. *Nature*, **202**: 417-418.
- Wolf, S., Deom, C. M., Beachy, R. N., and Lucas, W. J., 1989. Movement protein of tobacco mosaic virus modifies plasmodesmata size exclusion limit. *Science*, **246**: 377-379.
- Wong, C. E., Carson, R. A. J., and Carr, J. P., 2002. Chemically induced virus resistance in *Arabidopsis thaliana* is independent of pathogenesis-related protein expression and the NPR1 gene. *Mol. Plant-Microbe Interact.*, **15**: 75-81.
- Wróbel-Kwiatkowska, M., Lorenc-Kukula, K., Starzycki, M., Oszmiański, J., Kepczyńska, E., and Szopa, J., 2004. Expression of β -1,3-glucanase in flax causes increased resistance to fungi. *Physiol. Mol. Plant Pathol.*, **65**: 245-256.
- Wu, J. H., and Dimitman, J. E., 1970. Leaf structure and callose formation as determinants of TMV movement in bean leaves as revealed by UV irradiation studies. *Virology*, **40**: 820-827.
- Xie, Z., and Chen, Z., 1999. Salicylic acid induces rapid inhibition of mitochondrial electron transport and oxidative phosphorylation in tobacco cells. *Plant Physiol.*, **120**: 217-226.
- Yahalom, A., Lando, R., Katz, A., and Epel, B. L., 1998. A calcium-dependent protein kinase is associated with maize mesocotyl plasmodesmata. *J. Plant Physiol.*, **153**: 354-363.
- Yalpani, N., León, J., Lawton, M., and Raskin, I., 1993. Pathway of salicylic acid biosynthesis in healthy and virus-inoculated tobacco. *Plant Physiol.*, **103**: 315-321.
- Yalpani, N., Silverman, P., Wilson, T. M. A., Kleier, D. A., and Raskin, I., 1991. Salicylic acid is a systemic signal and an inducer of pathogenesis-related proteins in virus-infected tobacco. *Plant Cell*, **3**: 809-818.
- Yang, Y., Qi, M., and Mei, C., 2004. Endogenous salicylic acid protect rice plants from oxidative damage caused by ageing as well as biotic and abiotic stress. *Plant J.*, **40**: 909-919.
- Zambryski, P., and Crawford, K., 2000. Plasmodesmata: gatekeepers for cell-to-cell transport of developmental signals in plants. *Annu. Rev. Cell Dev. Biol.*, **16**: 393-421.

- Zhang, P.C., Keleshian, A.M., and Sachs, F., 2001. Voltage-induced membrane movement. *Nature*, **413** (6854): 428-432.
- Zhang, X., Dong, F. C., Gao, J. F., and Song, C. P., 2001a. Hydrogen peroxide-induced changes in intracellular pH of guard cells precede stomatal closure. *Cell Res.*, **11**: 37-43.
- Zhang, X., Miao, Y. C., An, G. Y., Zhou, Y., Shangguan, Z. P., Gao, J. F., and Song, C. P., 2001b. K⁺ channels inhibited by hydrogen peroxide mediate abscisic acid signaling in *Vicia* guard cells. *Cell Res.*, **11**: 195-202.
- Zhang, X., Wang, H., Takemiya, A., Song, C-P., Kinoshita, T., and Shimazaki, K-I., 2004. Inhibition of blue light-dependent H⁺ pumping by abscisic acid through hydrogen peroxide-induced dephosphorylation of the plasma membrane H⁺-ATPase in guard cell protoplasts. *Plant Physiol.*, **136**: 4150-4158.
- Zhen, X.-H., and Li Y.-Z., 2004. Ultrastructural changes and location of β -1,3-glucanase in resistant and susceptible cotton callus cells in response to treatment with toxin of *Verticillium dahliae* and salicylic acid. *J. Plant Physiol.*, **161**: 1367-1377.
- Zimmerli, L., Jakab, G., Métraux J.-P., and Mauch-Mani, B., 2000. Potentiation of pathogen-specific defense mechanisms in *Arabidopsis* by β -aminobutyric acid. *Proc. Natl. Acad. Sci. USA*, **97**: 12920-12925.

Chapter 4

ROLE OF HORMONAL SYSTEM IN THE MANIFESTATION OF GROWTH PROMOTING AND ANTISTRESS ACTION OF SALICYLIC ACID

F. M. SHAKIROVA

*Institute of Biochemistry and Genetics, Ufa Scientific Centre, Russian Academy of Sciences,
69 pr. Octyabrya, 450054, Ufa, Russia.*

Abstract: Salicylic acid (SA) is an endogenous plant growth regulator. When applied to wheat plants in concentration similar to that used in case of exogenous hormones (0.05 mM), SA causes growth promoting and protective effects against an abiotic stresses. SA was shown to cause changes in hormonal system associated with transitory parallel accumulation of IAA and ABA with no change in cytokinins, which took place in case of treatment of seeds before sowing as well as seedling treatment. SA-induced accumulation of ABA lead to no detrimental effects, evidenced by clearcut stimulation of growth of root cells both by division and expansion, accumulation of raw and dry mass of seedlings and productivity of wheat treated with SA. This indicated an important role to IAA in the expression of growth stimulating action of SA. ABA is likely to be intermedator in manifestation of antistress action of SA. This is evidenced by the data showing that SA-induced accumulation of ABA was followed by enhanced expression of genes of dehydrins and accumulation of proline, i.e. substances having a relation with osmoprotection of cells. Moreover, SA causes activation of superoxide dismutase and peroxidase, including anionic peroxidase, phenylalanin-ammonia-lyase, favouring accelerated lignification of cell walls of seedlings roots. This is likely to contribute to a decline in the extent of injurious effects of salinity and water deficit on plants, pretreated with SA, evidenced by a decline in the level of lipid peroxidation and leakage of electrolytes from plant tissues as well as by more intensive growth processes as compared to control plants. It is important to underline that pretreatment with SA prevents a sharp decline in IAA and cytokinin content observed under stress and maintains a high level of ABA. Such a character of SA effect on the state of hormonal system may well contribute to protective reactions of plants and acceleration of reparative processes during a post-stress period.

Key words: Salicylic acid, salinity, abscisic acid, indoleacetic acid, cytokinins, proline, dehydrin, prooxidant-antioxidant balance

1. INTRODUCTION

Salicylic acid (SA) is an endogenous growth regulator of phenolic nature, which participates in the regulation of different physiological processes in plants. SA, for example, might play a role of natural inductor of thermogenesis in *Arum* lily, induce flowering in a range of plants, controls ions uptake by roots and stomatal conductivity (Raskin, 1992). There are experimental data indicating participation of SA in signalling and regulation of gene expression in the course of leaf senescence in *Arabidopsis* (Morris *et al.*, 2000). Moreover SA might serve as a regulator of biogenesis of chloroplasts (Uzunova and Popova, 2000) and activity of photosynthesis (Fariduddin *et al.*, 2003), gravitropism (Medvedev and Markova, 1991), inhibition of fruit ripening (Srivastava and Dwivedi, 2000) and of other processes.

However, recently this substance has drawn attention of researchers because of its ability to induce system acquired resistance (SAR) in plants to different pathogens, which is manifested as appearance of pathogenesis related proteins (PR), while SA is considered to serve as a signal in the induction of expression of these genes (Ward *et al.*, 1991; Metraux, 2002).

Moreover, a considerable interest has been generated by the ability of SA to produce protective effects in plants under the action of abiotic stress factors. Thus convincing data have accumulated about the SA-induced increase in the resistance of wheat seedlings to salinity (Shakirova and Bezrukova, 1997; Shakirova *et al.*, 2003; Sakhabutdinova *et al.*, 2004), and water deficit (Bezrukova *et al.*, 2001; Singh and Usha, 2003), maize (Janda *et al.*, 1999), cucumber and rice to low temperature (Kang and Saltveit, 2002), tomato and bean plants to low and high temperature (Senaratna *et al.*, 2000), as well as about injurious action of heavy metals on rice plants (Mishra and Choudhuri, 1999) and freezing on winter wheat leaves (Tasgin *et al.*, 2003).

The important role of SA in protective action is probably played by its ability to induce the expression of genes coding not only for PR-proteins but also, for gene of extensin in *Arabidopsis* plants (Merkouropoulos *et al.*, 1999). There are reports about SA induced synthesis of heat shock proteins in tobacco plants (Burkhanova *et al.*, 1999) and accumulation of wheat lectin (Shakirova and Bezrukova, 1997), fast activation of 48-kD protein kinase in suspension cell culture of tobacco at osmotic stress (Mikolajczyk *et al.*, 2000). This shows the participation of SA in realization of different

antistress programs. However the routes of signal regulation in plant resistance to abiotic factors of environment are still not clear enough. Progress in understanding this problem can, however, be achieved by a complex study of the mechanisms of SA action in plants under normal and stressful conditions of growing.

2. INFLUENCE OF SA ON GROWTH AND HORMONAL STATUS OF WHEAT PLANTS

Since salicylic acid is an endogenous growth regulator, it was important to study the influence of exogenous SA on intensity of growth processes in wheat plants. In order to reach this goal two types of treatments on wheat (*Triticum aestivum* L., *Saratovskaya 29*) with a concentration of SA (0.05 mM), optimal for seedling growth, have been planned (a) soaking of seeds (Shakirova and Bezrukova, 1997; Shakirova *et al.*, 2003) and (b) treatment of intact seedlings (Sakhabutdinova *et al.*, 2004).

2.1 Soaking of seeds in SA

In order to study the action of SA, under laboratory conditions, the seeds were soaked in 0.05 mM SA solution for 3 h and then were germinated for 5 d on moist filter paper in cuvetters (24-h light/dark photoperiod with the light phase duration of 16 h; light intensity, 15 klx; temperature; 22-24°C). Estimation of the influence of presowing seed treatment with 0.05 mM SA on hormonal status of leaves and milky grains and various characteristics in wheat were carried out in microplots (2 m²) in the field of Chishminsky Crop Production, Bashkortostan, Russia.

Presowing seed treatment with SA leads to an activation of germination and seedling growth (Shakirova *et al.*, 2003), while the enhancement of the division of root apical cells is an important contribution to the growth stimulating effect of SA (Table 1). This effect was also revealed in field experiments when elements of yield structure were analysed. As evident from table 2, plants pretreated with SA were characterized with increased size of ears, mass of 1000 seeds and grain yield, indicating prolonged effect of presowing treatment of seeds, which produced stimulative effect on the productivity of wheat, at harvest.

Phytohormones are known to play a decisive role in the regulation of plant growth and development and thus it was important to study the effect of the treatment with SA on hormonal system of seedlings. Data presented on figure 1 demonstrates fast transitory shifts in hormonal balance of wheat seedlings in the course of germination under the influence of SA, associated

with simultaneous sharp accumulation of IAA and ABA with maximum on the second day, while noticeable changes in cytokinin level were not revealed. Thus growth promoting effect of SA on wheat seedlings was associated with the increase in the level of IAA, but it is necessary to underline that accumulation of ABA did not produce inhibitory effect on the growth of seedlings. Moreover, the intensity of growth processes of plants treated with SA was noticeably higher than in control (Table 1).

Table 1. Mitotic index of root meristem cells of wheat seedlings (Data are the mean \pm S.E. of three assays)

Age of seedlings	2-day		3-day		4-day	
	Control	SA	Control	SA	Control	SA
	3.0 \pm 0.07	4.0 \pm 0.10	3.2 \pm 0.10	5.2 \pm 0.13	3.5 \pm 0.06	5.3 \pm 0.11

Table 2. The effect of presowing treatment with salicylic acid on wheat productivity (Data are the mean \pm S.E. of three assays)

Variant	Quantity of seeds in main ear	Seeds weight in ear, g	Weight of 1000 seeds (g)	Yield, g m ⁻²
Control	18.7	0.67	35.5	199
SA	23.7 (127%)	0.93 (139%)	38.2 (115%)	272 (137%)

Analysis of hormone content in wheat plants in the course of ontogenesis of wheat plants revealed a parallel accumulation of IAA and ABA in leaves in the phase of tillering albeit this study as well as the previous one concerning seedlings revealed no significant change in cytokinin concentration (Figure 2a). Thus observed changes in the concentration of IAA under the impact of SA are important in the regulation of growth and development of young wheat plants, playing a significant role in the activation of growth processes and the accumulation of ABA probably enhancing unspecific resistance of wheat plants.

In milky grains (14 days, after flowering) changes in hormone balance are mainly manifested to two fold increases in the level of cytokinins (Figure 2b) known to play an important role in the control of grain development, in the course of its maturation. This is likely to make an important contribution in the control of grain size and mass during the period of its filling, since by the time the crop is harvested the mass of grains obtained from experimental plants significantly exceeded those of the control ones (Table 2).

An important contribution, in the control of grain development, is attributed to ABA, which is due not only to its involvement in the assimilate

attraction (alongside with cytokinins and auxins) but also to induced synthesis of storage proteins, control of germ dormancy and inhibition of germination (Rademacher and Grabe, 1984; Bewley, 1997).

Thus shift in the balance of phytohormones induced by preseedling treatment with SA are of great importance for the growth stimulating action of SA on wheat plants.

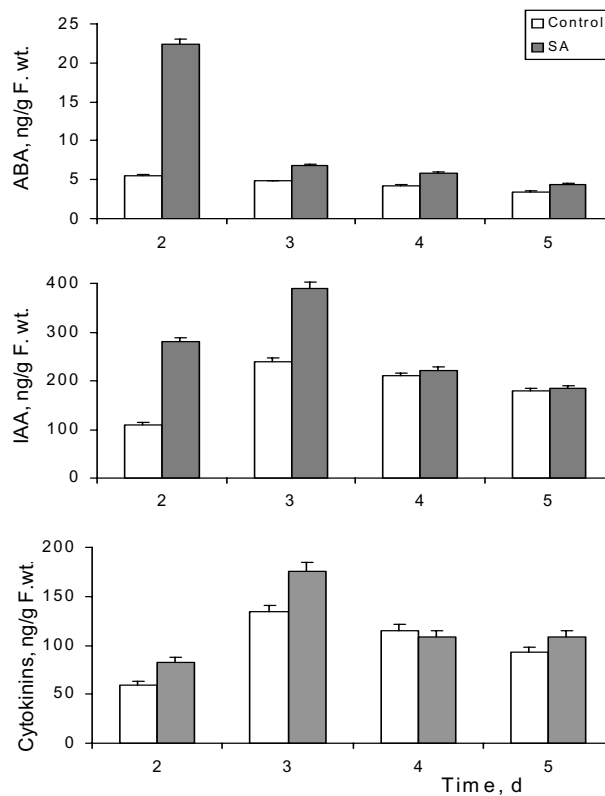

Figure 1. The effect of presowing seed treatment with 0.05mM SA on phytohormone content in wheat seedlings. Data are mean \pm S.E. of three assays.

2.2 Treatment of seedlings with SA

The 0.05 mM SA has prominent growth stimulating effects when applied to seedlings. Incubation of seedlings on a solution of SA during a day leads to noticeable increase in their linear size and weight (Figure 3). Clearly expressed influence of SA on mitotic activity of cells of apical meristem contributes significantly to its growth stimulating effect. Thus mitotic index (MI) of cells of root apical meristem was increased by 70 %, 24 hours after the start of SA treatment.

As in case of presowing treatment parallel transitory accumulation of IAA and ABA is induced by SA treatment of seedlings (Figure 4), that is the way to achieve its growth promoting effect on wheat plants. Alongside with this, SA-induced an increase in ABA content that might have contributed to preadaptation of plants to different stressful influences not only of abiotic but also of biotic nature, since ABA is ascribed to have a key role in triggering protective reactions of plants, in induction of the synthesis of a range of stress proteins (Rock, 2000) and a range of PR-proteins (Moons *et al.*, 1997) in particular.

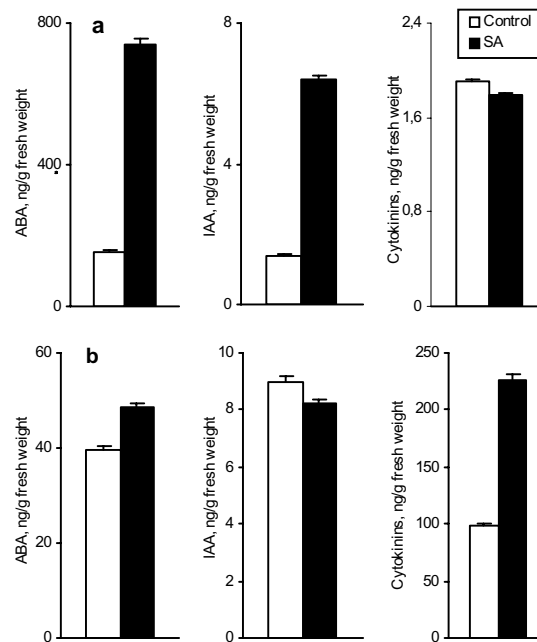

Figure 2. The influence of presowing seed treatment with 0.05 mM SA on hormonal status during wheat ontogenesis. Mean data of three independent replicates and their S.E. are presented.

Accumulation of proline, which is a well-known effective cell osmoprotectant (Pesci, 1987; Kuznetsov and Shevyakova, 1999), might serve as an example of such reactions. Consequently, it is reasonable to suggest a significant role of ABA-controlled changes in the concentration of proline in SA-induced preadaptation of wheat plants to stress factors, which disturb water relations. The treatment of seedlings with SA caused a significant increase in the concentration of proline in seedlings, which reached a level about 3-4 times, within 7 hours, compared with the control (Figure 5a). Increase in the concentration of proline was preceded by a

transitory accumulation of ABA, induced by SA treatment that indicates the involvement of endogenous ABA in the control of accumulation of proline in cells (Figure 5a). The data obtained is an evidence for the implication of proline in the spectrum of the mechanism of SA action in wheat plants, which is achieved through its influence on the accumulation of ABA.

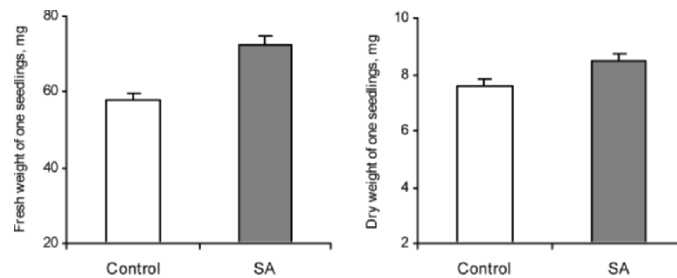

Figure 3. The effect of 1-day treatment with 0.05 mM SA on fresh and dry weight of 5-day-old wheat seedlings. S.E.s of three assays are indicated.

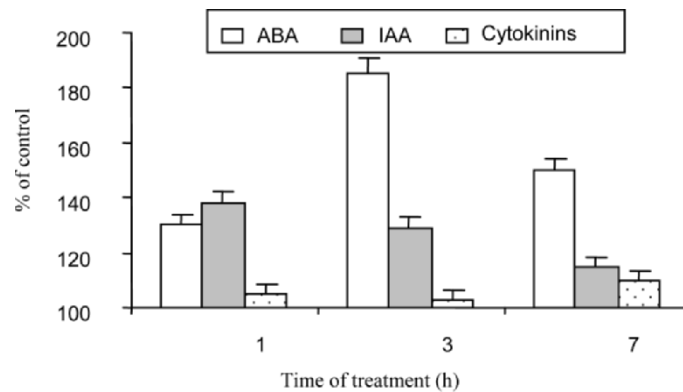

Figure 4. The effect of treatment of 4-day-old seedlings with 0.05 mM SA on phytohormone content. Data are mean \pm S.E. of three assays.

Another example illustrating the key role of ABA in the expression of protective action of SA on wheat plants is presented by the results of experiments showing the influence of SA on the dynamics of ABA accumulation and level of transcription activity of wheat dehydrin gene *TADHN*. Dehydrins are related to rab-(ABA-responsible) proteins. They belong to LEA-(late embryogenesis abundant) proteins, whose synthesis is dated to the stage of grain maturation accompanied by dehydration (Close, 1996; Rock, 2000). Alongside with these protective functions of dehydrins manifested in their ability to retain water and to prevent denaturation of cell biopolymers under dehydration turned out to be useful for vegetating plants

under conditions leading to disturbance in water relations (Allagulova *et al.*, 2003). It was revealed by us earlier that ABA treatment of wheat seedlings results in an increase in the expression of dehydrin gene *TADHN* (Shakirova *et al.*, 2005). Data presented in figure 5b, demonstrates the ability of SA to increase the level of dehydrin mRNA, which is preceded by SA-induced accumulation of ABA. These data indicate the involvement of dehydrins in the spectrum of ABA-mediated protective action of SA on wheat plants.

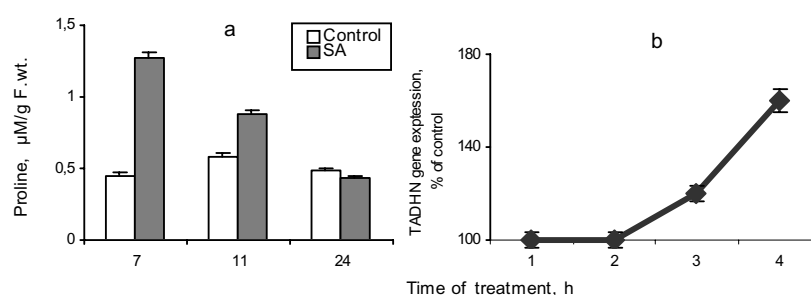

Figure 5. The effect of treatment of 4-day-old seedlings with 0.05 mM SA on proline content (a) and level of wheat dehydrin gene *TADHN* expression (b). Mean data of three independent replicates and their S.E. are presented.

Taking into account the fact of the observed participation of ABA in the control of osmoprotectors, we may make a conclusion concerning the important role of stress hormone ABA in the expression of preadaptive action of SA on wheat plants. Consequently ABA might have served as an intermediate in the development of SA-induced mechanisms of preadaptation of wheat plants to possible stress factors, leading to the disturbance of water relations.

It is important to underline that SA caused similar changes in hormonal balance of wheat plants with both variants of SA-treatment, which is likely to explain its growth promoting and protective action.

3. MECHANISMS OF PROTECTIVE EFFECTS OF SA ON WHEAT PLANTS, UNDER SALINITY

3.1 Effect of pretreatment with SA on growth and balance of phytohormones of wheat seedlings

Salinity results in a decline in metabolic activity of plant cells (Ramagopal, 1987), which should be inevitably reflected as inhibition of

their growth. Action of 2% NaCl on 4-d-old wheat seedlings led to a noticeable and almost equal extent of inhibition of growth of plants both with or without SA treatment, however, by the start of experiment seedlings pretreated with SA had greater biomass compared to control (Figure 6) and even after the action of 2% NaCl this characteristic was still higher than in control (not exposed to NaCl).

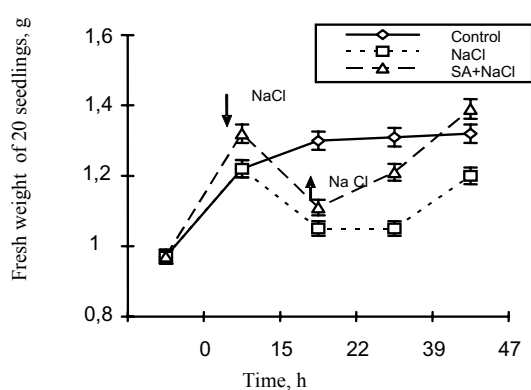

Figure 6. The effect of pretreatment of wheat seedlings with 0.05 mM SA on their fresh mass under salinity. 4-d-old seedlings after treatment with SA were subjected to 2% NaCl for 7 h.

Data are mean \pm S.E. of three assays.

Moreover, the treatment with SA accelerated reparation of growth processes in seedlings after this stress as evidenced by the results of analysis of mitotic activity of root meristem cells of 4-5-d-old seedlings (Table 3).

Table 3. Mitotic index (%) of root meristem cells of wheat seedlings, under salinity (Data are the mean \pm S.E. of three assays)

Variant	Before influence 2%NaCl	2%NaCl (7 ч)	One day after 2%NaCl
Control	3.52 \pm 0.06	2.90 \pm 0.05	2.92 \pm 0.07
SA	5.31 \pm 0.11	3.51 \pm 0.08	5.50 \pm 0.1

Incubation in 2% NaCl for 7 h led to an inhibition of cell division of not only roots of untreated seedlings but also that of pretreated with SA. However, it is necessary to underline the observations that initially cells of root meristem of these seedlings were characterized by significantly higher MI (mitotic index) but salinity decreased MI of cells down to the level that

of the control plants, grown under normal conditions. Moreover, root meristem cells of seedlings pretreated with SA completely restored their high level of mitotic activity after a short-term effect of salinity, the untreated plants did not recover (Shakirova *et al.*, 2003). Thus, the results of these experiments evidence an SA-induced activation of division at root meristem cells, which contributed to SA-induced growth of wheat seedlings, and also maintains high intensity of mitotic activity in seedlings under salinity. Such an effect of SA on cell division is likely to be an important mechanism, which enables not only a decline in the extent of injurious effect of this stress factor on growth in general, but also accelerates the resumption of growth processes in seedlings during recovery after being exposed to salinity.

Pretreatment of wheat with SA contributes to the development of resistance in plants to salinity. It may be assumed that SA-induced changes at the level of transcription of dehydrin gene *TADHN* and the increased concentration of proline in seedlings, in the course of pretreatment with this growth regulator, might have served as an important contributor to protect the plants from salinity-induced dehydration.

In order to understand the mechanisms of the protective effects of SA on growth, we carried out analysis of the state of hormonal system in plants pretreated and untreated with SA grown under salinity. Unfavourable environmental conditions generate to sharp changes in the balance of phytohormones, associated not only with the accumulation of ABA, but also with the decline in the level of growth activating hormones, IAA and cytokinins (Jackson, 1993; Zholkevich and Pustovoytova, 1993).

In fact, as seen from figure 7, incubation of seedlings on the medium containing 2% NaCl results in transitory accumulation of ABA and decline in cytokinins as well as a limited decrease in the level of IAA. The pretreatment with SA (Figure 7) completely prevented salinity-induced decline in the concentration of IAA and cytokinins in the seedlings and reduced accumulation of ABA, which could be a prerequisite for the resumption of accelerated growth of wheat seedlings, after the withdrawal of stressor from the medium.

Along with this, maintenance of comparatively higher level of ABA, under stress conditions, in plants pretreated with SA is of primary importance from our point of view because ABA might serve as an important regulating factor in SA-induced unspecific plant resistance.

3.2 Influence of SA on the state of prooxidant-antioxidant system in wheat plants

Stress-factors are well-known to cause a shift in the prooxidant-antioxidant balance in plant cells. This shift is due to an increase in the rate of generation of reactive oxygen species (ROS), which induce lipid peroxidation (LPO) in the membrane structures of the cells (Zenkov *et al.*, 2001; Tarchevskii, 2002). Antioxidant system plays an important role in the process of neutralization of the after effects of oxidative stress. The literature contains evidences of SA-induced effects on the rate of generation of O_2^- and H_2O_2 (Chen *et al.*, 1993; Minibayeva *et al.*, 2001) and the activity of

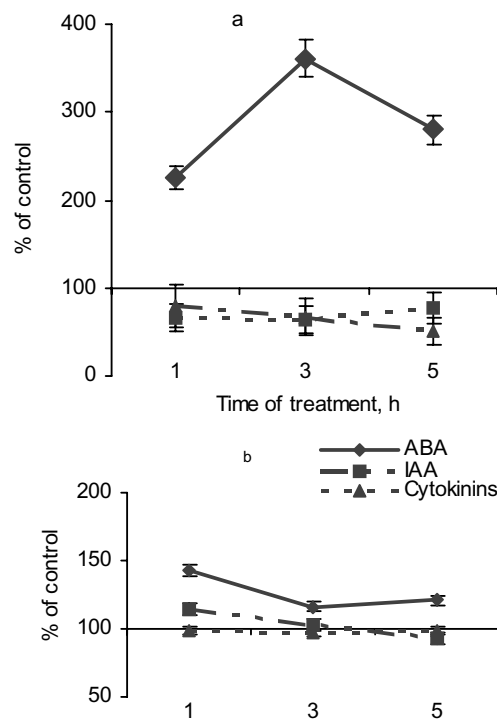

Figure 7. The influence of salinity on hormonal status in wheat seedlings, untreated (a) and pretreated with SA (b). Data are mean \pm S.E. of three assays.

superoxide dismutase (SOD), peroxidase, and catalase, i.e., the enzymes involved in the utilization of ROS (Janda *et al.*, 1999; Senaratna *et al.*, 2000; Kang and Saltveit, 2002). However, at the time when this work was planned, there were no reports in the literature on the effects on the level of ROS and

changes in the activity of the ROS-detoxifying system in wheat plants exposed to stress-factors. On the other hand, this information is important for understanding the mechanisms of the antistress effects of SA in plants, which is a prerequisite to justify the use of this natural growth regulator for increasing wheat resistance to salinity.

3.2.1 Normal conditions of growing

Treatment of seedlings with SA caused a transitory enhancement of O_2^- and H_2O_2 production by plants and simultaneous increase in the activity of SOD (Figure 8), which is one of key enzymes of antioxidant system (Wu *et al.*, 1999; Alscher *et al.*, 2002). Dismutation of O_2^- with the help of SOD results in the accumulation of H_2O_2 in the control tissues, where the important role is attributed to peroxidase. Consequently it is not surprising that enhancement of the generation of H_2O_2 in SA treated seedlings is accompanied by the activation of peroxidase (Figure 8). These results confirm the fact of enhancement of production of O_2^- and H_2O_2 under the influence of SA (Minibayeva *et al.*, 2001; Kawano *et al.*, 2003), and activity of SOD (Vuletic *et al.*, 2003) and peroxidase (Janda *et al.*, 1999; Kang and Salveit, 2002) in plants. Along with this it is also known that a low level of ROS generation may play an important role in the preadaptive activity of SA in seedlings with respect to extended stress situations, because it is well known that ROS acts as signaling molecules that triggers the cascade of protective reactions in plants (Tarchevskii, 2002), including activation of antioxidant enzymes, favouring a decrease in the level of stress-induced generation of ROS, under subsequent conditions of stressful environment.

The data showing SA-induced SOD activation in wheat plants was consistent with the results obtained with other various plant species: maize (*Zea mays* L.), cucumber (*Cucumis sativus* L.), and rice (*Oriza sativa* L.). These plants demonstrated an increase in the activity of SOD and, therefore, SA-induced development of resistance to further hypothermia (Kang and Salveit, 2002). The effect of SA on the activation of SOD may facilitate the integrity of membrane structures of the cell, because SOD is involved in the processes of LPO deactivation (Zenkov *et al.*, 2001). Elevation of total cell SOD may be associated both with changes in the activity of latent isozymes of SOD and with de novo biosynthesis of this enzyme. It is well known that ABA is involved in the process of induction of the expression of genes, encoding proteins involved in plant stress responses (Rock, 2000), including the genes of SOD (Sakamoto *et al.*, 1995). Moreover there are data that water stress-induced accumulation of ABA in maize leaves resulted in the enhancement in the activity of SOD (Jiang and Zhang, 2002). Therefore, we assume that SA-induced activation of SOD is due to its effect on ABA, but

this suggestion should be tested experimentally. Our data show that SA is involved in the regulation of peroxidase activity, which controls intracellular concentration of H₂O₂. Therefore, it is safe to suggest that this enzyme contributes to the preadaptation effect of SA on wheat plants. Indeed, there is evidence in the literature that pretreatment with SA for 1 day increased peroxidase activity in maize plants. This fact offered an explanation for SA-induced resistance of plants to low temperature (Janda *et al.*, 1999). The ability of SA to stimulate H₂O₂ production and activation of peroxidase system may play an important role in biochemical processes associated with the biosynthesis of lignin and suberin, which are involved in the strengthening of barrier properties of cell walls (Kolattukudy *et al.*, 1995). On the other hand, the effect of SA on the activation of SOD may facilitate the integrity of membrane structures of the cell, SOD being involved in the deactivation of LPO processes (Zenkov *et al.*, 2001).

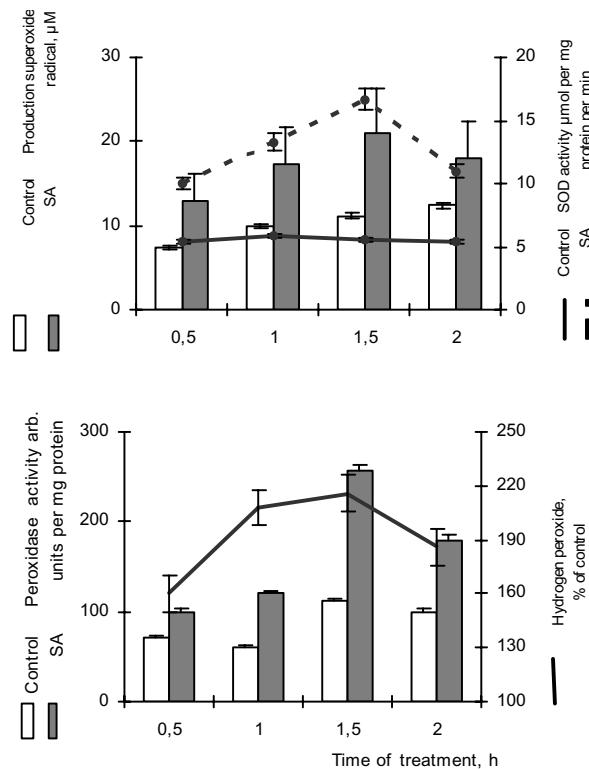

Figure 8. The effects of the treatment of 4-day-old wheat seedlings with 0.05 mM SA on the production of ROS and activity of SOD and peroxidase in plants. Mean data of three independent replicates and their S.E. are presented.

Thus, the data obtained by us demonstrate the ability of SA to cause simultaneous and reversible changes in the level of the production of ROS and activity of antioxidant enzymes in wheat seedlings and as a result of this the prooxidant-antioxidant balance is not disturbed, which is illustrated by the absence of noticeable changes in the concentration of the final LPO product, malonic dialdehyde (MDA) (Figure 10) and by the clearly expressed growth promoting effect of SA on plants. At the same time, activation of antioxidant enzymes induced by the treatment with SA may contribute to its antistress effects in plants.

3.2.2 Effect of SA on the pro-antioxidant balance in wheat seedlings under salinity stress

It is known that stress-factors of various origins induce the generation of ROS in cells. Therefore, it was not surprising that incubation of four-day-old seedlings in a medium containing 2% NaCl caused a significant increase in the concentration of O_2^- and H_2O_2 in roots (Sakhabutdinova *et al.*, 2004), which was fairly consistent with the data on the enhancement of ROS generation in plants exposed to salinity (Mittova *et al.*, 2004). Concentrations of O_2^- and H_2O_2 in seedlings pretreated with SA and incubated with 2% NaCl were substantially less than in untreated seedlings (about a 50%). Similar picture was observed when activity of SOD and peroxidase was estimated in roots of seedlings pretreated with SA. A sharp stress-induced increase in the concentration of ROS may have severe destructive consequences, which require ROS neutralization by antioxidant enzymes. Therefore, our subsequent experiments involved measurement of SOD and peroxidase activities in roots of seedlings under salinity.

Figure 9 shows that salinity causes a significant increase in the activity of SOD and peroxidase in roots of seedlings, which may be associated with a significant increase in the rate of generation of O_2^- and H_2O_2 . On the other hand, this parameter in seedlings pretreated with SA and incubated with 2% NaCl was substantially lower than in untreated seedlings.

The balance between antioxidant system and LPO is an important prerequisite for normal functioning of cells, because of the direct correlation between the stress-factor intensity and the rate of ROS generation (i.e., LPO development). Concentration of MDA can serve as an indicator of the rate of oxidative processes in cell. In untreated seedlings, the addition of 2% NaCl caused only insignificant changes in the concentration of MDA, the effect remained at a low level even after 7 h of incubation (concentration changes did not exceed 30% of the control level). This parameter in the seedlings pretreated with SA was indistinguishable from that in control plants. However, following 1-day exposure to salinity, there was a twofold increase

in the level of MDA in untreated seedlings, whereas pretreatment with SA brought about a 50% decrease in the concentration of MDA (Figure 10a). This could be the consequence of the preadaptation effect of SA on wheat plants, in which SA-induced events leading to activation of the antioxidant system were initiated before the exposure of the plants to 2% NaCl. This may facilitate the strengthening of cell walls and effectively neutralize excessive (damaging) increase in the level of ROS during further exposure to the stress-factor, thereby preventing the damage of cellular membrane structures and changes in their permeability under stress conditions. The results of the measurement of leakage of electrolytes may provide information on cell membrane permeability changes: incubation in 2% NaCl for 3 h exerted a strong damaging effect on cells, judging by the two-fold increase in the rate of release of electrolytes, compared to the control (Figure 10b). Pretreatment with SA for 24 h protected wheat plants against the salinity-induced damage, which was manifested as a substantial decrease in the rate of the stress-induced leakage of electrolytes. The SA pre-treatment for 1 day did not cause any substantial increase in the rate of release of electrolytes itself, which indicated that SA-induced effect was favorable for the plants. This conclusion is supported by the facts that pretreatment with SA stimulated cell growth in roots, and increased their fresh and dry mass.

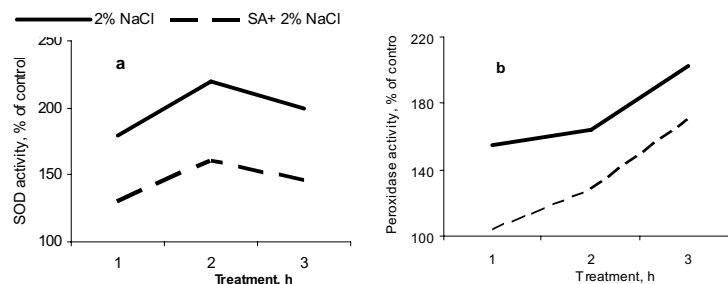

Figure 9. The effect of pretreatment with 0.05 mM SA on the activity of SOD and peroxidase in wheat seedlings, under salinity.

While discussing these results it is of interest to present the data showing that overproduction of dehydrins in *Citrus unshiu* Markov (CuCOR19) increases resistance of transgenic plants to hypothermy by decreasing cold-induced POL probably at the expense of direct neutralization of ROS (Hara *et al.*, 2004). Consequently we may suggest that dehydrins of wheat, which enhanced the observed expression under the effect of SA, might contribute to normalize pro/antioxidant balance of SA-treated seedlings.

As mentioned above the SA-treatment itself leads to the enhancement of H_2O_2 production and an increase in the total activity of peroxidase, involved

in lignin synthesis in roots of seedlings. Phenylalanin-ammonia-lyase (PAL) is known to play a key role in the synthesis of phenolic substances necessary for lignification (Dixon and Palva, 1995; Shadle *et al.*, 2003). There are data indicating the ability of SA to induce expression of the genes of PAL as well as anionic peroxidase (POX) in the cell culture of parsley (Thulke and Conrath, 1998). Our observation showed that SA increased the activity of PAL in the roots of wheat seedlings 12 hours after the start the treatment, with a maximum at 24 h. This allows us to suggest the involvement of SA in the acceleration of lignification of cell walls which in turn might have contributed to an increase in salt resistance of wheat plants.

Table 4 does show that in 2 days SA accelerated lignification of the cell walls of vasculatures as compared to the control. The treatment with 2% NaCl also lead to the acceleration of this process, however it was observed one day later than under SA-treatment alone. Alongside with this, pretreatment with SA contributed to the additional enhancement of lignification of cell walls of roots of seedlings under salinity. Thus, this set of data evidences that the increase in PAL activity, enhancement of ROS generation and activation of antioxidant enzymes in the course of SA treatment promoted additional strengthening of barrier properties of cell walls of roots under salinity, which might contribute to the increase in resistance of seedlings to this stress.

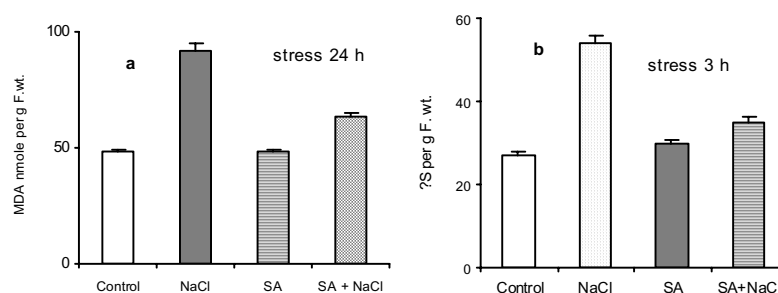

Figure 10. Effect of pretreatment with 0.05 mM SA on the concentration of MDA and leakage of electrolytes induces by the incubation of wheat seedlings in 2% NaCl.

Consequently, the changes in the state of prooxidant-antioxidant system presented by balanced activation of ROS generation and antioxidant enzymes, the increase in activity of PAL, acceleration of lignification of cell walls in roots of wheat seedlings, observed in the course of pretreatment with SA make an important contribution to the increase in resistance of wheat plants to subsequent action of salinity. This is expressed in a decline in the level of stress-induced POL, release of electrolytes and is reflected in

growth parameters of SA-treated plants and acceleration of reparation of growth processes after withdrawal of stress.

Table 4. Dynamics of lignin accumulation in basal part of roots of wheat seedlings pretreated and not treated with SA and after exposure to 2% NaCl for 24 h

Variants	5 days	6 days	7 days
Control	-	-	+
CK	+	+	++
2 % NaCl	-	+	++
CK + 2% NaCl	++	+++	++++

*4-days-old seedlings pretreated with SA were transferred to the solution of NaCl for 24 h; mark «-» indicates absence of colouring by phloroglucinol, mark «+» reflects the extent of colour intensity (Sedlarova and Lebeda, 2001).

4. CONCLUSION

The set of data obtained by the authors evidences the growth promotive and clearly pronounced protective action of SA on wheat plants under salinity. In expressing these properties a decisive role may be attributed to hormonal system responding sensitively to changes in the environment. The SA treatment induces a shift in hormonal balance coupled with transitory accumulation of IAA and ABA. We link growth promoting action of SA with accumulation of auxin, while its protective action may be explained by that of ABA, osmoprotectants contributing to the latter effect in a great extent. We revealed an increase in the concentration of proline and expression of wheat dehydrin gene in SA-treated seedlings preceded by SA-induced accumulation of ABA, which might promote an increase in their resistance to stress factors.

The effect of salicylic acid on the state of pro- and antioxidant system plays an important role in its protective action on wheat plants. Balanced, elevated generation of O_2^- and H_2O_2 and activity of SOD and peroxidase influenced by SA is likely to prepare plants for forthcoming oxidative stress caused by unfavorable factors decreasing its detrimental effect. It is not excluded that SA controls the activity of antioxidant enzymes through transit accumulation of ABA in wheat seedlings, which is evidenced by the data that indicates implication of ABA in the enhancement of the expression of SOD genes and activation of the enzyme. It is of interest to note that antioxidant activity was revealed in the spectrum of functions attributed to dehydrin, ABA participating in the control of dehydrin synthesis. Ability of SA to regulate production of ROS, activity of peroxidase and PAL correlates with the acceleration of lignification of cell walls under its influence, which

contributes in the protection of wheat plants to forthcoming stressful influences.

Present data clearly indicates that treatment of wheat seeds or that of seedlings with SA contributes to increase the resistance of plants to stress factors of the environment and ABA might serve as an intermediate in the protective action of SA.

Preadapting wheat plants by SA to salinity is illustrated by the data. This shows that SA treatment prevents a decline in the content of IAA and cytokinins and maintains increased level of ABA, over the control and reduces stress-induced generation of ROS and activation of antioxidant enzymes. In general, this is manifested as a decline in the level of injurious effect of salinity on the integrity of cell membrane in SA-treated plants, evidenced by a decline in POL and leakage of electrolytes. This is also indicated by the growth of seedlings and growth recovery during the period following stress withdrawal. It is important to underline that in our experiments we used 0.05 mM concentration of SA, which is comparable with that of the classical hormones, used for the treatment of plants in the study of the mechanism of their action. Data presented in this chapter allows us to consider endogenous growth regulator SA as an effective inductor of unspecific resistance of wheat plants, in whose regulation important role is assigned to the hormonal status and pro- antioxidant system.

5. ACKNOWLEDGEMENT

This research is supported by the Russian Foundation for Basic Research-Agidel (project no 05-04-97913) and NSh-1785.2003.4

6. REFERENCES

- Allagulova, Ch.R., Gimalov, F.R., Shakirova, F.M., and Vakhitov, V.A., 2003. The plant dehydrins: structure and putative functions. *Biochem. (Moscow)*, **68**:945-951.
- Alscher, R.G., Erturk, N., and Heath, L.S., 2002. Role of superoxide dismutases (SODs) in controlling oxidative stress in plants. *J.Exp. Bot.*, **53**:1331-1341.
- Bewley, J.D., 1997. Seed germination and dormancy. *Plant Cell*, **9**:1055-1066.
- Bezrukova, M.V., Sakhabutdinova, A.R., Fatkhutdinova, R.A., Kyldiarova, I.A., and Shakirova, F.M., 2001. The role of hormonal changes in protective action of salicylic acid on growth of wheat seedlings under water deficit. *Agrochemiya (in Russ)*, **2**:51-54.
- Burkhanova, E.A., Fedina, A.B., and Kulaeva, O.N., 1999. Effect of salicylic acid and (2'-5')-oligoadenylates on protein synthesis in tobacco leaves under heat shock conditions: A comparative study. *Russian J. Plant Physiol.*, **46**:16-22.
- Chen, Z., Silva, H., and Klessing, D.F., 1993. Active oxygen species in the induction of plant systemic acquired resistance by salicylic acid. *Science*, **262**:1883-1886.

- Close T.J., 1996. Dehydrins: Emergence of a biochemical role of a family of plant dehydration proteins, *Physiol. Plant.*, **96**:795-803.
- Dixon, R., and Paiva, N., 1995. Stress-Induced Phenylpropanoid Metabolism. *Plant Cell*, **7**:1085-1097.
- Fariduddin, Q., Hayat, S., and Ahmad, A., 2003. Salicylic acid influences net photosynthetic rate, carboxylation efficiency, nitrate reductase activity, and seed yield in *Brassica juncea*. *Photosynthetica*, **41**:281-284.
- Jackson M., 1993. Are plants hormones involved in root to shoot communication? In: J.A., Callow ed., *Adv. Bot. Res.*, **19**:103-187.
- Janda, T., Szalai, G., Tari, I., and Paldi, E., 1999. Hydroponic treatment with salicylic acid decreases the effects of chilling injury in maize (*Zea mays* L.) plant. *Planta*, **208**:175-180.
- Jiang, M., and Zhang, J., 2002. Water stress-induced abscisic acid accumulation triggers the increased generation of reactive oxygen species and up-regulates the activities of antioxidant enzymes in maize leaves. *J. Exp. Bot.*, **53**:2401-2410.
- Hara M., Fujinaga M., and Kuboi T., 2004. Radical scavenging and oxidative modification of citrus dehydrin. *Plant Physiol. Biochem.*, **42**:657-662.
- Kang, H-M., and Saltveit, M.E., 2002. Chilling tolerance of maize, cucumber and rice seedling leaves and roots are differentially affected by salicylic acid. *Physiol. Plant.*, **115**: 571-576.
- Kawano, T., 2003. Role of reactive oxygen species-generating peroxidase reactions in plant defense and growth induction. *Plant Cell Rep.*, **21**:829-837.
- Kolattukudy, P.E., Rogers, L.M., Li, D., Hwang, C.S., and Flaishman, M., 1995. Surface Signaling in Pathogenesis *Proc. Natl. Acad. Sci. USA.*, **92**:4080-4087.
- Kuznetsov, V.I., and Shevyakova, N.I., 1999. Proline under stress conditions: Biological role, metabolism, and regulation. *Russian J. of Plant Physiol.*, **46**:321-336.
- Medvedev, S.S., and Markova, I.V., 1991. Participation of salicylic acid in gravitropism in plants. *Dokl. Akad. Nauk SSSR (in Russ)*, **316**:1014-1016.
- Merkouropoulos, G., Barnett, D.C., and Shirsat, A.H., 1999. The arabidopsis extensin gene is developmentally regulated, is induced by wounding, methyl jasmonate, abscisic and salicylic acid, and codes for a protein with unusual motifs. *Planta*, **208**:212-219.
- Metraux, J.P., 2002. Recent breakthroughs in study of salicylic acid biosynthesis. *Tr. Plant Sci.*, **7**:331-334.
- Mikolajczyk, M., Awotunde, O.S., Muszynska, G., Klessig D.F., Dobrowolska G., 2000. Osmotic stress induces rapid activation of a salicylic acid-induced protein kinase and a homolog of protein kinase ASK1 in tobacco cell. *Plant Cell*, **12**:165-178.
- Minibayeva F.V., Gordon, L.K., Kolesnikov, O.P., and Chasov, A.V., 2001. Role of extracellular peroxidase in the superoxide production by wheat root cells. *Protoplasma*, **217**:125-128.
- Mishra, A., and Choudhuri, M.A., 1999. Effect of salicylic acid on heavy metal-induced membrane deterioration mediated by lipoxygenase in rice. *Biol. Plant.*, **42**:409-415.
- Mittova, V., Guy, M., Tal, M., and Volokita, M., 2004. Salinity up-regulates the antioxidative system in root mitochondria and peroxisomes of the wild salt-tolerant tomato species *Lycopersicon pennellii*. *J. Exp. Bot.*, **55**:1105-1113.
- Moons, A., Prinsen, E., and van Montagu, M., 1997. Antagonistic effect of abscisic acid and jasmonates on salt stress-inducible transcripts in rice roots. *Plant Cell*, **9**:2243-2259.
- Morris, K., Mackerness, S.A.-H., Page T., John, C.F., Murphy, A.M., Carr, J.P., and Buchanan-Wollaston, V., 2000. Salicylic acid has a role in regulating gene expression during leaf senescence. *Plant J.*, **23**:677-685.
- Pesci, L., 1987. ABA-induced proline accumulation in barley leaf segments: dependence on protein synthesis. *Physiol. Plant.*, **71**:287-291.

- Rademacher, W., and Grabe, J.E., 1984. Hormonal changes in developing kernels of two spring wheat differing in storage capacity. *Ber. Deutch. Bot. Ges.*, **97**:167-181.
- Ramagopal, S., 1987. Salinity stress induced tissue-specific proteins in barley seedlings. *Plant Physiol.*, **84**:324-331.
- Raskin, I., 1992. Role of salicylic acid in plants. *Annu. Rev. Plant Physiol. Plant Mol. Biol.*, **43**:439-463.
- Rock, C.D., 2000. Pathways to abscisic acid-regulated gene expression. *New Phytol.*, **148**:357-396.
- Sakamoto, A., Okumura, T., Kaminaka, H., Sumi, K., and Tanaka, K., 1995. Structure and differential response to abscisic acid of two promoters for the cytosolic copper/zinc-superoxide dismutase genes, SodCcl and Sod Cc2, in rice protoplasts. *FEBS Lett.*, **358**:62-66.
- Sakhabutdinova, A.R., Fatkhutdinova, D.R., and Shakirova, F.M., 2004. Effect of salicylic acid on the activity of antioxidant enzymes in wheat under conditions of salination. *Appl. Biochem. Microbiol.* **40**:501-505.
- Sedlarova, M., and Lebeda, A., 2001. Histochemical detection and role of phenolic compounds in the defense response of *Lactuca* spp. To lettuce downy mildew (*Bremia lactacae*). *J. Phytopathol.*, **149**:693-697.
- Senaratna, T., Touchell, D., Bunn, E., and Dixon, K., 2000. Acetyl salicylic acid (Aspirin) and salicylic acid induce multiple stress tolerance in bean and tomato plant. *Plant Growth Regul.*, **30**:157-161.
- Shadle, G.L., Wesley, S.V., Korth, K.L., Chen, F., Lamb, C., and Dixon, R.A., 2003. Phenylpropanoid compounds and disease resistance in transgenic tobacco with altered expression of L-phenylalanine ammonia-lyase. *Phytochem.*, **64**:153-161.
- Shakirova, F.M., Allagulova, Ch.R., Bezrukova, M.V., and Gimalov F.R., 2005. Induction of expression gene *TADHN* and accumulation of abscisic acid in wheat plants in hypothermia. *Dokl. Biochem. Biophys.*, **400**:69-71.
- Shakirova, F.M., and Bezrukova, M.V., 1997. Induction of wheat resistance against environmental salinization by salicylic acid. *Biol. Bull.*, **24**:109-112.
- Shakirova, F.M., Sakhabutdinova, A.R., Bezrukova, M.V., Fatkhutdinova, R.A., and Fatkhutdinova, D.R., 2003. Changes in the hormonal status of wheat seedlings induced by salicylic acid and salinity. *Plant Sci.*, **164**:317-322.
- Singh, B., and Usha, K., 2003. Salicylic acid induced physiological and biochemical changes in wheat seedlings under water stress. *Plant Growth Regul.*, **39**:137-141.
- Srivastava, M.K., and Dwivedi, U.N., 2000. Delayed ripening of banana fruit by salicylic acid. *Plant Sci.*, **158**:87-96.
- Tarchevskii, L.A., 2002. *Signal'nye sistemy kletok rastenii* (Signal Systems of Plant Cells). Moscow: Nauka, 294 p.
- Tasgin, E., Atici, O., and Nalbantoglu, B., 2003. Effects of salicylic acid and cold on freezing tolerance in winter wheat leaves. *Plant Growth Regul.*, **41**:231-236.
- Thulke, O., and Conrath, U., 1998. Salicylic acid has dual role in activation of defence-related genes in parsley. *Plant J.*, **14**:35-42.
- Uzunova, A.N., and Popova, L.P., 2000. Effect of salicylic acid on leaf anatomy and chloroplast ultrastructure of barley plants. *Photosynthetica*, **38**:243-250.
- Vuletic, M., Hadzi-Taskovic, V., and Vucinic, Z., 2003. Superoxide synthase and dismutase activity of plasma membranes from maize roots. *Protoplasma*, **221**:73-77.
- Ward, E.R., Uknes, S.J., Williams, S.C., Dincher, S.S., Wiederhold, D.I., Alexander, D.C., Ahl-Goy, P., Metraux, J. P., and Ryals, J. A., 1991. Coordinate gene activity in response to agents that induce systemic acquired resistance. *Plant Cell*, **3**:1085-1092.

- Wu G., Wilen R.W., Robertson A.J., and Gusta L.V., 1999. Isolation, chromosomal localization, and differential expression of mitochondrial manganese superoxide dismutase and chloroplastic copper/zinc superoxide dismutase genes in wheat. *Plant Physiol.*, **120**:513-520.
- Zenkov, N.K., Lankin V.E., and Menshchikova, E.V., 2001. *Okislitel'nyi stress* (Oxidative Stress). Moscow: Nauka, 280 p.
- Zholkevich V.N., and Pustovoytova T.N., 1993. The role of *Cucumis sativum* L leaves and content phytohormones under soil drought. *Russian J. Plant Physiol.*, **40**:676-680

Chapter 5

ROLE OF SALICYLIC ACID IN THE INDUCTION OF ABIOTIC STRESS TOLERANCE

T. JANDA, E. HORVÁTH, G. SZALAI AND E. PÁLDI

*Agricultural Research Institute of the Hungarian Academy of Sciences, H-2462, Martonvásár,
POB. 19. HUNGARY*

Abstract: Investigations on compounds capable of reducing the stress sensitivity of crops are of great importance from both the theoretical and the practical point of view. In terms of stress physiology, salicylic acid was first demonstrated to play a role in responses to biotic stress. However, it was gradually found to have more and more effects that could be of importance for other stress factors, and a great deal of evidence has accumulated in recent years suggesting that salicylic acid also plays a role in responses to abiotic stress effects (such as low and high temperature, UV-B irradiation, ozone, heavy metals, etc.). Most papers, on this subject, have reported on the protective effect of exogenous salicylic acid against abiotic stress. When applied in satisfactory concentrations salicylic acid may cause a temporary low level of oxidative stress in plants, which acts as a hardening process, improving the antioxidative capacity of the plants and helping to induce the synthesis of protective compounds such as polyamines. Numerous mutant or transgenic plants are now available in which the salicylic acid metabolism has been modified in some way. These allow us to obtain a more accurate picture of the endogenous effect and role of salicylic acid. Evidence now suggests the existence of a regulatory defence mechanism in which salicylic acid plays an important role, but which is not stress-specific, apparently functioning against many different stress factors. This chapter provides a review of the effects exerted by salicylic acid and related compounds in relation to abiotic stress tolerance.

Key words: Abiotic stresses, oxidative stress, salicylic acid, signal transduction.

1. INTRODUCTION

The name of salicylic acid (SA) is derived from the word *Salix*, the scientific name of the willow tree. Both the American Indians and the ancient Greeks knew that the leaves and bark of willow trees could be used as a painkiller and antipyretic (one has the feeling that they discovered everything, but their knowledge lost and we have to start again from the beginning). Salicilin, the glucoside of salicylic alcohol, was isolated from willow bark in 1828. Acetyl SA, commercially known as aspirin, is one of the best known “antistress compounds” used by human beings.

SA is generally present in plants in quantities of a few $\mu\text{g/g}$ fresh mass or less (Raskin *et al.*, 1990), either in a free state or in the form of glycosylated, methylated, glucose-ester or amino acid conjugates (Lee *et al.*, 1995). It can be detected in the largest quantities in thermogenic flowers at flowering, or after pathogenic infection (Raskin, 1992). The biosynthesis of SA starts from phenylalanine and follows one of two known paths of synthesis, one of which involves trans-cinnamic acid and the hydroxylation of benzoic acid (BA). Feeding tobacco leaf tissue with putative precursors showed that only BA was capable of increasing tissue levels of SA, suggesting that BA is a direct precursor of SA in tobacco (Raskin, 1995). However, later results indicated that benzoyl glucose, a conjugated form of BA, is more likely to be the direct precursor (Yalpani *et al.*, 1993; Chong *et al.*, 2001). The cinnamic acid-derived synthesis of SA also takes place in cucumber, potato and rice. The other possible pathway is the formation of ortho-coumaric acid (ortho-hydroxy-cinnamic acid; oHCA) from trans-cinnamic acid, followed by a chain-shortening reaction leading to SA. The latest results show that higher plants may produce pathogen-induced SA from isochlorismate, a biosynthetic pathway typical of bacteria (Wildermuth *et al.*, 2001).

The first plant physiological processes in which SA was reported to play a role were growth regulation (DeKock *et al.*, 1974) and flower induction, which was demonstrated in a long-day *Lemna gibba* L. strain (Cleland, 1974; Cleland and Ajami, 1974). Since then both endogenous and exogenous SA have been shown to have various effects (Raskin, 1992), but these cannot always be generalised, as the studies were carried out on various plant species in various systems (from the whole plant to cell suspensions). It has been demonstrated that SA and other phenolic compounds may influence the uptake of numerous ions. In the case of barley the uptake of phosphate (Glass, 1973) and potassium ions (Glass, 1974a) was inhibited in the presence of SA, probably due to the depolarisation of cell membranes (Glass, 1974b). There was a substantial decrease in transpiration in bean leaves after treatment with 1 or 10 mM SA (Larque-Saavedra, 1978, 1979). It has been demonstrated that SA and related compounds are capable of

inhibiting the abscisic acid (ABA) induced stomatal closure (Rai *et al.*, 1986). Long-term SA treatment was observed to reduce the quantity of the Rubisco enzyme in barley plants, thus inhibiting photosynthetic activity (Pancheva and Popova, 1998). When wheat plants were treated with SA for seven days, it was found that, while low (0.05 mM) concentrations of SA promoted photosynthesis, higher quantities (0.5–1.0 mM) inhibited photosynthetic activity, principally due to the inhibition of PSI electron transport and to a reduction in the level of cytochrome f_{554} . No effect was observed, however, when isolated thylakoids were treated with SA (Sahu *et al.*, 2002).

SA was able to stimulate the adventitious root primordia of bean plants (Kling and Meyer, 1983), while in maize shoots the *in vivo* nitrate reductase activity was found to increase after treatment with 0.01–0.1 mM SA (Jain and Srivastava, 1981). It is probable, however, that this increase in activity is an indirect effect arising from the inhibition of enzyme inactivation. Another well-known effect of SA is that it increases the temperature of certain thermogenic plants. The production of heat by plants was first described by Lamarck in 1778 in a study on *Arum* species, but since then many cases have been reported, mainly in members of the Annonaceae, Araceae, Aristolochiaceae, Cyclanthaceae, Nymphyaceae and Palmae families (Meeuse and Raskin, 1988). In some flowering *Arum* species, the oxygen uptake when heat production is most intense may be as great as the oxygen consumption of a flying hummingbird (Lance, 1972). Heat production in these species serves principally to aid the exudation of perfumes. During certain parts of the flowering period the temperature of the flower may rise by as much as 12°C. It was demonstrated in the species *Sauromatum guttatum* S. that the calorigenic substance responsible for the induction of heat production was identical to SA (Raskin *et al.*, 1987). Evidence was found to show that the increase in alternative oxidase expression as the result of SA played a role in the induction of thermogenesis (Rhoads and McIntosh, 1992). However, SA was also shown not only to induce cyanide-resistant respiration but also to block electron flow from the substrate dehydrogenases to the ubiquinone pool in isolated mitochondria, and acted as an uncoupler of the mitochondrial electron transport chain (Norman *et al.*, 2004).

The role of SA in the signal transduction processes of biotic stress tolerance has already been widely studied. It is involved in the development of the hypersensitive reaction (HR): in tobacco leaves infected with tobacco mosaic virus and there is an increase in the level of endogenous SA in the necrotic lesion and surrounding tissues (Enyedi *et al.*, 1992). The external application of SA induces the expression of pathogenesis-related (PR) proteins in tobacco (Malamy *et al.*, 1990; Yalpani *et al.*, 1991) and in rice

(Rakwal *et al.*, 2001). A large body of evidence indicates that SA is also required for the development of systemic acquired resistance (SAR). The level of endogenous SA increased in cucumber plants when acquired resistance developed (Métraux *et al.*, 1990). Transgenic tobacco plants, incapable of accumulating SA due to the presence of a salicylate-hydroxylase enzyme gene (*NahG*) of bacterial origin, were unable to develop systemic acquired resistance (Gaffney *et al.*, 1993). Nevertheless, SA does not appear to be the signal molecule transported from the site of infection to more distant tissues, though the accumulation of SA in the given tissues is essential if SAR is to develop (Vernooij *et al.*, 1994).

There is an increasing body of evidence suggesting that SA is involved not only in biotic stress, but also in abiotic stress. Most work has been done on the protective effect of exogenously applied SA. A summary will be given in the next chapter of the relationship between SA and various abiotic stress factors, followed by a summary of the known physiological and biochemical effects of SA that may explain the change in stress tolerance.

2. STUDIES ON THE EFFECT OF EXOGENOUS SALICYLIC ACID

2.1 Toxic metals

Heavy metal ions play an important role in many metabolic processes, making them essential in trace element quantities for the metabolism, growth and development. Heavy metals are only able to exert any stimulatory or inhibitory effect on plants if they are present in a form available to the plants. Availability is influenced by a range of abiotic and biotic factors. The abiotic factors include the ionogenicity of the toxic metal, its solubility in water, and its ability to form complexes, and the pH and redox potential of the soil. The biotic parameters include the protons and organic acids (e.g. citric acid, amino acids) exuded into the rhizosphere from plant roots, the symbiosis of higher plants with mycorrhizal fungi, and the quantity of humic acids and humin present in the soil as a result of organic matter decomposition. Problems only arise when the cells encounter a higher concentration of heavy metal ions, which cause cell damage. One aspect of heavy metal toxicity is the inactivation of biomolecules, either through the blockage of functional groups or through the exchange of vital ions. A further source of danger is the autooxidation of the heavy metals and the formation of reactive oxygen species (ROS), which may also damage the cells due to the Fenton reaction.

Both plants in natural ecosystems and cultivated crops can be divided into two major groups, based on the ability or inability of the plants to adapt to heavy metal ions. In plants, sensitive to heavy metals and unable to adapt, cell damage, or in severe cases cell death, may be caused by a number of mechanisms: i) certain heavy metal ions, readily exchanged, for the essential metal ions in the active centre of enzymes (e.g. Mg^{2+} , Zn^{2+} , Cu^{2+} , Co^{2+}), thus inhibiting the regulatory role of the enzymes, ii) they may prevent the maturation of nucleic acids by inhibiting the splicing process, iii) heavy metal ions may form free radicals, leading to the lipid peroxidation of cell membranes thus cause them to lose their ion permeability. Plant species tolerant of heavy metal ions have various mechanisms to ensure their survival. These include the inhibition of metal ion uptake, biochemical or enzymatic modifications of the root surface, the binding of metal ions to cell wall sections, the transportation of metal complexes to the vacuoles for storage, the formation of less toxic compounds by means of methylation, and the excretion or secretion of heavy metal ions. Some of the most important compounds involved in heavy metal tolerance are metal-binding proteins and phytochelatins. The former are cysteine-rich, low-molecular-mass proteins, found mostly in animals, capable of neutralising toxic heavy metal ions by forming mercaptide complexes, while the latter are peptides occurring in plants and yeasts and contain glutamic acid in a γ -bond, allowing them to form thiolate bonds with heavy metal ions and thus protect plant cells from damage. Phytochelatins are important not only due to their metal-binding capacity, but also because they transport the bound metal ions from the cytoplasm into the vacuoles, where they can be stored as non-toxic form, bound to organic acid ligands.

One of the earliest works to report on the protective effect of SA against abiotic stress factors, dealt with heavy metals. SA application at a concentration of 0.1 or 0.2 mM reduced the inhibitory effect of Pb^{2+} and Hg^{2+} on the seed germination and seedling growth of two rice (*Oryza sativa* L.) cultivars (Mishra and Choudhuri, 1997). SA increased the fresh and dry mass of shoots and roots in both cultivars under heavy metal stress conditions. The higher concentration of SA was more effective, as evident from a better recovery from metal-induced growth inhibition. SA moderated the inhibitory effect of lead on the activity of the nitrate reductase enzyme in maize (*Zea mays* L.) plants (Sinha *et al.*, 1994). SA-induced aluminium tolerance was also reported in *Cassia tora* L. plants, while Al increased the SA concentration in the roots (Yang *et al.*, 2003). Increased citrate efflux due to the SA treatment was associated with decreased inhibition of root growth and of Al content in the root tips. The results suggest that exogenous SA was able to confer Al tolerance by increasing the citrate efflux, not by increasing the citrate synthase activity and citrate concentration in the root

tips, which remained unaffected by the treatment (Yang *et al.*, 2003). This suggests that SA has some role in the tolerance of plants to heavy metal stress, though other authors found no increase in the endogenous SA content as the result of Cd treatment, or any difference in the SA content of sensitive and resistant plants of *Salix viminalis* in the control (Landberg and Greger, 2002).

The preliminary treatment of barley plants with SA was found to prevent the lipid peroxidation induced by 25 μ M cadmium, thus increasing the fresh shoot and root mass. However, this protective effect was not due to an increase in the antioxidant capacity. The increased activity of antioxidant enzymes observed in untreated plants during cadmium stress could not be detected in plants, preliminarily treated with SA (Metwally *et al.*, 2003). Other results indicate that, although SA reduced the cadmium uptake of the roots, the compound itself stressed the plants; so preliminary treatment with SA could aggravate the damaging effect of cadmium (Pál *et al.*, 2002). At the same time, the endogenous SA content exhibited a concentration-dependent increase in maize plants, treated with cadmium (Pál *et al.*, 2005). Higher cadmium concentrations (0.025 mM or more) triggered an approximately 3-fold accumulation of free and conjugated BA and SA, with a higher amount in the bound form. However, the accumulation was not of the same magnitude for SA and BA. The accumulation of conjugated forms of BA indicates the rapid conversion of free forms to conjugated forms. The large-scale accumulation of bound BA can also be explained by the lower rate of SA biosynthesis. The accumulation of free and bound oHCA was also observed in Cd-treated leaves. Among the phenolic compounds the highest accumulation was found in the case of bound oHCA in the leaves. Since oHCA has been demonstrated to have antioxidant properties (Foley *et al.*, 1999), these results, therefore, suggest that the increase in the oHCA content was induced independently of the SA biosynthesis, but may play a role in the antioxidative response to cadmium. The increased endogenous SA levels in the leaves of maize seedlings may be associated with the oxidative stress observed in the leaves of Cd-stressed plants, suggesting a role for SA in the response of maize to cadmium.

Worldwide, several hundreds plant species are now known to hyperaccumulate various trace elements, including heavy metals in their shoots when growing in their native habitats (Freeman *et al.*, 2005). The extraordinary ability of these plants to hyperaccumulate Ni/Zn makes them an ideal source of genetic material for the development of both mineral nutrient-fortified crops and plants suitable for the phytoremediation of metal-polluted soils and waters (Guerinot and Salt, 2001). Heavy metal tolerance is often correlated with intracellular compartmentization (Brune *et al.*, 1995). Nickel hyperaccumulation is usually due to a highly efficient

pumping system that transfers the metal to the central vacuole of the shoot cells, leading to a high level of tolerance to this element (Krämer *et al.*, 2000). It is clear from cellular Ni distribution studies (Krämer *et al.*, 2000), that a substantial amount of cellular Ni also accumulates outside the vacuole, suggesting the need for a cytoplasmic-based tolerance mechanism. Nicotianamine may also play an important role in the detoxification of extracellular Ni in hyperaccumulating plants (Vacchina *et al.*, 2003). Due to the constitutively enhanced activity of serine acetyltransferase, glutathione concentrations in *Thlaspi* hyperaccumulators are also constitutively elevated, leading to enhanced tolerance to Ni-induced oxidative stress (Freeman *et al.*, 2004). In a later experiment, it was also proved that the glutathione-mediated Ni tolerance mechanism observed in Ni-hyperaccumulating *Thlaspi* species is signalled by the constitutively elevated levels of SA. It was also observed that both biochemical and genetic manipulations that increase SA in *Arabidopsis thaliana* (L.) Heynh plants mimic the glutathione-related phenotypes of the hyperaccumulating *Thlaspi*, and that these biochemical changes in the non-accumulator are associated with increased glutathione-mediated Ni resistance. Such observations suggest that SA may be one of the regulators involved in coordinating certain key biochemical differences between Ni/Zn hyperaccumulators and non-accumulator plant species.

2.2 Drought

Plants are exposed to drought stress when there is not sufficient water available, or when, for some other reason, the water present cannot be taken up by the plants, e.g. if the ground is dry, if there is intense evaporation or severe frost, or if the soil has a high salt content, leading to strong osmotic water-binding. The first, most sensitive sign of water deficiency is a reduction in turgor, leading to the retardation of growth processes, especially lengthwise growth. Drought stress also reduces photosynthesis, for a number of reasons: i) hydroactive stomatal closure reduces the CO₂ supply to the leaves, ii) water deficiency damages the cytoplasm ultrastructure and enzyme activity, iii) dehydrated cuticles, cell walls and plasma membranes are less permeable to CO₂. An analysis of the correlation between drought and the carbohydrate metabolism reveals that one characteristic symptom of water deficiency is the mobilisation of the starch stored in the chloroplasts. As there is also a reduction in the translocation of carbohydrates during drought stress, this leads to a change in source-sink relationships.

Although ion uptake and water uptake are not closely related, water deficiency has also been found to jeopardise nutrient uptake. This can be attributed to the fact that when the soil moisture content is low, there is a

reduction in water migration and thus in the quantity of ions transported by the water. A further difficulty arises due to the retardation of root growth in dry soil, with a consequent reduction in ion uptake. The negative effect of drought stress is first felt in the uptake of phosphorus from the upper soil layers. Water deficiency also has a major effect on the nitrogen metabolism. There is a considerable decline in protein synthesis in water-deficient plants, due to the reduced number of polysome complexes in tissues with a lower water content. Another noticeable change is the decline in nitrate reductase activity. Parallel with the drop in water potential, there is a reduction in the intensity of transpiration and in the quantity of nitrate transported by water flow, in the xylem, resulting in lower nitrate content and nitrate reductase activity in the leaves. Another characteristic symptom of drought stress is the formation and accumulation of ABA. The biosynthesis of this stress hormone is induced by the turgor reduction, arising due to water loss. ABA-dependent and ABA-independent signal transduction chains have been shown to function between the primary signal, induced by drought or cold stress and the expression of specific genes. One pathway of ABA-dependent signal transduction systems requires protein synthesis, while the other does not. The regulation of one ABA-independent pathway, on the other hand, involves a dehydration responsive element in the case of both drought and salt- or cold-induced stress, while the other pathway is only initiated by drought or salt stress. The genes induced by dehydration also control the genes responsible for the signal transduction pathway of the response to drought stress. One group contains proteins involved in stress tolerance (e.g. water channel proteins, proteins protecting macromolecules and membranes, such as LEA proteins or chaperones), while the other contains proteins, participating in signal transduction and gene expression (e.g. protein kinases, transcription factors, phospholipase C).

When wheat seeds were soaked in acetyl SA (which may be degraded into SA in aqueous solution) the plants had better resistance to drought stress (Hamada, 1998; Hamada and Al-Hakimi, 2001). Soaking in 100 ppm acetyl SA for 6 h, before sowing not only allevated the inhibitory effects of drought but also had a stimulatory effect, as both the dry matter gain in the shoots and roots and the transpiration rate showed a marked increase. Treatment with ascorbic acid or thiamine had a similar protective effect, which was attributed to the protection of the photosynthetic apparatus from oxidation and the retardation of dark respiration (Hamada, 1998). In another experiment, irrespective of the SA concentration (1-3 mM) and the level of water stress, plants treated with SA generally exhibited higher moisture content, dry mass, carboxylase activity of Rubisco, superoxide dismutase (SOD) activity and total chlorophyll, compared to untreated seedlings (Singh and Usha, 2003). In the case of water stress, SA treatment protected nitrate

reductase activity and maintained the protein and nitrogen contents of the leaves, compared to water-sufficient seedlings. The results signify the role of SA in regulating the drought response of plants and suggest that SA could be used as a potential growth regulator to improve plant growth, under water stress.

Both SA and acetyl SA proved effective in protecting tomato and bean plants against drought stress at concentrations of 0.1 mM and 0.5 mM. Above and below this concentration range, however, no positive results were recorded (Senaratna *et al.*, 2000). It is interesting to note that protection was afforded by SA or aspirin against not only drought, but also against low and high temperature stress, irrespective of whether the seeds were soaked for 1 day, or whether two-week-old plants were treated, either through the soil or in the form of spraying. Among several other plant growth substances, for example brassinolide, methyl jasmonic acid (methyl JA), ABA, 1-aminocyclopropane-1-carboxylic acid (ACC), 2-chloro-ethylphosphonic acid (ethephon), gibberellic acid and kinetin (but not indoleacetic acid or zeatin), SA also improved the protoplasmic drought tolerance of free-cell suspensions prepared from fully turgid leaves of *Sporobolus stapfianus* (Ghasempour *et al.*, 2001). In maize, however, although a 1-day preliminary treatment with 0.5 mM SA increased the polyamine content of the plants, drought tolerance was not improved; in fact, plants treated in this way became more susceptible to drought (Németh *et al.*, 2002). A negative effect was also recorded when wheat plants were treated in this way, suggesting that the effect of SA is influenced by the method of treatment and by the developmental stage of the plant.

The SA level in leaves of *Phillyrea angustifolia* L. plants exposed to drought showed a strong negative correlation with the relative water content, and increased progressively to as much as 5-fold during drought (Munne-Bosch and Penuelas, 2003). During recovery, SA levels decreased, but remained slightly higher than those observed before drought. SA levels were positively correlated with those of α -tocopherol during drought, but not during recovery. This result also indicates the possible role of endogenous SA in the induction of a protective mechanism during water stress.

In another experiment the effect of moderate or severe water deficit on the SA content in the leaves and roots, and the effect of pre-treatment with SA on the response to water stress were evaluated in barley plants (Bandurska and Stroinski, 2005). Water deficit increased the SA content in the roots, whereas the SA content in the leaves did not change. Plant treatment with SA before stress reduced the damaging effect of water deficit on the cell membrane in the leaves. SA treatment increased the ABA content in the leaves of the studied genotypes. An increase in the proline level was observed only in the wild species *Hordeum spontaneum*. The results suggest

that ABA and proline may contribute to the development of the antistress reactions, induced by SA.

2.3 Heat tolerance

Plants growing in cold regions of the world are much more sensitive to heat than those from the temperate zone, which again are less resistant to heat than those indigenous in the tropics. Heat-sensitive species suffer damage at temperatures of 30–40°C, while heat-tolerant plants are capable of hardening and can tolerate 50°C for a considerable length of time. One common defence against overheating is transpirational cooling, which is only possible if sufficient water is available. The primary effect of high temperature is to alter protein conformations and membrane status. In plants, as in other living organisms, the synthesis of most proteins slows down at temperatures well above optimum, and may cease altogether if the temperature continues to rise. At the same time, the transcription and translocation of heat shock proteins (HSPs) is stimulated. Heat shock proteins belong to multigene families, most of which are regulated by high temperature, while a small number are induced by other abiotic stress factors. Proteins known as chaperones are responsible for the secondary and tertiary structure of the polypeptides synthesised in the cell, for linking up the subunits and for transporting them to the required cell component. If this complex process is disturbed, for example by high temperature, newly synthesised proteins form insoluble aggregates. It is currently thought that the majority of stress proteins are molecular chaperones, most of which have been identified as HSPs. The thylakoid membranes of the chloroplasts are the most important for heat sensitivity, so one critical aspect of heat tolerance in plants is the continual maintenance of photosynthesis. Consequently, one of the first signs of high temperature stress is a reduction in photosynthetic activity. Recent research has proved that many HSPs are transported into the chloroplasts, where they promote the heat tolerance of the photosynthetic system.

The capacity to survive heat shock varies with the plant species and genotype, and also with the developmental stage. Plants may have basal thermotolerance in the absence of pre-adaptation. In addition, plants subjected to mild heat stress may transiently acquire tolerance to previously lethal high temperatures: this phenomenon is known as acquired thermotolerance or heat acclimatisation, and is probably an adaptation to the gradual increases in temperature in the natural environment (Clarke *et al.*, 2004).

The first paper to demonstrate the effect of SA on heat tolerance showed that spraying with SA improved the heat tolerance of mustard plants and that

this effect was concentration-dependent: SA only exhibited a protective effect at low concentrations (0.01–0.1 mM). Both, treatment with 0.01 mM SA and hardening at 45°C for 1 h led to an increase in the H₂O₂ level and a reduction in catalase activity (Dat *et al.*, 1998a). The role of SA in the signal transduction process of heat tolerance development is also confirmed by the increase in the level of endogenous bound and free SA during the heat acclimatisation of mustard plants (Dat *et al.*, 1998b). When tobacco was grown *in vitro* for 4 weeks on medium containing SA, low concentrations (0.01 mM) were found to increase heat tolerance, while a concentration of 0.1 mM no longer had any protective effect (Dat *et al.*, 2000). The endogenous glucosylated SA content was enhanced in the shoots of plants grown on 0.01 or 0.1 mM SA, while free SA was also enhanced in those grown on 0.1 mM SA. The shoot H₂O₂ content increased, while the catalase activity declined as the SA concentration in the medium increased. In a similar manner, 0.01 mM acetyl SA was able to improve the heat tolerance of potato in tissue culture, while there was an increase in the endogenous H₂O₂ level in the plants (Lopez-Delgado *et al.*, 1998, 2004). It was also shown that potato microplants grown from explants incubated for 1 h in 0.1–50 mM H₂O₂ exhibited a concentration-dependent decrease in stem height, but were significantly more thermotolerant than the controls, even more than a month after the H₂O₂ treatment, showing that not only SA but also H₂O₂ is able to increase the heat tolerance of potato plants. SA treatment was also found to reduce the oxidative damage caused by heat stress in *Arabidopsis* plants. In addition to SA, ethylene, ABA and calcium have also been shown to play a role in the development of tolerance to high temperatures (Larkindale and Knight, 2002).

The efficacy of heat acclimation and SA treatment applied as a 0.1 mM foliar spray in inducing thermotolerance was also tested in *Cicer arietinum* L. plants (Chakraborty and Tongden, 2005). A substantial reduction in the relative level of membrane injury was observed in plants pre-treated with SA in comparison to heat-acclimatized and untreated control seedlings subjected to lethal temperature treatment. Both treatments resulted in an increase in the protein and proline contents over the control seedlings, and led to the induction of peroxidase and ascorbate peroxidase (Apx), while there was a reduction in catalase activity.

Turf quality often declines during summer when temperatures exceed the optimum range. Physiological measurements, including turf quality, leaf photosynthetic rate and levels of oxidative damage demonstrated that among several other signaling compounds, such as ABA, CaCl₂, H₂O₂ or ACC, the foliar application of SA increased the heat tolerance of creeping bent-grass (*Agrostis stolonifera* var. *palustris*). The better heat tolerance of pre-treated plants as compared to the control was related to the protection from

oxidative damage under heat stress: although SA pre-treatment had no effect on peroxidase activity and the catalase activity was lower than in the control plants, it increased the APx activity (Larkindale and Huang, 2004). In another experiment involving SA concentrations from 0 to 1.5 mM, 0.25 mM most effectively enhanced heat tolerance in Kentucky bluegrass (*Poa pratensis* L.), which was manifested by improved re-growth potential following heat stress at 46°C for 72 h and the maintenance of leaf water content. Contrary to the results obtained in mustard, potato or creeping bentgrass species, increased SOD and catalase activities were observed under heat stress after SA application in Kentucky bluegrass (He *et al.*, 2005). A primary economic concern of sod producers is the loss of sod quality during the transportation and storage phases of a sale. Unfortunately, even when proper cultural guidelines are followed, excessive sod heating and tissue damage often occurs. The foliar application of 0.5 kg ha⁻¹ SA enhanced the photochemical efficiency of the pre-harvest canopy in both Kentucky bluegrass and tall fescue (*Festuca arandinacea* Schreb.) sod (Ervin *et al.*, 2005). SA also reduced visual injury and enhanced post-harvest root strength, suggesting that pre-harvest foliar SA application may improve the shelf life and transplant success of supraoptimally heated cool-season sod.

Another type of study investigates the effect of a lack of SA in transgenic plants or in plants with a mutation affecting SA biosynthesis. *NahG* transgenic plants carry a salicylate-hydroxylase gene of bacterial (*Pseudomonas putida*) origin, which prevents them from accumulating SA, as the salicylate-hydroxylase enzyme converts SA into catechol (Gaffney *et al.*, 1993). It was found that after heat stress *NahG Arabidopsis* plants became more sensitive to oxidative damage caused by high temperature than non-transformed plants with a normal level of SA. Furthermore, exogenous SA pre-treatment for 1 h enhanced survival and reduced the level of thiobarbituric acid-reactive substances (TBARS), the indicator of oxidative damage to membranes, in *Arabidopsis* plants after a 40°C heat treatment (Larkindale and Knight 2002). However, it has recently been shown that catechol, the product of SA degradation in *NahG* plants, induces susceptibility to pathogens in wild-type *Arabidopsis* plants, most probably due to catechol-mediated H₂O₂ production (van Wees and Glazebrook 2003). It is thus important to check, when evaluating the experiments, that the observed changes were not caused by the catechol produced during the decomposition of SA.

To investigate the importance of different processes in the development of heat stress tolerance, *Arabidopsis* mutants and one transgenic line were tested for basal and acquired thermotolerance at different stages of growth (Larkindale *et al.*, 2005). The plants tested either had defective signalling pathways (ABA, SA, ethylene, and oxidative burst signalling) or reactive

oxygen metabolism (ascorbic acid or glutathione production, catalase), or had previously been found to have temperature-related phenotypes (e.g. fatty acid desaturase mutants, the UV-sensitive mutant, *uvh6*). The mutants were assessed for thermotolerance defects in seed germination, hypocotyl elongation, root growth and seedling survival. To assess oxidative damage and alterations in the heat shock response, TBARS, HSP 101, and small HSP levels were determined. ABA signalling mutants and *uvh6* showed the strongest defects in acquired thermotolerance of root growth and seedling survival. Mutations in NADP oxidase homologue genes, ABA biosynthesis mutants and *NahG* transgenic lines showed weaker defects. Ethylene signalling mutants and reactive oxygen metabolism mutants were more defective in basal than acquired thermotolerance, especially under high light. All the mutants accumulated wild-type levels of HSP 101 and small HSP. These data indicate that, apart from HSP induction, ABA, active oxygen species and SA pathways are involved in acquired thermotolerance and that UVH6 plays a significant role in temperature responses, in addition to its role in UV stress.

However, it was shown, using *Arabidopsis* genotypes with modified SA signalling that SA-dependent signalling plays a role in the maintenance of basal thermotolerance: 0.5 or 1 mM SA pre-treatment promotes basal thermotolerance in 3-week-old *Arabidopsis* plants, together with the induction of PR proteins, demonstrated by the less pronounced electrolyte leakage from the leaves after heat stress (Clarke *et al.*, 2004). The level of endogenous SA correlated with basal thermotolerance. Recovery from heat shock apparently involved an NPR1-dependent pathway but thermotolerance during heat shock did not. It was also shown that SA is not essential for acquired thermotolerance: all the genotypes could be heat acclimated, irrespective of their endogenous SA content. It may be that SA is dispensable because heat acclimation is always initiated by some other key factor(s), or because SA is only one of multiple alternative acclimation signals. If SA were a potential mediator of a heat-induced acclimation response, SA levels should be heat-inducible. A moderate, transient, but statistically significant increase in glucosylated SA during heat treatment was also shown in wild-type *Arabidopsis* plants. Given the significant basal levels of SA in *Arabidopsis* and mustard, the extent to which such changes in the SA metabolism provide additional thermotolerance is uncertain, but they suggest that despite the metabolic stress of heat treatment, the plant actively maintains biosynthesis of this hormone. In plants, SA is subject to glucosylation, which might be involved in transport (Seo *et al.*, 1995a) or vacuolar localization (Dean *et al.*, 2003). Heat-induced SA increases were not apparent in the other *Arabidopsis* genotypes, although this might be because of their altered SA metabolism or signalling (Clarke *et al.*, 2004).

2.4 Cold stress

Temperature is one of the major determinants of the occurrence and spread of natural plant associations. For crops, too, low temperature is one of the most important factors restricting cultivation in a given area. Plants are said to be cold-sensitive if they die or suffer severe damage at temperatures between 0 and 15°C. Cold-tolerant plants, on the other hand, are still able to grow near freezing point and are capable of surviving temperatures as low as 10–15°C below zero. Apart from genetic factors, cold sensitivity also depends on the stage of development and the level of metabolic activity. Plants are more sensitive to cold in the early phases of development, during the day, in bright light, under dry conditions and in the case of potassium deficiency, for example. Results achieved so far suggest that differences in membrane composition make a substantial contribution to sensitivity to low temperature stress. The quantity of unsaturated fatty acids has been shown to be much lower in cold-sensitive plants than in those tolerant of low temperatures. The duration and intensity of the cold effect is also an important factor. If the plant is only exposed to cold for a short period, the process is reversible and no serious damage is incurred. If, however, the cold is severe or continues for a long period, cell damage is accelerated and the process becomes irreversible. The rate at which cooling takes place also has a considerable influence. If cooling is slow, the hardening process prepares the plant to survive frost and winter weather. This is of great importance in winter cereals, for example. Sudden frost stress is a more severe form of low temperature stress, which causes the membranes to lose their semipermeability and thus their active ion transporting ability. The phospholipids begin to decompose, a phase transition occurs and the distribution of the membrane proteins changes. The greatest danger is the formation of ice crystals within the cells. Plants growing in areas exposed to long-term cold survive either by avoiding temperatures below the freezing point or by tolerating freezing. The most important way of avoiding freezing is the accumulation of osmolytes induced by low temperature (sugars, polyalcohols, amino acids, polyamines, quaternary ammonium compounds, etc.), which cause the freezing point within the cell to drop. This process prevents the dehydration of the cytoplasm as the result of frost. Plants such as perennials and conifers tolerate frost through extracellular ice formation in the apoplasts, where it does not have the lethal consequences it would have within the cell. Recent research has proved that the antifreeze proteins demonstrated in many plant species are capable of protecting the cell by preventing the formation of large crystals.

SA and other phenol derivatives are known to improve the cold tolerance of plants. It was shown that the addition of 0.5 mM SA to the hydroponic

growth solution of young maize plants under normal growth conditions provided protection against subsequent low-temperature stress. Besides the obvious visual symptoms this observation was confirmed by chlorophyll fluorescence parameters and electrolyte leakage measurements from the leaves (Janda *et al.*, 1997, 1999). Among the antioxidant enzymes, the activity of catalase decreased, while that of glutathione reductase and guaiacol peroxidase increased as a result of the preliminary treatment with SA. These changes might explain the increased cold tolerance. Since it was earlier shown that the chilling-induced level of ACC, the precursor of ethylene, is negatively correlated with the cold tolerance of maize plants (Janowiak and Dörffling, 1996), an investigation was also made on changes in ACC and malonyl ACC (MACC) after chilling stress. Chilling at 5°C caused an increase in ACC content; however, this increase was less pronounced in cold-acclimated plants, and in those which were pre-treated with SA for 1 d, before cold stress. Changes in MACC at low temperature showed no correlation with chilling tolerance in maize (Szalai *et al.*, 2000). Further studies proved that not only SA, but also related compounds, such as BA, aspirin or coumaric acid, may have a protective role against chilling stress in young maize plants (Janda *et al.*, 1998, 2000; Horváth *et al.*, 2002). It should be mentioned, however, that these compounds may cause severe damage to plants at normal growth temperature. There is a decrease in net photosynthesis, stomatal conductivity and transpiration after 1 day of SA, BA or aspirin treatment under normal growth conditions (Janda *et al.*, 1998, 2000). These compounds may cause a decrease in the growth rate in young, developing maize seedlings. In contrast to this, the foliar application of SA or aspirin enhanced photosynthetic rates in both soybean and maize (Khan *et al.*, 2003). Stomatal conductance and transpiration were also increased. Other stimulating effects of SA were reported in embryogenic cell suspension cultures of *Coffea arabica* treated with picomolar concentrations of SA (Quiroz-Figueroa *et al.*, 2001).

In a later work, the chilling tolerance of leaves or hypocotyls was significantly increased by the application of 0.5 mM SA not only in maize, but also in cucumber and rice (Kang and Saltveit 2002). This was manifested as a reduction in the chilling-induced electrolyte leakage from excised maize and rice leaf discs, and from excised cucumber hypocotyl segments in plants pre-treated with SA. However, SA treatment did not significantly alter the electrolyte leakage from radicles excised from any of the chilled seedlings. Obviously, exposure to SA was a severe shock to the seedlings even at concentrations as low as 0.5 mM, as indicated by the significant reduction in subsequent radicle growth. Other studies confirmed that the addition of exogenous SA to the hydroponic solution may cause severe damage to the roots (Pál *et al.*, 2002). This severe inhibitory effect on subsequent radicle

growth was observed when the seedlings were exposed to SA solutions after being inhibited in water and growth on capillary cloth, moistened with water. By contrast, exposure to aerated aqueous SA solutions during imbibition and growth did not significantly affect the rate of radicle growth at 25°C in cucumber seedlings. It is assumed that seedlings exposed to SA from germination may become acclimated to SA and did not perceive it as a stress or stress signal (Kang and Saltveit, 2002).

Pre-treatment of the leaves of chilling-sensitive banana seedlings with 0.5 mM SA solution by spraying the foliage or irrigating the roots for 1 day, induced an increase in chilling tolerance during subsequent 5°C chilling stress (Kang *et al.*, 2003a). These treatments did not result in any great change in the SOD activity, but reduced the catalase and APx activity, and increased the peroxidase activity. However, SA pre-treatment caused an activation of SOD, catalase and APx activities during a period of 5°C chilling stress, while it did not change the peroxidase activity. These effects of SA on activities of various protective enzyme could be associated with H₂O₂ metabolism. Measurement of H₂O₂ levels indicated that SA pre-treatment at 30/22°C resulted in H₂O₂ accumulation; however, it reduced H₂O₂ overproduction during the subsequent 5°C chilling stress. These results suggested that the H₂O₂ metabolism might also be involved in the enhanced chilling tolerance, induced by SA in banana plants (Kang *et al.*, 2003b).

Pre-soaking seeds before sowing could also be an effective way of improving cold tolerance. In tomato and bean plants, 0.1 mM and 0.5 mM concentrations of both SA and acetyl SA proved effective not only against heat and drought stress, but also against low temperature stress (Senaratna *et al.*, 2000). Certain salicylates, such as 2,6-dihydroxy BA, aspirin and SA hastened the germination of carrot seeds at 5°C (Rajasekaran *et al.*, 2002). Priming pepper (*Capsicum annuum* L.) seeds imbibed in KNO₃ solution containing aspirin at a concentration range of 0.05-0.5 mM resulted in an increase in the germination percentage, and the germination at low temperature became faster and better synchronised (Korkmaz, 2005). Other hormones, such as methyl JA in the 0.001-0.005 mM range and spermine in the 1-5 mM range, had a similar effect, as shown in both pepper and watermelon seeds (Korkmaz *et al.*, 2004, Korkmaz, 2005). Higher concentrations may have an inhibitory effect on germination.

Another related compound, methyl SA, used at a final vapour concentration of 10⁻⁴ M for 1 day at room temperature, increased resistance against chilling injury in green bell pepper (*Capsicum annuum* L. cv. Century) freshly harvested on a warm day. Methyl JA application led to similar results (Fung *et al.*, 2004). Increases in respiration, particularly via the alternative pathway, have been observed in response to chilling. An

increase in the steady-state mRNA level of the genes for alternative oxidase has also been reported in rice at low temperature (Ito *et al.*, 1997). These increases may result in increased heat evolution, especially in chilling tolerant species. The increased capacity to produce respiratory heat after exposure to chilling temperatures may contribute to the cold-acclimation process (Moynihan *et al.*, 1995). The alternative respiratory pathway may moderate chilling injury by keeping the production of ROS in balance with the levels of antioxidants and active oxygen-scavenging enzyme systems. The expression patterns of alternative oxidase and of several other genes involved in the defence against oxidative stress before and during the early chilling period suggested that the pre-treatment of pepper fruit with methyl SA or methyl JA vapours increased preferentially the transcript levels of alternative oxidase. The increase in alternative oxidase transcript levels caused by methyl JA or methyl SA before cold treatment was correlated with a reduced incidence of chilling injury.

The positive effect of SA on cold tolerance was shown not only under chilling but also under freezing conditions in winter wheat (Tasgin *et al.*, 2003). Not only cold acclimation, but also exogenous SA used at 0.01, 0.1 and 1 mM concentrations decreased freezing injury in the leaves of plants grown under cold and control conditions. Cold conditions caused an increase in ice nucleation activity by apoplastic proteins, which were isolated from the leaves. Exogenous SA caused an increase in ice nucleation activity under cold and control conditions. These results show that SA can increase freezing tolerance in winter wheat leaves by affecting apoplastic proteins. However, this effect cannot be generalised as experiments with winter rye showed that the apoplastic proteins accumulated after SA treatment had no antifreeze activity (Yu *et al.*, 2001).

The *in vitro* conservation of germplasm is often achieved by reducing the rate of tissue growth to a minimum either by reducing the temperature or by withdrawing a nutrient from the medium or by adding a growth retardant. For the long-term conservation of plant germplasm, cryopreservation is actually a more valuable technique since, when frozen in liquid nitrogen, the metabolism ceases to function, tissues are maintained without growth and genetic alterations that do not take place even during a very long period of storage. Embryonic axes of Persian lilac (*Melia azedarach* L.) encapsulated in calcium alginate beads with sucrose and SA were subjected to the cryopreservation technique, involving dehydration and freezing in liquid nitrogen, or to cold preservation by storing the alginate beads in empty petri dishes for 4 months at 4°C. The 0.2 mM SA significantly enhanced the viability percentage of encapsulated embryonic axes (Bernard *et al.*, 2002). The SA used in these experiments did not interfere with the development of the axes at all; in fact, significantly better growth recovery was monitored on

axes which benefited from protection by SA during cryopreservation, probably due to better conservation of the integrity of the tissues. This suggests that the addition of SA to the encapsulation medium may help to reinforce the tolerance of the tissues, particularly for those that are sensitive to the dehydration caused by conservation procedures.

The growth of *Arabidopsis* plants under chilling conditions could be related to their SA levels (Scott *et al.*, 2004). *NahG* plants and Col-0 wild types grew at similar rates at 23°C, and the growth of both genotypes was slowed by transfer to 5°C. However, at 5°C, *NahG* plants displayed relative growth rates about one-third greater than Col-0, so that by 2 months *NahG* plants were typically 2.7-fold larger. This resulted primarily from greater cell expansion in *NahG* rosette leaves. Specific leaf areas and leaf area ratios remained similar in both genotypes. Net assimilation rates were similar in the two genotypes at 23°C, but higher in *NahG* at 5°C. Chlorophyll fluorescence measurements revealed no PSII photodamage in chilled leaves of either genotype. At 5°C Col-0 shoots accumulated SA, particularly in glucosylated form. A similar tendency was observed in *NahG* shoots at 5°C, but at greatly depleted levels. Growth and SA levels were also examined in SA-signalling and metabolism mutants at 5°C. The partially SA-insensitive *npr1* mutant displayed growth intermediate between *NahG* and Col-0, while the SA-deficient *eds5* mutant behaved like *NahG*. In contrast, the *cpr1* mutant accumulated very high levels of SA at 5°C and its growth was much more inhibited than that of the wild type. At both temperatures, *cpr1* was the only SA-responsive genotype in which oxidative damage was significantly different from that of the wild type.

2.5 Salinity

Soils with high salt contents already existed before the appearance of Man, but problems have only arisen since the spread of agriculture, and particularly irrigation. Salt stress affects around 20% of the world's cultivated areas and nearly half of the irrigated land. The ionic equilibrium is disturbed by a high salt concentration, leading to hyperosmotic stress in the plants. The regulation of ion homeostasis is a fundamental criterion for physiological activity in plants. Salt stress destroys the homeostasis in the water potential and ionic distribution at both cell and whole plant level. This drastic change in the equilibrium state causes damage at the molecular level, the cessation of growth and, eventually, to the death of the plant. In addition to these primary effects, oxidative damage is also frequently observed. High salt concentration primarily damages cell membrane integrity, the activity of various enzymes and the functioning of the photosynthetic apparatus.

Plants give a complex molecular response to salt stress. In salt-tolerant (halophytic) plants several mechanisms are available to counteract salt stress, the most important of which are: i) the transportation of sodium and chloride ions from the cytoplasm to the vacuoles with the aid of Na⁺/K⁺-ATPases, leading to a higher concentration of K⁺ ions in the cytoplasm. Recent observations draw attention to the role of non-selective cation channels in regulating the entry of sodium ions into the cytoplasm, and that of certain ion transporters in maintaining the ionic equilibrium, or restoring it after salt stress. ii) The synthesis of the compatible osmolytes mentioned above and the conversion of certain ions into less soluble forms. iii) An increase in the enzyme concentration to overcome the enzyme inhibition caused by higher salt concentrations. iv) Modifications in photosynthesis, respiration and the hormone metabolism. The latter involves increases in ABA and ethylene and decreases in cytokinins.

It has been shown that SA could provide multiple stress tolerance (Senaratna, 2000). Similarly, soaking wheat seeds in SA solution provided protection against not only drought, but also salinity stress (Hamada and Al-Hakimi, 2001). By contrast, SA may promote the formation of ROS in the photosynthetic tissues of *Arabidopsis* plants during salt stress and osmotic stress. The widespread necrotic lesions observed on the shoots of wild-type plants after NaCl or mannitol treatment were not exhibited by *NahG* plants, incapable of SA accumulation (Borsani *et al.*, 2001).

SA pre-treatment also provided protection against salinity in tomato plants, probably due to the increased activation of aldose reductase and APx enzymes and to the accumulation of osmolytes, such as sugars, sugar alcohol or proline (Tari *et al.*, 2002, 2004; Szepesi *et al.*, 2005).

The soaking of wheat (*Triticum aestivum* L.) seeds in 0.05 mM SA also reduced the damaging effects of salinity on seedling growth and accelerated the growth processes (Shakirova *et al.*, 2003). The treatment of wheat plants with SA increased the level of cell division within the apical meristem of seedling roots, causing an increase in plant growth and elevated wheat productivity. It was found that SA treatment caused the accumulation of both ABA and indoleacetic acid, but did not influence cytokinin content, while diminishing the changes in phytohormone levels in wheat seedlings, under salinity. A high ABA level was also maintained in wheat seedlings, treated with SA. The SA-induced increase in ABA might contribute to the pre-adaptation of plants to stress, since ABA is known to have a key role in inducing the synthesis of a range of stress proteins ensuring the development of antistress reactions, for example, the maintenance of proline accumulation. The stress-induced accumulation of active oxygen species and, therefore, the level of SOD and peroxidase activity in the roots of young wheat seedlings, pre-treated with SA, were significantly lower than in

untreated plants, indicating that these enzymes contribute to the protective effect of SA on plants under conditions of salination (Sakhabutdinova, 2004).

Certain abiotic stresses, such as salt, cold and drought greatly stimulated the expression of the AcPMP3-1 and AcPMP3-2 genes coding for plasma membrane protein in the monocotyledonous halophyte *Aneurolepidium chinense*. ABA, H₂O₂ and SA also triggered the expression of AcPMP3 genes. The expression of the AcPMP3-1 gene was able to restore yeast mutants, lacking the Na⁺/H⁺ antiporter and Na⁺-ATPase, Na⁺ efflux systems and the transformants accumulated lower amounts of Na⁺ than the mutant cells under saline conditions (Inada *et al.*, 2005). These results suggested that AcPMP3-1 acted as a regulator of both Na⁺ and K⁺ accumulation in the cells. *In situ* hybridization showed that the AcPMP3-1 transcript was localized in the cells of the root cap and root epidermis, making it highly probable that AcPMP3-1 is essential for regulating Na⁺/K⁺ transportation between plant roots and the outer environment, under salt stress.

An increase in the NaCl level often reduces the germination percentage, the growth parameters and the contents of potassium, calcium, phosphorus and insoluble sugars both in shoots and roots. It may also reduce photosynthetic pigment contents and increase the electrolyte leakage from the cells. SA pre-treatment (grain soaking in 1 mM SA solution prior to sowing) increased the relative water content, the fresh and dry mass, the contents of water, photosynthetic pigments, insoluble saccharides and phosphorus, and peroxidase activity in salt-stressed barley seedlings. By contrast, the Na⁺ and soluble protein contents, the lipid peroxidation level and the electrolyte leakage were markedly lower under salt stress with SA than without it. Under stress conditions, plants pre-treated with SA exhibited less Ca²⁺ and more K⁺ accumulation and soluble sugars in roots at the expense of these contents in the plant shoots. The application of exogenous SA appeared to induce a pre-adaptive response to salt stress, leading to the promotion of protective reactions to the photosynthetic pigments and the maintenance of membrane integrity in barley plants, which was reflected in an improvement in plant growth (El Tayeb, 2005).

It was also recently shown that salt-induced protein (SALT) was present in the xylem parenchyma cells of vascular bundles in the major and minor leaf veins. The expression of the gene encoding SALT was up-regulated following the treatment with a fungal elicitor, JA, ABA, or NaCl. However, SA alone or in combination with one of the other elicitors not only strongly inhibited SALT gene expression but also exhibited an antagonistic effect in suspension cells and leaves (Kim *et al.*, 2004).

2.6 Ozone stress

Ozone is responsible for more crop losses than any other air pollutant. It is formed through photochemical reactions between nitrogen oxides, carbon monoxide and hydrocarbons released, primarily, through the burning of fossil fuels in urban areas (Mauzerall and Wang, 2001). Ozone production is particularly favoured in summer months by strong sunlight, high temperature and stagnant high-pressure systems and concentrations, therefore, tend to be at their highest during the growing season of most of the world's crop plants. Long-term chronic exposure to ozone can lead to a reduction in growth and crop yield, resulting from the inhibition of photosynthesis, premature senescence, altered biomass partitioning and changes to reproductive processes (Black *et al.*, 2000; Pell *et al.*, 1997; Saitanis and Karandinos, 2002; Sandermann, 1996). Ozone is also able to act as an abiotic elicitor of plant defence reactions and acute exposure can result in the appearance of small necrotic hypersensitive response (HR)-like lesions on foliage (Rao and Davis, 2001). Ozone is toxic to plants and animals because it is a powerful oxidizing agent, which is able to react directly with lipids and proteins. Such reactions and the decomposition of ozone in aqueous environments such as the plant apoplast can lead to the production of other ROS such as the hydroxyl radical, singlet oxygen and H₂O₂ (Kanofsky and Sima, 1991; Mehlhorn *et al.*, 1990; Evans *et al.*, 2005).

The primary site of ozone interaction with plant cells is the extracellular matrix where ozone challenges the antioxidant protection of the cells (Baier *et al.*, 2005). Accordingly, ozone sensitivity is generally correlated with the ascorbate status of the leaf tissue (Conklin & Barth 2004), which can accumulate to millimolar concentrations in leaf apoplasts, where it may scavenge significant amounts of ozone. Ozone sensing takes place through the covalent modification of redox-sensitive components of the plasma membrane, for example ion channels such as the plasma membrane Ca²⁺-channels. This modification has been characterized as the earliest response to ozone, resulting in an elevation in cytosolic-free calcium, which takes place within seconds of exposure (Evans *et al.*, 2005). Ozone was found to elicit distinct calcium responses in the aerial tissue and roots of seedlings. The calcium response in the cotyledons and leaves was biphasic and sensitive to the rate at which the ozone concentration increased. The response in the root was monophasic and insensitive to the rate of increase in ozone concentration. Experiments utilizing inhibitors of the antioxidant metabolism demonstrated that the magnitude of the first peak in Ca²⁺ in the aerial tissues was dependent upon the redox status of the plant. Seedlings were shown to be able to distinguish between ozone and H₂O₂, producing a Ca²⁺ signal in response to one of these ROS when they had become

refractory to the other. Pre-treatment with ozone altered the Ca^{2+} response to H_2O_2 and vice versa, indicating that the Ca^{2+} response to a given ROS may reflect the stress history of the plant. Subsequent intracellular signal transduction is an intriguing network of hormone, Ca^{2+} and MAPK signalling pathways, significantly overlapping with oxidative burst-induced pathogen signalling. A change in the expression of several genes in response to ozone has been documented (Pell *et al.*, 1997; Sandermann *et al.*, 1998), including the genes of antioxidant enzymes, which may offer some protection against further oxidative stress (Conklin and Last, 1995).

Ozone treatment led to the accumulation of SA, the synthesis of PR protein and the development of virus resistance in tobacco (Yalpani *et al.*, 1994). The role of SA in counteracting ozone stress was also demonstrated in *Arabidopsis* plants, where *NahG* plants were more sensitive to the damaging effect of ozone. The synthesis of some of the ozone-induced mRNAs was SA-dependent, so only a few were found in transgenic plants. Plants exposed to ozone exhibited enhanced resistance to virulent *Pseudomonas syringae* strains. The results indicate that there is overlapping between the development of ozone- and pathogen-induced resistance and that both are SA-dependent (Sharma *et al.*, 1996). Other authors reported that both a deficiency and an excess of SA caused greater ozone sensitivity (Rao and Davis, 1999). The Cvi-0 *Arabidopsis* genotype, which accumulates SA, is ozone-sensitive, since the large quantity of SA induces oxidative processes during ozone stress, leading to cell death similar to that caused by the hypersensitive reaction. In *NahG* plants, however, which are incapable of accumulating SA, the lack of a satisfactory antioxidant response led to increased ozone sensitivity (Rao and Davis, 1999). In the Cvi-0:*NahG* genotype the lack of SA reduced the level of ozone-induced cell death.

Recent studies demonstrate that ethylene, JA and SA signalling pathways do not act independently, but interact in a complex manner to regulate plant defence responses (Feys and Parker, 2000; Rao and Davis, 2001). Ethylene is a plant hormone that promotes leaf damage in ozone-exposed plants. Ethylene-responsive factors (ERFs) are important in regulating plant pathogen resistance, abiotic stress tolerance and plant development. A tomato ERF protein, TSRF1, was also recently shown to be transcriptionally up-regulated by ethylene, SA or pathogen infection (Zhang *et al.*, 2004). SA inhibits JA biosynthesis and/or JA-dependent gene expression (Gupta *et al.*, 2000). Conversely, JA inhibits the SA pathway in response to wounding (Niki *et al.*, 1998). Pre-treatment with methyl JA hindered the accumulation of SA or H_2O_2 , thus preventing ozone-induced necrosis (Rao *et al.*, 2000). The interactions between ethylene, JA and SA that are induced by ozone, and the inhibition of the ethylene or SA pathways by JA have also been investigated. It was shown that active oxygen species mediated SA

biosynthesis and that the SA signalling pathway in the ozone-sensitive ecotype was influenced by the JA pathway (Rao *et al.*, 2000). In addition, plants with deficient SA signalling failed to produce ethylene in response to ozone, indicating that the SA pathway is required for ethylene signalling (Rao *et al.*, 2002). The results of a cDNA macroarray assay indicate that ozone-induced defence gene expression was mainly regulated by ethylene and JA at this stage, and that the SA pathway acts as a strong antagonist to gene expression, induced by ethylene and JA signalling (Tamaoki *et al.*, 2003).

SA biosynthesis has also been investigated during ozone fumigation. When C¹⁴-labelled BA was applied to ozone-exposed tobacco leaves, it was efficiently metabolized to SA (Ogawa *et al.*, 2005). However, there was no increase in the activity or mRNA level of isochorismate synthase. In contrast, the activity of this enzyme was increased in ozone-exposed *Arabidopsis*. These results suggest that SA is synthesized via BA from phenylalanine in ozone-exposed tobacco leaves but via isochorismate in *Arabidopsis*. During ozone exposure, transgenic plants with reduced ozone-induced ethylene production accumulated less SA than did wild-type plants. Ozone increased the activity of phenylalanine ammonia-lyase and the transcript levels of the chorismate mutase and phenylalanine ammonia-lyase genes in wild-type tobacco, but their induction was suppressed in the transgenic plants. These results indicate that ethylene promotes SA accumulation by regulating the expression of the chorismate mutase and phenylalanine ammonia-lyase genes in ozone-exposed tobacco plants. A comparison of recent transcriptome analysis revealed that in addition to genes generally induced by all kinds of oxidative stress, for example, transcripts for PR-proteins and most antioxidant enzymes, approximately one-third of the responsive transcripts are ozone-specific, indicating JA, SA and ethylene-independent redox signalling triggered by extracellular redox sensing. These data suggest ROS signalling is more sophisticated than previously realized and raise questions about current models of ozone perception (Evans *et al.*, 2005).

2.7 Ultraviolet radiation

Depletion of the stratospheric ozone layer may result in an increase in the level of potentially harmful ultraviolet (UV) radiation reaching the surface of the earth. UV radiation is traditionally divided into UV-A (320-400 nm), UV-B (280-320 nm) and UV-C (200-280 nm) wavelength ranges, which have increasing level of energy and harmful effects. Plants, which use direct sunlight for photosynthesis are unable to avoid UV radiation, therefore,

mechanisms which may protect them from the harmful effects of UV radiation are of particular interest (Hollósy, 2002)

Like ozone, UV radiation was shown to induce the accumulation of SA, while also stimulating PR-protein synthesis and inducing virus resistance in tobacco plants (Yalpani *et al.*, 1994). Increased SA levels were accompanied by the accumulation of an SA conjugate and by an increase in the activity of BA 2-hydroxylase, which catalyses SA biosynthesis. This was paralleled by the appearance of induced resistance to a subsequent attack by tobacco mosaic virus. The results suggest that UV light, ozone fumigation and tobacco mosaic virus can activate a common signal transduction pathway that leads to SA and PR-protein accumulation and increased disease resistance (Yalpani *et al.*, 1994).

Besides heat stress, UV-B radiation may also significantly contribute to the quality decline and death of Kentucky bluegrass (*Poa pratensis* L.) during summer transplanting. UV-B irradiation stress substantially reduced the turf quality and photochemical efficiency when measured 10 days after the initiation of UV-B. Antioxidants and protective pigments may be involved in plant defence against oxidative stress caused by UV-B. It was recently shown that exogenous SA at 150 mg m⁻² may alleviate UV-B damage by upregulating plant defence systems (Ervin *et al.*, 2004). Endogenous α -tocopherol, SOD and catalase were reduced by UV-B stress. The anthocyanin content increased from day 1 to day 5 and then decreased from day 5 to day 10 of continuous UV-B irradiation. The application of SA enhanced the photochemical efficiency by 86% when measured 10 days after UV-B initiation. In addition, the application of SA increased the α -tocopherol concentration, the SOD and catalase activity and the anthocyanin content compared to the control 10 days after UV-B initiation, leading to better visual quality under UV-B stress. These results suggest that the foliar application of SA may alleviate the decline in photochemical efficiency and turf quality associated with increased UV-B light levels during the summer.

3. POSSIBLE ACTION MECHANISMS

3.1 SA-induced gene expression

As indicated above, the abiotic stress tolerance, induced by SA, may have various causes. Resistance to many stress factors, however, can be attributed to common properties. As already illustrated in previous sections, there are several genes which can be induced by both biotic and abiotic

stress factors, while several "stress-related" compounds, such as ABA, H₂O₂, etc. as well as SA may also induce their expression (Salzman *et al.*, 2005).

Although abiotic stresses affect plant growth and development, its direct effect on the regulation of the components of the DNA replication machinery is still largely unknown. It was shown that the expression of TOP2 which encodes topoisomerase II, is up-regulated by various abiotic stresses including salinity and low temperature, and by phytohormones such as ABA and SA (Hettiarachchi *et al.*, 2005). Transgenic studies on various deletion versions of the TOP2 promoter in tobacco define several promoter determinants responsible for specific abiotic stress responsiveness. These results demonstrate the direct involvement of stress in the transcriptional regulation of TOP2. The differential expression of the gene coding for a chloroplast translation elongation factor (EF-Tu) in response to various abiotic stresses in pea showed that it is down-regulated in response to salinity and ABA and up-regulated in response to low temperature and SA treatment. These results indicate that the regulation of this gene in pea may have an important role in plant adaptation to environmental stresses (Singh *et al.*, 2004).

Mobile genetic elements play a crucial role in the genome restructuring, induced by environmental challenges (McClintock, 1984). According to this theory, the transcription and transposition of these elements should be greatly influenced by external factors such as biotic and abiotic stress conditions. The TLC1 family is one of the four families of long terminal repeat retrotransposons identified in the genome of *Lycopersicon chilense*. It was shown that this family of retroelements is transcriptionally active and its expression is induced in response to diverse stress conditions such as wounding, protoplast preparation and high salt concentrations, but not drought stress (Tapia *et al.*, 2005). Several stress-associated signalling molecules, including ethylene, methyl JA, SA, and 2,4-dichlorophenoxyacetic acid, but not ABA or H₂O₂, are capable of inducing the expression of the TLC1 family *in vivo*.

Cyclophilins (Cyp) are ubiquitous proteins with intrinsic peptidyl-prolyl cis-trans isomerase activity that catalyses the rotation of X-Pro peptide bonds and facilitates the *in vivo* folding of proteins. Usually, higher amounts of Cyp mRNAs are found in developing tissues (Marivet *et al.*, 1994). Cyp mRNA accumulates in leaves infected with alfalfa mosaic virus and after ethephon and SA treatments in bean. In response to localized chemical treatment, Cyp mRNA accumulation was observed in the untreated parts of the plants. A comparative study of Cyp mRNA accumulation in bean and maize in response to various external stimuli showed striking differences in profiles between the two plants. For instance, in response to heat shock, maize Cyp mRNA accumulated to a significant extent, whereas no mRNA

was found to remain in bean a few hours after the beginning of the heat stress. Two putative heat shock elements were identified in the promoter region of a maize Cyp genomic clone; a metal regulatory element and a third heat shock element were localized in the 5' untranslated leader (Marivet *et al.*, 1995). Differences in mRNA accumulation profiles are also observed after salt stress, which induces a response earlier in maize than in bean, whereas the opposite situation is observed when plants are cold-stressed. All these findings suggested that cyclophilin might be a stress-related protein and might play a role in signal transduction processes (Marivet *et al.*, 1994). The StCyP clone encoding a cytosolic form of Cyp was isolated from a cDNA library prepared from potato (*Solanum tuberosum*) tubers infected with the fungus *Solani f. sp. eumartii* (Godoy *et al.*, 2000). StCyP is expressed at high levels in all the tissues of healthy potato plants, except in the tubers. Northern blot analysis revealed that both wounding and fungal infection increased the level of StCyP mRNA in tubers. StCyP mRNA accumulation is also stimulated by heat-shock or by the application of ABA or methyl JA in tubers, but not by fungal elicitor or, in contrast to bean plants, by SA.

Studies were also made on the effect of SA on the synthesis of HSPs in tomato. It was found that, although a low concentration of SA alone was unable to induce HSP synthesis, it promoted heat-induced synthesis. At higher, cytotoxic concentrations (1 mM), SA alone was able to induce Hsp70/Hsc70 expression (Cronje and Bornman, 1999).

Some genes can be induced by both drought and SA. For example, the expression of a water stress-induced gene from *Brassica oleracea* (BoWS), encoding a 95-amino-acid protein, was upregulated by ABA, mannitol, NaCl, drought, SA and H₂O₂, indicating that this gene is closely related to water-deficit stress in this species (Li *et al.*, 2004). Transcripts of the BcDh2 dehydrin-like gene isolated from *Boea crassifolia* accumulated to a great extent when the plants were exposed to drought, salinity, exogenous ABA and moderate heat shock, while accumulation was low in response to low temperature stress. BcDh2 also accumulated slightly in response to wounding signals such as MeJA and a low concentration of SA (Shen *et al.*, 2004). By contrast, transcripts of another drought-inducible gene BcMYBI, which was strongly induced by drought stress and also responded to polyethylene-glycol (PEG), high salinity and low temperature, did not accumulate to any great extent after treatment with exogenous ABA, methyl JA or SA. These results indicate that BcMYBI might be involved in the regulation of gene expression in response to dehydration stress through an ABA-independent pathway, but does not seem to be a regulatory component in wounding signalling (Chen *et al.*, 2005). Differential responses to drought and SA were also exhibited by other genes, such as the BnBDC1 gene,

which encodes a protein containing the BURP domain, and which was isolated from oilseed rape (*Brassica napus*) following drought treatment (Shunwu *et al.*, 2004). The transcript of this gene was found to be specifically expressed in the shoots, but not in the roots. The expression level of the BnBDC1 transcript is upregulated by mannitol, NaCl and ABA, and downregulated by UV irradiation and SA, while it is unresponsive to H₂O₂ and cold treatment. The expression level of BnBDC1 was significantly reduced after SA treatment and the effect was prolonged beyond 2 days, indicating that BnBDC1 is one of the target genes in the SA signalling pathway. Although there is insufficient information to assess the precise function of BnBDC1, it is probably involved in multiple cell signalling pathways, and may play an important role in the response to osmotic stress and plant pathogen infection in *Brassica napus*.

A submergence-induced gene, OsGGT, was recently cloned from submerged plants of a submergence-tolerant cultivar of rice (*Oryza sativa* L.) (Qi *et al.*, 2005). Its deduced amino acid sequence is homologous with glycogenin glucosyltransferase. The expression of this gene increased during submergence in the submergence-tolerant cultivar, but decreased in a submergence-intolerant cultivar. The expression of the OsGGT gene in the tolerant cultivar was induced by SA and benzyladenine. The accumulation of OsGGT mRNA also increased in response to ethylene, gibberellin, ABA, drought and salt treatment, but methyl JA treatment and cold stress had no effect. These results suggest that the OsGGT gene could be related to submergence stress and associated with a general defensive response to various environmental stresses.

The SAR8.2 genes of pepper (*Capsicum annuum* L.), designated CASAR82A, B and C, which are induced by all biotic and abiotic stresses, are not constitutively expressed in any of the organs of healthy pepper plants. Besides induction by pathogens, a strong induction of the CASAR82A gene was found in pepper leaves treated with ethylene, methyl JA, indole-3-acetic acid, ABA, SA, benzothiadiazole, DL-beta-n-amino butyric acid or H₂O₂. Interestingly, the transcription of the CASAR82A gene was rapidly triggered by high salinity, drought or low-temperature stresses, but not by mechanical wounding. *In situ* hybridization results revealed that the CASAR82A mRNAs were localized in the phloem and epidermal cells of pepper leaf and stem tissues infected by *Colletotrichum coccodes* and *Phytophthora capsici*, or treated with SA. These results suggest that pepper SAR8.2 genes may be valuable as molecular markers for the detection of various pathogen infections, abiotic elicitors and environmental stresses (Lee and Hwang, 2003).

In *Arabidopsis*, the cytosolic, patatin-related phospholipase A enzymes (PLA) comprise a family of 10 genes, designated AtPLAs and thought to be

involved in auxin and pathogen signalling (Holk *et al.*, 2002). The first indication that plant PLA had a function in signal transduction was the rapid activation of PLA activity by auxin (Scherer and André, 1989). Later, the activation of PLA by pathogens and elicitors was shown (Lee *et al.*, 1992). Its synthesis is up-regulated after treatment by SA, benzo[1,2,3]thiadiazole-7-carbothionic acid-S-methylester (Bion), wounding, ACC and JA. The properties of this member of the patatin-related phospholipase A gene family suggest that it is a defence, iron-stress and phosphate-stress gene, being transcriptionally up-regulated within hours or days (Rietz *et al.*, 2004).

Chloroplastic lipoxygenase, CPRD46, a single copy gene isolated from dehydrated cowpea (*Vigna unguiculata*) plants, was shown to be induced by high-salinity stress and exogenous ABA, but not by cold stress. The CPRD46 gene is also responsive to heat stress, methyl JA and SA (Iuchi *et al.*, 1996).

Glycine-betaine is an osmoprotectant accumulated by barley (*Hordeum vulgare*) plants in response to high levels of NaCl, drought, cold stress or ABA treatment (Jagendorf and Takabe, 2001). Additional inducers of glycine-betaine accumulation have been detected in barley seedlings, including other inorganic salts, oxidants and organic compounds. The same concentrations of aspirin or SA (added to the hydroponic solution as sodium salicylate) that induced glycine-betaine accumulation increased TBARS level. Since H₂O₂ also increased the glycine-betaine level, the glycine-betaine-inducing effect of salicylates can be explained by their ability to increase the H₂O₂ level. Although illumination is needed for optimal induction, a significant increase in the leaf glycine-betaine level is also found in complete darkness.

Among the growing list of promising genes for plant improvement, some of the most versatile appear to be those involved in the sugar alcohol metabolism. Mannitol, one of the best known sugar alcohols, is a significant photosynthetic product in many higher plants. In addition to its osmoprotectant properties, mannitol is an antioxidant and may have a significant role in plant-pathogen interactions. The catabolic enzyme mannitol dehydrogenase is a prime modulator of mannitol accumulation in plants. An up-regulation by SA and down-regulation by salt, osmotic stress and ABA was recently shown for its *mtd* gene in *Arabidopsis* plants (Zamski *et al.*, 2001). In contrast, the massive up-regulation of the expression of this gene in the vascular tissues of salt-stressed *Arabidopsis* roots suggests a possible role for mannitol dehydrogenase in mannitol translocation and unloading and its interrelation with the sugar metabolism.

Osmotin was detected in tobacco cells, exposed to gradually increasing concentrations of NaCl, which led to phenotypic adaptation and increased tolerance to NaCl (Singh *et al.*, 1987). A cDNA clone encoding osmotin,

PhOSM, was isolated from a cDNA library constructed from petal protoplast cultures of *Petunia hybrida* (Kim *et al.*, 2002). This gene was expressed primarily in roots and slightly in the pistil, 3 days after flowering. Its expression was strongly induced in leaves that were exposed to certain pathogens. Upon wounding, PhOSM transcripts were induced in the damaged leaf, but not systemically. Moreover, PhOSM transcript levels increased in response to octadecanoid pathway intermediates and treatment with aspirin or SA. These results indicate that PhOSM is developmentally regulated as well as being involved in stress signal transduction.

Investigations on the expression of SbPRP gene, encoding a soybean proline-rich protein showed that it accumulates in the leaves and epicotyls of soybean seedlings, but not in the cotyledons, hypocotyls or roots (He *et al.*, 2002). SbPRP mRNA was also expressed in response to SA and virus infection. In addition, SbPRP gene transcription was regulated by circadian rhythm, salt stress, drought stress and plant hormones. These results indicate that the SbPRP gene might play a role in plant responses to multiple internal and external factors. The expression of another proline-rich protein, encoded by the PvSR1 (*Phaseolus vulgaris* stress-related protein) gene, was greatly enhanced in the leaf tissue not only by alfalfa mosaic virus infection, wounding, heat shock, UV, drought and salt stress, but also by exogenous factors such as SA and H₂O₂. The precise biological role of PvSR1 is still unknown, but the expression of PvSR1 genes, in various forms of stress, suggests that PvSR1 may play an important role in maintaining cellular integrity during the stress, by forming strong linkages with the cell wall (Chai and Zhang, 1999).

Using the microarray technique several cytochrome P450 genes were detected in *Arabidopsis*, of which the expression was induced not only by biotic and abiotic stresses, but also by hormone treatments, including SA, suggesting cross-talk between different types of stress factors (Narusaka *et al.*, 2004). Most cytochrome P450 genes induced by both abiotic and biotic stresses, contained the recognition sites of MYB and MYC, ACGT-core sequence, TGA-box and W-box for WRKY transcription factors in their promoters. These cis-acting elements are known to participate in the regulation of plant defence. The response of each gene to multiple stress is strictly regulated. Multiple forms of cytochrome P450-dependent monooxygenases catalyse the in-chain hydroxylation, end-terminal hydroxylation, and epoxidation of medium- and long-chain fatty acids. In plants, fatty acid hydroxylases are particularly important in the synthesis of plant cuticles and signalling molecules derived from fatty acids. Some members of the *Arabidopsis thaliana* CYP86A and CYP94B cytochrome P450 monooxygenase subfamilies, which share some sequence homology with animal and fungal fatty acid hydroxylases, have been functionally

defined as fatty acid omega-hydroxylases. Due to these activities, these and other fatty acid hydroxylases have a potential role in the synthesis of cutin, the production of signalling molecules, and the prevention of the accumulation of toxic levels of free fatty acids. The constitutive and stress-inducible patterns of the five *Arabidopsis* CYP86A subfamily members have now been defined (Duan and Schuler, 2005). Very distinct expression patterns exist for each of these fatty acid hydroxylases under normal growth conditions and in response to environmental and chemical stresses. CYP86A1 transcripts were transiently induced by ABA and ACC treatments, more continuously induced by mannitol and clofibrate treatments, and more slowly induced by cold treatment and brassinosteroid treatments, while they were repressed by IAA and SA treatments. CYP86A2 transcripts were transiently induced by wounding, ABA, mannitol, IAA and clofibrate treatments, more continuously induced by drought treatment, and induced more intensively in etiolated and dark-adapted seedlings compared to light-grown seedlings of the same age. CYP86A4 transcripts were transiently induced by ABA and IAA treatments and more continuously induced by cold treatment. In contrast to the transient responses of other CYP86A transcripts, CYP86A4 transcripts were repressed by short-term ACC treatment and induced by long-term ACC treatment. These transcripts were also repressed by wounding in etiolated seedlings. CYP86A7 transcripts were transiently induced by clofibrate treatment, more continuously induced by MeJA treatment, and slowly induced by ABA treatment, while being significantly repressed by drought, SA, wounding, ACC and mannitol treatments. CYP86A8 transcripts were induced only by IAA and ABA treatments and repressed by wounding. An analysis of the promoter sequences for each of these genes together with their expression patterns has highlighted a number of elements in current databases that potentially correlate with the responses of individual genes. The observed patterns of inducible expression suggest that, in addition to their roles in normal growth and development, each of these P450s has a particular role in stress responses, although these results also suggest that the activation of these CYP86A genes does not involve SA- or MeJA-dependent pathways (Duan and Schuler, 2005).

The detection and development of gene promoters specific for the pericarp epidermis (epicarp) of barley (*Hordeum vulgare* L.) is a critical step in the targeting of transgene-mediated disease resistance, since this tissue constitutes an early point of entry and proliferation of *Fusarium graminearum*, the main causal agent of disease. Plant lipid transfer proteins (LTPs) were defined by their ability to facilitate the transfer of phospholipids between membranes *in vitro*. Suggested roles *in planta* include the formation and reinforcement of plant surface layers,

embryogenesis, defence against pathogens, symbiosis, and adaptation to various abiotic stress conditions (Kader, 1996). Transcripts of the TaLTP1 gene were increased by water stress, such as treatment with various PEG concentrations or NaCl, hormone treatment (SA, ethephon), H₂O₂, or wounding (Jang *et al.*, 2004). The search for a cereal promoter capable of driving preferential transgene expression in the pericarp epidermis of developing barley resulted in the cloning of a novel gene (Federico *et al.*, 2005). This encoded a polypeptide of 124 amino acids showing 87% identity with WBP1A, a wheat lipid transfer protein, but much lower homology to other barley LTPs. In addition to the epicarp, this Ltp-like gene, *Ltp6*, is highly expressed in coleoptiles and embryos under normal growth conditions. In contrast to other Ltps, such as *Ltp3* or *Ltp4*, the expression of which was increased by salt and ABA but not by drought, cold, or SA in leaves, mRNA levels of *Ltp6* increased in seedling tissues during salt and cold treatments and after the application of ABA and SA. An ATMYB2A-binding site was found in the *Ltp6* promoter. The *Arabidopsis* AtMyb2A gene encodes an MYB-related protein, which is strongly induced by ABA, drought and high salt (Urao *et al.*, 1993). If an MYB transcription factor related to ATMYB2A exists in barley, this MYB-binding site could account for the ABA and high salinity response observed in the *Ltp6* gene. In *Arabidopsis*, low temperature responsive elements, containing the CCGAC core-motif, have been found in many cold- and drought-responsive genes (Shinozaki and Yamaguchi-Shinozaki, 1996). *Ltp6* consists of a sequence which could represent a binding site for both the HvCBF1 and HvCBF2 barley transcription factors, which have been shown to activate cold-inducible genes through a CCGAC core-motif (Xue, 2002; 2003), and which might account for the responsiveness of *Ltp6* to cold stress. The presence of putative ABA- and gibberellin-responsive elements in the promoter region suggests that *Ltp6* may respond to either gibberellin or ABA under certain developmental or stress conditions (Federico *et al.*, 2005).

The expression of the *Arabidopsis* phospholipase A IIA (AtPLA IIA) gene, which is a member of the patatin-related PLA gene family in plants and is homologous to the Ca²⁺-independent PLA₂ gene family in animals, was induced by various treatments such as pathogen inoculation, cold, high salinity, ABA, SA (sprayed at a concentration of 5 mM), methyl JA, ethephon, paraquat, rose bengal, UV-C and CuSO₄ (Narusaka *et al.*, 2003). The sequences of putative cis-acting elements were found in the promoter region of the AtPLA IIA gene. This gene has two ACGT-sequences and a TGA-box in the promoter, which are known to be the core sequences of activation sequence-1 (Lam *et al.*, 1989), which acts as an oxidative stress-responsive element. Therefore, these sequences may function as cis-acting elements in the ROS-responsive promoters. The AtPLA IIA gene was also

induced by both osmotic stress and ABA treatment. Although the signalling factors involved in the induction of AtPLA IIA are unclear, it may play an important role in plant defence responses.

3.2 Relationship with oxidative stress

It is a well-known fact that most stress factors, whether biotic or abiotic, are usually associated with oxidative stress. This relationship may be indirect or secondary, as in the case of flooding stress, which may activate the antioxidant system in spite of the fact that it tends to cause oxygen deficiency (Yordanova *et al.*, 2004). In many cases the increased tolerance can be attributed to the efficiency with which the plant is capable of neutralising ROS.

Exposure to sublethal biotic and abiotic stresses renders plants more tolerant to a subsequent, normally lethal, dose of the same stress, a phenomenon referred to as acclimation or acquired resistance (Vierling, 1991; Sticher *et al.*, 1997). In fact, this induced stress resistance is not restricted to the same type of stress, cross-tolerance having been reported between different stresses (Strobel and Kuc, 1995; Bowler and Fluhr, 2000; Chini *et al.*, 2004). Antioxidant defence responses have long been associated mainly with enhanced antioxidant enzyme activity and increased levels of antioxidant metabolites, such as ascorbic acid, glutathione, α -tocopherol and carotenoids. More recently, the induction of small HSPs, the cellular protection gene glutathione-S-transferase, and the PR gene *PR2* have also been associated with the acquisition of oxidative stress tolerance (Vranová *et al.*, 2002).

When applied at suitable concentrations, SA causes transient oxidative stress in plants, which acts as a hardening process, increasing the antioxidative capacity of the plants (Knörzer *et al.*, 1999) or inducing the synthesis of stabilising substances such as polyamines (Németh *et al.*, 2002). In tobacco and cucumber plants SA moderated the oxidative stress caused by paraquat (Strobel and Kuc, 1995). When young barley plants were treated with 0.5 mM SA for 1 day in the dark, the inhibitory effect of paraquat on photosynthesis could be averted. There was also a reduction in the H_2O_2 production, lipid peroxidation and membrane damage, induced by paraquat (Ananieva *et al.*, 2002). At higher concentrations, however, SA itself may cause a high level of stress.

One frequent result of both SA treatment and the acclimatisation process is a temporary reduction in catalase activity and a rise in the H_2O_2 level (Janda *et al.*, 2003). The increased H_2O_2 level is mainly the result of the effect of SA on antioxidant enzymes (Klessig *et al.*, 2000; Ganesan and Thomas, 2001). In *Arabidopsis* a long course of SA treatment reduced the

activity of APx as well as that of catalase, leading to cell death similar to the hypersensitive reaction (Rao *et al.*, 1997). SA also led to a reduction in catalase and APx activity in *Astragalus adsurgens* Pall. callus culture, resulting in an increase in the H₂O₂ level (Luo *et al.*, 2001). SA has proved capable of binding directly to catalase enzyme, isolated from tobacco, inhibiting its activity (Chen *et al.*, 1993b; Conrath *et al.*, 1995). The *in vitro* catalase-inhibiting effect of SA has also been demonstrated in many other plant species (e.g. *Arabidopsis*, tomato, cucumber) (Sánchez-Casas and Klessig, 1994; Horváth *et al.*, 2002). It is thought that the increased H₂O₂ level produced by the catalase-inhibiting effect of SA may play a role in the development of SAR (Chen *et al.*, 1993a) and in the defence against abiotic stress effects involving oxidative damage (Gechev *et al.*, 2002). Nevertheless, the significance of catalase inhibition in the induction of resistance is still dubious, partly because the binding of SA to catalase is not specific (it also binds to other iron-containing proteins such as aconitase; Ruffer *et al.*, 1995), and partly because inhibition has not been observed unambiguously for all plant species. In tobacco all the catalase isoenzymes are inhibited by SA (Durner and Klessig, 1996), but in maize and rice a significant level of inhibition could not be detected (Sánchez-Casas and Klessig, 1994). Mild inhibition was caused by 1 mM SA in the activity of the CAT2 isoenzyme isolated from maize scutellum (Guan and Scandalios 1995). This contradiction was partially solved when later studies found differences between the catalase isoenzymes in their sensitivity to SA, both in maize and rice. A substantial level of non-competitive inhibition was caused by 2 mM SA in the activity of the CAT1 isoenzyme of maize, while in the case of CAT2 the inhibition was competitive and weak (Horváth *et al.*, 2002). In rice SA inhibited the activity of the CATb isoenzyme, but not that of CATa (Chen *et al.*, 1997). The CAT1 isoenzyme of maize and the CATb isoenzyme of rice, both of which are sensitive to SA, exhibited considerable sequence homology with tobacco catalase, which is also inhibited to a great extent by SA. The tissue-specific expression of various catalase isoenzymes may lead to differences in the effect of SA on the given tissue if catalase does indeed play a role in transmitting the effect of SA.

As regards the mechanism of catalase inhibition, it is thought that SA might act as an electron donor, diverting catalase to the slower peroxidative pathway. At low levels of H₂O₂ this is manifested as inhibition, while at damaging levels of H₂O₂ it protects the enzyme (Durner and Klessig 1996). In the course of catalase inhibition, however, SA is converted into a free radical, which may then cause lipid peroxidation. Both the higher H₂O₂ level caused by catalase inhibition and the lipid peroxidation arising in the course of inhibition are thought to be involved in the signal transduction process leading to SA-dependent resistance (Anderson *et al.*, 1998). There is

evidence that not only does SA cause a rise in the quantity of ROS in the cell, but ROS also lead to the accumulation of SA (León *et al.*, 1995, Enyedi 1999). This observation suggested the existence of a self-induced SA-H₂O₂ cycle resulting in the accumulation of ROS and the death of the cell (Van Camp *et al.*, 1998). SA and its biologically active analogues may cause lipid peroxidation (Anderson *et al.*, 1998) and may also lead to oxidative damage to proteins and to the formation of chlorophyll and carotene isomers. H₂O₂ treatment alone did not cause such a great extent of damage to membranes or proteins. Dimethyl-thiourea, on the other hand, which reduces the level of H₂O₂, moderated the damaging effect of SA treatment (Rao *et al.*, 1997). A similar observation was made when the induction of somatic embryogenesis by SA was examined in callus culture of *Astragalus adsurgens* Pall. SA (0.2 mM) increased the level of endogenous H₂O₂, but exogenous H₂O₂ was unable to substitute fully for the effect of SA, while dimethyl-thiourea moderated the effect of SA by reducing the H₂O₂ level (Luo *et al.*, 2001). This suggests that the effect of SA is only mediated in part by H₂O₂. In addition to H₂O₂, a role may also be played by the SA free radical arising in the course of catalase inhibition and the consequent lipid peroxidation (Klessig *et al.*, 2000). Recent results revealed that the SA-induced H₂O₂ accumulation in germinating wheat seedlings was not associated with the inhibition of catalase or APx. It is suggested that the abiotic stress signal is transduced via ABA, Ca²⁺ and H₂O₂, which might be responsible for the activation of a common transcription factor associated with certain antioxidant enzymes (Agarwal *et al.*, 2005).

As previously mentioned, several studies have supported a major role of SA in modulating plant responses to abiotic and biotic stresses, by the induction of antioxidant capacity. In some cases SA stimulates the activity of the Cu- and Zn-SOD enzymes, which again may contribute to a rise in the H₂O₂ level (Rao *et al.*, 1997; Azevedo *et al.*, 2004). There are several enzyme systems capable of removing excess H₂O₂, including the ascorbate-glutathione cycle in the chloroplasts. The glutathione metabolism in plants may play a key role in determining the degree of expression of defence genes controlled by various signalling pathways both before and during stress. This control may reflect the physiological state of the plant at the time of the onset of an environmental challenge and suggests that changes in the glutathione metabolism may be one means of integrating the functions of different signalling pathways (Kocsy *et al.* 1997, 2001, 2004; Ball *et al.*, 2004). The activity of glutathione reductase is also stimulated by SA *in vivo*, as shown in mustard and maize plants after exogenous SA treatments (Dat *et al.*, 1998a, Janda *et al.*, 1999). Tobacco plants growing *in vitro* in the presence of 0.01 or 0.1 mM SA also showed increased glutathione reductase and dehydroascorbate reductase activity in the shoots, although there was no

significant effect on APx. SA at 0.1 mM also increased the monodehydroascorbate reductase (MDHAR) activity. The ascorbate redox-ratio was maintained in the shoots of plants grown on 0.01 mM SA, despite increases in the ascorbate and dehydroascorbate levels. However, on 0.1 mM SA, the ascorbate redox-ratio decreased by more than 40% due to a 300% increase in dehydroascorbate. The glutathione redox-ratio was maintained in the shoots of plants grown on either SA concentration, despite increase in the glutathione level (Dat *et al.*, 2000). In cucumber hypocotyls, SA significantly increased the activity of these enzymes in control and chilled tissue, while having no effect on the activities in radicle tissues (Kang and Saltveit, 2002). The treatment of *Ficus carica* leaves with SA by submerging the leaves into 5 mM SA solution did not cause any significant increase in the mRNA level of peroxidase (Kim *et al.*, 2003a). However, it should be mentioned that although the total activity did not increase substantially in maize treated with SA, a new peroxidase isoform was detected (Janda *et al.*, 1999).

MDHAR maintains reduced pools of ascorbate by recycling the oxidized form of ascorbate. The screening of a *Brassica campestris* cDNA library led to the identification of an MDHAR cDNA (BcMdhar) which encodes a polypeptide containing 434 amino acids. This polypeptide possesses domains characteristic of FAD- and NAD(P)H-binding proteins (Yoon *et al.*, 2004), and shows a high level of identity to the cytosolic MDHAR of rice, pea and tomato, but does not possess an N-terminal leader sequence, suggesting that it encodes a cytosolic form of MDHAR. The level of BcMdhar mRNA increased in response to oxidative stress invoked by H₂O₂, SA, paraquat and ozone.

Glutathione peroxidases are also enzymes which protect cells against the oxidative damage generated by ROS. Up to now seven related proteins have been identified in *Arabidopsis thaliana* plants, and the expression of the one showing the strongest response to abiotic stress was also affected by several plant hormones, including SA (Milla *et al.*, 2003). Along with plasmalemmal redox systems, cell-wall peroxidase is involved in the production of superoxide and H₂O₂. Under stress conditions, some soluble peroxidase isoforms are easily secreted into the apoplast. Various membranotropic compounds, SA in particular, can also induce this process. Mobile peroxidase forms are thought to induce the plant defence response (Minibaeva *et al.*, 2003).

Glutathione S-transferases (GST) form a large family of non-photosynthetic enzymes known to function in the detoxification of xenobiotics. The effect of SA is ambiguous in the case of the GST enzyme. The *in vitro* activity of the enzyme is inhibited non-competitively by SA (Watahiki *et al.*, 1995), which, however, stimulates its expression. PEG and

heavy metals rapidly induced the *osgstu4* and *osgstu3* genes in rice seedling roots (Moons, 2003). *Osgstu4* and *osgstu3* were also induced in roots by hypoxic stress but not by cold nor heat shock. Salt stress and ABA also induced *osgstu3* in rice roots, whereas *osgstu4* exhibited late salt stress and no ABA response. SA, JA and the auxin naphthalene acetic acid triggered *osgstu4* and *osgstu3* expression. *Osgstu4* and *osgstu3* were rapidly and markedly induced by the antioxidant dithiothreitol and by the strong oxidant H_2O_2 , suggesting that redox perturbations and ROS are involved in their stress response regulation. Similarly, SA caused an increase in the expression of the *Gnt35* gene coding for GST in tobacco cells. Recently a novel, low temperature-regulated, *Solanum commersonii* GST gene (*Scgst1*) was cloned and characterized from a cold acclimated wild potato species and the level of its transcription was studied in freezing-tolerant and sensitive *Solanum* genotypes (Seppanen *et al.*, 2000). Increased GST enzyme activity was observed in *S. commersonii* and SH9A after 2 days of cold acclimation, whereas the activity declined in *S. tuberosum* during the same period. ROS were associated with the early steps of *Scgst1* regulation since a strong mRNA signal was detected in plants treated with H_2O_2 and SA. Under experimental conditions where the formation of ROS is known to accelerate, such as excessive light at low temperature, a significant accumulation of the transcript was observed in *S. commersonii*. Under similar experimental conditions, the *Scgst1* transcript did not accumulate in freezing-sensitive *S. tuberosum* though a single copy of the *Scgst1* sequence was present in both species. The abundance of *Scgst1* transcript correlated well with the freezing tolerance of the parental lines and the somatic hybrid SH9A. However, further studies of potato lines derived by selfing the somatic hybrid revealed a more complex relationship between freezing tolerance and *Scgst1* expression level. A SA-responsive component (*as-1*) was found in the promoter region of some GST genes, which is activated not only by SA but also by auxin and methyl JA via reactive oxygen forms (Garretón *et al.*, 2002).

3.3 Role of alternative oxidases

One of the best known roles of endogenous SA is its role in heat production, which is due to the enhanced activity of the cyanide-resistant or alternative respiration chain (Raskin *et al.*, 1987). An increase in the alternative pathway can also be observed during chilling stress (Moynihan *et al.*, 1995). It was assumed that the increased capacity to produce respiratory heat after exposure to chilling temperatures might contribute to the cold-acclimation process. A correlation was also found between the activity of the alternative respiratory pathway and the chilling tolerance of maize lines

(Vandeventer, 1985; Luxova and Gasparikova, 1999). On the other hand, studies of the electron partitioning between the cytochrome and the alternative respiratory pathways during chilling recovery, using the oxygen isotope fractionation technique, revealed that electron partitioning to the alternative pathway was greater in the chilling-sensitive maize line, which suffered greater stress, so it was suggested that the increased activity of the alternative pathway is not related to the tolerance of the plant to chilling (Ribas-Carbo *et al.*, 2000). The existence of multiple pathways to regulate the expression of the alternative oxidase genes encoding the alternative oxidase was recently demonstrated in soybean (Djajanegara *et al.*, 2002). The Aox1 gene is specifically induced by a variety of stress and metabolic conditions, including SA, via at least two independent signal transduction pathways. Similar results were found when using the mRNA differential display technique; seven cDNAs were isolated that were rapidly induced when cultured tobacco (*Nicotiana tabacum*) cells were treated with antimycin A (Maxwell *et al.*, 2002). All the cDNAs, as well as Aox1, were found to be strongly induced by H₂O₂ and SA. The antimycin, H₂O₂ or SA treatment of tobacco cells caused a rapid rise in intracellular ROS accumulation but if it was prevented by antioxidant treatment, gene induction was inhibited. Besides antimycin, both H₂O₂ and SA were found to disrupt normal mitochondrial function, resulting in decreased rates of electron transport and a lowering of cellular ATP levels. These findings suggest that the mitochondrion may play an important role in conveying intracellular stress signals to the nucleus, leading to alterations in gene expression.

3.4 Protein kinases

Reversible protein phosphorylation/dephosphorylation plays an important role in signalling adaptive responses to several types of stress (Bassett, 2001). The first step in signal relay is the perception of a chemical or physical signal, such as a change in temperature or light. One type of sensor commonly used to initiate a response to the signal is a receptor protein kinase (RPK). Plants utilize two types of RPKs: histidine-phosphorylating types, such as the ethylene receptor, and serine/threonine-phosphorylating types, such as the brassinosteroid receptor. A receptor-like protein kinase gene (Ppsrk11) was isolated from a peach (*Prunus persica* L. Batsch.) bark cDNA library prepared with RNAs isolated from bark collected in December under cold acclimation conditions (Bassett *et al.*, 2005). Because peach is a self-compatible species and the gene was originally identified in December bark tissue, it can be assumed that the expression of this gene might be responsive to environmental stresses related to winter, i.e. low temperatures,

short-day photoperiod or water limitation. This gene is related to the S-locus family of receptor protein kinases (SRKs), which belongs to a group of serine/threonine-phosphorylating type RPKs. In bark tissues, Ppsrk11 was induced by water deficit treatment, and repressed by short-day photoperiods, while it showed no response to cold treatment. There was also an increase in Ppsrk11 mRNA in the roots in response to water deficit. The addition of 25mM SA prevented the decline in Ppsrk11, 12 h after wounding in fruit, but did not further induce the mRNA in samples taken earlier. The quantity of Ppsrk11 mRNA rapidly decreased in fruit after 10-min exposure to UV-C radiation, followed by a return to normal levels within 1.5 h. These experiments indicate that Ppsrk11 is negatively regulated by light and positively influenced by SA treatment in fruit and by water stress in bark and roots.

In plants, two classes of stress-activated protein kinases, mitogen-activated protein kinases (MAPKs) and calcium-dependent protein kinases (CDPKs) have so far been reported to integrate multiple environmental stresses and undergo rapid biochemical activation upon exposure to biotic and abiotic stimulation. The MAPK signal transduction cascades are routes through which eukaryotic cells deliver extracellular messages to the cytosol and nucleus (Morris, 2001). These signalling pathways direct cell division, cellular differentiation, metabolism, and both biotic and abiotic stress responses. In plants, MAPKs and the upstream components of the cascades are represented by multigene families, organized into different pathways which are stimulated and interact in complex ways. In particular, it was proposed that two MAPKs, tobacco SA-induced protein kinase (SIPK) and wound-induced protein kinase (WIPK), and their respective orthologue in other plant species functioned as central convergence points in stress signalling (Zhang and Klessig, 1997; 1998; Jonak *et al.*, 2002). Plants normally respond to wounding with enhanced levels of JA, which in turn is involved in the induction of wound-induced genes (Farmer and Ryan, 1992). However, SA also increased in wounded leaves (Seo *et al.*, 1995b). It was assumed that WIPK may regulate JA synthesis by the phosphorylation of cytoplasmic phospholipase A2, and that JA may suppress SA synthesis. The opposite effects of SA and JA have also been reported for the regulation of a wound-inducible ipomoelin gene isolated from sweet potato (*Ipomoea batatas*). Besides mechanical wounding, ethylene and methyl JA were identified as signal transducers leading to the accumulation of ipomoelin mRNA. However, treatment with SA reduced the production of mRNA, further supporting the involvement of the octadecanoid pathway in the signal transduction of wounding in sweet potato. The application of the protein phosphatase inhibitor okadaic acid, a calcium ion chelator or channel blockers also blocked the methyl JA- or ethylene-induced accumulation of

ipomoelin mRNA, indicating that the activation of this gene by both MeJA and ethylene proceeded via dephosphorylated proteins and that the calcium ion was also involved in the activation process (Chen *et al.*, 2003). Another example of the opposite effect of SA and JA has been reported in sweet potato: SA, as an inhibitor of the octadecanoid pathway, strongly suppressed the promoter function of sporamin, a tuberous storage protein stimulated by wounding and methyl JA treatments (Wang *et al.*, 2002). Nevertheless, there are also genes where the effect of SA and JA is the same, as it was reported for the expression of resveratrol synthase genes, which can be induced by biotic and abiotic factors, such as UV light, wounding or paraquat, and by stress hormones, such as ethylene, JA and SA, but not by ABA (Chung *et al.*, 2001; 2003).

Two protein kinases with molecular masses of 48 and 40 kD are activated in tobacco cells exposed to NaCl (Hoyos and Zhang, 2000). The 48-kD protein kinase was identified as SIPK. The activation of the 40-kD protein kinase is rapid and dose-dependent. Other osmolytes such as Pro and sorbitol activate these two kinases with similar kinetics. The activation of 40-kD protein kinase is specific for hyperosmotic stress, as hypotonic stress does not activate it. Therefore, this 40-kD kinase was named HOSAK (high osmotic stress-activated kinase). HOSAK is a Ca^{2+} -independent kinase and uses myelin basic protein and histone equally well as substrates. The kinase inhibitor rapidly activates HOSAK in tobacco cells, implicating a dephosphorylation mechanism for HOSAK activation. The activation of both SIPK and HOSAK by high osmotic stress is Ca^{2+} - and ABA-independent. Furthermore, a mutation in the Ca^{2+} sensor-encoding SOS3 locus, which leads to a salt overly sensitive phenotype does not affect the activation of either kinase in *Arabidopsis* seedlings. These results suggest that SIPK and 40-kD HOSAK are two components in a Ca^{2+} - and ABA-independent pathway that may lead to plant adaptation to hyperosmotic stress. It was also shown that a rice gene encoding an MAPK kinase, OsEDR1, is constitutively expressed in seedling leaves and is up-regulated within a few minutes upon wounding, or treatment with JA, SA, ethylene, ABA or H_2O_2 (Kim *et al.*, 2003b). Protein phosphatase inhibitors, the fungal elicitor chitosan, drought, high salt and sugar, and heavy metals also dramatically induce its expression. OsEDR1 expression was altered by the co-application of JA, SA and ethylene, and required *de novo* synthesized protein factor(s) in its transient regulation. Using an *in vivo* system it was shown that OsEDR1 responds to changes in temperature and environmental pollutants. The expression of OsEDR1 varied significantly in vegetative and reproductive tissues, suggesting a role for OsEDR1 in defense/stress signalling pathways and development.

Two novel rice (*Oryza sativa* L.) MAPKs, OsMSRMK3 (multiple stress responsive) and OsWJUMK1 (wound- and JA-uninducible), which most likely exist as single copy genes in the genome, were recently isolated (Agrawal *et al.*, 2003). The steady state mRNA analysis of these MAPKs, which are constitutively expressed in the leaves of two-week-old seedlings, revealed that OsMSRMK3 was up-regulated upon wounding, JA, SA, ethylene, ABA, H₂O₂, protein phosphatase inhibitors, chitosan, high salt/sugar, and heavy metals, whereas OsWJUMK1 was not induced by either wounding, JA or SA, and showed up-regulation only as the result of H₂O₂, heavy metals and cold stress. Moreover, these MAPKs were developmentally regulated. These results strongly suggest a role for OsMSRMK3 and OsWJUMK1 in both stress-signalling pathways and development in rice.

Calcium may control the activity of plant protein kinases through indirect or direct interaction with the enzymes. Indirect interactions involve calmodulin, a calcium-binding protein. Six *Arabidopsis* genes designated as AtSR1-6, related to a tobacco early ethylene-responsive gene, encoding a calmodulin-binding protein, were also shown to be rapidly and differentially induced by environmental signals such as temperature extremes, UV-B, salt and wounding, by hormones such as ethylene and ABA and by signal molecules such as methyl JA, H₂O₂ and SA (Yang and Poovaiah, 2002). AtSR1 targets the nucleus and specifically recognizes a novel 6-bp CGCG box (A/C/G)CGCG(G/T/C). Multiple CGCG cis-elements are found in promoters of genes such as those involved in ethylene signalling, ABA signalling and light signal perception. These results suggest that the AtSR gene family encodes a family of calmodulin-binding/DNA-binding proteins involved in multiple signal transduction pathways in plants. The direct interaction of calcium with enzymes implicates a multi-family protein referred to as calcium-dependent protein kinases (CDPKs), which fall into the serine/threonine class of protein kinases found mainly in plants and in some protozoans (Harmon *et al.*, 2001). CDPKs from many species have been shown to be involved in stress responses. Cold treatment has previously been shown to enhance the activity of a rice CDPK (Martin and Busconi, 2001), while the over-expression of the rice CDPK, OsCDPK7, confers cold and salt tolerance in the transgenic tissues (Saijo *et al.*, 2000). Transcripts of a previously identified tomato CDPK, LeCDPK1, increase transiently in plants subjected to mechanical wounding, both at the wound site and in non-wounded leaves (Chico *et al.*, 2002). The increase observed in LeCDPK1 mRNA upon wounding correlates with an increase in the activity of a soluble CDPK detected in extracts of tomato leaves. CDPK mRNA accumulation has been shown previously to be induced by GA, ABA, cytokinin (Yoon *et al.*, 1999), indole-3-acetic acid (Davletova *et al.*, 2001), and brassinolide

(Yang and Komatsu, 2000). The *Capsicum annuum* calcium-dependent protein kinase 3 (CaCDPK3), localized in the cytosol in chili pepper protoplasts, was rapidly induced in response to various osmotic stress factors and exogenous ABA application in pepper leaves. CaCDPK3 RNA expression was also induced by an incompatible pathogen and by plant defence-related chemicals such as ethephon, SA and JA. It is assumed that CaCDPK3 is implicated in biotic and abiotic stresses in pepper plants (Chung *et al.*, 2004).

A cDNA clone (LeCRK1), encoding a novel isoform of calcium-dependent protein kinase (CDPK), was isolated by screening a tomato (*Lycopersicon esculentum*) cDNA library (Leclercq *et al.*, 2005). The protein derived from the full-length sequence indicated that it belongs to the family of CDPK-related kinases (CRKs) and the predicted amino acid sequence shows a modular organization of the protein, consisting of various characteristic domains. The kinase domain of LeCRK1 shows a high degree of similarity with the catalytic domain of CDPKs. In contrast to canonical members of the family, LeCRK1 has a degenerate sequence in the C-terminal calmodulin-like domain. LeCRK1 protein was shown to be a functional kinase, but, consistent with the lack of calcium-binding activity, its autophosphorylation activity did not require calcium. LeCRK1 harbours an amphiphilic amino acid region, revealed by *in vitro* assay to be a functional calmodulin-binding site. The native protein is anchored to the plasma membrane by acylated residues. Expression studies revealed a significant accumulation of LeCRK1 transcripts during fruit ripening, although transcripts were also detected in stem, leaf and flower. LeCRK1 transcript levels are low in unstressed leaves, but increase in response to wounding and cold treatment. Gene expression was slightly induced by ethylene and by spraying the leaves with a 4 mM solution of SA, and by mechanical wounding or cold treatment.

ROS accumulating due to unfavourable changes in environmental conditions may also trigger the activation of signalling cascades such as the mitogen-activated protein kinase cascade and the accumulation of plant hormones, such as JA, SA and ethylene. It was shown that in *Arabidopsis* plants ozone treatment caused a transient activation of 43 and 45 kDa MAPKs, identified as AtMPK3 and AtMPK6, via the generation of ROS in the apoplast (Ahlfors *et al.*, 2004). The initial AtMPK3 and AtMPK6 activation in response to ozone was not dependent on ethylene signalling, though ethylene is likely to have secondary effects on AtMPK3 and AtMPK6 function, whereas functional SA signalling was needed for full-level AtMPK3 activation by ozone. It was also shown that AtMPK3, but not AtMPK6, responded transcriptionally and translationally during ozone exposure. The activated AtMPK3 and AtMPK6 are translocated to the

nucleus during the early stages of ozone treatment. The use of ozone to induce apoplastic ROS formation offers a non-invasive *in planta* system amenable to reverse genetics that can be used for the study of stress-responsive MAPK signalling in plants (Ahlfors *et al.*, 2004). In another study, the regulation of the MAP kinase gene (OsMAPK2) expression was investigated in rice under metal stress conditions (Hung *et al.*, 2005). The accumulation of OsMAPK2 transcripts was enhanced by copper and H₂O₂ in rice root-tip cells. Glutathione, calcium chelator, plasma membrane calcium channel blocker and the protein phosphatase inhibitor, cantharidin inhibited copper-induced OsMAPK2 gene activation. These results support the idea that the stimulation of OsMAPK2 transcript accumulation by copper in rice roots may operate through an intracellular signalling cascade mediated by ROS, extracellular calcium ions and cantharidin-sensitive protein phosphatase.

As shown in tobacco plants, ozone may also induce rapid activation of SIPK. Transgenic manipulation has previously shown that the overexpression of SIPK leads to enhanced ozone-induced lesion formation with the concomitant accumulation of ROS. Ozone treatment strongly induced ethylene formation in sensitive SIPK-overexpressing plants at ozone concentrations that failed to elicit stress ethylene release in wild-type plants. By contrast, SIPK-overexpressing plants displayed no ozone-induced SA accumulation, whereas wild-type plants accumulated SA upon ozone exposure. The epistatic analysis of SIPK-overexpressing function suggests that the ozone-induced cell death observed in SIPK-overexpressing plants is either independent, or upstream, of SA accumulation (Samuel *et al.*, 2005).

4. RELATIONSHIP BETWEEN BIOTIC AND ABIOTIC STRESS FACTORS

It was established by Pastori and Foyer (2002) that the mechanisms of abiotic and biotic stress resistance have many points in common. The enhanced resistance of barley (*Hordeum vulgare* L.) against barley powdery mildew was induced by abiotic stresses, such as osmotic or proton stresses (Wiese *et al.*, 2004). Another interesting example of common pathways for the regulation of protective mechanisms against biotic and abiotic stresses was recently shown using the *edr1* (enhanced disease resistance 1) *Arabidopsis* mutant, which displays enhanced stress responses and spontaneous necrotic lesions under drought conditions in the absence of pathogens, suggesting that EDR1, which encodes a CTR-1 like kinase, is also involved in stress response signalling and cell death regulation. Double

mutant analyses showed that the *edr1*-mediated growth inhibition and cell death phenotypes are also SA-dependent (Tang *et al.*, 2005).

Despite these similarities, however, there are also differences, raising the question of how the two types of responses are integrated if plants are exposed simultaneously to both biotic and abiotic stress (Mittler, 2002). SA and ROS play a key role in both processes.

An antifungal protein (GtAFP1) showing antimicrobial activity against phytopathogenic fungi was recently purified from leaves of *Gentiana triflora* (Kiba *et al.*, 2005). The deduced amino acid sequence of the cDNA of the corresponding gene, GtAFP1, showed 94, 75, 72 and 63% amino acid identity with peroxylredoxin Q from *Populus balsamifera* x *P. deltoides* subsp. *trichocarpa*, *Sedum lineare*, *Suaeda maritima* and *Arabidopsis thaliana*, respectively. It is suggested the GtAFP1 gene is present in the genome in one to two copies and was expressed in leaves, roots and stems. The expression of GtAFP1 was induced by treatment with SA, but not by methyl JA. Recombinant GtAFP1 protein showed not only antifungal activity but also thioredoxin-dependent peroxidase activity. The overexpression of GtAFP1 in tobacco plants improved tolerance not only against fungal diseases but also against oxidative stress. These results indicate that GtAFP1 might act as a disease and oxidative stress defensive gene in plants and could be useful for engineering stress-resistant plants.

The recent characterization of a number of genes suggested that ubiquitin-mediated protein degradation has a role in plant defence responses. The 26S proteasome involved in the degradation of proteins covalently modified with polyubiquitin consists of the 20S proteasome and the 19S regulatory complex. The NbPAF gene encoding the alpha6 subunit of the 20S proteasome was identified from *Nicotiana benthamiana* (Kim *et al.*, 2003c). NbPAF mRNA was detected abundantly in flowers and weakly in roots and stems, but it was almost undetectable in mature leaves. In response to stresses, the accumulation of NbPAF mRNA was stimulated by methyl JA, NaCl and SA, but not by ABA or cold treatment in leaves. Recently two cDNAs (NtUBA1 and NtUBA2) encoding ubiquitin-activating enzyme from *Nicotiana tabacum* cv. BY-2 were isolated (Takizawa *et al.*, 2005). These enzymes and the corresponding transcripts were up-regulated by infection with tobacco mosaic virus and tomato mosaic virus, and to a lesser extent by cucumber mosaic virus. Furthermore, they were also up-regulated by wounding stress, and by the plant hormones SA, JA and the ethylene precursor, ACC. These findings support the idea that the ubiquitin-proteasome system plays a role in plant disease defences.

Ten peroxidase genes (designated TmPRX1 to TmPRX10) were recently isolated and characterized from a cDNA library constructed from the leaf epidermis of diploid wheat (*Triticum monococcum*) infected with the

powdery mildew fungus (*Blumeria graminis* f. sp. *tritici*) (Liu *et al.*, 2005). Consistent with its abundance in the EST collection, TmPRX1 expression showed the highest induction during pathogen attack and fluctuated in response to the fungal parasitic stages. TmPRX1 to TmPRX6 were expressed predominantly in mesophyll cells, whereas TmPRX7 to TmPRX10, which feature a putative C-terminal propeptide, were detectable mainly in epidermal cells. The differential expression profiles of the TmPRXs after abiotic stresses and signal molecule treatments were used to dissect the potential role of these peroxidases in multiple stress and defence pathways.

Transcription of the pepper defensin CADEF1 gene isolated from a cDNA library constructed from pepper leaves infected with an avirulent strain of *Xanthomonas campestris* pv. *vesicatoria* was induced earlier and more strongly by *X. campestris* pv. *vesicatoria* infection in the incompatible than in the compatible interaction. CADEF1 mRNA was constitutively expressed in the stem, roots and green fruit of pepper. Transcripts of CADEF1 gene accumulated to a great extent in pepper leaf tissues treated with SA, methyl JA, ABA, H₂O₂, benzothiadiazole and D,L- β -amino-n-butyric acid. *In situ* hybridization results revealed that CADEF1 mRNA was localized in the phloem areas of vascular bundles in leaf tissues treated with exogenous SA, methyl JA and ABA. A strong accumulation of CADEF1 mRNA occurred in pepper leaves in response to wounding, high salinity and drought stress. These results suggest that bacterial pathogen infection, abiotic elicitors and certain environmental stresses may play a significant role in the signal transduction pathway for CADEF1 gene expression (Do *et al.*, 2004).

An *Arabidopsis* mutant, designated *adr1* (activated disease resistance1), constitutively expressed SA-dependent defence genes and was resistant to a broad spectrum of virulent pathogens (Grant *et al.*, 2003). ADR1 was found to encode a coiled-coil/nucleotide-binding site/leucine-rich repeat protein, which possessed domains of homology with serine/threonine protein kinases. It was also shown that either the constitutive or conditional enhanced expression of ADR1 conferred significant drought tolerance. This was not a general feature of defence-related mutants because *cir* (constitutive induced resistance)1, *cir2* and *cpr* (constitutive expressor of PR genes)1, which constitutively express systemic acquired resistance, failed to exhibit this phenotype. The increased drought tolerance of *adr1* was not indicative of cross-tolerance, because it did not show an increase in tolerance of other stress factors, they showed increased sensitivity to heat and salinity stress. Furthermore, neither hemizygous nor homozygous *adr1* plants exhibited either increased tolerance or sensitivity to heavy metal stress. In a similar fashion, *adr1* plants failed to exhibit any significant tolerance to

freezing (Chini *et al.*, 2004). Similar observations were made when a P4-chitinase genomic sequence was isolated from a bean genomic library using a P4-ch cDNA. Various stress conditions, such as wounding, SA and NaCl treatments, heat and cold stress were applied to bean (*Phaseolus vulgaris*) plants. Whereas wounding, NaCl treatment and cold stress were ineffective, the transcription of P4-chitinase mRNA was induced by SA treatment and, surprisingly, in response to heat stress (Margispinheiro *et al.*, 1994). Hence, *adr1*-activated signalling may antagonise some stress responses. The Northern analysis of abiotic marker genes revealed that the dehydration-responsive element DREB2A was expressed in *adr1* plant lines, but not DREB1A, RD(response to dehydration)29A or RD22. Furthermore, DREB2A expression was SA-dependent but NPR (non-expressor of PR genes)1-independent. In the double mutants *adr1/ADR1 NahG*, *adr1/ADR1 eds* (enhanced disease susceptibility)1 and *adr1/ADR1 abi1* (ABA insensitive), drought tolerance was significantly reduced. The microarray analysis of plants containing a conditional *adr1* allele demonstrated that a significant number of the up-regulated genes were previously implicated in responses to dehydration (Chini *et al.*, 2004).

5. CONCLUSIONS

It is clear from the above results, that SA could be a very promising compound for the reduction of the abiotic stress sensitivity of crops, since under certain conditions it has been found to mitigate the damaging effects of various stress factors in numerous plant species (Figure 1).

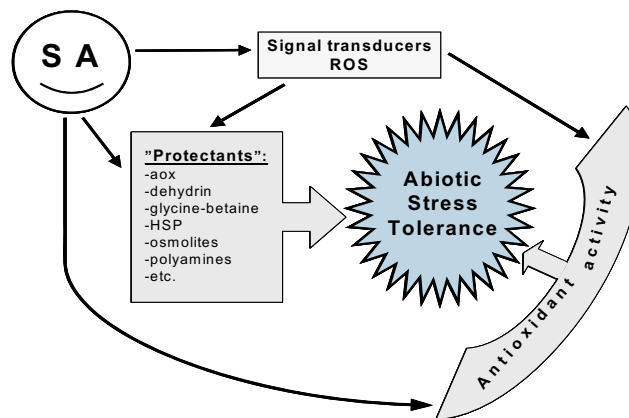

Figure 1. Schematic model of the action of SA on the induction of abiotic stress tolerance. For details see the text.

However, a number of questions remain unanswered at both the theoretical and the practical level. A similar effect is exerted by many related compounds involved in the synthesis of SA, whether artificial or naturally occurring in plants. This raises the question of whether SA is the only, or the most important key molecule. In certain cases contradictory results are obtained in investigations on the effect of exogenous SA application and that of endogenous SA levels. It is not yet clear whether the effect of exogenous SA is direct or whether it is connected with that of endogenous SA. SA is part of an extremely complex signal transduction network. The clarification of these questions could bring us closer to an understanding of the control mechanism.

6. ACKNOWLEDGMENTS

The authors wish to thank Barbara Harasztos for revising the English. Tibor Janda is a grantee of the János Bolyai Scholarship. This work was supported by the Hungarian National Scientific Research Foundation (OTKA T37195; T046150).

7. REFERENCES

- Agarwal, S., Sairam, R. K., Srivastava, G. C., Tyagi, A., and Meena, R. C., 2005. Role of ABA, salicylic acid, calcium and hydrogen peroxide on antioxidant enzymes induction in wheat seedlings. *Plant Sci.*, **169**: 559-570.
- Agrawal, G. K., Agrawal, S. K., Shibato, J., Iwahashi, H., and Rakwal, R., 2003. Novel rice MAP kinases OsMSRMK3 and OsWJUMK1 involved in encountering diverse environmental stresses and developmental regulation. *Biochem Biophys. Res. Com.*, **300**: 775-783.
- Ahlfors, R., Macioszek, V., Rudd, J., Brosche, M., Schlichting, R., Scheel, D., and Kangasjarvi, J., 2004. Stress hormone-independent activation and nuclear translocation of mitogen-activated protein kinases in *Arabidopsis thaliana* during ozone exposure. *Plant J.*, **40**: 512-522.
- Ananieva, E. A., Alexieva, V. S., and Popova, L. P., 2002. Treatment with salicylic acid decreases the effects of paraquat on photosynthesis. *J. Plant Physiol.*, **159**: 685-693.
- Anderson, M. D., Chen, Z., and Klessig, D. F., 1998. Possible involvement of lipid peroxidation in salicylic acid-mediated induction of PR-1 gene expression. *Phytochem.*, **47**: 555-566.
- Azevedo, H., Lino-Neto, T., and Tavares, R. M., 2004. Salicylic acid up-regulates the expression of chloroplastic Cu,Zn-superoxide dismutase in needles of maritime pine (*Pinus pinaster* Ait.). *Ann. For. Sci.*, **61**: 847-850.
- Baier, M., Kandlbinder, A., Golldack, D., and Dietz, K. J., 2005. Oxidative stress and ozone: perception, signalling and response. *Plant Cell Environ.*, **28**: 1012-1020.

- Bandurska, H., and Stroinski, A. 2005. The effect of salicylic acid on barley response to water deficit. *Acta Physiol. Plant.*, **27**: 379-386.
- Ball, L., Accotto, G. P., Bechtold, U., Creissen, G., Funck, D., Jimenez, A., Kular, B., Leyland, N., Mejia-Carranza, J., Reynolds, H., Karpinski, S., and Mullineaux, P. M., 2004. Evidence for a direct link between glutathione biosynthesis and stress defense gene expression in *Arabidopsis*. *Plant Cell*, **16**: 2448-2462.
- Bassett, C. L., 2001. The molecular biology of plant hormone reception. *Hort. Rev.*, **26**: 49–84.
- Bassett, C. L., Nickerson, M. L., Farrell, R. E., Artlip, T. S., El Ghaouth, A., Wilson, C.L., and Wisniewski, M. E., 2005. Characterization of an S-locus receptor protein kinase-like gene from peach. *Tree Physiol.*, **25**: 403-411.
- Bernard, F., Shaker-Bazarnov, H., and Kaviani, B., 2002. Effects of salicylic acid on cold preservation and cryopreservation of encapsulated embryonic axes of Persian lilac (*Melia azedarach* L.). *Euphytica*, **123**: 85-88.
- Black, V. J., Black, C. R., Roberts, J. A., and Stewart, C. A., 2000. Impact of ozone on the reproductive development of plants. *New Phytol.*, **147**: 421–447.
- Borsani O., Valpuesta V., and Botella M. A. 2001. Evidence for a role of salicylic acid in the oxidative damage generated by NaCl and osmotic stress in *Arabidopsis* seedlings. *Plant Physiol.*, **126**: 1024-1030.
- Bowler, C., and Fluhr, R., 2000. The role of calcium and activated oxygens as signals for controlling cross-tolerance. *Trends Plant Sci.*, **5**: 241–246.
- Brune, A., Urbach, W., and Dietz, K.-J. 1995. Differential toxicity of heavy metals is partly related to a loss of preferential extraplasmic compartmentation: a comparison of Cd-, Mo-, Ni- and Zn-stress. *New Phytol.*, **129**: 404–409
- Chai, T. Y., Zhang, Y. X., 1999. Gene expression analysis of a proline-rich protein from bean under biotic and abiotic stress. *Acta Bot. Sin.*, **41**: 111-113.
- Chakraborty, U., and Tongden, C., 2005. Evaluation of heat acclimation and salicylic acid treatments as potent inducers of thermotolerance in *Cicer arietinum* L. *Curr. Sci.*, **89**: 384-389.
- Chen, Z., Silva, H., and Klessig, D. F. 1993a. Active oxygen species in the induction of plant systemic acquired resistance by salicylic acid. *Science*, **262**: 1883-1886.
- Chen, Z., Ricigliano, J. R., and Klessig, D. F. 1993b. Purification and characterization of a soluble salicylic acid binding protein from tobacco. *Proc. Natl. Acad. Sci. USA*, **90**: 9533-9537.
- Chen, Z., Iyer, S., Caplan, A., Klessig, D. F., and Fan, B. 1997. Differential accumulation of salicylic acid and salicylic acid-sensitive catalase in different rice tissues. *Plant Physiol.*, **114**: 193-201.
- Chen, Y. C., Tseng, B. W., Huang, Y. L., Liu, Y. C., and Jeng, S. T., 2003. Expression of the ipomoelin gene from sweet potato is regulated by dephosphorylated proteins, calcium ion and ethylene. *Plant Cell Environ.*, **26**: 1373-1383.
- Chen, B. J., Wang, Y., Hu, Y. L., Wu, Q., and Lin, Z. P., 2005. Cloning and characterization of a drought-inducible MYB gene from *Boea crassifolia*. *Plant Sci.*, **168**: 493-500.
- Chico, J. M., Raíces, M., Tellez-Iñón, M. T., and Ulloa, R. M., 2002. A calcium-dependent protein kinase is systemically induced upon wounding in tomato plants. *Plant Physiol.*, **128**: 256–270.
- Chini, A., Grant, J. J., Seki, M., Shinozaki, K., and Loake, G. J., 2004. Drought tolerance established by enhanced expression of the CC-NBS-LRR gene, ADR1, requires salicylic acid, EDS1 and ABI1. *Plant J.*, **38**: 810-822.
- Chong, J., Pierrel, M.-A., Atanassova, R., Werck-Reichhart, D., Fritig, B., and Saindrenan, P., 2001. Free and conjugated benzoic acid in tobacco plants and cell cultures. Induced

- accumulation upon elicitation of defense responses and role as salicylic acid precursors. *Plant Physiol.*, **125**: 318–328.
- Chung, I. M., Park, M. R., Rehman, S., and Yun, S. J., 2001. Tissue specific and inducible expression of resveratrol synthase gene in peanut plants. *Mol. Cells*, **12**: 353–359.
- Chung, I. M., Park, M. R., Chun, J. C., and Yun, S. J., 2003. Resveratrol accumulation and resveratrol synthase gene expression in response to abiotic stresses and hormones in peanut plants. *Plant Sci.*, **164**: 103–109.
- Chung, E., Park, J. M., Oh, S. K., Joung, Y. H., Lee, S., and Choi, D., 2004. Molecular and biochemical characterization of the *Capsicum annuum* calcium-dependent protein kinase 3 (CaCDPK3) gene induced by abiotic and biotic stresses. *Planta*, **220**: 286–295.
- Clarke, S. M., Mur, L. A. J., Wood, J. E., and Scott, I. M., 2004. Salicylic acid dependent signaling promotes basal thermotolerance but is not essential for acquired thermotolerance in *Arabidopsis thaliana*. *Plant J.*, **38**: 432–447.
- Cleland, C. F., 1974. Isolation of flower-inducing and flower-inhibitory factors from aphid honeydew. *Plant Physiol.*, **54**: 899–903.
- Cleland, C. F. and Ajami, A., 1974. Identification of the flower-inducing factor isolated from aphid honeydew as being salicylic acid. *Plant Physiol.*, **54**: 904–906.
- Conklin, P. L., and Last, R. L., 1995. Differential accumulation of antioxidant mRNAs in *Arabidopsis thaliana* exposed to ozone. *Plant Physiol.*, **109**, 203–212.
- Conklin, P. L., and Barth C., 2004. Ascorbic acid, a familiar small molecule intertwined in the response of plants to ozone, pathogens and the onset of senescence. *Plant Cell Environ.*, **27**: 959–970.
- Conrath U., Chen Z., Ricigliano J.R., and Klessig D.F. 1995. Two inducers of plant defense responses, 2,6-dichloroisonicotinic acid and salicylic acid, inhibit catalase activity in tobacco. *Proc. Natl. Acad. Sci. USA*, **92**: 7143–7147.
- Cronje, M. J., and Bornman, L., 1999. Salicylic acid influences Hsp70/Hsc70 expression in *Lycopersicon esculentum*: Dose- and time-dependent induction or potentiation. *Biochem. Biophys. Res. Com.*, **265**: 422–427.
- Dat, J. F., Lopez-Delgado, H., Foyer, C. H., and Scott, I. M., 1998a. Parallel changes in H₂O₂ and catalase during thermotolerance induced by salicylic acid or heat acclimation in mustard seedlings. *Plant Physiol.*, **116**: 1351–1357.
- Dat, J. F., Foyer, C. H., and Scott, I. M., 1998b. Changes in salicylic acid and antioxidants during induced thermotolerance in mustard seedlings. *Plant Physiol.*, **118**: 1455–1461.
- Dat, J. F., Lopez-Delgado, H., Foyer, C. H., and Scott, I. M., 2000. Effects of salicylic acid on oxidative stress and thermotolerance in tobacco. *J. Plant Physiol.*, **156**: 659–665.
- Davletova, S., Mészáros, T., Miskolczi P., Oberschall, A., Török, K., Magyar, Z., Dudits, D., and Deák, M., 2001. Auxin and heat shock activation of a novel member of the calmodulin-like domain protein kinase gene family in cultured alfalfa cells. *J. Exp. Bot.*, **52**: 215–221.
- Dean, J. V., Shah, R. P., and Mohammed, L. A., 2003. Formation and localization of salicylic acid glucose conjugates in soybean cell suspension cultures. *Physiol. Plant.*, **118**: 328–336.
- DeKock, P. C., Grabowsky, F. B., and Innes, A. M., 1974. The effect of salicylic acid on the growth of *Lemna gibba*. *Ann. Bot.*, **38**: 903–908.
- Djajaneegara, I., Finnegan, P. M., Mathieu, C., McCabe, T., Whelan, J., and Day, D. A., 2002. Regulation of alternative oxidase gene expression in soybean. *Plant Mol. Biol.*, **50**: 735–742.
- Do, H. M., Lee, S. C., Jung, H. W., Sohn, K. H., and Hwang, B. K., 2004. Differential expression and in situ localization of a pepper defensin (CADEF1) gene in response to

- pathogen infection, abiotic elicitors and environmental stresses in *Capsicum annuum*. *Plant Sci.*, **166**: 1297-1305.
- Duan, H., and Schuler, M. A., 2005. Differential expression and evolution of the *Arabidopsis* CYP86A subfamily. *Plant Physiol.*, **137**: 1067-1081.
- Durner, J., and Klessig, D. F., 1996. Salicylic acid is a modulator of tobacco and mammalian catalases. *J. Biol. Chem.*, **271**: 28492-28501.
- El Tayeb, M. A., 2005. Response of barley grains to the interactive effect of salinity and salicylic acid. *Plant Growth Regul.*, **45**: 215-224.
- Enyedi, A. J., Yalpani, N., Silverman, P., and Raskin, I., 1992. Localization, conjugation, and function of salicylic acid in tobacco during the hypersensitive reaction to tobacco mosaic virus. *Proc. Natl. Acad. Sci. USA*, **89**: 2480-2484.
- Enyedi, A. J., 1999. Induction of salicylic acid biosynthesis and systemic acquired resistance using the active oxygen species generator rose bengal. *J. Plant Physiol.*, **154**: 106-112.
- Ervin, E. H., Zhang, X. Z., and Fike, J. H., 2004. Ultraviolet-B radiation damage on Kentucky Bluegrass II: Hormone supplement effects. *Hort Sci.*, **39**: 1471-1474.
- Ervin, E. H., Zhang, X. Z., and Schmidt, R. E., 2005. Exogenous salicylic acid enhances post-transplant success of heated Kentucky bluegrass and tall fescue sod. *Crop Sci.*, **45**: 240-244.
- Evans, N. H., McAinsh, M. R., Hetherington, A. M., and Knight, M. R., 2005. ROS perception in *Arabidopsis thaliana*: the ozone-induced calcium response. *Plant J.*, **41**: 615-626.
- Farmer, E. E., and Ryan, C.A., 1992. Octadecanoid precursors of jasmonic acid activate the synthesis of wound-inducible proteinase inhibitors. *Plant Cell*, **4**: 129-134.
- Federico, M. L., Kaeppeler, H. F., and Skadsen, R. W., 2005. The complex developmental expression of a novel stress-responsive barley Ltp gene is determined by a shortened promoter sequence. *Plant Mol. Biol.*, **57**: 35-51.
- Feys, B. J., and Parker, J. E., 2000. Interplay of signaling pathways in plant disease resistance. *Trends Genet.*, **16**: 449-455.
- Foley, S., Navaratnam, S., McGarvey, D. J., Land, E. J., Truscott, G., and Rice-Evans, C. A., 1999. Singlet oxygen quenching and the redox properties of hydroxycinnamic acids. *Free Radical Bio. Med.*, **26**: 1202-1208.
- Freeman, J. L., Persans, M. W., Nieman, K., Albrecht, C., Peer, W., Pickering, I. J., and Salt, D. E., 2004. Increased glutathione biosynthesis plays a role in nickel tolerance in *Thlaspi* nickel hyperaccumulators. *Plant Cell*, **16**: 2176-2191.
- Freeman, J. L., Garcia, D., Kim, D., Hopf, A., and Salt, D. E., 2005. Constitutively elevated salicylic acid signals glutathione-mediated nickel tolerance in *Thlaspi* nickel hyperaccumulators. *Plant Physiol.*, **137**: 1082-1091.
- Fung, R. W. M., Wang, C. Y., Smith, D. L., Gross, K. C. and Tian, M. S., 2004. MeSA and MeJA increase steady-state transcript levels of alternative oxidase and resistance against chilling injury in sweet peppers (*Capsicum annuum* L.). *Plant Sci.*, **166**: 711-719.
- Gaffney, T., Friedrich, L., Vernooij, B., Negrotto, D., Nye, G., Uknes, S., Ward, E., Kessmann, H., and Ryals, J., 1993. Requirement of salicylic acid for the induction of systemic acquired resistance. *Science*, **261**: 754-756.
- Ganesan, V., and Thomas, G., 2001. Salicylic acid response in rice: influence of salicylic acid on H₂O₂ accumulation and oxidative stress. *Plant Sci.*, **160**: 1095-1106.
- Garretón, V., Carpinelli, J., Jordana, X., and Holuigue, L., 2002. The as-1 promoter element is an oxidative stress-responsive element and salicylic acid activates it via oxidative species. *Plant Physiol.*, **130**: 1516-1526.

- Gechev, T., Gadjev, I., Van Breusegem, F., Inze, D., Dukiandjiev, S., Toneva, V., and Minkov, I., 2002. Hydrogen peroxide protects tobacco from oxidative stress by inducing a set of antioxidant enzymes. *Cell. Mol. Life Sci.*, **59**: 708-714.
- Ghasempour, H. R., Anderson, E. M., and Gaff, D.F., 2001. Effects of growth substances on the protoplasmic drought tolerance of leaf cells of the resurrection grass, *Sporobolus stapfianus*. *Aust. J. Plant Physiol.*, **28**: 1115-1120.
- Glass, A. D. M., 1973. Influence of phenolic acids on ion uptake. I. Inhibition of phosphate uptake. *Plant Physiol.*, **51**: 1037-1041.
- Glass, A. D. M., 1974a. Influence of phenolic acids on ion uptake. III. Inhibition of potassium absorption. *J. Exp. Bot.*, **25**: 1104-1113.
- Glass, A. D. M., 1974b. Influence of phenolic acids on ion uptake. IV. Depolarization of membrane potentials. *Plant Physiol.*, **54**: 855-858.
- Godoy, A. V., Lazzaro, A. S., Casalongue, C. A., and San Segundo, B., 2000. Expression of a *Solanum tuberosum* cyclophilin gene is regulated by fungal infection and abiotic stress conditions. *Plant Sci.*, **152**: 123-134.
- Grant, J. J., Chini, A., Basu, D., and Loake, G. J., 2003. Targeted activation tagging of the *Arabidopsis* NBS LRR gene, ADR1, conveys resistance against virulent pathogens. *Mol. Plant Microbe Interact.*, **16**: 669-681.
- Guan, L., and Scandalios, J. G., 1995. Developmentally related responses of maize catalase genes to salicylic acid. *Proc. Natl. Acad. Sci. USA*, **92**: 5930-5934.
- Guerinot, M. L., and Salt, D. E., 2001. Fortified foods and phytoremediation: two sides of the same coin. *Plant Physiol.*, **125**: 164-167.
- Gupta, V., Willits, M. G., and Glazebrook, J., 2000. *Arabidopsis thaliana* EDS4 contributes to salicylic acid (SA)-dependent expression of defense responses: evidence for inhibition of jasmonic acid signaling by SA. *Mol. Plant Microbe Interact.*, **13**: 503-511.
- Hamada, A. M., 1998. Effects of exogenously added ascorbic acid, thiamin or aspirin on photosynthesis and some related activities of drought-stressed wheat plants. In: *Photosynthesis: Mechanisms and effects*, G., Garab ed., Kluwer Acad. Publ., Dordrecht, Vol. 4 pp. 2581-2584.
- Hamada, A. M., and Al-Hakimi, A. M. A., 2001. Salicylic acid versus salinity-drought-induced stress on wheat seedlings. *Rostl. Vyr.*, **47**: 444-450.
- Harmon, A. C., Gribskov, M., Gubrium, E., and Harper, J. F., 2001. The CDPK superfamily of protein kinase. *New Phytol.*, **151**: 175-183.
- He, C. Y., Zhang, J.S., and Chen, S.Y., 2002. A soybean gene encoding a proline-rich protein is regulated by salicylic acid, an endogenous circadian rhythm and by various stresses. *Theor. Appl. Gen.*, **104**: 1125-1131.
- He, Y. L., Liu, Y. L., Cao, W. X., Huai, M. F., Xu, B. G., and Huang, B. G., 2005. Effects of salicylic acid on heat tolerance associated with antioxidant metabolism in Kentucky bluegrass. *Crop Sci.*, **45**: 988-995.
- Hettiarachchi, G. H. C. M., Reddy, M. K., Sopory, S. K., and Chattopadhyay, S., 2005. Regulation of TOP2 by various abiotic stresses including cold and salinity in pea and transgenic tobacco plants. *Plant Cell Physiol.*, **46**: 1154-1160.
- Holk, A., Rietz, S., Zahn, M., Quader, H., and Scherer, G. F. E., 2002. Molecular Identification of Cytosolic, Patatin-Related Phospholipases A from *Arabidopsis* with Potential Functions in Plant Signal Transduction. *Plant Physiol.*, **130**: 90-101.
- Hollósy, F., 2002. Effects of ultraviolet radiation on plant cells. *Micron*, **33**: 179-197.
- Horváth, E., Janda, T., Szalai G., and Páldi, E., 2002. In vitro salicylic acid inhibition of catalase activity in maize: differences between the isozymes and a possible role in the induction of chilling tolerance. *Plant Sci.*, **163**: 1129-1135.

- Hoyos, M. E., and Zhang, S.Q., 2000. Calcium-independent activation of salicylic acid-induced protein kinase and a 40-kilodalton protein kinase by hyperosmotic stress. *Plant Physiol.*, **122**: 1355-1363.
- Hung, W. C., Huang, D. D., Yeh, C. M., and Huang, H. J., 2005. Reactive oxygen species, calcium and serine/threonine phosphatase are required for copper-induced MAP kinase gene OsMAPK2, expression in rice. *Plant Growth Regul.*, **45**: 233-241.
- Inada, M., Ueda, A., Shi, W. M., and Takabe, T., 2005. A stress-inducible plasma membrane protein 3 (AcPMP3) in a monocotyledonous halophyte, *Aneurolepidium chinense*, regulates cellular Na⁺ and K⁺ accumulation under salt stress. *Planta*, **220**: 395-402.
- Ito, Y., Saisho, D., Nakazono, M., Tsutsumi, N., and Hirai, A., 1997. Transcript levels of tandem-arranged alternative oxidase genes in rice are increased by low temperature. *Gene*, **203**: 121-129.
- Iuchi, S., Yamaguchi-Shinozaki, K., Urao, T., and Shinozaki, K., 1996. Characterization of two cDNAs for novel drought-inducible genes in the highly drought-tolerant cowpea. *J. Plant Res.*, **109**: 415-424.
- Jagendorf, A. T., and Takabe, T., 2001. Inducers of glycinebetaine synthesis in barley. *Plant Physiol.*, **127**: 1827-1835.
- Jain, A., and Srivastava, H. S. 1981. Effect of salicylic acid on nitrate reductase activity in maize seedlings. *Physiol. Plant.*, **51**: 339-342.
- Janda, T., Szalai, G., Tari, I., and Páldi, E., 1997. Exogenous salicylic acid has an effect on chilling symptoms in maize (*Zea mays* L.) plants. In: *Crop development for cool and wet European climate*, P., Sowinski, B., Zagdanska, A., Aniol, P., Klaus eds., ECSP-EEC-EAEC, Brussels, Belgium 179-187.
- Janda, T., Szalai, G., Antunovics, Zs. Ducruet, J.-M., and Páldi, E. 1998. Effects of salicylic acid and related compounds on photosynthetic parameters in young maize (*Zea mays* L.) plants. In: *Photosynthesis: Mechanisms and effects*, G., Garab ed., Kluwer Acad. Publ., Dordrecht, Kluwer Acad. Publ. pp. 3869-3872.
- Janda, T., Szalai, G., Tari, I., and Páldi, E., 1999. Hydroponic treatment with salicylic acid decreases the effect of chilling injury in maize (*Zea mays* L.) plants. *Planta*, **208**: 175-180.
- Janda, T., Szalai, G., Antunovics, Zs., Horváth, E., and Páldi, E., 2000. Effect of benzoic acid and aspirin on chilling tolerance and photosynthesis in young maize plants. *Maydica*, **45**: 29-33.
- Janda, T., Szalai, G., Rios-Gonzalez, K., Veisz, O., and Páldi, E., 2003. Comparative study of frost tolerance and antioxidant activity in cereals. *Plant Sci.*, **164**: 301-306.
- Jang, C. S., Lee, H. J., Chang, S. J., and Seo, Y. W., 2004. Expression and promoter analysis of the TaLTP1 gene induced by drought and salt stress in wheat (*Triticum aestivum* L.). *Plant Sci.*, **167**: 995-1001.
- Janowiak, F., and Dörffling, K., 1996. Chilling tolerance of 10 maize genotypes as related to chilling-induced changes in ACC and MACC contents. *J. Agron. Crop Sci.*, **177**: 175-184.
- Jonak, C., Ókrész, L., Bögre, L., and Hirt, H. 2002. Complexity, cross talk and integration of plant MAP kinase signalling. *Curr. Opin. Plant Biol.*, **5**: 415-424.
- Kader, J. C., 1996. Lipid transfer proteins in plants. *Annu. Rev. Plant Physiol. Plant Mol. Biol.*, **47**: 627-654.
- Kang, H. M., and Saltveit, M. E., 2002. Chilling tolerance of maize, cucumber and rice seedling leaves and roots are differentially affected by salicylic acid. *Physiol. Plant.*, **115**: 571-576.
- Kang, G. Z., Wang, C. H., Sun, G. C., and Wang, Z. X., 2003a. Salicylic acid changes activities of H₂O₂-metabolizing enzymes and increases the chilling tolerance of banana seedlings. *Environ. Exp. Bot.*, **50**: 9-15.

- Kang, G. Z., Wang, Z. X., and Sun, G. C., 2003b. Participation of H₂O₂ in enhancement of cold chilling by salicylic acid in banana seedlings. *Acta Bot. Sin.*, **45**: 567-573.
- Kanofsky, J. R., and Sima, P., 1991. Singlet oxygen production from the reactions of ozone with biological molecules. *J. Biol. Chem.*, **266**: 9039-9042.
- Khan, W., Prithiviraj, B., and Smith, D. L., 2003. Photosynthetic responses of corn and soybean to foliar application of salicylates. *J. Plant Physiol.*, **160**: 485-492.
- Kiba, A., Nishihara, M., Tsukatani, N., Nakatsuka, T., Kato, Y., and Yamamura, S., 2004. A peroxiredoxin Q homolog from gentians is involved in both resistance against fungal disease and oxidative stress. *Plant Cell Physiol.*, **46**: 1007-1015.
- Kim, H., Mun, J. H., Byun, B. H., Hwang, H. J., Kwon, Y. M., and Kim, S. G., 2002. Molecular cloning and characterization of the gene encoding osmotin protein in *Petunia hybrida*. *Plant Sci.*, **162**: 745-752.
- Kim, A. S., Kim, Y. O., Ryu, H. J., Kwak, Y. S., Lee, J. Y., and Kang, H. S., 2003a. Isolation of stress-related genes of rubber particles and latex in fig tree (*Ficus carica*) and their expressions by abiotic stress or plant hormone treatments. *Plant Cell Physiol.*, **44**: 412-419.
- Kim JA, Agrawal GK, Rakwal R, Han KS, Kim KN, Yun CH, Heu S, Park SY, Lee YH, and Jwa NS., 2003b. Molecular cloning and mRNA expression analysis of a novel rice (*Oryza sativa* L.) MAPK kinase kinase, OsEDR1, an ortholog of *Arabidopsis* AtEDR1, reveal its role in defense/stress signalling pathways and development. *Biochem. Biophys. Res. Comm.*, **300**: 868-876.
- Kim, M., Yang, K. S., Kim, Y. K., Paek, K. H., and Pai, H. S., 2003c. Molecular characterization of NbPAF encoding the alpha 6 subunit of the 20S proteasome in *Nicotiana benthamiana*. *Mol. Cells*, **15**: 127-132.
- Kim, S. T., Kim, S. G., Hwang, D. H., Kang, S. Y., Koo, S. C., Cho, M. J., and Kang, K. Y., 2004. Expression of a salt-induced protein (SALT) in suspension-cultured cells and leaves of rice following exposure to fungal elicitor and phytohormones. *Plant Cell Rep.*, **23**: 256-262.
- Klessig, D. F., Durner, J., Noad, R., Navarre, D. A., Wendehenne, D., Kumar, D., Zhou, J. M., Shah, J., Zhang, S., Kachroo, P., Trifa, Y., Pontier, D., Lam, E., and Silva, H., 2000. Nitric oxid and salicylic acid signalling in plant defense. *Proc. Natl. Acad. Sci. USA*, **97**: 8849-8855.
- Kling, G. J., and Meyer, M. M., 1983. Effect of phenolyc compounds and indolacetic acid on adventitious root initiation in cuttings of *Phaseolus aureus*, *Acer saccharinum*, and *Acer griseum*. *Hort. Sci.*, **18**: 352-354.
- Knörzer, O. C., Lederer, B., Durner, J., and Böger, P., 1999. Antioxidative defense activation in soybean cells. *Physiol. Plant.*, **107**: 294-302.
- Kocsy, G., Owtrim, G., Brander, K., and Brunold, C., 1997. Effect of chilling on the diurnal rhythm of enzymes involved in protection against oxidative stress in a chilling tolerant and a chilling sensitive maize genotype. *Physiol. Plant.*, **99**: 249-254.
- Kocsy, G., Galiba, G., and Brunold, C., 2001. Role of glutathione in adaptation and signalling during chilling and cold acclimation in plants. *Physiol. Plant.*, **113**: 158-164.
- Kocsy, G., Kobrehel, K., Szalai, G., Duviau, M.P., Búzás, Z., and Galiba, G., 2004. Abiotic stress-induced changes in glutathione and thioredoxin h levels in maize. *Environ. Exp. Bot.*, **52**: 101-112.
- Korkmaz, A., Tiryaki, I., Nas, M. N., and Ozbay, N., 2004. Inclusion of plant growth regulators into priming solution improves low-temperature germination and emergence of watermelon seeds. *Can. J. Plant Sci.*, **84**: 1161-1165.

- Korkmaz, A., 2005. Inclusion of acetyl salicylic acid and methyl jasmonate into the priming solution improves low temperature germination and emergence of sweet pepper. *Hort Sci.*, **40**: 197-200.
- Krämer, U., Pickering, I. J., Prince, R. C., Raskin, I., and Salt, D. E., 2000. Subcellular localization and speciation of nickel in hyperaccumulator and nonaccumulator *Thlaspi* species. *Plant Physiol.*, **122**: 1343-1353.
- Lam, E., Benfey, P. N., Gilmartin, P. M., Fang, R.-X., and Chua, N.-H., 1989. Site-specific mutations alter in vitro factor binding and change promoter expression pattern in transgenic plants. *Proc. Natl. Acad. Sci. USA*, **86**: 7890-7894.
- Lamarck, J. B., 1778. In: Flore Francaise 3. L'Emprimerie Royale, Paris, pp. 537-539.
- Lance, C., 1972. La respiration de l'*Arum maculatum* au cours du développement de l'inflorescence. *Ann. Sci. Nat. Bot. Biol. Veg. Ser. 12*, **13**: 477-495.
- Landberg, T., and Greger, M., 2002. Differences in oxidative stress in heavy metal resistant and sensitive clones of *Salix viminalis*. *J. Plant Physiol.*, **159**: 69-75.
- Larkindale, J., and Knight, M. R., 2002. Protection against heat stress-induced oxidative damage in arabidopsis involves calcium, abscisic acid, ethylene, and salicylic acid. *Plant Physiol.*, **128**: 682-695.
- Larkindale, J., and Huang, B., 2004. Thermotolerance and antioxidant systems in *Agrostis stolonifera*: Involvement of salicylic acid, abscisic acid, calcium, hydrogen peroxide, and ethylene. *J. Plant Physiol.*, **161**: 405-413.
- Larkindale, J., Hall, J. D., Knight, M. R., and Vierling, E., 2005. Heat stress phenotypes of arabidopsis mutants implicate multiple signaling pathways in the acquisition of thermotolerance. *Plant Physiol.*, **138**: 882-897.
- Larque-Saavedra, A., 1978. The antitranspirant effect of acetylsalicylic acid on *Phaseolus vulgaris* L. *Physiol. Plant.*, **43**: 126-128.
- Larque-Saavedra, A., 1979. Stomatal closure in response to acetylsalicylic acid treatments. *Z. Pflanzenphysiol.*, **93**: 371-375.
- Leclercq, J., Ranty, B., Sanchez-Ballesta, M. T., Li, Z. G., Jones, B., Jauneau, A., Pech, J. C., Latche, A., Ranjeva, R., and Bouzayen, M., 2005. Molecular and biochemical characterization of LeCRK1, a ripening-associated tomato CDPK-related kinase. *J. Exp. Bot.*, **56**: 25-35.
- Lee, S. S., Kawakita, K., Tsuge, T., and Doke, N., 1992. Stimulation of phospholipase A₂ in strawberry cells treated with AF-toxin 1 produced by *Alternaria alternata* strawberry phenotype. *Physiol. Mol. Plant Pathol.*, **41**: 283-294.
- Lee, H., León, J., and Raskin, I., 1995. Biosynthesis and metabolism of salicylic acid. *Proc. Natl. Acad. Sci. USA*, **92**: 4076-4079.
- Lee, S. C., and Hwang, B. K., 2003. Identification of the pepper SAR8.2 gene as a molecular marker for pathogen infection, abiotic elicitors and environmental stresses in *Capsicum annuum*. *Planta*, **216**: 387-396.
- León, J., Lawton, M. A., and Raskin, I., 1995. Hydrogen peroxide stimulates salicylic acid biosynthesis in tobacco. *Plant Physiol.*, **108**: 1673-1678.
- Li, Z. G., Zhao, L. X., Kai, G. Y., Yu, S. W., Cao, Y. F., Pang, Y. Z., Sun, X. F., and Tang, K. X., 2004. Cloning and expression analysis of a water stress-induced gene from *Brassica oleracea*. *Plant Physiol. Biochem.*, **42**: 789-794.
- Liu, G. S., Sheng, X. Y., Greenshields, D. L., Ogieglo, A., Kaminskyj, S., Selvaraj, G., and Wei, Y. D., 2005. Profiling of wheat class III peroxidase genes derived from powdery mildew-attacked epidermis reveals distinct sequence-associated expression patterns. *Mol. Plant Microbe Interact.*, **18**: 730-741.

- Lopez-Delgado, H., Dat, J. F., Foyer, C. H., and Scott, I. M., 1998. Induction of thermotolerance in potato microplants by acetylsalicylic acid and H₂O₂. *J. Exp. Bot.*, **49**: 713-720.
- Luo, J. P., Jiang, S. T., and Pan, L. J., 2001. Enhanced somatic embryogenesis by salicylic acid of *Astragalus adsurgens* Pall.: relationship with H₂O₂ production and H₂O₂-metabolizing enzyme activities. *Plant Sci.*, **161**: 125-132.
- Luxova, M., Gasparikova, O., 1999. The effect of low temperature on root respiration in maize. *Biologia*, **54**: 453-458.
- Malamy, J., Carr, J. P., Klessig, D. F., and Raskin, I., 1990. Salicylic acid: A likely endogenous signal in the resistance response of tobacco to viral infection. *Science*, **250**: 1002-1004.
- Margispinheiro, M., Marivet, J., and Burkard, G., 1994. Bean class-IV chitinase gene - structure, developmental expression and induction by heat-stress. *Plant Sci.*, **98**: 163-173.
- Marivet, J., Margispinheiro, M., Frendo, P., and Burkard, G., 1994. Bean cyclophilin gene-expression during plant development and stress conditions. *Plant Mol. Biol.*, **26**: 1181-1189.
- Marivet, J., Frendo, P., and Burkard, G., 1995. DNA-sequence analysis of a cyclophilin gene from maize - developmental expression and regulation by salicylic-acid. *Mol. Gen. Genet.*, **247**: 222-228.
- Martin, M. L., and Busconi, L., 2001. A rice membrane-bound calcium-dependent protein kinase is activated in response to low temperature. *Plant Physiol.*, **125**: 1442-1449.
- Mauzerall, D. L., and Wang, X., 2001. Protecting agricultural crops from the effects of tropospheric ozone exposure: reconciling science and standard setting in the United states, Europe and Asia. *Annu. Rev. Energy Environ.*, **26**: 237-268.
- Maxwell, D. P., Nickels, R., and McIntosh, L., 2002. Evidence of mitochondrial involvement in the transduction of signals required for the induction of genes associated with pathogen attack and senescence. *Plant J.*, **29**: 269-279.
- McClintock, B., 1984, The significance of responses of the genome to challenge. *Science*, **226**: 792-801.
- Meeuse, B. J. D., Raskin, I., 1988. Sexual reproduction in the *Arum* lily family with emphasis on thermogenicity. *Sex. Plant Reprod.*, **1**: 3-15.
- Mehlhorn, H., Tabner, B. J., and Wellburn, A. R., 1990. Electron spin resonance evidence for the formation of free radicals in plants exposed to ozone. *Physiol. Plant.*, **79**: 377-383.
- Métraux, J.-P., Signer, H., Ryals, J., Ward, E., Wyss-Benz, M., Gaudin, J., Raschdorf, K., Schmid, E., Blum, W., and Inverardi, B., 1990. Increase in salicylic acid at the onset of systemic acquired resistance in cucumber. *Science*, **250**: 1004-1006.
- Metwally, A., Finkemeier, I., Georgi, M., and Dietz, K.-J. 2003. Salicylic acid alleviates the cadmium toxicity in barley seedlings. *Plant. Physiol.*, **132**: 272-281.
- Milla, M. A. R., Maurer, A., Huete, A. R., and Gustafson, J. P., 2003. Glutathione peroxidase genes in *Arabidopsis* are ubiquitous and regulated by abiotic stresses through diverse signalling pathways. *Plant J.*, **36**: 602-615.
- Minibaeva, F. V., and Gordon, L. K., 2003. Superoxide production and the activity of extracellular peroxidase in plant tissues under stress conditions. *Rus. J. Plant Physiol.*, **50**: 411-416.
- Mishra, A., and Choudhuri, M. A., 1997. Ameliorating effects of salicylic acid on lead and mercury - induced inhibition of germination and early seedling growth of two rice cultivars. *Seed Sci. Technol.*, **25**: 263-270.
- Mittler, R., 2002. Oxidative stress, antioxidants and stress tolerance. *Trends Plant Sci.*, **7**: 405-410.

- Moons, A., 2003. Osgtu3 and osgtu4, encoding tau class glutathione S-transferases, are heavy metal- and hypoxic stress-induced and differentially salt stress-responsive in rice roots. *FEBS Lett.*, **553**: 427-432.
- Morris, P. C., 2001. MAP kinase signal transduction pathways in plants. *New Phytol.*, **151**: 67-89.
- Moynihan, M. R., Ordentlich, A., and Raskin, I., 1995. Chilling-induced heat evolution in plants. *Plant Physiol.*, **108**: 995-999.
- Munne-Bosch, S., and Penuelas, J., 2003. Photo- and antioxidative protection, and a role for salicylic acid during drought and recovery in field-grown *Phillyrea angustifolia* plants. *Planta*, **217**: 758-766.
- Narusaka, Y., Narusaka, M., Seki, M., Fujita, M., Ishida, J., Nakashima, M., Enju, A., Sakurai, T., Satou, M., Kamiya, A., Park, P., Kobayashi, M., and Shinozaki, K., 2003. Expression profiles of *Arabidopsis* phospholipase A IIA gene in response to biotic and abiotic stresses. *Plant Cell Physiol.*, **44**: 1246-1252.
- Narusaka, Y., Narusaka, M., Seki, M., Umezawa, T., Ishida, J., Nakajima, M., Enju, A., and Shinozaki, K., 2004. Crosstalk in the responses to abiotic and biotic stresses in *Arabidopsis*: Analysis of gene expression in cytochrome P450 gene superfamily by cDNA microarray. *Plant Mol. Biol.*, **55**: 327-342.
- Németh, M., Janda, T., Horváth, E., Páldi, E., and Szalai, G., 2002. Exogenous salicylic acid increases polyamine content but may decrease drought tolerance in maize. *Plant Sci.*, **162**: 569-574.
- Niki, T., Mitsuhara, I., Seo, S., Ohtsubo, N., and Ohashi, Y., 1998. Antagonistic effect of salicylic acid and jasmonic acid on the expression of pathogenesis-related (PR) protein genes in wounded mature tobacco leaves. *Plant Cell Physiol.*, **39**: 500-507.
- Norman, C., Howell, K. A., Millar, A. H., Whelan, J. M., and Day, D. A., 2004. Salicylic acid is an uncoupler and inhibitor of mitochondrial electron transport. *Plant Physiol.*, **134**: 492-501.
- Ogawa, D., Nakajima, N., Sano, T., Tamaoki, M., Aono, M., Kubo, A., Kanna, M., Ioki, M., Kamada, H., and Saji, H., 2005. Salicylic acid accumulation under O₃ exposure is regulated by ethylene in tobacco plants. *Plant Cell Physiol.*, **46**: 1062-1072.
- Pál, M., Szalai, G., Horváth, E., Janda, T., and Páldi, E., 2002. Effect of salicylic acid during heavy metal stress. *Acta Biol. Szegediensis*, **46**: 119-120.
- Pál, M., Horváth, E., Janda, T., Páldi, E., and Szalai, G., 2005. Cadmium stimulate accumulation of salicylic acid and its putative precursors in maize (*Zea mays* L.) plants. *Physiol. Plant.*, **125**: 356-364.
- Pancheva, T. V., and Popova, L. P., 1998. Effect of salicylic acid on the synthesis of ribulose-1,5-bisphosphate carboxylase/oxygenase in barley leaves. *J. Plant Physiol.*, **152**: 381-386.
- Pastori, G. M., and Foyer, C. H., 2002. Common components, networks and pathways of cross-tolerance to stress. The central role of 'redox' and abscisic acid-mediated controls. *Plant Physiol.*, **129**: 460-468.
- Pell, E. J., Schlagnhauser, C. D., and Arteca, R. N., 1997. Ozone-induced oxidative stress: mechanisms of action and reaction. *Physiol. Plant.*, **100**: 264-273.
- Qi, Y. H., Kawano, N., Yamauchi, Y., Ling, J. Q., Li, D. B., and Tanaka, K., 2005. Identification and cloning of a submergence-induced gene OsGGT (glycogenin glucosyltransferase) from rice (*Oryza sativa* L.) by suppression subtractive hybridization. *Planta*, **221**: 437-445.
- Quiroz-Figueroa, F., Mendez-Zeel, M., Larque-Saavedra, A., and Loyola-Vargas, V. M., 2001. Picomolar concentrations of salicylates induce cellular growth and enhance somatic embryogenesis in *Coffea arabica* tissue culture. *Plant Cell Rep.*, **20**: 679-684.

- Rai, V. K., Sharma, S. S., and Sharma, S., 1986. Reversal of ABA-induced stomatal closure by phenolic compounds. *J. Exp. Bot.*, **37**: 129-134.
- Rajasekaran, L. R., Stiles, A., and Caldwell, C. D., 2002. Stand establishment in processing carrots- Effects of various temperature regimes on germination and the role of salicylates in promoting germination at low temperatures. *Can. J. Plant Sci.*, **82**: 443-450.
- Rakwal, R., Agrawal, G. K., and Agrawal, V. P., 2001. Jasmonate, salicylate, protein phosphatase 2A inhibitors and kinetin up-regulate OsPR5 expression in cut-responsive rice (*Oryza sativa*). *J. Plant Physiol.*, **158**: 1357-1362.
- Rao, M. V., Paliyath, G., Ormrod, D. P., Murr, D. P., and Watkins, C. B., 1997. Influence of salicylic acid on H₂O₂ production, oxidative stress, and H₂O₂-metabolizing enzymes. *Plant Physiol.*, **115**: 137-149.
- Rao, M. V., and Davis, K. R., 1999. Ozone-induced cell death occurs via two distinct mechanisms in *Arabidopsis*: the role of salicylic acid. *Plant J.*, **17**: 603-614.
- Rao, M. V., Lee, H. I., Creelman, R. A., Mullet, J. E., and Davis, K. R., 2000. Jasmonic acid signaling modulates ozone-induced hypersensitive cell death. *Plant Cell*, **12**: 1633-1646.
- Rao, M. V. and Davis, K. R., 2001. The physiology of ozone-induced cell death. *Planta*, **213**: 682-690.
- Rao, M. V., Lee, H., and Davis, K. R., 2002. Ozone-induced ethylene production is dependent on salicylic acid, and both salicylic acid and ethylene act in concert to regulate ozone-induced cell death. *Plant J.*, **32**: 447-456.
- Raskin, I., Ehmann, A., Melander, W. R., and Meeuse, B. J. D., 1987. Salicylic acid: a natural inducer of heat production in *Arum* lilies. *Science*, **237**: 1601-1602.
- Raskin, I., Skubatz, H., Tang, W., and Meeuse, B. J. D., 1990. Salicylic acid levels in thermogenic and non-thermogenic plants. *Ann. Bot.*, **66**: 369-373.
- Raskin, I., 1992. Role of salicylic acid in plants. *Annu. Rev. Plant Physiol. Plant Mol. Biol.*, **43**: 439-463.
- Raskin, I., 1995. Salicylic acid. In: *Plant hormones. Physiology, Biochemistry and Molecular Biology 2nd Edition*, P. J., Davies ed., Kluwer Acad. Publ. Dordrecht, The Netherlands. pp188-205.
- Rhoads, D. M., and McIntosh, L., 1992. Cytochrome and alternative pathway respiration in tobacco. Effects of salicylic acid. *Plant Physiol.*, **103**: 877-883.
- Ribas-Carbo, M., Aroca, R., Gonzalez-Meler, M. A., Irigoyen, J. J., and Sanchez-Diaz, M., 2000. The electron partitioning between the cytochrome and alternative respiratory pathways during chilling recovery in two cultivars of maize differing in chilling sensitivity. *Plant Physiol.*, **122**: 199-204.
- Rietz, S., Holk, A., and Scherer, G. F. E., 2004. Expression of the patatin-related phospholipase A gene AtPLA IIA in *Arabidopsis thaliana* is up-regulated by salicylic acid, wounding, ethylene, and iron and phosphate deficiency. *Planta*, **219**: 743-753.
- Rüffer, M., Steipe, B., and Zenk, M. H., 1995. Evidence against specific binding of salicylic acid to plant catalase. *FEBS Lett.*, **377**: 175-180.
- Sahu, G. K., Kar, M., and Sabat, S. C., 2002. Electron transport activities of isolated thylakoids from wheat plants grown in salicylic acid. *Plant Biol.*, **4**: 321-328.
- Saijo, Y., Hata, S., Kyojuka, J., Shimamoto, K., and Izui, K., 2000. Over-expression of a single Ca²⁺-dependent protein kinase confers both cold and salt/drought tolerance on rice plants. *Plant J.*, **23**: 319-327.
- Saitanis, C. J., and Karandinos, M. G., 2002. Effects of ozone on tobacco (*Nicotiana tabacum* L.) varieties. *J. Agron. Crop Sci.*, **188**: 51-58.
- Salzman, R. A., Brady, J. A., Finlayson, S. A., Buchanan, C. D., Summer, E. J., Sun, F., Klein, P. E., Klein, R. R., Pratt, L. H., Cordonnier-Pratt, M. M., and Mullet, J. E., 2005. Transcriptional profiling of sorghum induced by methyl jasmonate, salicylic acid, and

- aminocyclopropane carboxylic acid reveals cooperative regulation and novel gene responses. *Plant Physiol.*, **138**: 352-368.
- Samuel, M. A., Walia, A., Mansfield, S. D., and Ellis, B. E., 2005. Overexpression of SIPK in tobacco enhances ozone-induced ethylene formation and blocks ozone-induced SA accumulation. *J. Exp. Bot.*, **56**: 2195-2201.
- Sánchez-Casas P., and Klessig D. F., 1994. A salicylic acid-binding activity and a salicylic acid-inhibitable catalase activity are present in a variety of plant species. *Plant Physiol.*, **106**: 1675-1679.
- Sandermann, H. Jr., 1996. Ozone and plant health. *Annu. Rev. Phytopathol.*, **34**: 347-366.
- Sandermann, H. Jr., Ernst, D., Heller, W., and Langebartels, C., 1998. Ozone: an abiotic elicitor of plant defence reactions. *Trends Plant Sci.*, **3**: 47-50.
- Scherer, G. F. E., and André, B. 1989. A rapid response to a plant hormone: auxin stimulates phospholipase A₂ in vivo and in vitro. *Biochem. Biophys. Res. Comm.*, **163**: 111-117.
- Scott, I. M., Clarke, S. M., Wood, J. E., and Mur, L. A. J., 2004. Salicylate accumulation inhibits growth at chilling temperature in *Arabidopsis*. *Plant Physiol.*, **135**: 1040-1049.
- Senaratna, T., Touchell, D., Bunn, E., and Dixon, K., 2000. Acetyl salicylic acid (Aspirin) and salicylic acid induce multiple stress tolerance in bean and tomato plants. *Plant Growth Regul.*, **30**: 157-161.
- Senaratna, T., Merritt, D., Dixon, K., Bunn, E., Touchell, D., and Sivasithamparam, K., 2003. Benzoic acid may act as the functional group in salicylic acid and derivatives in the induction of multiple stress tolerance in plants. *Plant Growth Regul.*, **39**: 77-81.
- Seo, S., Ishizuka, K., and Ohashi, Y., 1995a. Induction of salicylic-acid beta-glucosidase in tobacco-leaves by exogenous salicylic-acid. *Plant Cell Physiol.*, **36**: 447-453.
- Seo, S., Okamoto, M., Seto, H., Ishizuka, K., Sano, H., and Ohashi, Y., 1995b. Tobacco MAP kinase: a possible mediator in wound signal transduction pathways. *Science*, **270**: 1988-1992.
- Seppanen, M. M., Cardi, T., Hyokki, M. B., and Pehu, E., 2000. Characterization and expression of cold-induced glutathione S-transferase in freezing tolerant *Solanum commersonii*, sensitive *S.-tuberosum* and their interspecific somatic hybrids. *Plant Sci.*, **153**: 125-133.
- Singh, N. K., Bracker, C. A., Hasegawa, P. M., Handa, A. K., Buckel, S., Hermodson, M. A., Pfankoch, E., Regnier, F. E., and Bressan, R. A., 1987. Characterization of osmotin I. A thaumatin-like protein associated with osmotic adaptation in plant cells. *Plant Physiol.*, **85**: 529-536.
- Singh, B., and Usha, K., 2003. Salicylic acid induced physiological and biochemical changes in wheat seedlings under water stress. *Plant Growth Regul.*, **39**: 137-141.
- Singh, B. N., Mishra, R. N., Agarwal, P. K., Goswami, M., Nair, S., Sopory, S. K., and Reddy, M. K., 2004. A pea chloroplast translation elongation factor that is regulated by abiotic factors. *Biochem. Biophys. Res. Comm.*, **320**: 523-530.
- Sinha, S. K., Srivastava, H. S., and Tripathi, R. D., 1994. Influence of some growth-regulators and divalent-cations on the inhibition of nitrate reductase activity by lead in maize leaves. *Chemosphere*, **29**: 1775-1782.
- Sakhabutdinova, A. R., Fatkhutdinova, D. R., and Shakirova, F. M., 2004. Effect of salicylic acid on the activity of antioxidant enzymes in wheat under conditions of salination. *Appl. Biochem. Microbiol.*, **40**: 501-505.
- Shakirova, F. M., Sakhabutdinova, A. R., Bezrukova, M. V., Fatkhutdinova, R. A., and Fatkhutdinova, D. R., 2003. Changes in the hormonal status of wheat seedlings induced by salicylic acid and salinity. *Plant Sci.*, **164**: 317-322.

- Sharma, Y. K., León, J., Raskin, I., and Davis, K. R., 1996. Ozone-induced responses in *Arabidopsis thaliana*: The role of salicylic acid in the accumulation of defense-related transcripts and induced resistance. *Proc. Natl. Acad. Sci. USA*, **93**: 5099-5104.
- Shen, Y., Tang, M. J., Hu, Y. L., and Lin, Z. P., 2004. Isolation and characterization of a dehydrin-like gene from drought-tolerant *Boea crassifolia*. *Plant Sci.*, **166**: 1167-1175.
- Shinozaki, K., and Yamaguchi-Shinozaki, K., 1996. Molecular responses to drought and cold stress. *Curr. Opin. Biotech.*, **7**: 161-167.
- Shunwu, Y. W., Zhang, L. D., Zuo, K. J., Li, Z. G., and Tang, K. X., 2004. Isolation and characterization of a BURP domain-containing gene BnBDC1 from *Brassica napus* involved in abiotic and biotic stress. *Physiol. Plant.*, **122**: 210-218.
- Sticher, L., Mauch-Mani, B., and Métraux, J. P., 1997. Systemic acquired resistance. *Annu. Rev. Phytopathol.*, **35**: 235-270.
- Strobel, N. E., and Kuc, A., 1995. Chemical and biological inducers of systemic acquired resistance to pathogens protect cucumber and tobacco from damage caused by paraquat and cupric chloride. *Phytopathol.*, **85**: 1306-1310.
- Szalai, G., Tari, I., Janda, T., Pestenác, A., and Páldi, E., 2000. Effects of cold acclimation and salicylic acid on changes in ACC and MACC contents in maize during chilling. *Biol. Plant.*, **43**: 637-640.
- Szepesi, Á., Csiszár, J., Bajkán, Sz., Gémes, K., Horváth F., Erdei, L., Deér, A., Simon, L. M., and Tari, I., 2005. Role of salicylic acid pre-treatment on the acclimation of tomato plants to salt- and osmotic stress. *Acta Biol. Szegediensis*, **49**: 123-125.
- Takizawa, M., Goto, A., and Watanabe, Y., 2005. The tobacco ubiquitin-activating enzymes NtE1A and NtE1B are induced by tobacco mosaic virus, wounding and stress hormones. *Mol. Cells*, **19**: 228-231.
- Tamaoki, M., Nakajima, N., Kubo, A., Aono, M., Matsuyama, T., and Saji, H., 2003. Transcriptome analysis of O₃-exposed *Arabidopsis* reveals that multiple signal pathways act mutually antagonistically to induce gene expression. *Plant Mol. Biol.*, **53**: 443-456.
- Tang, D. Z., Christiansen, K. M., and Innes, R. W., 2005. Regulation of plant disease resistance, stress responses, cell death, and ethylene signaling in *Arabidopsis* by the EDR1 protein kinase. *Plant Physiol.*, **138**: 1018-1026.
- Tapia, G., Verdugo, I., Yanez, M., Ahumada, I., Theoduloz, C., Cordero, C., Poblete, F., Gonzalez, E., and Ruiz-Lara, S., 2005. Involvement of ethylene in stress-induced expression of the TLC1.1 retrotransposon from *Lycopersicon chilense* Dun. *Plant Physiol.*, **138**: 2075-2086.
- Tari, I., Csiszár, J., Szalai, G., Horváth, F., Pécsváradi, A., Kiss, G., Szepesi, Á., Szabó, M., and Erdei, L., 2002. Acclimation of tomato plants to salinity stress after a salicylic acid pre-treatment. *Acta Biol. Szegediensis*, **46**: 55-56.
- Tari, I., Simon, L. M., Deér, K. A., Csiszár, J., Bajkán, Sz., Kis, Gy., and Szepesi, Á., 2004. Influence of salicylic acid on salt stress acclimation of tomato plants: oxidative stress responses and osmotic adaptation. *Acta Physiol. Plant.*, **26S**: 237.
- Tasgin, E., Atici, O., and Nalbantoglu, B. 2003. Effects of salicylic acid and cold on freezing tolerance in winter wheat leaves. *Plant Growth Regul.*, **41**: 231-236.
- Urao, T., Yamaguchi-Shinozaki, K., Urao, S. and Shinozaki, K., 1993. An *Arabidopsis* myb homolog is induced by dehydration stress and its gene product binds to the conserved MYB recognition sequence. *Plant Cell*, **5**: 1529-1539.
- Vacchina, V., Mari, S., Czernic, P., Marqués, L., Pianelli, K., Schaumlöffel, D., Lebrun, M., and Lobinski, R., 2003. Speciation of nickel in a hyperaccumulating plant by high-performance liquid chromatography-inductively coupled plasma mass spectroscopy and electrospray MS/MS assisted by cloning using yeast complementation. *Anal. Chem.*, **75**: 2740-2745.

- Van Camp, W., Van Montagu, M., and Inzé, D. 1998. H₂O₂ and NO: redox signals in disease resistance. *Trends Plant Sci.*, **3**: 330-334.
- Vandeventer, H. A., 1985. Cyanide-resistant respiration and cold resistance in seedlings of maize (*Zea Mays* L.). *Ann. Bot.*, **56**: 561-563.
- Van Wees, S. C. M., and Glazebrook, J., 2003. Loss of non-host resistance of *Arabidopsis* NahG to *Pseudomonas syringae* pv. Phaseolicola is due to degradation products of salicylic acid. *Plant J.*, **33**: 733-742.
- Vernooij, B., Friedrich, L., Morse, A., Reist, R., Kolditz-Jawhar, R., Ward, E., Uknes, S., Kessmann, H., and Ryals, J. 1994. Salicylic acid is not the translocated signal responsible for inducing systemic acquired resistance but is required in signal transduction. *Plant Cell*, **6**: 959-965.
- Vierling, E., 1991. The roles of heat shock proteins in plants. *Annu. Rev. Plant Physiol. Plant Mol. Biol.*, **42**: 579-620.
- Vranová, E., Atichartpongkul, S., Villarroel, R., Van Montagu, M., Inze, D., and Van Camp, W., 2002. Comprehensive analysis of gene expression in *Nicotiana tabacum* leaves acclimated to oxidative stress. *Proc. Natl. Acad. Sci. USA*, **99**: 10870-10875.
- Wang, S. J. Lan, Y. C., Chen, S. F., Chen, Y. M., and Yeh, K. W., 2002. Wound-response regulation of the sweet potato sporamin gene promoter region. *Plant Mol. Biol.*, **48**: 223-231.
- Watahiki, M. K., Mori, H., and Yamamoto, K. T., 1995. Inhibitory effects of auxins and related substances on the activity of an *Arabidopsis* glutathione S-transferase isozyme expressed in *Escherichia coli*. *Physiol. Plant.*, **94**: 566-574.
- Wiese, J., Kranz, T., and Schubert, S., 2004. Induction of pathogen resistance in barley by abiotic stress. *Plant Biol.*, **6**: 529-536.
- Wildermuth, M. C. Dewdney, J., Wu, G., and Ausubel, F. M., 2001. Isochorismate synthase is required to synthesize salicylic acid for plant defence. *Nature*, **414**: 562-565
- Xue, G.-P., 2002. An AP2 domain transcription factor HvCBF1 activates expression of cold-responsive genes in barley through interaction with a (G/a)(C/t)CGAC motif. *Biochim. Biophys. Acta*, **1577**: 63-72.
- Xue, G.-P., 2003. The DNA-binding activity of an AP2 transcriptional activator HvCBF2 involved in regulation of low-temperature responsive genes in barley is modulated by temperature. *Plant J.*, **33**: 373-383.
- Yalpani, N., Silverman, P., Wilson, T. M. A., Kleier, D. A., and Raskin, I., 1991. Salicylic acid is a systemic signal and an inducer of pathogenesis-related proteins in virus-infected tobacco. *Plant Cell*, **3**: 809-818.
- Yalpani, N., Leon, J., Lawton, M. A., and Raskin, I., 1993. Pathway of salicylic acid biosynthesis in healthy and virus-inoculated tobacco. *Plant Physiol.*, **103**: 315-321.
- Yalpani, N., Enyedi, A. J., León, J., and Raskin, I., 1994. Ultraviolet light and ozone stimulate accumulation of salicylic acid, pathogenesis-related proteins and virus resistance in tobacco. *Planta*, **193**: 372-376.
- Yang, G., and Komatsu, S., 2000. Involvement of calcium-dependent protein kinase in rice (*Oryza sativa* L.) lamina inclination caused by brassinolide. *Plant Cell Physiol.*, **41**: 1243-1250.
- Yang, T. B., and Poovaiah, B. W., 2002. A calmodulin-binding/CGCG box DNA-binding protein family involved in multiple signaling pathways in plants. *J. Biol. Chem.*, **277**: 45049-45058.
- Yang, Z. M., Wang, J., Wang, S. H., and Xu, L. L., 2003. Salicylic acid-induced aluminium tolerance by modulation of citrate efflux from roots of *Cassia tora* L. *Planta*, **217**: 168-174.

- Yoon, G. M., Cho, H. S., Ha, H. J., Liu, J. R., and Lee, H. P., 1999. Characterization of NtCDPK1, a calcium-dependent protein kinase gene in *Nicotiana tabacum*, and the activity of its encoded protein. *Plant Mol. Biol.*, **39**: 991–1001.
- Yoon, H. S., Lee, H., Lee, I. A., Kim, K. Y., and Jo, J. K., 2004. Molecular cloning of the monodehydroascorbate reductase gene from *Brassica campestris* and analysis of its mRNA level in response to oxidative stress. *Biochim. Biophys. Acta*, **1658**: 181-186.
- Yordanova, R. Y., Christov, K. N., and Popova, L. P., 2004. Antioxidative enzymes in barley plants subjected to soil flooding. *Environ. Exp. Bot.*, **51**: 93-101.
- Yu, X.-M., Griffith, M., and Wiseman, S. B., 2001. Ethylene induces antifreeze activity in winter rye leaves. *Plant Physiol.*, **126**: 1232-1240.
- Zamski, E., Guo, W. W., Yamamoto, Y. T., Pharr, D. M., and Williamson, J. D., 2001. Analysis of celery (*Apium graveolens*) mannitol dehydrogenase (Mtd) promoter regulation in *Arabidopsis* suggests roles for MTD in key environmental and metabolic responses. *Plant Mol. Biol.*, **47**: 621-631.
- Zhang, S., and Klessig, D. F., 1997. Salicylic Acid Activates a 48-kD MAP Kinase in Tobacco *Plant Cell*, **9**: 809-824.
- Zhang, S. Q., and Klessig, D. F., 1998. The tobacco wounding-activated mitogen-activated protein kinase is encoded by SIPK. *Proc. Natl. Acad. Sci. USA.*, **95**: 7225-7230.
- Zhang, H. B., Zhang, D. B., Chen, J., Yang, Y. D., Huang, Z. J., Huang, D. F., Wang, X. C., and Huang, R. F., 2004. Tomato stress-responsive factor TSRF1 interacts with ethylene responsive element GCC box and regulates pathogen resistance to *Ralstonia solanacearum*. *Plant Mol. Biol.*, **55**: 825-834.

Chapter 6

THE ROLE OF SALICYLATES IN *RHIZOBIUM*- LEGUME SYMBIOSIS AND ABIOTIC STRESSES IN HIGHER PLANTS

FAZLI MABOOD AND DONALD SMITH

*Plant Science Department, Macdonald Campus of McGill University, 21,111 Lakeshore Road,
Sainte Anne de Bellevue, Qc, Canada, H9X 3V9.*

Abstract: Salicylic acid (SA) is an endogenous plant growth regulator. SA is involved in various physiological processes of plant growth and development and plays an active role in plant defense responses. SA also plays a major role during the early stages of *Rhizobium*-legume symbiosis. Nod factors produced by rhizobia, in response to legume produced flavonoids, affect SA content of the host plant during the early stages of nodulation. On the other hand, SA inhibits bacterial growth and the production of Nod factors by rhizobia. Exogenous application of SA delays nodule formation and decreases the number of nodules at the roots of the host plant. SA protects plants under abiotic stresses such as drought, salinity, low and high temperatures, and the damaging action of heavy metals. The ability of SA to protect plants exposed to abiotic stresses is due to the induction of a series of signal transduction cascades leading to the expression of genes responsible for the protection of plants from the stress.

Key words: Abiotic stresses, rhizobium, salicylic acid

1. INTRODUCTION

The role of salicylic acid (SA) in plant responses to pathogens (biotic stress) has been well characterized, however, the responses to abiotic stresses, and also to non-pathogenic infections, have been revealed more recently (see below). For this reason this review concentrates on the two latter aspects mentioned above.

In their natural habitats plants are constantly exposed to pathogenic and non-pathogenic microorganisms. Pathogenic microorganisms do not always cause diseases in plants. In some cases the pathogen spreads, after invading the host plant, and disease development is arrested after the initial development of necrotic lesions on the plant. The first set of plant responses to an invading pathogen are: hypersensitive response leading to localized plant cell death around the infected sites. The formation of necrotic lesions is accompanied by an array of biochemical changes in the remaining parts, so far uninfected parts of the plant, including generation of reactive oxygen species (ROS); known as oxidative burst, cell death; biosynthesis of phenolic compounds, especially SA; and induction of pathogenesis related (PR) proteins (Durrant and Dong, 2004). Once a plant has recovered from a disease, it can generate systemic resistance to future infections in the whole plants— a phenomenon known as systemic acquired resistance (SAR). The central role of SA in SAR has been studied extensively (Dempsey *et al.*, 1999; Durrant and Dong, 2004).

Another specific plant-microbe association occurs between legume plants and rhizobia. Bacteria of the family *Rhizobiaceae*, generally known as rhizobia, belong to phylogenetically distinct genera (*Azorhizobium*, *Bradyrhizobium*, *Mesorhizobium*, *Rhizobium*, and *Sinorhizobium*) and individual species of these genera have specific host ranges that allow them to nodulate either a limited or an extensive set of legumes (Perret *et al.*, 2000). The initial interaction between the two symbiotic partners is a highly specialized process and involves an exchange of signals between the host plant and the colonizing bacteria. Specific flavonoid(s) act as plant-to-bacteria signals, while specific Nod factors, structurally known as lipochitooligosaccharides (LCOs), act as bacteria-to-plant signal molecules (Schultze and Kondorosi, 1998). The plant produced signals (specific flavonoids) are recognized by the cellular membrane-bound NodD protein of rhizobia which, upon activation, binds to the ‘nod box’ sequence upstream of the *nod* genes and induce the transcription of the *nod* genes leading to the biosynthesis of Nod factors (Loh and Stacey, 2003). Nod factors are lipochitooligosaccharides (LCOs), comprised of a chitin oligomer backbone of chains of three to five 1-4 β -linked N-acetylglucosamine residues with an acyl chain at the terminal non-reducing sugar in place of an N-acetyl group (Figure 1). Upon successful exchange of signal molecules between the two symbiotic partners, bacteria attach to the root hair, cause root hair curling and induce the formation of specialized infection threads, initial steps in the organogenesis of a nitrogen fixing nodule (Broughton *et al.*, 2003).

The ability of a plant to distinguish between pathogenic and symbiotic bacteria largely depends upon the chemical communication of molecular signals between the macro and the micro partners. This initial exchange of

signals is extremely important as, at this stage, a plant discriminates between pathogenic and symbiotic partners, allowing one to enter root hairs and develop a nitrogen fixing symbiosis, or inducing an array of defense responses to isolate the invading pathogenic microorganisms. However, in both the cases, microbe is attempting to infect the plant (Broughtone *et al.*, 2003; Quirino, and Bent, 2003).

During the last decade our understanding of the roles of salicylic acid in plant microbe interactions and plant responses to abiotic stresses have improved considerably (Pieterse *et al.*, 2001; Oostendorp *et al.*, 2001; Sudha and Ravishankar, 2002). In this section we describe recent developments in our understanding of the role of SA in symbiotic plant-rhizobia interactions and their potential role in plant responses to abiotic stresses.

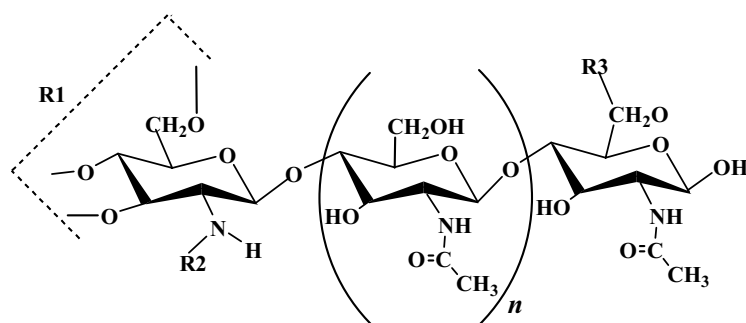

Figure 1. Nod factors produced by *Bradyrhizobium japonicum*. Nod factors are lipochitooligosaccharides (LCOs) and are composed of 3-5 N-acetylglucosamine units represented by "n". This basic structure can have different substitutions denoted at R1, R2, and R3 positions (Stacey *et al.*, 1995).

Nod metabolite	n	R1	R2	R3	(M+H) ⁺
Nod Bj-V(C _{16:0} , MeFuc)	3	H	C _{16:0}	2-O-MeFuc	1390
Nod Bj-V(C _{18:1} , MeFuc)	3	H	C _{18:1}	2-O-MeFuc	1416
Nod Bj-IV(Cb, C _{18:1} , MeFuc)	2	Cb	C _{18:1}	2-O-MeFuc	1432
Nod Bj-V(Ac, C _{16:0} , MeFuc)	3	Ac	C _{16:0}	2-O-MeFuc	1256

2. ROLE OF SALICYLIC ACID IN *RHIZOBIUM*- LEGUME SYMBIOSIS

2.1 Role of SA in the early stages of symbiosis

During pathogenic plant-microbe interactions, there is a general increase in internal SA levels that often leads to development of resistance to subsequent infections, a phenomenon known as systemic acquired resistance (SAR) (Ryals *et al.*, 1994). However, this is not the case with symbiotic plant-microbe interactions. When Martinez-Abarca *et al.* (1998) inoculated alfalfa plants with compatible rhizobia (*Rhizobium meliloti*), root SA level either decreased or remained close to that of basal levels. However, when alfalfa plants were inoculated with incompatible rhizobia (*Rhizobium leguminosarum* bv. trifolii) or a *nod* mutant of *Rhizobium meliloti* (defective in Nod factor biosynthesis), there was a marked increase in the accumulation of SA in the roots of plants. The authors, therefore, concluded that the compatible rhizobia produce certain signals (specific Nod factors) which are perceived by the host plants that suppress the accumulation of SA in host plants. Rhizobia defective in Nod factor biosynthesis or incompatible rhizobia, producing heterologous Nod factors, induce SA mediated defense response. Interestingly, in another study, Blilou *et al.* (1999) found that inoculation of pea sym30 mutant with compatible *Rhizobium leguminosarum* wild type increased SA content in the roots of pea plants. Similar accumulation in SA contents of pea roots were also found when plants (both wild type and sym30 mutant) were inoculated with Nod C⁻ mutant (defective in Nod factor biosynthesis). However, root SA content remained either at the basal level or decreased when wild type pea plants were inoculated with compatible *Rhizobium leguminosarum*.

Nod factors are highly active at sub-micromolar concentrations, even when applied to other plant parts. Recently we have shown that foliar application of purified Nod factors from *Bradyrhizobium japonicum* suppressed SA content of the host soybean plant. Three days after the application of Nod factors, to the leaves of soybean plants, the SA concentration was affected to a negligible level at both the tested concentrations (10^{-7} M and 10^{-8} M) (Mabood and Smith, unpublished data). Thus soybean leaves have a highly sensitive mechanism for the perception of Nod factors. Together these findings suggest that compatible rhizobia must suppress SA mediated defense responses of host plants in order to successfully establish symbiotic relationship.

Besides *in-planta* antagonistic role of Nod factors and SA, exogenous application of SA also has a deleterious effect on rhizobia. Exogenous application of SA (≥ 0.1 mM) inhibited growth and expression of the

nodulation genes of rhizobia. It also inhibited production of Nod factors (lipo chitoooligosaccharides - LCOs) by some rhizobia (Mabood and Smith, unpublished results). Thus exogenous application of SA disrupts the bacteria-to-plant signaling process – one of the most important initial steps of symbiosis.

2.2 Effect of SA on nodulation and nitrogen fixation of legumes

Salicylic acid strongly affects nodule formation and its subsequent development leading to decreased nodulation, nitrogen fixation and plant growth. Van Spronsen *et al.* (2003) found that application of SA (0.1mM) completely inhibited indeterminate nodule formation in vetch (*Vicia sativa* subsp. *nigra*); pea (*Pisum sativum*), including a hypernodulating mutant; alfalfa (*Medicago sativa*); and white clover (*Trifolium repens*). Application of SA also blocked the mitogenic effect of LCOs (produced by *Rhizobium leguminosarum* bv. *viciae* carrying an 18:4 acyl group) on vetch roots. However, SA application (0.1mM) did not inhibit determinate nodule formation by bean (*Phaseolus vulgaris*), lotus (*Lotus japonicus*) and soybean (*Glycine soja*). On the other hand Lian *et al.* (2000) showed that application of SA at higher concentrations (5 and 1 mM) decreased nodule number and dry mass of soybean plants, leading to decreased nitrogen fixation and lowered photosynthesis. Sato *et al.* (2002) also reported that the application of SA (as low as 100 μ M) 5 days prior to inoculation of *Bradyrhizobium japonicum* decreased nodule number and dry mass of wild type soybean as well as supernodulating soybean mutants. However, the decrease in nodule number and dry mass was less pronounced compared with wild type soybean. Salicylic acid inhibited nodule formation at the early stages of nodulation but not subsequent nodule development. Ramanujan *et al.* (1998) also observed a decrease in nodule number, nitrogen fixation and protein content of *Vigna mungo* plants when seeds were given presowing soaking treatment with SA. Exogenous application of SA prior to inoculation with *Rhizobium meliloti* also delayed nodule emergence and decreased nodule number on alfalfa roots. Salicylic acid also inhibited nodule primordia formation induced by purified Nod factors from *Rhizobium meliloti* (Martinez-Abarca *et al.* (1998).

These results suggest that exogenous application of SA affects autoregulation of nodule formation in legume plants during initial infection process with rhizobia. Due to this disruption plants produce fewer nodules in the presence of SA.

3. ROLE OF SALICYLIC ACID IN SELECTED ABIOTIC STRESSES

Salicylic acid (SA), a phytohormone, is widely distributed in plants and plays an important role in a number of physiological activities in plant. SA is well characterized for its central role in signal transduction in defense responses against pathogens (Malamy *et al.*, 1990; Durner *et al.*, 1997). SA also plays an active role in controlling transpiration, stomatal closure, seed germination, fruit yield, glycolysis, flowering and heat production (Raskin, 1992; Klessig and Malamy, 1994), and thermotolerance (Dat *et al.*, 1998a,b).

Earlier, SA received a great deal of attention related to its role in plant disease resistance. It has been shown that the accumulation of H₂O₂ is essential for the induction of plant disease resistance. Exogenous application of SA causes an increase in H₂O₂ accumulation in plant tissues, and this higher H₂O₂ concentration has been proposed to act as a signal inducing hypersensitive response and systemic acquired resistance, against pathogens (Lamb and Dixon, 1997).

Plant growth and development are strongly affected by environmental factors such as drought, salinity, heat and cold stresses (Mahajan and Tuteja, 2005). Common symptoms in response to these abiotic stresses, include wilting, inhibition of metabolic processes, chlorosis, lipid peroxidation and changes in membrane permeability and ion leakage. Together these damaging effects result in altered plant physiology, causing reduced growth and, in the case of crop plants, reduced biological yields (Saltveit and Morris, 1990; Rab and Saltveit, 1996).

In the past, major role of SA in plant was thought to be the regulation of responses to biotic stresses, however, a large body of literature now suggests that SA is also involved in responses to several abiotic stresses such as ultraviolet light, drought, salt, chilling and heat. Accumulation of SA occurs when plants are exposed to ozone or UV light (Yalpani *et al.*, 1994; Sharma *et al.*, 1996). Pretreatment of plants with SA or aspirin (acetylsalicylic acid - a derivative of SA) induced drought tolerance in bean and tomato plants (Senaratna *et al.*, 2000). Application of SA or ASA to maize plants, caused a decrease in net photosynthesis under normal growth conditions (22/20 °C); however, it induced chilling tolerance at low temperatures (2 °C) by activating antioxidant enzymes (POX and GR) (Janda *et al.*, 1999; 2000). SA has been shown to diminish the damaging effects of cold and induce cold tolerance in rice and wheat (Szalai *et al.*, 2002; Tasgin *et al.*, 2003), bean (Senaratna *et al.*, 2000; Ding *et al.*, 2002), banana (Kang *et al.*, 2003a), and tomato (Senaratna *et al.*, 2000). Kang *et al.* (2003a) reported that pretreatment of chilling-sensitive banana seedlings with SA increased H₂O₂ accumulation at higher temperatures (30/22 °C) while it reduced H₂O₂

overproduction at lower temperatures, suggesting altered H₂O₂ metabolism due to the application of SA as a component of enhanced chilling tolerance of banana seedlings. Thus SA enhanced chilling tolerance in banana seedlings, and the positive effect of SA on chilling tolerance, are mediated by H₂O₂ metabolism (Kang *et al.*, 2003b).

SA also plays important roles in plant responses to other abiotic stresses such as salt and osmotic stresses (Borsani *et al.*, 2001). SA can induce thermotolerance in the seedlings of *Sinapis alba* (Dat *et al.*, 1998a,b), *Solanum tuberosum* (Lopez-Delgado *et al.*, 1998), *Phaseolus vulgaris*, *Solanum lycopersicum* (Senaratna *et al.*, 2000), and *Arabidopsis* (Larkindale and Knight, 2002; Clarke *et al.*, 2004).

Salicylic acid treatment reduced the toxic effect of cadmium (Cd) on soybean seedlings and this was associated with the development of a general antistress response (Drazic and Mihailovic, 2005). Metwally *et al.* (2003) reported that SA treatments suppressed Cd-induced upregulation of H₂O₂-metabolizing enzymes such as catalase and ascorbate peroxidase, thereby alleviating Cd toxicity in barley (*Hordeum vulgare*) seedlings. SA treatment also ameliorated the damaging effects of other heavy metals, such as Pb and Hg (Mishra and Choudhuri, 1999).

Abiotic stress also affects cell division, thereby suppressing plant growth and development. Wang *et al.* (1998) reported that low temperature treatment increased the expression of a cyclin-dependent kinase inhibitor gene, ICK1, thereby affecting the process of cell division and ultimately plant growth. However, interactions of stress signaling pathways with cell cycle machinery are not well understood. Application of SA to plants under stress affects phytohormone levels and this could be another mechanism of SA mediated plant protection under stressful conditions. Shakirova *et al.* (2003) reported that SA treatment prevented decreases in IAA and cytokinin contents in salinity stressed wheat plants, thereby reducing stress induced growth inhibition. However, ABA accumulation under salinity stress increased further by SA treated than in control seedlings, demonstrating the protection of plants from salinity.

During cellular metabolic processes, toxic active oxygen species (AOS) such as superoxide anion (O₂⁻), hydroxyl radical (OH), and hydrogen peroxide (H₂O₂) are generated in aerobic conditions (Foyer *et al.*, 1994; Asada, 1999) and can cause damage to these cells, a phenomenon known as oxidative stress. When plants are exposed to various environmental stresses, they produce a range of AOS, in large quantities sufficient to disrupt cellular and metabolic functions of the plant. To prevent oxidative injury by scavenging these toxic and reactive oxygen species through the activities of antioxidant enzymes, such as superoxide dismutase (SOD), ascorbate peroxidase (APX), glutathione reductase (GR), peroxidase (POX), catalase

(CAT) and low molecular weight antioxidant compounds like ascorbic acid (AsA) and glutathione (GSH) (Noctor and Foyer, 1998; Asada, 1999). For the survival of the plants, appropriate functioning of the antioxidant system is important i.e. to maintain a balance between AOS production and scavenging (Scebba *et al.*, 1999). Stress tolerance is, therefore, often related with improved antioxidant systems in plants. It seems that treatment with SA enhances plant antioxidant protective systems thereby inducing stress tolerance. Wang and Li (2006) found increased GSH and AsA (resulting from APX and GR activity) under heat or cold stress when plants were treated with SA.

Proline accumulation is a plant stress adaptation mechanism, occurring when plants are exposed to environmental stresses such as drought, salinity, high temperature, nutrient deficiency and exposure to heavy metals and high acidity (Delauney and Verma, 1993; Zaifnejad *et al.*, 1997; Hare *et al.*, 1999). Proline also accumulates in several plants as a response to cold-shock (Koster and Lynch, 1992; Ruiz *et al.*, 2002). It is now known that one of the responses to external SA application that results in plant protection against abiotic stresses is the accumulation of proline. Shakirova *et al.* (2003) also reported enhanced accumulation of proline in wheat seedlings treated with SA, thus contributing to a reduction in the injurious effects of salinity.

The role of Ca^{2+} as a second messenger in plant responses to environmental stresses is well documented (Webb *et al.*, 1996). Under normal conditions, Ca^{2+} level in the cytoplasm of plant cells is very low, however, there is a large amount of Ca^{2+} in vacuoles and intercellular spaces. Environmental stressors induce stress responses in plants through the shift of Ca^{2+} levels in cytoplasm (Poovaiah, 1993). Exposure of plants to a range of environmental stresses often results in a rapid and transient rise in free cytoplasmic calcium concentration $[\text{Ca}^{2+}]_{\text{cyt}}$ in plant cells. Examples of these stresses are cold or heat shock, (Knight *et al.*, 1991; Gong *et al.*, 1998; Plieth *et al.*, 1999; Holdaway *et al.*, 2000), oxidative stress (Price *et al.*, 1994; Kawano and Muto, 2000; Greene *et al.*, 2002), salinity (Delumeau *et al.*, 2000), and anoxia (Bush, 1996). It seems that the SA induces stress tolerance in plants by using Ca^{2+} as a second messenger. Wang and Li (2006) demonstrated SA treated grape plants had higher levels of cytosolic Ca^{2+} than the control plants, following an exposure to stressful levels of heat or cold.

The increase of $[\text{Ca}^{2+}]_{\text{cyt}}$ regulates a range of plant physiological functions leading to adaptation and acclimation of plants to stress. These $[\text{Ca}^{2+}]_{\text{cyt}}$ mediated functions include protein phosphorylation (Monroy *et al.*, 1998), altered gene activity via several regulatory pathways (Ishitani *et al.*, 1997), the appearance of new gene products related to stress adaptations, such as induction of heat shock proteins (Sabehat *et al.*, 1998); in addition

there are changes in plant membrane properties (Tasaka *et al.*, 1996), and changes in secondary metabolism (Zabotin *et al.*, 1998). Free $[Ca^{2+}]_{\text{cyt}}$ also plays a role in the regulation of antioxidant enzymes. It is known that the secretion and activation of guaiacol peroxidase (GPX) is regulated by Ca^{2+} in cultured peanut (Xu and Huystee, 1993).

4. REFERENCES

- Asada, K. 1999. The water-water cycle in chloroplasts: scavenging of active oxygens and dissipation of excess photons. *Annu. Rev. Plant Physiol. Plant Mol. Biol.*, **50**: 601-639.
- Blilou, I., Ocampo, J. A. and Garcia-Garrido, J. M. 1999. Resistance of pea roots to endomycorrhizal fungus or *Rhizobium* correlates with enhanced levels of endogenous salicylic acid. *J. Exp. Bot.*, **50**: 1663-1668.
- Borsani, O., Valpuestan, V. and Botella, M. A. 2001. Evidence for a role of salicylic acid in the oxidative damage generated by NaCl and osmotic stress in *Arabidopsis* seedlings. *Plant Physiol.*, **126**: 1024-1030.
- Broughton, W. J., Zhang, F., Perret, X., and Staehelin, K. 2003. Signals exchanged between legumes and *Rhizobium*: Agricultural uses and perspectives. *Plant Soil*, **252**: 129-137.
- Bush, D. S. 1996. Effects of gibberellic acid and environmental factors on cytosolic calcium in wheat aleurone cells. *Planta*, **199**: 89-99.
- Clarke, S. M., Mur, L. A. J., Wood, J. E. and Scott, I. M. 2004. Salicylic acid dependent signaling promotes basal thermotolerance but is not essential for acquired thermotolerance in *Arabidopsis thaliana*. *Plant J.*, **38**: 432-447.
- Dat, J. F., Lopez-Delgado, H., Foyer, C. H. and Scott, I. M. 1998a. Parallel change in H_2O_2 and catalase during thermotolerance induced by salicylic acid or heat acclimation in mustard seedlings. *Plant Physiol.*, **116**: 1351-1357.
- Dat, J. F., Foyer, C. H. and Scott, I. M. 1998b. Change in salicylic acid and antioxidants during induced thermotolerance in mustard seedlings. *Plant Physiol.*, **118**: 1455-1461.
- Delauney, A. J. and Verma, D. P. S. 1993. Proline biosynthesis and osmoregulation in plants. *Plant J.*, **4**: 215-223.
- Delumeau, O., Paven, M. C. M., Montrichard, F. and Laval-Martin, D. L. 2000. Effect of short-term NaCl stress on calmodulin transcript levels and calmodulin-dependent NAD kinase activity in two species of tomato. *Plant Cell Environ.*, **23**: 329-336.
- Dempsey, D. A., Shah, J. and Klessig, D. F. 1999. Salicylic acid and disease resistance in plants. *Crit. Rev. Plant Sci.*, **18**: 547-575.
- Drazic, G. and Mihailovic, N. 2005. Modification of cadmium toxicity in soybean seedlings by salicylic acid. *Plant Physiol.*, **168**: 511-517.
- Durner, J., Shah, J. and Klessig, D. F. 1997. Salicylic acid and disease resistance in plants. *Trends Plant Sci.*, **2**: 266-274.
- Durrant, W. E. and X. Dong. 2004. Systemic acquired resistance. *Annu. Rev. Phytopathol.*, **42**: 185-209.
- Foyer, C. H., Descourvieres, P., and Kunert, K. J. 1994. Protection against oxygen radicals: an important defence mechanism studied in transgenic plants. *Plant Cell Environ.*, **17**: 507-523.
- Gong, M., van der Luit, A. H., Knight, M. R. and Trewavas, A. J. 1998. Heat-shock induced changes in intracellular Ca^{2+} level in tobacco seedlings in relation to thermotolerance. *Plant Physiol.*, **116**: 429-437.

- Greene, V., Cao, H., Schanne, F. A. X. and Bartelt, D. C. 2002. Oxidative stress-induced calcium signalling in *Aspergillus nidulans*. *Cell Sig.*, **14**: 437-443.
- Hare, P. D., Cress, W. A. and van Staden, J. 1999. Proline synthesis and degradation: a model system for elucidating stress-related signal transduction. *J. Exp. Bot.*, **50**: 413-434.
- Holdaway-Clarke, T. L., Walker, A., Hepler, P. K. and Overall, R. L. 2000. Physiological elevations in cytoplasmic free calcium by cold or ion injection result in transient closure of higher plant plasmodesmata. *Planta*, **210**: 329-335.
- Ishitani, M., Xiong, L., Stevenson B. and Zhu, J. K. 1997. Genetic analysis of osmotic and cold stress signal transduction in *Arabidopsis*: interactions and convergence of abscisic acid-dependent and abscisic acid-independent pathways. *Plant Cell*, **9**: 1935-1949.
- Janda, T., Szalai, G., Antunovics, Z., Horvath, E. and Paldi, E. 2000. Effect of benzoic acid and aspirin on chilling tolerance and photosynthesis in young maize plants. *Maydica*, **45**: 29-33.
- Janda, T., Szalai, G., Tari, I. and Paldi, E. 1999. Hydroponic treatment with salicylic acid decreases the effects of chilling injury in maize (*Zea mays* L.) plants. *Planta*, **208**: 175-180.
- Kang, G. Z., Wang, Z. X. and Sun, G. C. 2003a. Participation of H₂O₂ in enhancement of cold chilling by salicylic acid in banana seedlings. *Acta Bot. Sin.*, **45**: 567-573.
- Kang, G., Wang, C., Sun, G. and Wang, Z. 2003b. Salicylic acid changes activities of H₂O₂-metabolizing enzymes and increases the chilling tolerance of banana seedlings. *Env. Exp. Bot.*, **50**: 9-15.
- Kawano, T. and Muto, S. 2000. Mechanism of peroxidase actions for salicylic acid-induced generation of active oxygen species and an increase in cytosolic calcium in tobacco cell suspension culture. *J. Exp. Bot.* **51**: 685-693.
- Klessig, D. F. and Malamy, J. 1994. The salicylic acid signal in plants. *Plant Mol. Biol.*, **26**: 1439-1458.
- Knight, M. R., Campbell, A. K., Smith, S. M. and Trethewey, A. J. 1991. Transgenic plant aequorin reports the effects of touch and cold-shock and elicitors on cytoplasmic calcium. *Nature*, **352**: 524-526.
- Koster, K. L. and Lynch, D. V. 1992. Solute accumulation and compartmentation during the cold acclimation of puma rye. *Plant Physiol.*, **98**: 108-113.
- Lamb, C. and Dixon, R. A. 1997. The oxidative burst in plant disease resistance. *Annu. Rev. Plant Physiol. Plant Mol. Biol.*, **48**: 251-275.
- Larkindale, J. and Knight, M. R. 2002. Protection against heat stress-induced oxidative damage in *Arabidopsis* involves calcium, abscisic acid, ethylene, and salicylic acid. *Plant Physiol.*, **128**: 682-695.
- Lian, B., Zhou, X., Miransari, M. and Smith, D. L. 2000. Effects of salicylic acid on the development and root nodulation of soybean seedlings. *J. Agron. Crop Sci.*, **185**: 187-192.
- Loh, J., and Stacey, G. 2003. Nodulation gene regulation in *Bradyrhizobium japonicum*: A unique integration of global regulatory circuits. *Appl. Environ. Microbiol.*, **69**: 10-17.
- Lopez-Delgado, H., Dat, J. F., Foyer, C. H. and Scott, I. M. 1998. Induction of thermotolerance in potato microplants by acetylsalicylic acid and H₂O₂. *J. Exp. Bot.*, **49**: 713-730.
- Mahajan, S. and Tuteja, N. 2005. Cold, salinity and drought stresses: An overview. *Arch. Biochem. Biophys.*, **444**: 139-158.
- Malamy, J., Carr, J. P. and Klessig, D. F. 1990. Salicylic acid: a likely endogenous signal in the resistance response of tobacco to viral infection. *Science*, **250**: 1002-1004.
- Malamy, J., Hennig, J. and Klessig, D. F. 1992. Temperature-dependent induction of salicylic acid and its conjugates during the resistance response to tobacco mosaic virus infection. *Plant Cell*, **4**: 359-366.

- Martinez-Abarca, F., Herrera-Cervara, J. A., Bueno, P., Sanjuan, J., Bisseling, T. and Olivares, J. 1998. Involvement of salicylic acid in the establishment of the *Rhizobium meliloti*-alfalfa symbiosis. *Mol. Plant-Microbe Interact.*, **11**: 153-155.
- Metwally, A., Finkemeier, I., Georgi, M. and Dietz, K. J. 2003. Salicylic acid alleviates the cadmium toxicity in barley seedlings. *Plant Physiol.*, **132**: 272-281.
- Mishra, A. and Choudhuri, M. A. 1999. Effects of salicylic acid on heavy metal-induced membrane degradation mediated by lipoxygenase in rice. *Biol. Plant.*, **42**: 409-415.
- Monroy, A. F., Sangwan, V. and Dhindsa, R. S. 1998. Low temperature signal transduction during cold acclimation: protein phosphatase 2A as an early target for cold-inactivation. *Plant J.*, **13**: 653-660.
- Noctor, G. and Foyer, C. H. 1998. Ascorbate and glutathione: keeping active oxygen under control. *Annu. Rev. Plant Physiol. Plant Mol. Biol.*, **49**: 249-279.
- Oostendorp, M., Kunz, W., Dietrich, B. and Staub, T. 2001. Induced disease resistance in plants by chemicals. *Eur. J. Plant Pathol.*, **107**: 19-28.
- Perret, X., Staehelin, C., and Broughton, W. J. 2000. Molecular basis of symbiotic promiscuity. *Microbiol. Mol. Biol. Rev.*, **64**:180-201.
- Pieterse, C. M. J., Pelt, J. A., van. Wees, S. C. M., van. Ton, J., Leon-Kloosterziel, K. M., Keurentjes, J. J. B., Verhagen, B. W. M., Knoester, M., Sluis, I. and van der Bakker, P. A. H. M. 2001. Rhizobacteria-mediated induced systematic resistance triggering, signaling and expression. *Eur. J. Plant Pathol.*, **107**: 51-61.
- Plieth, C., Hansen, U. P., Knight, H. and Knight, M. R. 1999. Temperature sensing by plants: the primary characteristics of signal perception and calcium response. *Plant J.*, **18**: 491-497.
- Poovaliah, B. W. 1993. Biochemical and molecular aspects of calcium action. *Acta Hort.*, **326**: 139-146.
- Price, A. H., Taylor, A., Ripley, S. J., Griffiths, A. and Trewavas, A. J. 1994. Oxidative signals in tobacco increase cytosolic calcium. *Plant Cell*, **6**: 1301-1310.
- Quirino, B. F., and Bent, A. F. 2003. Deciphering host resistance and pathogen virulence: the *Arabidopsis/Pseudomonas* interaction as a model. *Mol. Plant Pathol.*, **4**: 517-530.
- Rab, A. and Saltveit, M. E. 1996. Differential chilling sensitivity in cucumber (*Cucumis sativus*) seedlings. *Physiol. Plant.*, **96**: 375-382.
- Ramanujan, M. P., Abdul Jaleel, V. and Kumaravelu, G. 1998. Effect of salicylic acid on nodulation, nitrogenous compounds and related enzymes of *Vigna mungo*. *Biol. Plant.*, **41**: 307-311.
- Raskin, I. 1992. Role of salicylic acid in plants. *Annu. Rev. Plant Physiol. Plant Mol. Biol.*, **43**: 439-463.
- Ruiz, J. M., Sanchez, E., Garcia, P. C., Lopez-Lefebvre, L. R., Rivero, R. M. and Romero, L. 2002. Proline metabolism and NAD kinase activity in greenbean plants subjected to cold-shock. *Phytochem.*, **59**: 473-478.
- Ryals, J., Uknes, S. and Ward, E. 1994. Systemic acquired resistance. *Plant Physiol.*, **104**: 1109-1112.
- Sabehat, A. P., Lurie, S. and Weiss, D. 1998. Expression of small heat shock proteins at low temperature. *Plant Physiol.*, **117**: 651-658.
- Saltveit, M. E. and Morris, L. L. 1990. Overview of chilling injury in horticultural crops. In: Wang, C.Y., (Ed.). Chilling Injury of Horticultural Crops, CRC Press, Boca Raton, pp. 3-15.
- Sato, T., Fujikaki, H., Ohtake, N., Sueyoshi, K., Takahashi, T., Sato, A. and Ohya, T. 2002. Effect of exogenous salicylic acid on nodule formation of hypernodulating mutant and wild type of soybean. *Soil Sci. Plant Nutr.*, **48**: 413-420.

- Scebba, F., Sebastiani, L. and Vitagliano, C. 1999. Protective enzymes against activated oxygen species in wheat (*Triticum aestivum* L.) seedlings: responses to cold acclimation. *J. Plant Physiol.*, **155**: 762–768.
- Schultze, M., and Kondorosi, A. 1998. Regulation of symbiotic root nodule development. *Annu. Rev. Genet.*, **32**: 33–57.
- Senaratna, T., Touchell, D., Bunn, T. and Dixon, K. 2000. Acetyl salicylic acid (aspirin) and salicylic acid induce multiple stress tolerance in bean and tomato plants. *Plant Growth Regul.*, **30**: 157–161.
- Shakirova, F., Sakhabudinova, A., Bezrukova, M., Fatkhutdinova, R. and Fatkhutdinova, D. 2003. Changes in the hormonal status of wheat seedlings induced by salicylic acid and salinity. *Plant Sci.*, **164**: 317–322.
- Sharma, Y. K., Leon, J., Raskin, I. and Davis, K. R. 1996. Ozone-induced resistances in *Arabidopsis thaliana*—the role of salicylic acid in the accumulation of defense-related transcripts and induced resistance. *Proc. Natl. Acad. Sci. U.S.A.*, **93**: 5099–5104.
- Sudha, G. and Ravishankar, G. A. 2002. Involvement and interaction of various signaling compounds on the plant metabolic events during defense response, resistance to stress factors, formation of secondary metabolites and their molecular aspects. *Plant Cell Tiss. Org. Cult.*, **71**: 181–212.
- Szalai, G., Tari, I., Janda, T., Pestenacz, A. and Paldi, E. 2002. Effects of cold acclimation and salicylic acid on changes in ACC and MACC contents in maize during chilling. *Biol. Plant.*, **43**: 637–640.
- Tasaka, Y., Gombos, Z., Nishiyama, Y., Mohanty, P., Ohba, T., Ohki, K. and Murata, N. 1996. Targeted mutagenesis of acyl-lipid desaturases in *Synechocystis*: evidence for the important roles of polyunsaturated membrane lipids in growth, respiration and photosynthesis. *EMBO J.*, **15**: 6416–6425.
- Tasgin, E., Atici, O. and Nalbantoglu, B. 2003. Effects of salicylic acid and cold on freezing tolerance in winter wheat leaves. *Plant Growth Regul.*, **41**: 231–236.
- van Spronsen, P. C., Tak, T., Rood, A. M. M., van Brussel, A. A. N., Kijne, J. W. and Boot, K. J. M. 2003. Salicylic acid inhibits indeterminate-type nodulation but not determinant-type nodulation. *Mol. Plant-Microbe Interact.*, **16**: 83–91.
- Wang, H., Qi, Q., Schorr, P., Cutler, A. J., Crosby, W. L. and Fowke, L. C. 1998. Ick1, a cyclin-dependent protein kinase inhibitor from *Arabidopsis thaliana* interacts with both Cdc2a and CycD3, and its expression is induced by abscisic acid. *Plant J.*, **15**: 501–510.
- Wang, L.-J. and Li, S.-H. 2006. Salicylic acid-induced heat or cold tolerance in relation to Ca²⁺ homeostasis and antioxidant systems in young grape plants. *Plant Sci.*, (In Press).
- Webb, A. A. R., Mcainsh, M. R., Taylor, J. E. and Hetherington, A. M. 1996. Calcium ions as intracellular second messengers in higher plants. *Adv. Bot. Res.*, **22**: 45–96.
- Xu, Y. and Huystee, R. B. 1993. Association of calcium and calmodulin to peroxidase secretion and action. *J. Plant Physiol.*, **141**: 141–146.
- Yalpani, N., Enyedi, A. J., Leon, J. and Raskin, I. 1994. Ultraviolet light and ozone stimulate accumulation of salicylic acid, pathogenesis-related proteins and virus resistance in tobacco. *Planta*, **193**: 372–376.
- Zabotin, A. I., Barisheva, T. S., Zabolina, O. A., Larskaya, I. A., Lozovaya, V. V., Beldman, G. and Voragen, A. G. J. 1998. Alterations in cell walls of winter wheat roots during low temperature acclimation. *J. Plant Physiol.*, **152**: 473–479.
- Zaifnejad, M., Clark, R. B. and Sullivan, C. Y. 1997. Aluminum and water stress effects on growth and proline of sorghum. *J. Plant Physiol.*, **150**: 338–344.

Chapter 7

STRESS AND ANTISTRESS EFFECTS OF SALICYLIC ACID AND ACETYLSALICYLIC ACID ON POTATO CULTURE TECHNOLOGY

H.A. LOPEZ-DELGADO¹, I.M. SCOTT² AND M.E. MORA-HERRERA¹

¹ Programa Nacional de Papa, Instituto Nacional de Investigaciones Forestales Agrícolas y Pecuarias (INIFAP), Metepec, Méx. 52141, A. P. 1-4. México; ² Institute of Biological Sciences, University of Wales, Aberystwyth, Ceredigion, SY23 3DA, UK.

Abstract: Our own research has found a number of potentially useful effects of medium supplementation with salicylate on *in vitro* potato microplants. These useful effects are obtained taking advantage of the stress and antistress effects of salicylic acid on plants. Growth inhibition is a common stress effect of salicylic acid on plants. This stress effect can be directed to culture technology, including promotion of *in vitro* tuberization and growth retardation during *in vitro* germplasm preservation. Antistress effects of salicylates can also be used in a planned manner to improve *in vitro* culture technology and hardening in potato with different applications like induction of thermotolerance during thermotherapy for virus elimination, organogenesis for micropropagation, and induction of tolerance to freezing and heat in microplants after transplanting to soil, in glasshouse trials. Tolerance to late blight (*Phytophthora infestans*) in potato has also been observed in field. We have also induced some of these effects in microplants by treatment with H₂O₂ which is consistent with evidence associating salicylate and H₂O₂ as endogenous signaling molecules. Stress and antistress effects appeared to be mediated by some antioxidant enzymes especially catalase, and by H₂O₂ accumulation. The use of salicylates would have agricultural relevance to culture technology and field crops.

Key words: Freezing tolerance, growth inhibition, *in vitro* germplasm preservation, *in vitro* tuberization, micropropagation, organogenesis, potato, thermotolerance

1. INTRODUCTION

The potential application of salicylates in the potato crop has been tested in the National Potato Program, Instituto Nacional de Investigaciones Forestales Agrícolas y Pecuarias (INIFAP), Mexico. We first tested salicylates on *Solanum cardiophyllum*, a wild potato species with high resistance to drought and late blight, (Niederhausen and Mills, 1953; Gray and Hughes, 1978; Galindo, 1982). One of the problems in the domestication of this species is the phenotypic characteristic of long stolons, which make the harvest of the tubers difficult. This fact motivated a study of the effect of salicylates on the *in vitro* growth of nodal explants of this species. Acetylsalicylic acid (ASA) was found to inhibit growth and induce *de novo* shoot organogenesis (Lopez-Delgado *et al.*, 1990). *In vitro* tuberization was also observed (Lopez-Delgado, 1987).

Salicylates have been tested at INIFAP as, while developing alternative methods for micropropagation. ASA was shown to be more effective than salicylic acid and sodium salicylate to induce *in vitro* organogenesis in 10 advanced breeding clones (Lopez-Delgado, 1993b; Flores-Tena, 1993). It was demonstrated that induction of *in vitro* organogenesis by ASA is potentially useful for getting virus-free plants of PVX in 10 advanced breeding clones (Marin-Fuentes, 1992) and the number of virus-free plants was enhanced, depending on the medium and temperature used. Salicylic acid (SA) also enhances heat tolerance and virus elimination during thermotherapy of potato microplants (Lopez-Delgado *et al.*, 2004).

Organogenesis induced by salicylates has also been tested in relation to somaclonal variation (Mora-Herrera, 1991). The potential application of salicylates on *in vitro* germplasm preservation at 8 °C using ASA was demonstrated (Lopez-Delgado, 1998b). Our research was intended to develop a fuller understanding of the physiology and potential of ASA in potato biotechnology.

2. *IN VITRO* TUBERIZATION

The production of *in vitro* tubers represents a method to export disease-free potato genotypes (Estrada *et al.*, 1986). A major problem with export of *in vitro* microplants is that if they are kept in the dark for longer than 3 weeks during transit, they will die. *In vitro* tubers allow the phytosanitary benefits of *in vitro* export without the technical problems of shipping the green plants. On being received, *in vitro* tubers can be maintained *in vitro* for further micropropagation or can be transplanted into pots to provide donor plants for the production of conventional cuttings. *In vitro* tubers have

been recommended not only for micropropagation and international distribution, but also for germplasm storage (Wang and Hu, 1985; Kwiatkowski *et al.*, 1988).

While searching for inhibitors of jasmonate biosynthesis Koda *et al.* (1992) found, by chance, that SA and ASA induced tuberization of potato stolons *in vitro* and (at relatively high concentrations) on whole plants, under non-inductive environmental conditions. In other effects of ASA in potato, it was reported (Nickell, 1991) that control potato plants, under field conditions, showed tubers with an average sucrose content of 2.64 %, whereas ASA-treated potatoes had only 2.14 %. This response improved the fry colour status of potato tubers when processed for industry.

We used ASA because even though ASA is a derivative of SA it did not occur naturally and has often been found to be more effective than the parent compound in tissue culture systems (Saxena and Rashid, 1980; Carswell *et al.*, 1989; Shetty *et al.*, 1992), suggesting (Pierpoint, 1994) either that it is active *per se* or that it is a more effective way of delivering free SA to its target site.

Solanum cardiophyllum is characterized with extremely long internodes, and this characteristic motivated Lopez-Delgado (1987) to test the effect of ASA on the growth of nodal cuttings *in vitro* of this wild potato species. ASA induced growth inhibition in a dose-response manner. Bearing in mind that growth inhibition is a common property of some PGRs known to induce tuberization, the effect of ASA on induction of tuberization was also tested. The optimum concentration for tuberization was 10^{-5} M.

The effect of ASA on the growth of microplants of *Solanum tuberosum* and *S. cardiophyllum* in the induction of tuberization was examined, considering:

a) The tuber formation involves suppression of the axial growth and radial expansion of the tuberizing organ (van Es and Hartmans, 1981; Larry *et al.*, 1985; Vreugdenhil and Stuik, 1989). So it was considered that:

b) The growth inhibiting effect of ASA (Jain and Srivastava, 1981; Cleland and Ben-tal, 1982; Lopez-Delgado 1987; Roggero and Pennazio, 1988; Manthe *et al.*, 1992) could contribute to the induction of tuberization in the potato species *S. tuberosum* and *S. cardiophyllum*.

2.1 Growth inhibition by ASA

The effect of ASA on the growth of Russet Burbank microplant shoots from single node cuttings was studied. There was a significant inhibitory effect of ASA (Figure 1) at 10^{-4} - 10^{-3} M (Lopez-Delgado and Scott, 1997). Although the microplants cultured in 10^{-3} M ASA showed a strong stem growth inhibition by 67-80%. This concentration was not used for the

tuberization experiments, due to the drastic effect (Figure 1) on the percentage of surviving explants (46%). Both ASA concentrations, 10^{-4} and 10^{-3} M, reduced significantly the microplant mass; the ASA concentration of 10^{-3} M reduced the microplant mass by 60-71 %. Therefore, a slightly lower range of concentrations was tested for the tuberization experiments.

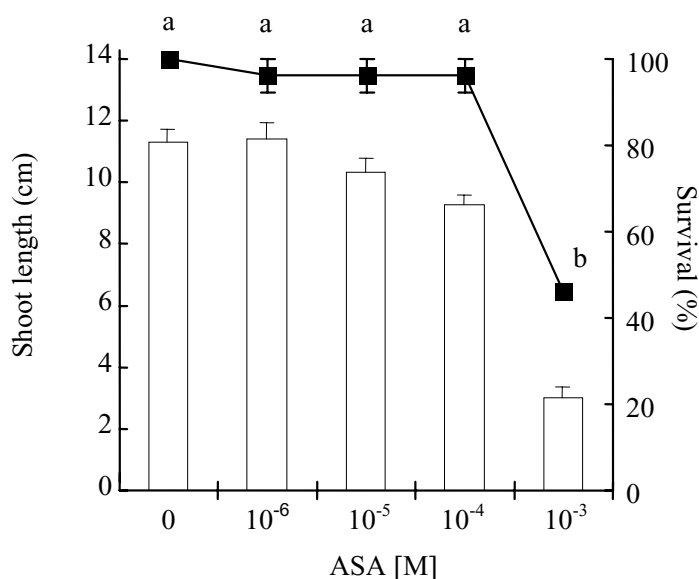

Figure 1. Effects of ASA concentrations, added to the propagation medium, on mean shoot length \pm SE (bar graph), and on mean percentage of survival \pm SE (line graph) of potato microplants after 40 days of culture. Data points with same letter were not significantly different at 5% level.

2.2 Effect of ASA concentration on tuberization

The objective of this experiment was to determine, if ASA could induce tuberization on microplant shoots. Shoot explants were subcultured from the micropropagation medium onto media with a range of ASA concentrations, ranging from 10^{-5} to 7.5×10^{-4} M.

Temperature conditions were found to be important. A temperature of 25 ± 1 °C inhibited the tuberization induction in cv. Russet Burbank. After 90 days of culture, none of the ASA treatments or the control showed microtubers. Abnormally, the explants showed etiolation and some of them developed branches.

Tuberization was observed in this cultivar at a temperature of 18 ± 1 °C. Strong tuberization was obtained when the growth retardant CCC of the

standard CIP medium was replaced by ASA at 10^{-5} - 7.5×10^{-4} M (Figure 2). All shoot explants survived in this concentration range. No branching or etiolation was observed.

The size of tubers produced in ASA was at least as great as those produced in CCC. Tubers produced at concentrations of 10^{-5} - 5×10^{-4} M had a significantly greater mean weight than the control, cultured in CCC. All tubers produced on the CIP medium and on ASA were subcultured onto propagation medium, and after 70 days showed 100 % germination.

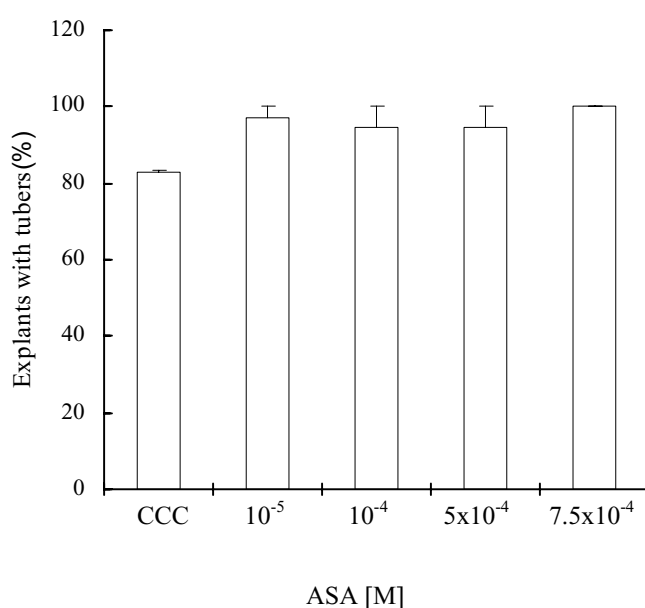

Figure 2. Percentage of tuberized microplant shoot explants (\pm SE) after 60 days of culture on CCC (ie. on CIP medium, which contains CCC, 500 mg l^{-1} and BAP, 5 mg l^{-1}), or on various ASA concentrations that were substituted for CCC in the CIP medium. Results for the different treatments were not significantly different.

2.3 Effect of ASA, CCC and BAP on tuberization

The ASA concentration of 7.5×10^{-4} M was used in these experiments, while CCC and BAP concentrations were as in the standard CIP medium. The explants were incubated at 18 ± 1 °C. The effects of ASA, CCC and BAP on the induction of Russet Burbank microtubers, singly and in combination, were compared in more detail, testing the following treatments: 1. CCC + BAP (standard), 2. ASA + BAP, 3. BAP, 4. ASA, 5. CCC, 6. Basal medium (without CCC and BAP). Figure 3 shows that each of the treatments achieved its maximum percentage of explants with tubers

following a similar rate of tuberization. After 40 days of incubation in total darkness, no further increase in the percentage of explants with tubers was observed. Assessment of tuberization after 60 days, therefore, represented the final tuberization percentage. The medium containing ASA+BAP was highly effective in the induction of tuberization, and was not significantly different to the standard CIP medium (Figure 3). The two PGRs used in combination in the standard CIP medium were also tested individually: BAP by itself induced 22-66 % of explants with tubers, whereas CCC by itself was ineffective. ASA by itself induced 61-72 % of tuberization. All tubers showed subsequent germination. Microplants were found to produce one main tuber on the apex. Some tubers produced on lower buds were less than 100 μg , and as they were not useful for propagation purposes. These small

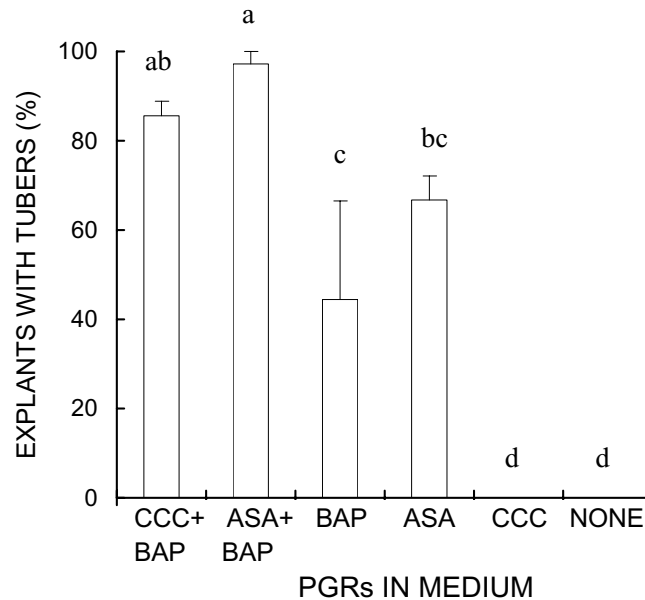

Figure 3. Percentage of tuberized microplant shoot explants (\pm SE), after 60 days of culture on media with various PGRs. Bars with same letter were not significantly different at 5% level.

tubers were not included in the results. The medium without PGRs was ineffective for tuberization. Tubers produced on BAP or ASA independently were at least as large and heavy as the tubers obtained in BAP+ASA and CCC+BAP.

The growth of Russet Burbank microplant shoots from the single node explants on the propagation medium was found to be significantly inhibited by the addition of ASA at 10^{-4} - 10^{-3} M (Figure 1). Although the explants cultured in 10^{-3} M ASA showed the strongest growth inhibition (80%), this concentration was considered too high for the tuberization experiments, because it also had a drastic effect on the percentage of surviving explants (Figure 1).

We demonstrated for the first time the induction by ASA of tuberization of axillary buds of *S. tuberosum* microplants. The induction of microtubers on *S. tuberosum* cv. Russet Burbank by ASA was compared with the widely used CIP tuberization medium, which contained two PGRs: the cytokinin BAP, and the growth retardant CCC (Estrada *et al.*, 1986). The advantage of using this medium as a standard was that by substituting ASA for CCC it allowed comparison of ASA as a growth inhibitor in the induction of tuberization; other tuberization media use different kinds of PGRs and were not equally suitable for the purpose of comparison. The full CIP medium was highly effective in microtuber induction, as expected. Manipulation of the PGR content of the CIP medium showed that: (i) no tuberization occurred in the absence of PGRs at the end of the 60 days (ii) BAP alone caused tuberization of a substantial percentage of the microplants; (iii) CCC alone was ineffective. Since CCC alone was ineffective in inducing tuberization, and ASA alone induced 72 % of tuberized explants, this suggests an additional effect of ASA to the growth inhibition, in the induction of tuberization (Figure 3).

Replacement of both PGRs in the CIP medium with ASA (7.5×10^{-4} M) resulted in more tuberization than with BAP alone. A new tuberization medium combining the two PGRs (i.e. BAP and ASA) that were most effective individually and were even more effective than the standard CIP medium in the present study. With the new medium, no more time of incubation than with the standard CIP medium was required to achieve the highest percentage of tuberization. Some media required longer periods of incubation, i.e. 3 to 5 months (Hussey and Stacey, 1984; Garner and Blake, 1989; Suttle and Hulstrand, 1994). This suggests that ASA could find application in potato seed production schemes as an economical alternative or extra component for currently used tuberization media. Significant differences were observed in the weight of tubers produced in ASA, compared with the control. In further research, it could be investigated if these differences are associated with starch content. ASA could affect the sugar metabolism and sucrose formation in microtubers, since parenchyma cortex of stem microplants previously incubated in ASA showed abundant starch grains, which were not present in the control plants (Flores-Tena,

1993). Nickell (1991) also reported that potato plants under field conditions, treated with ASA had less content of sucrose than the control plants.

The criteria used to choose the range of ASA concentrations for the induction of tuberization were growth inhibition with minimum effect on the percentage of survival of the explants (Figure 1). In the present study with *S. tuberosum*, the percentage of survival was not affected by culturing the explants in MS medium with 8% sucrose, BAP and ASA at 7.5×10^{-4} M, but the percentage of survival was significantly reduced at ASA concentrations higher than 10^{-4} M on 3% sucrose (Figure 1). It is worth mentioning that in *S. cardiophyllum* a percentage of survival of 47 % was observed using MS supplemented with 3% sucrose, ASA (10^{-4} M), IAA and BAP, whereas the same ASA concentration was lethal when 0.5% sucrose with no other PGRs, present in the medium (Lopez-Delgado, 1987). Further studies could be performed to investigate the possible protective effect of sucrose when using ASA at different concentrations. Other phenolic compounds, including coumarin, have been reported as plant growth inhibitors (Kefeli and Kutacek, 1977) and tuberization promoters in potato (Stallknecht, 1972). The original rationale of Lopez-Delgado (1987) for testing the effects of ASA on tuberization was that growth inhibition is a common property of PGRs known to induce tuberization, a point made by Pelacho *et al.* (1994).

Imbalance of the auxin-cytokinin ratio could be important for the tuberization induction. It is interesting to highlight that ASA alone induced tuberization in its own right in a similar way as BAP alone. Koda *et al.* (1992) stated that derivatives of benzoic acid which are inhibitors of the auxin transport, could have tuber-inducing activity.

One possible type of mechanism for the growth inhibition and tuberization effects of ASA is suggested by evidence that H_2O_2 concentrations *in vivo* may be modified by salicylate treatments (Chen *et al.*, 1993). A change in H_2O_2 concentration might affect auxin turnover by the postulated IAA oxidase route (Zheng and van Huystee, 1992; Gazarayan *et al.*, 1996), although the significance of this pathway remains uncertain (Normanly *et al.*, 1995).

Plants obtained from microtubers produced in the presence of ASA could be tested against phytopathogens, such as potato virus X (PVX) and potato virus Y (PVY) in a seed production scheme, since it has been claimed that salicylates mediate defence responses in pathogenesis (Chen *et al.*, 1993; Demprey and Klessig, 1994; Gazarayan *et al.*, 1996).

Sano and Ohashi (1995) discovered a complex signal network, involving G-proteins, in which the levels and actions of cytokinins, jasmonates and salicylates are interactively regulated. In transgenic plants with high cytokinin levels, an abnormal 'signal switch' seemed to occur, resulting in the production of SA instead of jasmonic acid after wounding (Sano and

Ohashi, 1995). There may be a complex relationship between the three types of PGR that induce *in vitro* tubers, and that the application of one of these PGRs might influence the endogenous levels and effects of the other PGRs in a manner that may or may not be natural.

Comparing the tuber-inducing effects of ASA with those of the standard CIP tuberization medium, ASA is potentially useful on its own and in combination with BAP, to be used in potato seed production schemes. ASA can be substituted for the growth inhibitor CCC in the standard tuberization medium tested, but the fact that ASA alone induced about 70 % of tuberized explants, suggests an additional effect of ASA to the growth inhibition in the induction of tuberization.

3. STORAGE OF POTATO MICROPLANTS *IN VITRO* IN THE PRESENCE OF ACETYLSALICYLIC ACID

Maintenance of collections of *in vitro* microplants of *Solanum* species is a standard method of germplasm storage at centres which conserve genetic diversity of the crop and distribute pathogen-tested genotypes in national and international programs (Lizarraga *et al.*, 1989; Roca *et al.*, 1989; Dodds *et al.*, 1991). However, high labour is required, for the maintenance of tissue culture collection. Stock microplants grown under optimal condition require subculture every 4-8 weeks. To induce slow growth and extend intervals between subcultures, culture condition can be modified (Westcott, 1981; Lizarraga *et al.*, 1989; Dodds *et al.*, 1991; Harding, 1991), usually with a high concentration of mannitol to reduce the medium water potential so that the microplants are subjected to growth-inhibiting osmotic stress also, in combination with reduced temperature (6-10 °C) gives results superior to either treatment, applied alone (Ng and Ng, 1991). Slow-growth techniques can permit cultures of many *Solanum* genotypes to remain viable for approximately 1 year or more (Withers *et al.*, 1990; Ng and Ng, 1991). However, growth of *in vitro* potato microplants on high-mannitol medium cause hyper-methylation of DNA, this change might be stable during meiosis, causing altered phenotypes in subsequent generations (Harding, 1994). As the objective of a germplasm collection is to preserve specific genetic material, this possibility raises concerns.

In the *in vitro* potato germplasm storage facility at INIFAP, intervals between subcultures are extended by growth at 8°C, in the presence of 4% mannitol. The time for which a potato microplant will remain healthy under this conditions before subculture depends on genotype, but is generally 6-18 months. We investigated ASA as an alternative to mannitol for slow-growth

under *in vitro* storage, of *S. tuberosum* L. microplants at 8°C. The potential of ASA for extending intervals between subcultures at conventional potato micropropagation temperatures, for use in centres lacking reduced-temperature facilities (Lopez-Delgado *et al.*, 1998b). The effects of 100 µM ASA on grown retardation of cv. Alpha microplants cultured for 4 months at 8°C is only slightly greater than that on the standard 4% mannitol medium, and decreased at higher ASA concentrations (250, 500 and 750 µM). The survival is 100% in either 100 µM ASA or 4% mannitol medium, whereas in highest concentration of ASA it is 90%. Therefore, 100 µM ASA was selected for further assessment using clones of 100 genotypes, for comparing to 4% mannitol (Lopez-Delgado *et al.*, 1998b).

Clones of each genotype cultured at 8°C on mannitol or 100 µM ASA storage media, was assessed after 8 and 12 months, early symptoms of senescence indicating that subculture was desirable (Table 1), were shown on both media by clones of 39 and 43 genotypes after 8 and 12 months respectively (Tables 2-3). Clones of the remaining 18 genotypes showed no symptoms of deterioration after 12 months on either medium, followed by subculture and a further 2 months on the same media, no significant differences in survival rates on mannitol or ASA storage media were observed at any of this stage. The range of storage periods, therefore, proved to be comparable on either medium. However, an important difference between the two media was that microplant morphologies on the ASA medium were always normal, whereas abnormal stunted morphologies frequently developed on the mannitol medium. Ninety percent of genotypes stored on mannitol showed propensity to develop abnormalities, which are undesirable because difficulties may be encountered in the recovery of normal plantlets from such phenotypes (Dodds *et al.*, 1991).

Table 1. Media used for recovery of potato clones from *in vitro* storage conditions.

Recovery medium	Composition
A	MS, GA ₃ (28.8 µM), glycine (133 µM), nicotinic acid (406 µM), pyridoxine HCl (2.43 mM), sucrose (2.5%), agar (0.6%)
B	MS, ASA (250 µM), GA ₃ (28.8 µM), glycine (133 µM), nicotinic acid (406 µM), pyridoxine HCl (2.43 mM), sucrose (2.5%), agar (0.6%)
C	MS, IAA (5.7 µM), BAP (4.4 µM), sucrose (3%), agar (0.7%)
D	MS, GA ₃ (11.5 µM), IAA (5.7 µM), BAP (4.4 µM), sucrose (3%), agar (0.7%)

Table 2. Recovery of 39 potato in vitro clones following storage for 8 months in slow-growth conditions (8°C on medium supplemented with either 4% mannitol or 100 µM ASA). Single node explants (8 per clone) were incubated for a further 30 days on media A to D (Table 1) at 18°C, and exhibited the survival and growth parameters listed. All explants formed roots.

Clones recovered from mannitol medium		
Recovery medium	% of explants surviving	Mean increase in fresh weight (mg)
A	100.0	49.26
B	98.0	9.10
C	97.8	13.35
D	90.5	65.40

Clones recovered from ASA medium		
Recovery medium	% of explants surviving	Mean increase in fresh weight (mg)
A	99.1	62.14
B	95.0	44.30
C	93.1	41.55
D	91.5	179.14

Table 3. Recovery of 43 in vitro potato clones following storage for 12 months in slow-growth conditions (8°C on medium supplemented with either 4% mannitol or 100 µM ASA). Single node explants (8 replicates per clone) were incubated for a further 30 days on medium A (Table 1) at 18°C, and exhibited the survival and growth parameters listed. All explants formed roots.

Storage medium	% of explants surviving	Mean increase in fresh weight (mg) ± SE
Mannitol	100.0	261.7 ± 35.7
ASA	100.0	222.3 ± 35.5

On the other hand, 39 micro-plants stored for 8 months in mannitol or ASA showed good recovery after 30 days on recovery MS media and survival rate was nearly 100% (Table 2). Growth of the ASA-treated explants was stronger than those stored in mannitol. Vigorous regrowth was noted when explants from *S. cardiophyllum* microplants, cultured in the presence of ASA, were subcultured onto ASA-free medium (Lopez-Delgado and Carrillo-Castañeda, 1996). Prolonged culture on ASA had no adverse effect on the yield of minitubers on plantlets transferred to glasshouse cultivation. Intervals between the subcultures of the plants stored at 18 °C could be prolonged to 5.5-6 months by culture on either mannitol or ASA media. Microplants cultured on ASA did not exhibit frequent phenotypic abnormalities, noticed in microplants on mannitol medium.

4. INDUCTION OF SHOOT ORGANOGENESIS BY ACETYL SALICYLIC ACID

The phenotypic characteristic of long stolons, of *S. cardiophyllum*, a wild potato species which makes the harvest of the tubers difficult, motivated a study of the effect of salicylates on the *in vitro* growth of nodal explants of this species (Lopez-Delgado *et al.*, 1990).

The effect of ASA on the growth inhibition of axillary buds was tested on plants cultured *in vitro* and in the induction of morphogenesis. In all the experiments Murashige and Skoog (1962) modified medium was used as basic medium. Five concentrations of ASA, were used in order to find growth inhibition as dose-response. The same explants were subcultured in basic medium without ASA. After 30 days, they recovered the growth and produced multiple shoots. Later on, buds were incubated in two concentrations of ASA (10^{-4} and 10^{-5} M), for four periods of time (7, 14, 21 and 30 days), and at the end of each period the plants were transferred to MB for 30 days. The best results were obtained where the buds were incubated in ASA 10^{-5} M for 30 days, getting 42.8 % of shoot forming explants (Table 4). Similar results were obtained in *S. tuberosum*. Nodal cuttings of *S. tuberosum* were incubated in MS medium with two concentrations of ASA for 30 days and then subcultured into the same medium without ASA for 30 days. After this period, 100% of the explants, previously incubated in both ASA concentrations, had organogenesis of shoots, in contrast with only 50% in the control explants (Mora-Herrera, 1991).

Table 4. Induction of organogenesis by ASA. Explants were incubated in presence of the salicylate for 30 days and subcultured without ASA for 30 days more.

Treatment ASA [M]	<i>Solanum cardiophyllum</i>			<i>Solanum tuberosum</i>		
	% elongation inhibition	<i>de novo</i> Sprouts / explant (Mean)	%explants with <i>de</i> <i>novo</i> sprouts	% elongation inhibition	<i>de novo</i> Sprouts/ explant (Mean)	% explants with <i>de</i> <i>novo</i> sprouts
0	0.0	0	0	0.0	2	5.2
10^{-6}	3.3	11	100	15.03	10	29.41
10^{-5}	13.39	4	42.8	10.8	14	41.10
10^{-4}	36.65	2	32.4	34.02	15	15.62

5. INDUCTION OF THERMOTOLERANCE IN POTATO MICROPLANTS BY ACETYLSALICYLIC ACID

Studying the effect of ASA on virus translocation during thermotherapy under *in vitro* conditions, it was incidentally noticed that salicylate might be having an effect on thermotolerance of microplants. The induction of thermotolerance by ASA in potato microplants was demonstrated and optimised (Lopez-Delgado *et al.*, 1998a). In accordance with temperatures commonly used in potato for *in vitro* thermotherapy to get virus-free plants, temperatures of 42 and 35 °C were chosen to carry out the experiments. It was proposed that SA can bind to and inhibit catalase activity, that leads to enhanced production of H₂O₂, which induces pathogenesis related (PR) genes and has a central role, as a diffusible signal, for the induction of defence genes (Foyer *et al.*, 1997; Luna *et al.*, 2004). Inactivation by SA of purified catalase was confirmed (Chen *et al.* 1995, Conrath *et al.*, 1995). The induction of catalase activity was examined in relation to the thermotolerance effect of ASA considering that catalase may have a central role in the action of SA during plant responses to disease signaling responses and oxidative stress.

5.1 Effect of ASA on thermotolerance of test explants

5.1.1 Heat shock (42 °C) 24 hours after subculture

In order to test whether ASA could induce thermotolerance, explants (nodal cuttings) one day after subculture were chosen to carry out the heat treatments, considering that at this stage of culture, the explants were more sensitive to heat. These explants were taken from microplants after 3-7 weeks of incubation in ASA at 10⁻⁶ and 10⁻⁵ M. The concentrations of 10⁻⁶ and 10⁻⁵ M were tested for the heat shock (HS) experiments, since these concentrations did not affect the growth and percentage of survival, as shown in previous results. Control test explants from parental microplants of any age on ASA-free medium showed little or no survival of HS treatment at 42 °C for 15.25 h; however, explants from both ASA concentrations had much higher survival rates than the controls (Figure 4). The highest percentages of survival were observed in test explants from microplants grown on 10⁻⁶ M both 3 and 4 weeks old, with 94 % and 72.5 % of survival, respectively (Figure 4).

5.1.2 Heat shock (42 °C) 3 weeks after subculture

To test the effect of ASA on resistance of whole plants to HS, that was applied to microplants after incubation and in presence of ASA. All the treatments showed a high percentage of survival. However, damage was

observed in the ASA-treated microplants. Incubation in liquid medium and then substitution of medium before HS (42 °C, 15.25 h) with the same fresh medium (control), showed 95 % of survival.

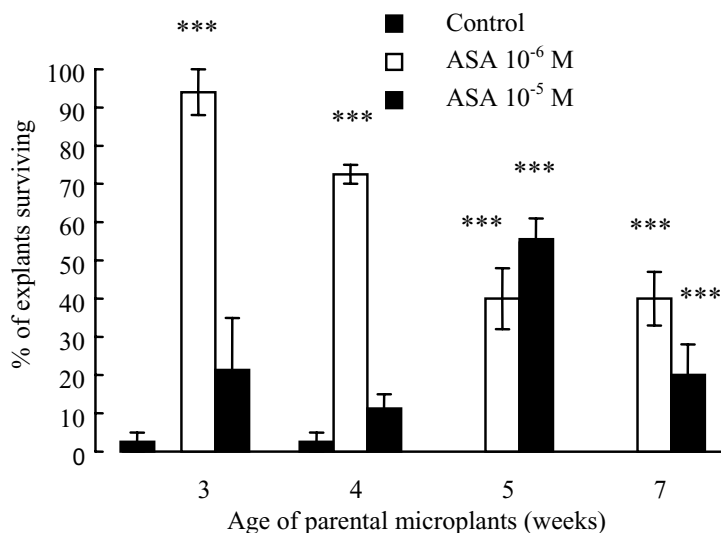

Figure 4. Effect of ASA on resistance to heat shock in cultured potato tissues. Microplants were grown for the periods shown on medium \pm ASA, and then nodal explants were subcultured onto ASA-free medium 24 h before heat shock (42 °C for 15.25 h). Bars = S.E. of means of 3 experiments. Data (***) significantly different to control at each time point $p < 0.001$.

5.1.3 Long-term heat treatment (35 °C) in presence of ASA

Test explants (from microplants, previously cultured on ASA-free medium) were incubated in the presence of ASA at 35 °C for 37 days. The microplants that grew from the explants on ASA-medium were abnormally pale at this temperature. However, at the end of the heat treatment, the microplants on ASA-medium showed significantly higher survival than the controls (Figure 5).

5.1.4 Long-term heat treatment (35 °C) of microplants previously cultured on ASA

Test explants (from microplants, previously cultured on ASA-containing medium) were incubated in the *absence* of ASA at 35 °C for 50 days. The microplants that grew from these explants were normal in colour. Even after 50 days of heat treatment, improved survival was found in the microplants

that grew from explants of previous generation, ASA-microplants. However, controls showed 13.3% survival and microplants treated with ASA, in the previous generation showed 53-60% survival (Figure 6).

5.1.5 Catalase activity in microplants of different ages

Catalase activity was studied in stem from microplants 3, 4, 5 and 7 weeks old. Only the optimal ASA concentration of 10^{-6} M was tested for the catalase measurements. Catalase activity decreased significantly in microplants cultured in ASA for 3 and 4 weeks (Figure 7). However, no significant differences were detected in catalase activity between the controls and the ASA treatments in microplants of 5 and 7 weeks old (Figure 7). Catalase activity was not inhibited by the addition of ASA to these extracts

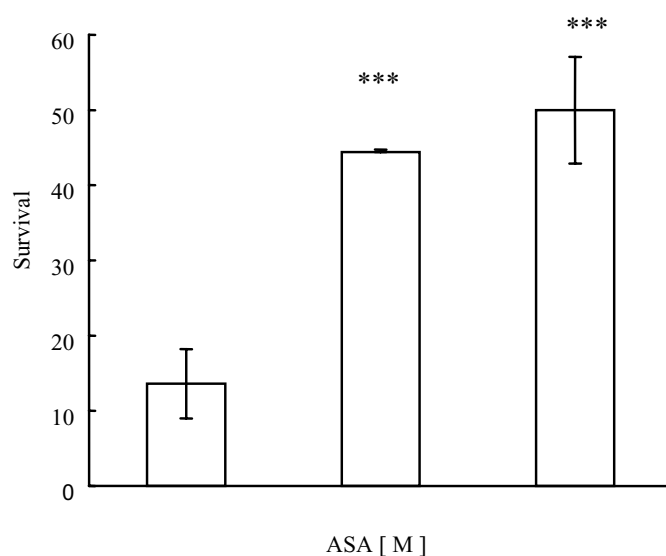

Figure 5. Effect of ASA on long-term thermotolerance of culture potato tissues. Nodal explants from a clonal microplants population were subcultured on medium \pm ASA and then transferred to high temperature (35 °C) for 37 days. Bars = S.E. of means of duplicate experiments (n = 20). Data (***) significantly different from control (p < 0.001).

in the concentration range of 5-20 mM, thus excluding the possibility that the observed reduction in catalase activity was due to an *in vitro* inhibition by ASA co-extracted from the tissues. After 7 weeks, a significant increase of the catalase activity was observed in the ASA treatment, compared with the activity at 3 weeks. At the end of 7 weeks, the values of the catalase

activity in the ASA treatment were not significantly different to the control values observed at 3 and 4 weeks (Figure 7).

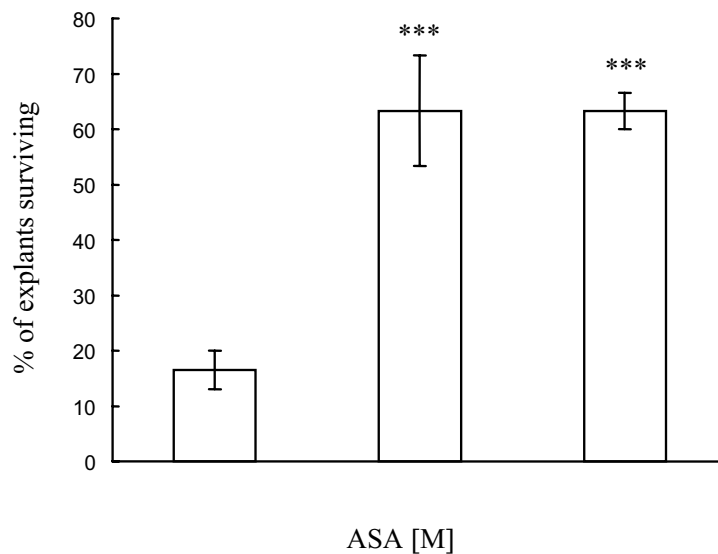

Figure 6. Effect of previous growth on ASA on long-term thermotolerance of cultured potato tissues. Microplants were grown for 30 days on medium \pm ASA and then nodal explants were subcultured onto ASA free medium 24 h before transfer to high temperature (35 °C) for 50 days. Bars =S.E. of means of duplicate experiments. Data (***) significantly different from control at $p < 0.001$.

5.1.6 Effect of subculture on catalase activity

Catalase activity was studied in stems and single node cuttings from microplants, cultured on ASA for 3.5 weeks. The single node cuttings were cultured on propagation medium for 24 h before the catalase analysis. A significant reduction in catalase activity was detected in the stem from microplants, cultured in ASA (Figure 8). A substantial decline of the catalase activity was observed after subculture. Both explants from plants cultured on ASA and control medium showed reduction of activity at 12 and 24 h, after subculture. At the same periods of time, the activities of the explants from plants cultured in ASA were not significantly different to the control explants (Figure 8).

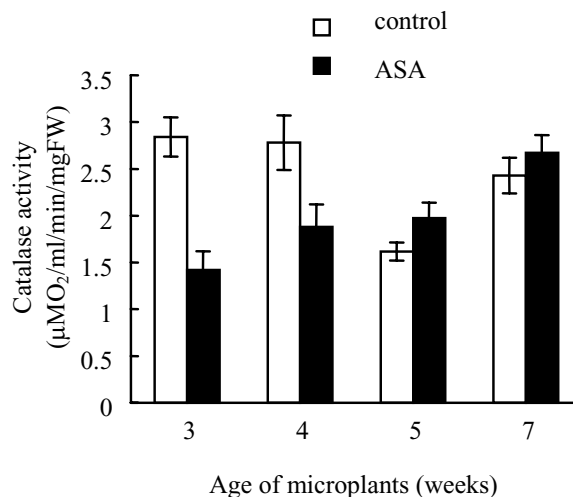

Figure 7. Effect of ASA on catalase activity in potato microplants of different ages. Bars = S.E. of means (n=6-9). Data significantly at $p < 0.0001$.

5.1.7 Catalase activity during the HS

Significant reduction in the catalase activity of the stem was observed in both ASA and control explants, compared with that before the subculture. The reduction in the activity was observed at 1, 5 and 10 h of HS (Figure 8). At 5 h of HS, only the ASA-treated explants without HS showed a significant increase in catalase activity (Figure 8). At 10 h of HS, both the control and ASA-treatments without HS showed significantly higher activity than the treatments with HS (Figure 8). Microplants 3.5 weeks old grown from clonal propagation of nodal cuttings in the presence of ASA (10^{-6} M) showed an increase of 21.9 % in H_2O_2 compared with the control microplants cultured without salicylate (Figure 9).

The results show that it is possible to increase the percentage of survival using ASA not only after periods of heat treatment like 15 hours at $42^\circ C$, but also after longer periods like 37 and 50 days at $35^\circ C$ (Figures 5 and 6). The method described in this work could increase the number of surviving microplants available for further subculture.

The period of incubation in ASA is a determinant in potato of the subsequent response on medium without the salicylate. This reasoning is deduced comparing the effects of ASA in a previous study of *S. cardiophyllum* with the present work in *S. tuberosum*. In *S. cardiophyllum*

multiple shoot organogenesis *de novo* was obtained after the transfer of stem explants from medium with ASA to ASA-free medium (Lopez-Delgado *et al.*, 1990). Four periods of incubation in ASA were tested; 30 days was the optimum period to get the highest rate of organogenesis. In the present work, incubations in ASA for 3, 4, 5, and 7 weeks were tested before the transfer of the test explants to ASA-free medium and application of the heat shock. The highest percentages of survival were obtained on incubating in ASA for 3 and 4 weeks. The organogenesis in *S. cardiophyllum* and thermotolerance in *S. tuberosum* can both be considered as long-term consequences of the *previous* incubation in ASA, perhaps causing a preliminary stress to the tissue. Results suggest that ASA is a stress factor. Supraoptimal effects on the percentage of explants surviving were observed at 10^{-5} M ASA. Incubation in liquid ASA-medium and then replacement with ASA-free medium or the same fresh ASA-medium prior to HS produced microplants with apical necrosis. Probably, at this developmental stage (3 weeks), the additive effect of two stress factors simultaneously, like HS and ASA, yielded apical necrosis (78.9% of microplants); indeed elimination of ASA during HS produced a lower percentage of microplants with necrosis (13% of microplants).

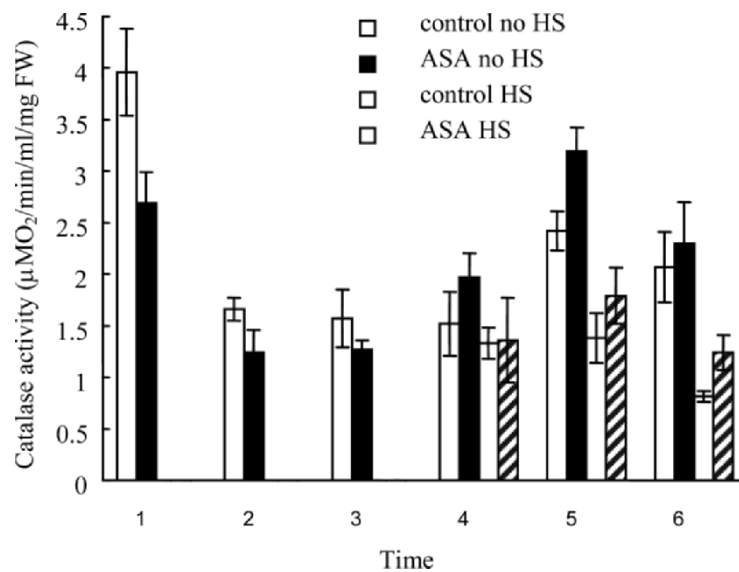

Figure 8. Effects of ASA and heat shock on catalase activity in cultured potato tissues. Microplants were grown for 3.5 weeks on medium \pm ASA 10^{-6} M, and then subcultured for 24 h on ASA-free medium before heat shock at 42 °C for the times indicated. Treatments : 1=Before subculture 2=12h after subculture 3=24h after subculture 4=After 1 h of H.S. 5=After 5 h of H.S. 6=After 10 h of H.S. Bars = S.E. of means (n=6-9). Data significantly at $p < 0.0001$.

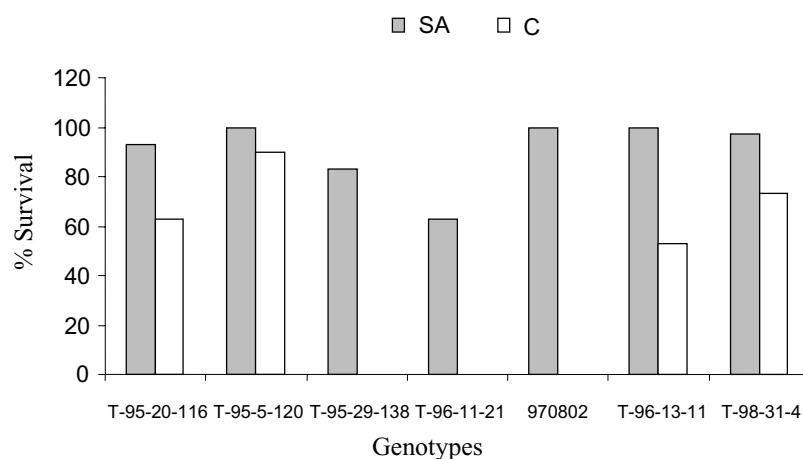

Figure 9. Resistance to thermotherapy (42°C, 30 days) of 7 genotypes of potato microplants, subcultured from in vitro plants grown 4 weeks on propagation medium \pm SA (10^{-5} M). Nodal cuttings were subcultured on to SA-free medium for 24 h and then subjected to thermotherapy (n = 30).

It is interesting to point out that 31% of the surviving test explants from microplants grown on ASA developed new microplants with abnormally thick roots and densely covered with fine root hairs in comparison with the control; this response was not observed in the control and that also only after the HS. This long-term morphogenetic response could be the result of the interaction of the ASA treatment with HS, since morphogenetic responses have been reported to be induced by ASA in different systems (Saxena and Rashid, 1980; Carswell *et al.*, 1989; Lopez-Delgado *et al.*, 1990; Shetty *et al.*, 1992). Perhaps the effect of ASA on growth and root development could also be associated with changes in phosphatase activity, since it was reported that ASA reduced the phosphatase activity in microplants of *S. cardiophyllum* (Lopez-Delgado and Carrillo-Castañeda, 1996). Similarly, application of two phosphatase inhibitors like okadaic acid and calyculin arrested root growth in *Arabidopsis thaliana*, with an increase in the radial diameter of roots and inhibition of root hair elongation (Smith *et al.*, 1994).

Substantial decline in catalase activity was observed 12 and 24 h after subculture (Figure 8) and the significantly lower catalase in the ASA explants was no longer detected during the subsequent HS. The induction of thermotolerance by ASA observed on potato microplants might be correlated with the significant differences in catalase activity, detected before subculture. The inhibition of catalase activity could be associated with increases in internal level of H_2O_2 , which might have a role as a signal in the induction of thermotolerance, as it has been proposed that H_2O_2 is a signal in the induction of resistance to pathogens (Baker *et al.*, 1993; Chen *et al.*,

1993, 1995; Levine *et al.*, 1994; Conrath *et al.*, 1995; Low and Merida, 1996) and chilling (Prasad *et al.*, 1994).

6. SALICYLIC ACID ENHANCES HEAT TOLERANCE AND VIRUS ELIMINATION DURING THERMOTHERAPY OF POTATO MICROPLANTS

The modern production systems of basic and certified seed of potato require the micropropagation of virus-free material and the adoption of fast virus-eradication methods (Faccioli and Colombarini, 1996). In systemically infected plants, viruses tend to be absent from the meristematic tissues and young primordial leaves, so that meristem culture forms the basis of standard virus eradication methods in potato (Salazar and Jayasinghe, 1996). The long-standing empirical observation that virus concentration can be reduced when plants are heat-treated has resulted in thermotherapy becoming a common additional step in virus eradication in potato (Sánchez *et al.*, 1991; Salazar and Jayasinghe, 1996; Fletcher *et al.*, 1998; Rosenberg, 2000). Chemotherapy is another option (Fletcher *et al.*, 1998), though is less widely used due to concerns that genetic variation might be caused by the nucleoside analogues employed (Salazar and Jayasinghe, 1996; Zaitlin and Palukaitis, 2000).

Enhanced procedures for thermotherapy of microplants would be useful in potato biotechnology. The thermotherapy treatment depends on the type of virus, present in the plants and the sensitivity of the cultivar to heat. Often plants do not tolerate high temperatures for periods long enough to inactivate the virus, and this limits the number of regenerated individuals available for the virus detection tests (Sánchez *et al.*, 1991; Rosenberg, 2000). We previously demonstrated that acetyl-SA treatment enhanced thermotolerance in potato microplants (Lopez-Delgado *et al.*, 1998). SA is also known to play an important role in plant defence responses to viral infection (Mur *et al.*, 1997; Murphy and Carr, 2002; Takahashi *et al.*, 2002). As a natural hormone, SA is unlikely to raise concerns as a chemotherapeutic agent. We therefore, reasoned that SA held promise as a medium supplement to improve the efficiency of virus eradication in potato microplants. The beneficial effects of culture in the presence of SA on the survival of potato microplants subjected to thermotherapy and on the number of virus-free plants obtained was demonstrated (Lopez-Delgado *et al.*, 2004).

Seven genotypes of PVX(+) potato microplants, from the INIFAP National Potato Program, were cultured for 4 weeks on medium with or without 10^{-5} M SA, then subcultured onto medium without SA for 24 h and

exposed to a standard antiviral thermotherapy treatment at 42°C. At the end of 30 days of thermotherapy, microplants incubated previously in SA showed better survival than the control microplants, with the protective effects of SA being most apparent in the most thermosensitive genotypes (Figure 9). Microplants incubated in SA showed survival rates of at least 40% and up to 100%, while among the control microplants, three genotypes died completely ($n = 30$). Immediately after thermotherapy, surviving microplants were subcultured and their survival re-assessed, after further 30 days (Figure 10). In three thermosensitive genotypes in which all control microplants had already died in thermotherapy (T-95-29-138, T-96-11-21, 970802), 63 to 100% of the SA-treated microplants that survived thermotherapy ($n \geq 12$) were still growing 30 days after the subculture. In all genotypes in which some control microplants had survived thermotherapy, over 93% of the SA-treated population ($n \geq 12$), but as few as 53% of the controls ($n \geq 8$), still survived 30 days after subculture (Figure 10). Therefore, SA enhanced not only tolerance to the 42°C thermotherapy, but also to recovery at 20°C after the subsequent subculture. Moreover, 30 days after the post-thermotherapy subculture, 100% of the surviving SA-treated microplants, but only 40-65% of the controls, were found by ELISA to be free of PVX ($n = 8-30$) (Figure 11).

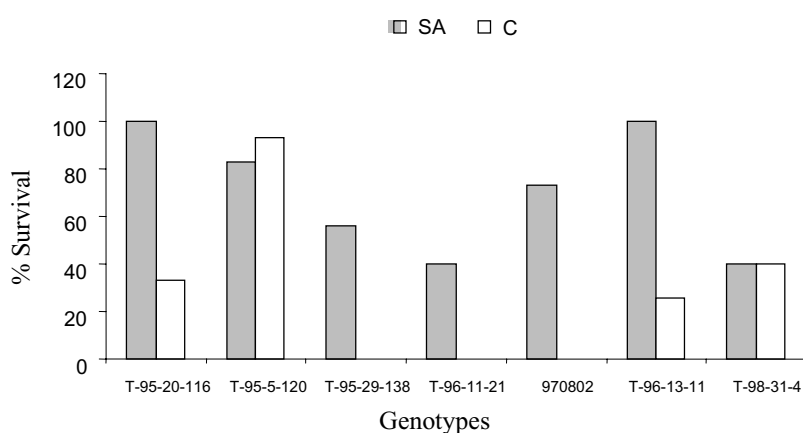

Figure 10. Response to subculture of 7 genotypes of potato microplants after thermotherapy (42°C, 30 days). Prior to thermotherapy, microplants were grown for 4 weeks on propagation medium \pm SA (10^{-5} M). Nodal cuttings were subcultured on to SA-free medium for 24 h and then subjected to thermotherapy. Nodal cuttings from surviving microplants were subcultured and the survival assessed after 30 days ($n = 8-30$).

To confirm, the enhancement of the efficiency of virus eradication by SA, 15 microplants of each of 30 PVX(+) genotypes were subjected to

thermotherapy with or without prior culture on SA as described above. These genotypes were more thermotolerant than the previous group, with $58 \pm 1.0\%$ of controls surviving after 30 days at 42°C , though SA treatment still improved survival, to $64 \pm 0.7\%$. More significantly, the SA treatment prior to thermotherapy resulted in a near-total elimination of PVX ($98 \pm 1.0\%$) from microplants that survived thermotherapy and subsequent culture for 30 days, while only $75 \pm 0.7\%$ of control plants were PVX-free. SA appears to offer a double benefit as a medium supplement in potato tissue culture thermotherapy, enhancing both microplant survival and virus eradication rates. These results confirmed the induction of thermotolerance previously reported (López-Delgado *et al.*, 1998a) by using the natural hormone SA, and demonstrated that how it can integrate into an effective antiviral treatment for PVX(+) microplants, by enhancing their survival during both thermotherapy itself and the recovery period following the post-thermotherapy subculture. Enhancement of heat tolerance by SA or acetyl-SA has now also been demonstrated in a range of other plant species (Dat *et al.*, 1998, 2000; Senaratna *et al.*, 2000; Larkindale and Knight, 2002).

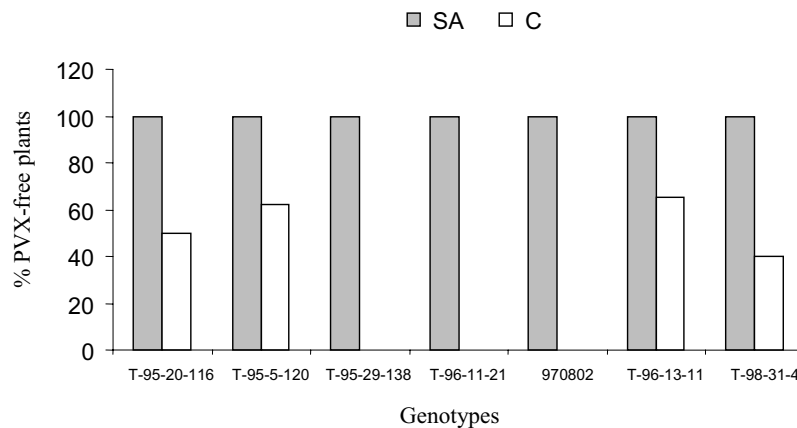

Figure 11. Effect of SA on virus eradication. Prior to thermotherapy, microplants were grown for 4 weeks on propagation medium \pm SA (10^{-5} M). Nodal cuttings were subcultured on to SA-free medium for 24 h and then subjected to thermotherapy. Nodal cuttings from surviving microplants were subcultured, and after 30 days ELISA for PVX was performed ($n = 8-30$).

As a second major benefit of SA treatment, we have demonstrated, for the first time that SA also increases the number of virus-free microplants among thermotherapy survivors. Our hypothesis, that SA might be effective as an antiviral agent in potato biotechnology was based on the extensive literature on SA as a plant defence signal during virus infection (Mur *et al.*,

1997; Murphy and Carr, 2002; Takahashi *et al.*, 2002). Despite its well documented roles in nature, however, there are still relatively few direct agrochemical applications of SA.

The practical utility of heat and SA treatment as demonstrated before (Lopez-Delgado *et al.*, 2004) is strong justification for continued investigation of the interactions between these factors and plant viruses.

7. SALICYLIC ACID AND H₂O₂ FUNCTION BY INDEPENDENT PATHWAYS IN THE INDUCTION OF FREEZING TOLERANCE IN POTATO

Exposure to freezing temperatures leads to extensive tissue damage particularly in chilling-sensitive plants (Janda *et al.*, 1999, 2000; Scebba *et al.*, 1998). Recent studies described improvement in cold tolerance in maize, rice and wheat (Janda *et al.*, 1999; Szalai *et al.*, 2000; Kang and Saltveit, 2002; Tasgin *et al.*, 2003), bean (Ding *et al.*, 2002), cucumber (Kang and Saltveit, 2002), tomato (Senaratna *et al.*, 2000; Ding *et al.*, 2002), banana (Kang *et al.*, 2003), and Persian lilac by exogenous salicylate (Bernard *et al.*, 2002).

There is some evidence about a complex relationship between SA and H₂O₂ signaling in plants; SA can increase H₂O₂ (Rao *et al.*, 1997; López-Delgado *et al.*, 1998a; Dat *et al.*, 1998, 2000) and SA can be induced by H₂O₂ (Chamngpol *et al.*, 1996). However, the physiological relevance of interactions between these two signaling molecules remains poorly characterized and understood. Plants make use of common pathways and components to induce tolerance to a wide variety of environmental stresses (Pastori and Foyer, 2002). This phenomenon, which is known as cross-tolerance, allows plants to adapt to a range of different stresses after exposure to one specific stress. Cross-tolerance results from the action of common signals and elements, which are likely to occur early in the stress response cascade (Pastori and Foyer, 2002). Hydrogen peroxide and SA are strongly implicated in cross-tolerance phenomena (Mittler, 2002; Sudha and Ravishankar, 2002; Neill *et al.*, 2002a, b; Vandenberg *et al.*, 2003). We explored the extent of interaction between these two signaling molecules in the induction of freezing tolerance in two potato cultivars with differences in freezing sensitivity.

Plant 28 days old cultivated *in vitro* on medium containing SA (0.1 mM), increased freezing tolerance in two cultivars of potatoes relative to water-treated controls. Survival after freezing (-6 °C) was increased by up to 76 %

in Alpha, following SA treatment. In Atlantic, however, SA increased by about 93 % (Mora-Herrera *et al.*, 2005).

Plants 28 days old from nodal cuttings treated with H₂O₂ (5 mM) for 1 h also showed freezing tolerance in both cultivars relative to controls. However, the H₂O₂-induced increase in freezing tolerance (130 %) was significant in Atlantic, compared with controls but the effect was not significant in Alpha (Table 5).

SA induced freezing tolerance in two potato cultivars pre-treated at 0.1 mM under *in vitro* conditions, whereas H₂O₂ significantly enhanced tolerance only in the freezing-sensitive cultivar, suggesting that SA generates more potent signal in orchestrating freezing tolerance responses. SA inhibited catalase (Figure 12) and ascorbate peroxidase (Figure 13) activities, causing detectable increases in tissue H₂O₂ (Figure 14) under *in vitro* conditions. SA significantly increased freezing survival in Alpha and Atlantic (Mora-Herrera *et al.*, 2005). Catalase inactivation by SA together with SA-dependent increase in H₂O₂ have been observed earlier (Chen *et al.*, 1995; Rao *et al.*, 1997; López-Delgado *et al.*, 1998a; Dat *et al.*, 1998, 2000; López-Delgado *et al.*, 2004). However, the relationship between H₂O₂ contents, ascorbate peroxidase and catalase activities is complicated by SA-mediated induction of superoxide-generating enzymes. For example, SA has been linked to the induction of plasma membrane O₂-producing enzymes (Kauss and Jeblick, 1996).

Table 5. Effect of salicylic acid (SA) or Hydrogen peroxide (H₂O₂) on freezing tolerance in Alpha and Atlantic. Alpha and Atlantic plants culture *in vitro* for 4 weeks on medium containing 0.1 mM SA and then transferred to soil. After 24h in soil they were subjected to a freezing treatment consisting of exposure to -6 ±1°C for 4 h. In the case of H₂O₂ treatment, Alpha and Atlantic nodal cuttings were initially treated with H₂O₂ (5 mM) for 1 h and then sub-cultured on MS medium for 4 weeks. They were transferred to soil and after 24h they were subjected to a freezing treatment consisting of exposure to -6 ±1°C for 4 h. The symbol (*) indicates significantly different respect to control. Data are expressed as mean values.

	SA		H ₂ O ₂	
	Alpha	Atlantic	Alpha	Atlantic
Control	45.83	22.33	41.66	23.95
Treatment	80.83*	43.08*	40.73	39.81*

The evidence does not support the view that there is a single general mechanism involving SA-mediated changes in ascorbate peroxidase, catalase and H₂O₂ in the acquisition of freezing avoidance in potato, as consistent changes in these parameters were not observed in the two cultivars. The relationship between SA and H₂O₂ would appear to be closer in Atlantic because H₂O₂ induces freezing tolerance in this cultivar. H₂O₂ may comparatively be better in inducing freezing tolerance in species that

are intrinsically more freezing sensitive. While the application of SA can influence both shoot catalase and H₂O₂ contents but there was no consistent trend in these parameters in the two cultivars analysed .

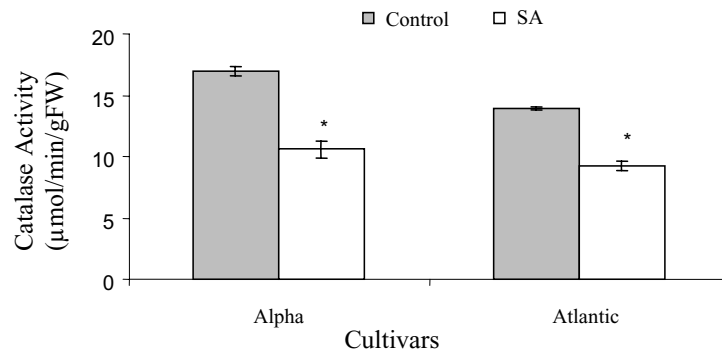

Figure 12. Effect of salicylic acid (SA) on catalase activity in Alpha and Atlantic. Shoot catalase is measured in Alpha and Atlantic plants that have been cultured in vitro on MS medium containing SA (0.1 mM) for 4 weeks.

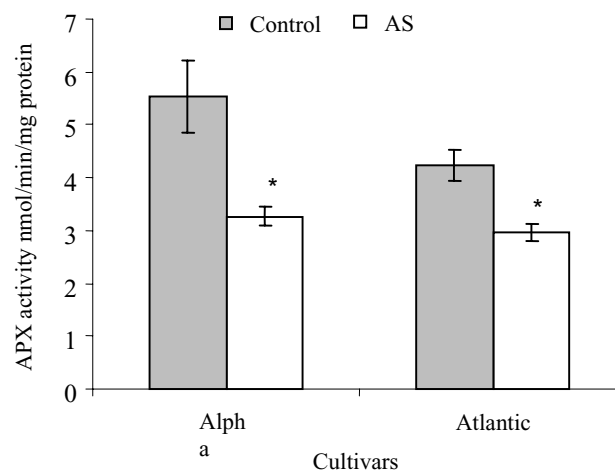

Figure 13. Effect of salicylic acid (SA) on ascorbate peroxidase activity (APX) in Alpha and Atlantic. Shoot APX activity is measured in Alpha and Atlantic plants that have been cultured in vitro on MS medium containing SA (0.1 mM) for 4 weeks.

Our results confirm the potential value of SA and H₂O₂ applications in potato culture technology, especially with regard to aiding micro-plants to avoid freezing-induced damage and death. Our results further illustrate that the standard techniques of potato seed production (including micro-

propagation and culture in soil) exploited here, provide a sensitive tool for the analysis of these mechanisms.

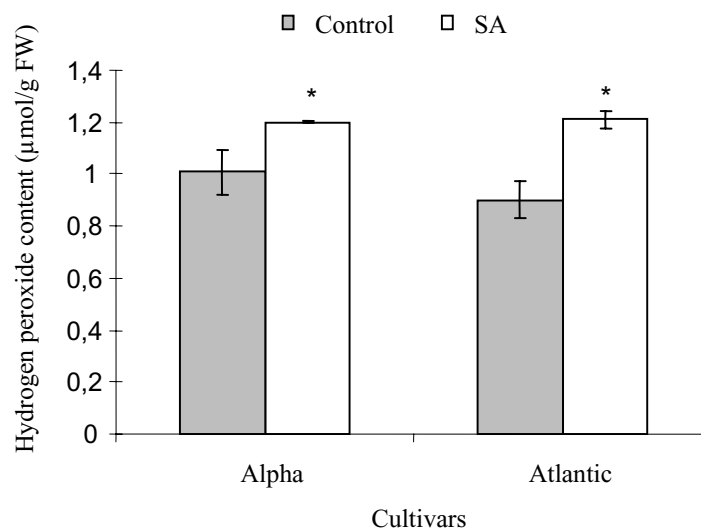

Figure 14. The effect of salicylic acid (SA) on shoot H₂O₂ contents in Alpha and Atlantic. H₂O₂ content is measured in Alpha and Atlantic plants that have been cultured *in vitro* on MS medium containing SA (0.1 mM) for 4 weeks.

8. EFFECT OF ASA ON THE YIELD AND TOLERANCE TO LATE BLIGHT (*PHYTOPHTHORA INFESTANS*)

Under glasshouse conditions ASA was applied at 10^{-4} , 10^{-5} and 10^{-6} M concentrations where tubers were treated with ASA in 3 different ways, a) immersion before planting, b) foliar application and c) immersion + foliar application (Vilaseca, 1999). Under field conditions, only 10^{-5} M was applied. Under glasshouse, the salicylate induced significantly taller stems, and longer roots, in either the foliar and the immersion methods. Foliar application of ASA significantly increased the mass of tubers, up 83.4 % compared with the control but the number of tubers was not affected.

Under field conditions, no differences were found for the weight of tubers. According to the international scale of International Potato Center (CIP) (Fry, 1978), plants treated with ASA lowered the percentage of infection with late blight, as the area under the curve shows (Figure 15).

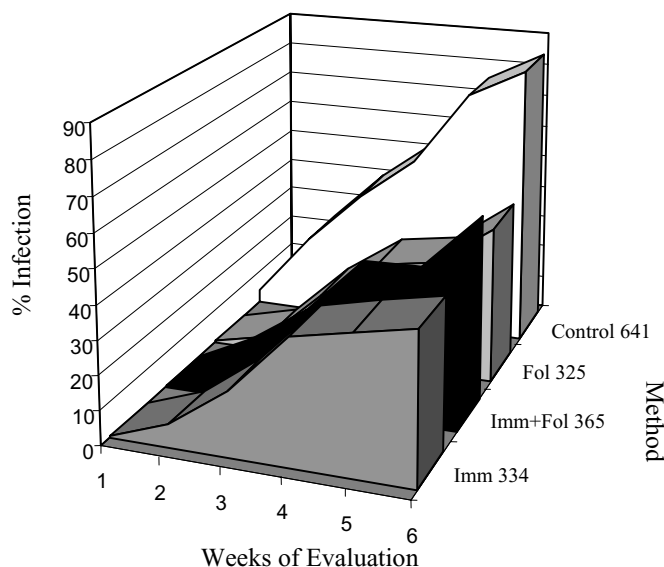

Figure 15. Infection of potato plants by Late blight (*Phytophthora infestans*) cultured under field conditions. Plants were treated with ASA in 3 different ways, a) immersion before planting, b) foliar application and c) immersion + foliar application. The area under the curves represents the value of infection in each treatment. Control plants were not exposed to ASA.

9. CONCLUSIONS

Growth inhibition was a common factor observed during the *in vitro* developmental responses studied throughout this chapter. Both ASA and H_2O_2 induced growth inhibition. It was demonstrated that, with a proper manipulation of the medium and environmental conditions, it was possible to direct the effect on growth inhibition to get the desired *in vitro* developmental response. For the induction of *in vitro* tubers, it was considered that growth inhibition was a common property of PGRs, known to induce tuberization (Pelacho *et al.*, 1994); therefore, it was reasoned that tuberization might result from the growth inhibition effect of ASA on potato microplants. Tubers were obtained by modification of the MS propagation medium with the addition of BAP and a higher sucrose concentration (8%) in the presence of ASA. During the incubation, the temperature was important for the induction of tuberization in combination with total darkness.

Growth inhibition is a requirement for short and medium term *in vitro* germplasm preservation. The growth inhibition effect of ASA can be directed towards *in vitro* germplasm storage. In this case the MS propagation medium was modified with a lower sucrose concentration (0.5%) than for tuberization induction. ASA is potentially useful for both *in vitro* techniques, tuberization and germplasm preservation. The question arises as to the nature of the changes induced by ASA, besides the growth inhibition effect.

Growth inhibition also preceded with the response of thermotolerance, induced by ASA. Additional important factors for the induction of thermotolerance were the time of incubation in ASA and the time after subculture to medium without ASA, before the HS.

An analogy may also be proposed between ASA and other plant growth retardants. ASA, as a growth inhibitor, induced thermotolerance in this work and likewise other growth retardants decreases plant susceptibility to stress. The morphological effects of growth retardants are accompanied by alterations in the developmental and physiological behaviour of treated plants. The most striking changes include reduction of water consumption, retardation of senescence and improved resistance to environmental stress. This induction of thermotolerance by ASA in potato could involve H₂O₂ as a signal (Foyer *et al.*, 1997) as discussed previously. H₂O₂ may be the part of wider stress signalling systems.

In final conclusion, this chapter revealed novel effects of salicylates and H₂O₂ in plant physiology. These effects might involve similar signalling pathways. The model systems developed in this work are suitable for further studies on signalling mechanisms. However, from the biotechnological point of view, the effects of salicylates can be exploited in a planned fashion to induce desirable responses and become a valuable tool in tissue culture technology, and also in potato production technology.

10. REFERENCES

- Baker, C.J., Orlandi, E.W., and Mock, N.M., 1993. Harpin, an elicitor of the hypersensitive response in tobacco caused by *Erwinia amylovora*, elicits active oxygen production of suspension cells. *Plant Physiol.*, **102**: 1341-1344.
- Bernard, F., Shaker-Bazarnov, H., and Kaviani, B., 2002. Effects of salicylic acid on cold preservation and cryopreservation of encapsulated embryonic axes of Persian lilac (*Melia azedarach* L.). *Euphytica*, **123**: 85-88.
- Carswell, G.K., Johnson, C.M., Shillito, R.D., and Harms, C.T., 1989. O-acetyl-salicylic acid promotes colony formation from protoplasts of an elite maize inbred. *Plant Cell Rep.*, **8**: 282-284.
- Chamngopol, S., Willekens, H., Langebartels, C., Van Montagu, M., Inzé, D., and van Camp, W., 1996. Transgenic tobacco with a reduced catalase activity develops necrotic

- lesions and induces pathogenesis-related expression under high light. *The Plant J.*, **10**: 491-503
- Chen, Z. X., Malamy, J., Henning, J., Conrath, U., Sanchez-Casas, P., Silva H., Ricigliano J., and Klessig, D.F., 1995. Induction, modification, and transduction of the salicylic acid signal in plant defence responses. *Proc. Natl. Acad. Sci. USA.*, **92**: 4134-4137.
- Chen, Z., Silva, H., and Klessig, D.F., 1993. Active oxygen species in the induction of plant systemic acquired resistance by salicylic acid. *Science*, **262**: 1883-1886.
- Cleland, C.F., and Ben-Tal, Y., 1982. Influence of giving salicylic acid for different time periods on flowering and growth in the long-day plant *Lemna gibba* G3. *Plant Physiol.*, **70**: 287-290.
- Conrath, U., Chen, Z., Ricigliano, J.R., and Klessig, D.F., 1995. Two inducers of plant defense responses, 2,6-dichloroisonicotinic acid and salicylic acid, inhibit catalase activity in tobacco. *Proc. Natl. Acad. Sci. USA.*, **92**: 7143-7147.
- Dat, J.F., López-Delgado, H., Foyer, C. H., and Scott, I. M., 2000. Effects of salicylic acid oxidative stress and thermotolerance in tobacco. *J.Plant Physiol.*, **156**: 659-665.
- Dat, J.F., López-Delgado, H., Foyer, C.H., and Scott, I.M., 1998. Parallel changes in H₂O₂ and catalase during thermotolerance induced by salicylic acid or heat acclimation in mustard seedlings. *Plant Physiol.*, **116**: 1351-1357.
- Demprey, J., and Klessig, D.F., 1994. Salicylic acid, activate oxygen species and systemic acquired resistance in plants. *Trends Cell Biol.*, **4**: 334-338.
- Ding CK, Wang CY, Gross KC, Smith DL, 2002. Jasmonate and salicylate induce the expression of pathogenesis-related-protein genes and increase resistance to chilling injury in tomato fruit. *Planta*, **214**: 895-901
- Dodds, J.H., Huaman, Z., and Lizarraga, R., 1991. Potato germplasm conservation, In: J.H. Dodds ed., *In vitro* methods for conservation of plant Genetic Resources, Chapman and Hall, London, 93-109.
- Estrada, R., Tovar, P., and Dodds, J.H., 1986. Induction of in vitro tubers in a broad range of potato genotypes. *Plant Cell Tiss. Org. Cult.*, **7**: 3-10.
- Faccioli, G., and Colombarini, A., 1996. Correlation of potato virus S and virus M contents of potato meristem tips with the percentage of virus-free plantlets produced in vitro. *Potato Res.*, **39**: 129-140.
- Fletcher, P.J., Fletcher, J.D., and Cross, R. J., 1998. Potato germoplasm: *in vitro* storage and virus reduction. *New Zeland J Crop Hort Sci.*, **26**: 249-252.
- Flores-Tena, J., 1993. Efecto de tres salicilatos en el desarrollo de plantas de *Solanum tuberosum* cultivadas *in vitro*, ENEP Iztacala, Universidad Nacional Autonoma de México, Bachelor Thesis, 119 pp.
- Foyer, C. H., Lopez-Delgado, H., Dat, J. F., and Scott, I. M., 1997. Hydrogen peroxide- and glutathione-associated mechanisms of acclimatory stress tolerance and signalling. *Physiol. Plant.*, **100**: 241-254.
- Fry, W.E., 1978. Quantification of general resistance of potato cultivars and fungicide effects for integrated control of potato late bight. *Phytopath.*, **68**: 1650-1655.
- Galindo, A.J., 1982. La papita güera. *Naturaleza*, **13**: 175-180.
- Garner, N., and Blake, J., 1989. The induction and development of potato microtubers *in vitro* on media free of growth regulating substances. *Ann. Bot.*, **63**: 663-674.
- Gazarayan, I.G., Lagrimini, L. M., Asby, G.A., and Thorneley, R. N.F., 1996. Mechanisms of indole-3-acetic-acid oxidation by plant peroxidases- anaerobic stoped-flow spectrophotometric studies on horseradish and tobacco peroxidases. *Biochem J.*, **313**: 841-847.
- Gray, D., and Hughes, J.G., 1978. Tuber quality. In: The potato crop, P.M., Harris (ed.), XIII. Chapman and Hill, London, pp 111.

- Harding, K., 1991. Molecular stability of the ribosomal RNA genes in *Solanum tuberosum* plants recovered from slow growth and cryopreservation. *Euphytica*, **55**: 141-146.
- Harding, K., 1994. The methylation status of DNA derived from potato plants recovered from slow growth. *Plant Cell Tiss. Org. Cult.*, **37**: 31-38.
- Hussey, G., and Stacey, N.J., 1984. Factors affecting the formation of *in vitro* tubers of potato (*Solanum tuberosum* L.). *Ann. Bot.*, **53**: 565-578.
- Jain, A., and Srivastava, H.S., 1981. Effect of salicylic acid on nitrate reductase activity in maize seedlings. *Physiol. Plant.*, **51**: 339-342.
- Janda T, Szalai G, Tari I, Paldi E, 1999. Hydroponic treatment with salicylic acid decreases the effects of chilling injury in maize (*Zea mays* L.) plants. *Planta*, **208**: 175-180
- Janda, T., Szalai, G., Antunovics, Z., Horváth, E. and Paldi, E., 2000. Effect of benzoic acid and aspirin on chilling tolerance and photosynthesis in young maize plants. *Maydica*, **45**: 29-33.
- Kang, G.Z., Wang, Z.X., and Sun, G.C., 2003. Participation of H₂O₂ in enhancement of cold chilling by salicylic acid in banana seedlings. *Acta Bot. Sin.*, **45**: 567-573
- Kang, H.M., and Saltveit, M.E., 2002. Chilling tolerance of maize, cucumber and rice seedling leaves and roots are differentially affected by salicylic acid. *Physiol. Plant.*, **115**: 571-576
- Kauss, H., and Jeblick, W., 1996. Influence of salicylic acid on the induction of competence for H₂O₂ elicitation. *Plant Physiol.*, **111**: 755-763
- Kefeli, V.I., and Kutacek, M., 1977. Phenolic substances and their possible role in plant growth regulation, In: Plant growth regulation, P.E. Pilet ed., Springer-Verlag, Berlin, pp 181-188.
- Koda, Y., Takahashi, K., and Kikuta, Y., 1992. Potato tuber-inducing activities of salicylic acid and related compounds. *J. Plant Growth Regul.*, **11**: 215-219.
- Kwiatkowski, S., Martin, M.W., Brown, Ch.R., and Sluis, C.J., 1988. Serial microtuber formation as a long-term conservation method for *in vitro* potato germplasm. *Am. Potato J.*, **65**: 369-375.
- Larkindale, J., and Knight, M.R., 2002. Protection against heat stress-induced oxidative damage in *Arabidopsis* involves calcium, abscisic acid, ethylene, and salicylic acid. *Plant Physiol.*, **128**: 682-695.
- Larry, P., Barker, G.W., and Howarth, M.J., 1985. Development and structure of tubers, In: Potato Physiology Li P.H. ed., Academic Press Inc. USA. pp 123-148.
- Levine, A., Tenhaken, R., Dixon, R., and Lamb, C., 1994. H₂O₂ from the oxidative burst orchestrates the plant hypersensitive disease resistance response. *Cell*, **79**: 583-593.
- Lizarraga, R., Huaman, Z., and Dodds, J.H., 1989. *In vitro* conservation of potato germplasm at the International Potato Center. *Amer. Potato J.*, **66**: 253-269.
- López-Delgado H., and Scott I.M., 1997. Induction of *in vitro* tuberization of potato microplants by acetylsalicylic acid. *J. Plant Physiol.*, **151**: 74-78
- López-Delgado, H, Dat, J.F., Foyer, C.H., and Scott, I.M., 1998a. Induction of thermotolerance in potato micro-plants by acetylsalicylic acid and H₂O₂. *J. Exp. Bot* **49**: 713-720.
- López-Delgado, H., Jimenez-Casas, M., and Scott, I.M., 1998b. Storage of potato micro-plants *in vitro* in the presence of acetyl salicylic acid. *Plant Cell. Tiss. and Org. Cult* **54**:145-152.
- Lopez-Delgado, H., 1993. Micropropagación de papa, Annual report, Programa Nacional de Papa, Instituto Nacional de Investigaciones Forestales y Agropecuarias (INIFAP), México: Metepec.

- Lopez-Delgado, H., and Carrillo-Castañeda, G., 1996. Acetylsalicylic acid: its effects on a highly expressed phosphatase from *Solanum cardiophyllum*. *Biotechnologia Aplicada*, **13**: 186-189.
- Lopez-Delgado, H., Lopez-Peralta, C.G., Villalobos-Arambula, V.M., and Larque-Saavedra, A., 1990. Efecto del acido acetil salicilico en el crecimiento de yemas de *Solanum cardiophyllum* cultivadas *in vitro*. *Agrociencia serie Fitociencia* **1**: 145-159.
- López-Delgado, H., Mora-Herrera, M.E., Zavaleta-Mancera, H.A., Cadena-Hinojosa, M., and Scott, I.M., 2004. Salicylic acid enhances heat tolerance and potato virus X (PVX) elimination during thermotherapy of potato microplants. *Am. J. Potato Res.*, **81**: 171-176.
- Lopez-Delgado, H., 1987. Efecto del acido acetil salicilico en el crecimiento de yemas de *Solanum cardiophyllum* (Lindl.) cultivadas *in vitro*, Tesis de Maestria en Ciencias, Colegio de Postgraduados, México: Chapingo, 86 p.
- Low, P.S., and Merida, J.R., 1996. The oxidative burst in plant defense: function and signal transduction. *Physiol Plant.*, **96**: 533-542.
- Luna, C.M., Pastori, G.M., Driscoll, S., Groten, K., Bernard, S., and Foyer, C. H., 2004. Drought controls on H₂O₂ accumulation, catalase (CAT) activity and CAT gene expression in wheat. *J. Exp. Bot.*, **56**: 417-123.
- Manthe, B., Schulz, M., and Schnabl, H., 1992. Effects of salicylic acid on growth and stomatal movements of *Vicia faba*: evidence for salicylic acid metabolism. *J. Chem. Ecol.*, **18**: 1525-1539.
- Marin-Fuentes, S., 1992. Organogenesis *in vitro* y termoterapia para la obtencion de plantas de *Solanum tuberosum* libres de virus X, Facultad de Ciencias, Universidad Nacional Autonoma de México, Bachelor Thesis, 69 pp.
- Mora-Herrera, M., 1991. Efecto del acido acetil salicilico en el crecimiento de yemas axilares de *Solanum tuberosum* cultivadas *in vitro*. Bachelor Thesis, Facultad de Ciencias, Universidad Nacional Autonoma de México, 115pp.
- Mora-Herrera, M., López-Delgado, H., Castillo-Morales A., and Foyer Ch. Salicylic acid and H₂O₂ function by independent pathways in the induction of freezing tolerance in potato. *Physiol. Plant.* (In Press).
- Mur, L.A.J., Darby, S. F., and Draper, J. 1997. Compromising early salicylic acid accumulation delays the hypersensitive response and increases viral dispersal during lesion establishment in tobacco. *Plant J.*, **12**: 1113-1126.
- Murashige, T., and Skoog, F., 1962. A revised medium for rapid growth and bioassays with tobacco tissue culture. *Physiol. Plant.*, **15**: 473-497.
- Murphy, A.M., and Carr, J.P., 2002. Salicylic acid has cell-specific effects on tobacco mosaic virus replication and cell-to-cell movement. *Plant Physiol.*, **128**: 552-563.
- Neill, S.J., Desikan, R., and Hancock, J., 2002b. Hydrogen peroxide signalling. *Current Opinion in Plant Biology.*, **5**: 388-395.
- Neill, S.J., Desikan, R., Clarke, A., Hurst, D., and Hancock, J.T., 2002a. Hydrogen peroxide and nitric oxide as signalling molecules in plants. *J.Exp. Bot.*, **53**: 1237-1247.
- Ng, S.Y.C., and Ng, N.Q., 1991. Reduced-growth storage of germplasm. In: J.H. Dodds e., *In vitro* methods for conservation of plant genetic resources, Chapman and Hall, London, 11-39.
- Nickell, G.L., 1991. Aspirin and sulfanilamide improve processed potato quality, Proceedings 18th Annual Meeting Plant Growth Regulators Society of America, pp 115-120.
- Niederhauser, J.S., and Mills, W.R., 1953. Resistance of *Solanum* species to *Phytophthora infestans* in Mexico. *Phytopath.*, **43**: 456-457.
- Normanly, J., Slovin, J.P., and Cohen, J.D., 1995. Rethinking auxin biosynthesis and metabolism. *Plant Physiol.*, **107**: 323-329.

- Pastori, G.M., and Foyer, C.H., 2002. Common components, networks and pathways of cross tolerance to stress: the central role of "Redox" and ABA-mediated controls. *Plant Physiol.*, **129**: 460-468.
- Pelacho, A.M., Martin-Closas, L., Campabadal, C., Torres, A., Farran, I., and Mingo-Castel, A.M., 1994. *In vitro* tuberization of potato: effect of several morphogenic regulators in light and darkness. *J. Plant Physiol.*, **144**: 705-709.
- Pierpoint, W.S., 1994. Salicylic acid and its derivatives in plants: medicines, metabolites and messenger molecules. *Adv. Bot. Res.*, **20**: 165-235.
- Prasad, T.K., Anderson, M.D., Martin, B.A., and Stewart, C.R., 1994. Evidence for chilling-induced oxidative stress in maize seedlings and a regulatory role for hydrogen peroxide. *Plant Cell*, **6**: 65-74.
- Rao, M.V., Paliyath, G., Ormrod, D.P., Murr, D.P., and Watkins, C.B., 1997. Influence of salicylic acid on H₂O₂ production, oxidative stress, and H₂O₂-metabolizing enzymes. *Plant Physiol.*, **115**: 137-149.
- Roca, W.M., Chavez, R., Martin, M.L., Arias, D.I., Mafla, G., and Reyes, R., 1989. *In vitro* methods of germ-plasm conservation. *Genome*, **31**: 813-817.
- Roggero, P., and Pennazio, S., 1988. Effects of salicylate on systemic invasion of tobacco plants by various viruses. *J. Phytopath.*, **123**: 207-216.
- Rosenberg, V., 2000. The virus eradication of seed potato initial material. *Plant Breed. Seed Prod.*, **8**: 161-166.
- Salazar, L., and Jayasinghe, U., 1996. Techniques in plant virology in CIP. International Potato Center (CIP), Peru: Lima.
- Sánchez, G.E., Slack, S.A., and Dodds, J.H. 1991. Response of selected *Solanum* species to virus eradication therapy. *Am. Potato J.*, **68**: 299-315.
- Sano, H., and Ohashi, Y., 1995. Involvement of small GTP-binding proteins in defense signal-transduction pathways of higher plants. *Proc. Natl. Acad. Sci. USA.*, **92**: 4138-4144.
- Saxena, P.K., and Rashid, A., 1980. Differentiation of bud-cells on the protonema of the moss *Anoetangium thomsonii*, Effect of aspirin and salicylic acid. *Z. Pflanzenphysiol.*, **99**: 187-189.
- Scebba, F., Sebastiani, L., and Vitagliano, C., 1998. Changes in activity of antioxidative enzymes in wheat (*Triticum aestivum*) seedlings under cold acclimation. *Physiol. Plant.*, **104**: 747-752.
- Senaratna, T., Touchell, D., Bunn, E., and Dixon, K., 2000. Acetyl salicylic acid (aspirin) and salicylic acid induce multiple stress tolerance in bean and tomato plants. *Plant Growth Regul.*, **30**: 157-161
- Shetty, K., Shetty, G.A., Nakaazaki, Y., Yoshioka, K., Asano, Y., and Oosawa, K., 1992. Stimulation of benzyladenine-induced *in vitro* shoot organogenesis in *Cucumis melo* L. by proline, salicylic acid and aspirin. *Plant Sci.*, **84**: 193-199.
- Smith, R.D., Wilson, J.E., Walker, J.C., and Baskin, T.I., 1994. Protein-phosphatase inhibitors block root hair growth and alter cortical cell shape of *Arabidopsis* roots. *Planta*, **194**: 516-524.
- Stallknecht, G.F., 1972. Coumarin induced tuber formation on excised shoots of *Solanum tuberosum* cultured *in vitro*. *Plant Physiol.*, **50**: 412-413.
- Sudha, G., and Ravishankar, G. A., 2002 . Involvement and interaction of various signaling compounds on the plant metabolic events during defense response, resistance to stress factors, formation of secondary metabolites and their molecular aspects. *Plant Cell Tiss. Org. Cult.*, **71**: 181-212.
- Suttle, J.C., and Hulstrand, J.F. 1994. Role of endogenous abscisic acid in potato microtuber dormancy. *Plant Physiol.*, **105**: 891-896.

- Szalai G, Tari, I., Janda, T., Pestenacz, A., and Paldi, E., 2000. Effects of cold acclimation and salicylic acid on changes in ACC and MACC contents in maize during chilling. *Biol Plant.*, **43**: 637-640
- Takahashi, H., Miller, J., Nozaki, Y., Sukanto, Takeda, M., Shah, J., Hase, S., Ikegami, M., Ehara, Y., and Dinesh-Kumar, S.P., 2002. RCY1, and *Arabidopsis thaliana* RPP8/HRT family resistance gene, conferring resistance to cucumber mosaic virus requires salicylic acid, ethylene and novel signal transduction mechanism. *Plant J.*, **32**: 655-667.
- Tasgin, E., Atici, O., and Nalbantoglu, B., 2003. Effects of salicylic acid and cold on freezing tolerance in winter wheat leaves. *Plant Growth Regul.*, **41**: 231-236
- van Es, A., and Hartmans, K.J. 1981. Structure and chemical composition of potato. In: Storage of Potatoes, Rastovski A. van Es A. eds., Centre for Agricultural Publishing and documentation, Wageningen, pp 17-81.
- Villaseca, J.C.B., 1999. Efecto del ácido acetil salicílico y peróxido de hidrógeno sobre algunos componentes del rendimiento y en la tolerancia al tizón tardío *Phytophthora infestans* (Mont.) de bary en papa *Solanum tuberosum* L. Bachelor Thesis, Facultad de Ciencias, Universidad Autónoma del Estado de México, 83pp.
- Vreugdenhil, D., and Struik, P.C., 1989. An integrated view of the hormonal regulation of tuber formation in potato (*Solanum tuberosum*). *Physiol. Plant.*, **75**: 525-531.
- Vreugdenhil, D., and van Dijk, W., 1989. Effects of ethylene on the tuberization of potato (*Solanum tuberosum*) cuttings. *Plant Growth Regul.*, **8**: 31-39.
- Wang, P., and Hu, Ch., 1985. Potato tissue culture and its applications in agriculture, In: Potato Physiology Li P.H. ed., Academic Press, USA: Florida, 503-577.
- Westcott, R.J., 1981. Tissue culture storage of potato germplasm, 2. use of growth retardants. *Potato Res.*, **24**: 343-352.
- Withers, L.A., Wheelans, S.K., and Williams, J.T., 1990. *In vitro* conservation of crop germplasm and the IBPGR databases. *Euphytica*, **54**: 9-22.
- Zaitlin, M., and Palukaitis, P., 2000. Advances in understanding plant viruses and viruses diseases. *Annu Rev Phytopath.*, **38**:117-143.
- Zheng, X., and van Huystee, R.B., 1992. Anionic peroxidase catalysed ascorbic acid and IAA oxidation in the presence of hydrogen peroxide: a defence against peroxidative stress in peanut plant. *Phytochem.*, **31**: 1895-1898.

Chapter 8

SALICYLIC ACID AND REACTIVE OXYGEN SPECIES IN THE ACTIVATION OF STRESS DEFENSE GENES

LORETO HOLUIGUE¹, PAULA SALINAS¹, FRANCISCA BLANCO¹
AND VIRGINIA GARRETÓN²

¹ *Facultad de Ciencias Biológicas, Universidad Católica de Chile, P.O.Box 114-D, Santiago, Chile;* ² *Facultad de Ciencias Naturales, Universidad Santo Tomás, Ejército 41, Santiago Chile.*

Abstract: Activation of salicylic acid (SA) biosynthesis in association with changes in redox homeostasis occurs in plants exposed to diverse biotic and abiotic stresses such as pathogens infection, excess of UV radiation, or increased levels of ozone (O₃). Under these conditions, reactive oxygen species (ROS) and SA are the crucial signals for triggering defense-related processes that are genetically controlled, e.g. programmed cell death (PCD) and the expression of genes that cause defense against stress. Increasing evidence in the yesteryears supports the idea that SA interplays with ROS in the genetic-controlled defense reactions. In this chapter we discuss this evidence, particularly focusing on the expression of stress defense genes. In the first section we are giving an overview about how the changes in SA levels and redox homeostasis occur in the establishment of the defense reaction against stressful conditions. In the second section we will review the information obtained from genetic and biochemical approaches about signaling proteins and promoter DNA elements, involved in the activation of defense genes by SA. Redox controlled transcriptional co-regulators, transcription factors and promoter DNA elements have been shown to mediate SA induced activation of these genes. In the third section we are going to analyze available transcriptome data obtained from *Arabidopsis* plants, either treated with SA or analogs or subjected to stress conditions. We have classified the up-regulated genes according to their known or putative functions. Interestingly, we found genes coding for proteins with antioxidant and detoxifying functions, together with other defense-related functions. Taking together, these evidences suggest that SA plays a role in controlling the cellular redox balance at the onset of the defense response.

Key words: Salicylic acid, ROS, stress defense genes, TGA, NPR1, microarrays, *as-1*, signal transduction pathway

1. INTRODUCTION

1.1 SA is produced in response to environmental stress

It is well established that plants activate SA biosynthesis after being exposed to pathogens infection, excess of UV radiation and increased levels of ozone (O₃) - a model for air pollution (Malamy *et al.*, 1990; Yalpani *et al.*, 1994; Surplus *et al.*, 1998; Rao and Davis, 1999). Requirement for SA in defense reaction against pathogen infection have been clearly demonstrated by using mutant and transgenic plants where SA accumulation, or the function of SA signaling components, is impaired (reviewed in Durrant and Dong, 2004). Transgenic Arabidopsis and tobacco plants expressing the bacterial SA-degrading enzyme salicylate hydroxylase (NahG) are not able to develop an efficient defense reaction, and are therefore more susceptible to damage produced by pathogen infection (Gaffney *et al.*, 1993; Delaney *et al.*, 1994). Arabidopsis NahG plants subjected to stress by ozone also showed alteration in the development of the stress defense reaction (Rao and Davis, 1999).

More recently, it has also been reported that endogenous SA is involved in the plants response to other types of abiotic stresses such as salt and osmotic stress (Borsani *et al.*, 2001), heat (Dat *et al.*, 1998; Larkindale and Knight, 2002; Clarke *et al.*, 2004) and cold (Scott *et al.*, 2004). Moreover, the increase in the endogenous levels of SA have been reported to occur under some physiological conditions such as senescence (Morris *et al.*, 2000).

All these conditions of environmental or physiological stress where SA is accumulated, are known to affect cellular redox homeostasis leading to oxidative stress (Mittler, 2002; Apel and Hirt, 2004). Interestingly, in the last years increasing evidences support the hypothesis that SA plays a crucial role in the control of cellular redox homeostasis in stressed plants. To further discuss this effect of SA, we will first overview some basic aspects of redox homeostasis in plant cells under physiological and stress conditions.

1.2 Redox homeostasis in plant cells

Redox homeostasis in plant cells is maintained by the appropriate balance between reactive oxygen species (ROS) generation and scavenging

mechanisms (Mittler, 2002; Apel and Hirt, 2004). Lately, it has been recognized that increases in ROS levels can not only have a toxic effect inducing cell death by the oxidation of cellular components, but it can also constitute a crucial signal to balance information between metabolism and the environment, as will be discussed below (Foyer and Noctor, 2005).

Under physiological conditions, ROS are continuously produced in plants as byproducts of the metabolic activity in different compartments, mainly chloroplasts, peroxisomes and mitochondria (Figure 1, reviewed in Mittler, 2002; Apel and Hirt, 2004). Associated to the photosynthetic process, ROS can be produced from O_2 in the chloroplast by two main mechanisms: direct photoreduction to a superoxide radical (O_2^-) by the reduced electron transport components associated to PSI; and production of singlet oxygen (O_2^1) by PSII. As a result of the photosynthetic activity, H_2O_2 can also be produced in the peroxisomes, via the photorespiratory pathway that involves the oxygenase activity of Rubisco. These mechanisms for ROS production are used by plants to avoid inhibition of the photosynthetic process, due to an imbalance between rates of light-driven electron transport and CO_2 assimilation (Apel and Hirt, 2004).

Furthermore, H_2O_2 can be produced in the peroxisomes by the fatty acid β -oxidation process, and in the apoplast by oxidases and peroxidases associated to the plasma membrane or to the cell wall. In contrast to mammalian cells, contribution of the respiratory electron transport chain from the mitochondria to basal ROS production in plant cells is negligible (Mittler, 2002). It is believed that the presence of the alternative oxidase, which catalyzes the reduction of O_2 to H_2O , reduces O_2 levels and therefore, limits the generation of ROS in mitochondria (Figure 1; Maxwell *et al.*, 1999).

Plant cells are equipped with five main ROS scavenging systems that are located in the cellular compartments where ROS are produced (Figure 1) (Mittler, 2002; Apel and Hirt, 2004; Foyer and Noctor, 2005). Figure 2 shows in more detail the components involved in each of these scavenging systems. Under physiological conditions, these systems are efficient to keep steady state levels of ROS. Superoxide dismutase (SOD) acts as a first line of defense converting the superoxide radical into H_2O_2 and is present practically in all intracellular compartments and in the apoplast. The other four systems are responsible for H_2O_2 scavenging: the water-water cycle (WW cycle), exclusively found in chloroplasts; the ascorbate-glutathione cycle (A-G cycle), present in chloroplasts, mitochondria, peroxisomes, cytosol and the apoplast; catalase (CAT), mainly present in peroxisomes; and the glutathione peroxidase cycle (GPX cycle), present in cytosol and peroxisomes.

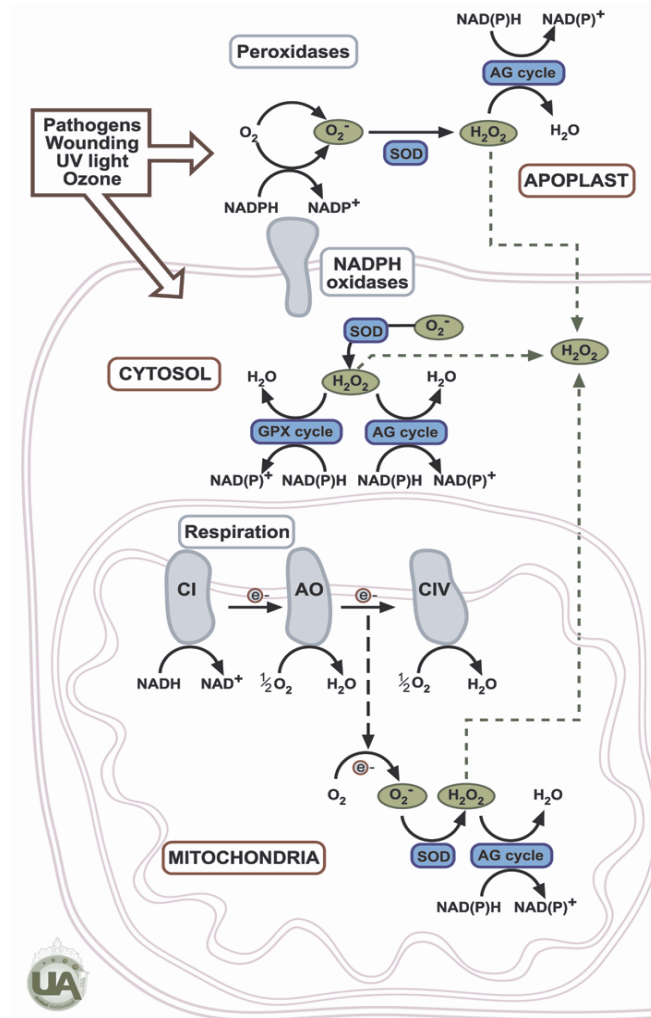
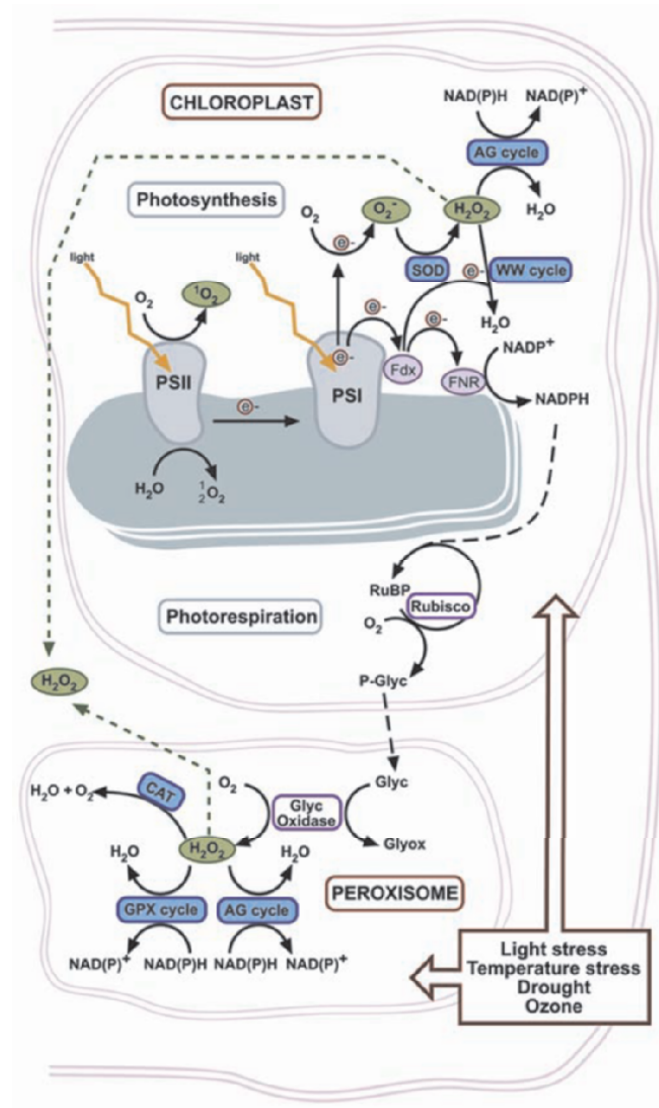

Figure 1. Pathways for ROS production and scavenging in plant cells.

Main mechanisms for ROS production and scavenging, reported to be present in different cellular compartments, are shown. ROS (O_2^- , H_2O_2 , 1O_2) are indicated in green and ROS scavenging mechanisms (superoxide dismutase, SOD; ascorbate-glutathione cycle, AG cycle; glutathione peroxidase cycle, GPX cycle; catalase, CAT; water-water cycle, WW cycle) are in blue (see Figure 2 for components of each scavenging mechanism). In the apoplast, O_2^- can be produced by NADPH oxidases located in the plasma membrane and peroxidases associated to the cell wall. In the mitochondria, production of O_2^- can occur by reduction of O_2 by electrons coming from the respiratory chain (from complex I, CI, ubiquinone and complex III, not shown in detail).



The alternative oxidase (AO) can reduce production of O_2^- in the mitochondria by draining electrons from the respiratory chain and by reducing O_2 levels. In the chloroplast, 1O_2 production can occur from O_2 at the photosystem II (PSII), and production of O_2^- can occur by direct photoreduction of O_2 by electrons from the photosystem I (PSI). The pathway of electrons from PSI to NADPH is also shown (Fdx, ferredoxin; FNR, ferredoxin NADPH reductase). In the peroxisomes, H_2O_2 is produced by the photorespiratory chain via the oxygenase activity of Rubisco and glycolate oxidase. H_2O_2 can cross cellular membranes. The effect of different environmental stress conditions on ROS production in different compartments is indicated.

Briefly (Figure 2), the WW cycle uses a thylakoid-bound ascorbate peroxidase (tAPX), which catalyzes H_2O_2 reduction to H_2O by ascorbate. In this system, reduced ascorbate is regenerated by electrons from PSI. The A-G cycle is probably the most efficient scavenging mechanism to decrease the cellular levels of H_2O_2 . This cycle uses APX and ascorbate to reduce H_2O_2 . The reduced ascorbate is then regenerated by the reducing power of glutathione and NAD(P)H, catalyzed by three enzymes (monodehydroascorbate reductase, dehydroascorbate reductase and glutathione reductase). CAT is the main H_2O_2 scavenging enzyme in peroxisomes that catalyzes the conversion of H_2O_2 into H_2O and O_2 . The GPX cycle uses glutathione to reduce H_2O_2 and then NAD(P)H to regenerate reduced glutathione, catalyzed by GPX and glutathione reductase, respectively.

Plant cells maintain steady state levels of ROS (redox potential) in different compartments, not only by modulating the expression and/or the activity of enzymes involved in ROS scavenging systems, but more importantly, by controlling pool levels of the non-enzymatic components of these systems that act as antioxidant buffers: glutathione, ascorbate and also NAD(P)H (Foyer and Noctor, 2005). Glutathione and ascorbate (vitamin C) are the main hydrophilic antioxidant cellular buffers, while tocopherol (vitamin E) is the major liposoluble antioxidant buffer, being the main scavenger for singlet oxygen generated in the chloroplast (Fobert and Despres, 2005). Interestingly, the antioxidant buffering capacity is much lower in the apoplast and in the thylakoid lumen than in other compartments, facilitating redox signaling in these compartments, as it will be discussed later.

1.3 Biotic and abiotic stress affects redox homeostasis

Biotic and abiotic stress conditions produce an increase in ROS levels, leading to an alteration in the cellular redox homeostasis. For plants to overcome and acquire resistance or tolerance to these adverse environmental conditions, they must tightly control ROS levels to avoid excessive oxidative damage and, at the same time, trigger genetic controlled defense reactions (Overmyer *et al.*, 2003; Foyer and Noctor, 2005).

Different stress conditions activate ROS production in different compartments (Figure 1). Pathogens induce ROS production mainly through NADPH-oxidase activity located in the plasma membrane and peroxidases found in the apoplast (Grant and Loake, 2000). Ozone treatment also

generates an oxidative burst that induces production of H₂O₂ in the apoplast (Pasqualini *et al.*, 2003). However, this effect seems to be secondary to the first increase in ROS levels in the chloroplasts (Joo *et al.*, 2005). Based on the inhibition by DPI, it has also been proposed that NADPH-oxidase could be the main source of ROS production after wounding (Orozco-Cardenas *et al.*, 2001) and UV-B radiation (Mackerness *et al.*, 2001).

In contrast, other environmental conditions of stress are known to increase the levels of ROS in chloroplasts and peroxisomes (Apel and Hirt, 2004). Most of these stress conditions either increase light-driven electron transport (high light intensities) or restrict CO₂ availability (drought or temperature stress), altering the equilibrium between the production of reduced components by the electron transport chain, and the capacity of CO₂ assimilation. This imbalance leads to an increase in ROS production in the chloroplast, associated to PSI and PSII; and in the peroxisomes, associated to photorespiration. Mitochondria has also been described as an important source of ROS production during PCD, as part of the defense response of plants subjected to pathogens and other environmental stresses (Lam *et al.*, 2001).

As described in the previous section, plant cells are equipped with five main ROS scavenging systems, which are controlled by the expression and/or activation of the enzymes involved, and by antioxidant buffers such as glutathione and ascorbate (Apel and Hirt, 2004; Foyer and Noctor, 2005). In addition to these well known systems, plants also have other oxidoreductases that participate in ROS scavenging and, more importantly, in ROS signaling (Foyer and Noctor, 2005). This is the case of a family of protein disulfide oxidoreductases (ie. Thioredoxins, TRX; and glutaredoxins, GRX) that catalyse reversible changes in thiol status of target proteins. These modifications are mainly achieved through dithiol-disulfide changes involving Cys residues (Jacquot *et al.*, 2002). As will be discussed in the third section, these enzymes, together with other oxidoreductases (peroxidases, peroxiredoxins), play a role as H₂O₂ scavengers and as transducers of redox signals to other cellular components.

Interestingly, it has been recently postulated that at the onset of plant defense response to stress, protein disulfide oxidoreductases could be involved in signaling redox changes that trigger PCD and the expression of stress defense genes (Fobert and Despres, 2005; Foyer and Noctor, 2005).

1.4 Interplay between SA and ROS in stress defense response

During the previous years, increasing evidences support the idea that SA interplays with ROS to signal genetic-controlled defense reactions such as

PCD and expression of stress defense genes (Figure 3; Overmyer *et al.*, 2003; Durrant and Dong, 2004; Fobert and Despres, 2005; Foyer and Noctor, 2005).

The idea of an interplay between SA and ROS in the stress defense reaction was first proposed more than 10 years ago (Chen *et al.*, 1993). At that time, the discussion was centered on whether SA produces ROS or ROS promotes SA biosynthesis (Chen *et al.*, 1993; Bi *et al.*, 1995; Neuenschwander *et al.*, 1995; Durner and Klessig, 1996). Nowadays, it is believed that both processes, initially thought to be opposed, are connected in the local and systemic defense responses (Overmyer *et al.*, 2003; Durrant and Dong, 2004).

The local defense response, developed around the infected or damaged cells (after pathogen infection, UV radiation and ozone treatment), usually triggers activation of a PCD process named hypersensitive reaction (HR) (Figure 3; Dangl and Jones, 2001; Lam *et al.*, 2001; Overmyer *et al.*, 2003). Plants infected with avirulent pathogens develop a successful defense response, due to early recognition by disease resistance proteins. In these plants, HR is successful in killing infected cells and restricting pathogen growth and dissemination to the rest of the plant (Lam *et al.*, 2001; Overmyer *et al.*, 2003).

It has been proposed that different combinations of hormones and signals (ROS, SA, NO, ethylene and jasmonic acid) are involved in the initiation, propagation and containment phases of PCD (Overmyer *et al.*, 2003). According to this model, ROS and SA, which accumulate at high levels during HR (Malamy *et al.*, 1990; Rao and Davis, 1999; Pasqualini *et al.*, 2002), could be on a positive feedback loop that amplifies signals in the initiation and propagation phases of cell death (Van Camp *et al.*, 1996; Draper, 1997; Overmyer *et al.*, 2003;). In this local reaction, ROS produced in the apoplast is required (Jabs *et al.*, 1996), but not sufficient (Mur *et al.*, 2005), to trigger PCD. Evidence also indicates that production of ROS in the mitochondria is essential for PCD (Maxwell *et al.*, 2002; Dutilleul *et al.*, 2003). It is believed that the positive feedback loop between SA and ROS in the local defense reaction is produced because H₂O₂ activates biosynthesis of SA via phenylpropanoid pathway (Leon *et al.*, 1995; Durner and Klessig, 1996; Kawano, 2003). On the other hand, high levels of SA not only produce ROS by several mechanisms (Rao *et al.*, 1997; Kawano, 2003), but also inhibit the activity of key antioxidant enzymes such as APX and CAT, leading to an over-accumulation of ROS (Durner and Klessig, 1996). It has been postulated that TRXs could be involved in modulating the activity of these enzymes, being, therefore, crucial for redox signal transduction in PCD responses (Lemaire *et al.*, 2004; Yamazaki *et al.*, 2004).

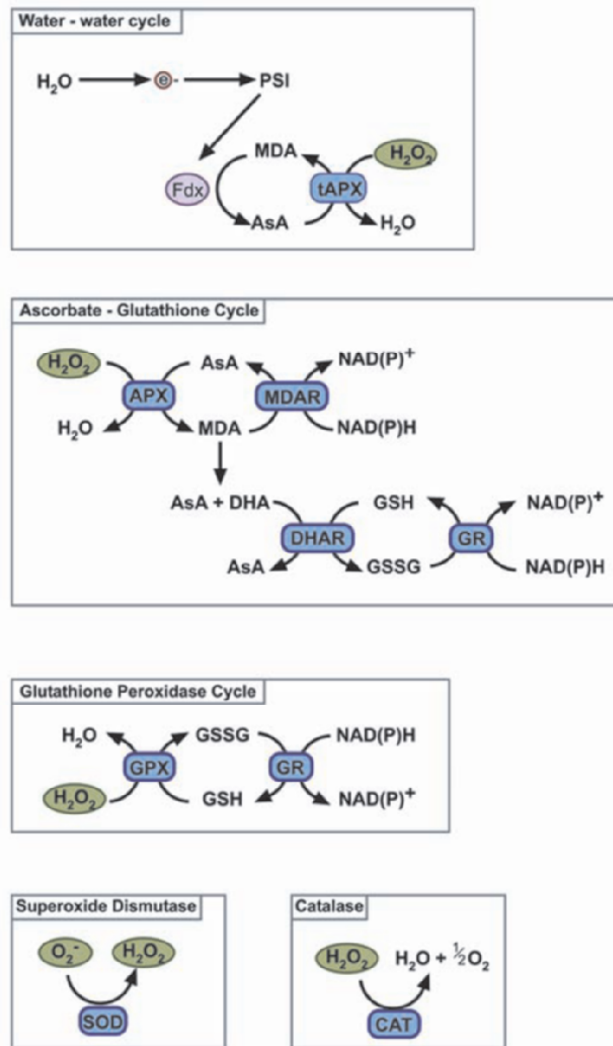

Figure 2. Mechanisms for ROS scavenging in plant cells. Enzymatic (blue) and non enzymatic components of the ROS scavenging systems are shown. ROS (O_2^- , H_2O_2) are indicated in green. The water-water cycle uses a thylakoid-bound ascorbate peroxidase (tAPX) to reduce H_2O_2 by ascorbate (AsA) and electrons from ferredoxin (Fdx) to regenerate AsA. The ascorbate-glutathione cycle uses APX to reduce H_2O_2 by AsA. To regenerate AsA, monodehydroascorbate (MDAR) and $NAD(P)H$, and dehydroascorbate (DHAR) and glutathione (GSH), are used. Then GSH is regenerated by glutathione reductase (GR) and $NAD(P)H$. The glutathione peroxidase cycle uses glutathione peroxidase (GPX) to reduce H_2O_2 by GSH, and GR and $NAD(P)H$ to regenerate GSH. Catalase converts H_2O_2 into H_2O and O_2 . Superoxide dismutase (SOD) converts O_2^- into H_2O_2 . Adapted from (Mittler, 2002).

After the local defense reaction is activated, a signal of unknown nature is transmitted from this tissue to the rest of the plant, to trigger the systemic defense response (Durrant and Dong, 2004). Interestingly, low antioxidant buffering capacity of the apoplast may favor an intercellular long lasting oxidative signal produced during HR in this compartment (Foyer and Noctor, 2005).

The systemic defense response, developed in tissues surrounding HR lesions and in the uninfected distal tissues, is also characterized by a considerably lower increase in SA and ROS levels (Alvarez *et al.*, 1998; Durrant and Dong, 2004). These levels are not high enough as to trigger massive PCD, instead, they are able to activate the expression of defense genes (Figure 3; Surplus *et al.*, 1998; Rao and Davis, 1999; Durrant and Dong, 2004). This response, named systemic acquired resistance (SAR), is responsible for plant survival to pathogen infection, UV radiation and ozone treatment, and for the systemic resistance or tolerance to new stressful stimuli (Yalpani *et al.*, 1994; Durrant and Dong, 2004). SAR and activation of SAR defense genes can be triggered by exogenous treatment of plants with SA, or its functional analogs, supporting the crucial role SA plays in this reaction (Yalpani *et al.*, 1991; Glazebrook *et al.*, 2003). Among defense genes known to be activated by SA, the best characterized are those coding for pathogenesis-related proteins (PRs) (Van Lonn and Van Strien, 1999) and detoxifying enzymes such as glutathione *S*-transferases (GSTs) and glycosyltransferases (GTs) (Edwards *et al.*, 2000; Li *et al.*, 2001) (section 3). Kinetic studies carried out in tobacco and Arabidopsis allowed the grouping of these genes into two different classes according to their kinetics of induction by SA: immediate early (GSTs and GTs) and late genes (i.e. PR-1) (Uknes *et al.*, 1993; Qin *et al.*, 1994; Xiang *et al.*, 1996; Horvath *et al.*, 1998; Uquillas *et al.*, 2004; Blanco *et al.*, 2005).

Although important advances in the understanding of SAR have been achieved in the last few years, the mechanism by which SA and ROS interact in the activation of defense genes, is still not clear (Durrant and Dong, 2004; Fobert and Despres, 2005). It has recently been observed that treatment of plants with a SA analog produces a biphasic effect on the cellular redox potential, being first oxidative and then reductive, as measured by the ratio GSH/GSSG (Mou *et al.*, 2003). Interestingly, as we will discuss in the next section, at least two components of the SA signaling pathway involved in the activation of PR genes have been identified as thiol-based redox sensors (Despres *et al.*, 2003; Mou *et al.*, 2003). The hypothesis that SA can signal these redox modifications by using TRXs or GRXs (Fobert and Despres, 2005) is supported, it will be discussed in the next section, by recent data indicating that SA triggers early activation of some genes coding

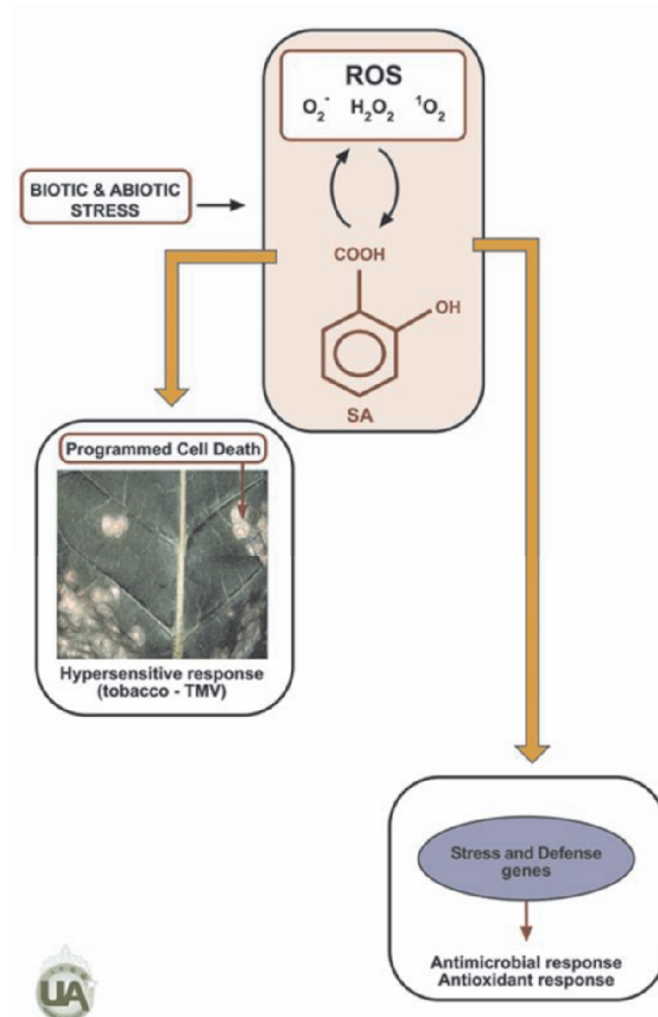

Figure 3. Salicylic acid and ROS are signals for genetic-controlled defense reactions. SA and ROS, both produced by biotic and some abiotic stress, interplay as signals to trigger genetic-controlled defense reactions, such as programmed cell death (PCD) and expression of genes required for the defense response. PCD occurs mainly in the local response (Hypersensitive response, HR) produced during the defense against pathogens and ozone. The expression of stress defense genes occurs systemically and is responsible for the antimicrobial and antioxidant response. This response confers resistance to pathogens or tolerance to abiotic stress in all systemic tissues (SAR).

for these proteins (Blanco, Van Hummelen and Holuigue, unpublished results).

It could be important at this point to provide additional evidence for an antioxidant role of SA, as has been reported in other systems. In rice, a monocotyledonous plant where basal SA levels are two orders of magnitude higher than in *Arabidopsis* or tobacco (5,000-30,000 ng/gfw, compared with <100 ng/gfw), the evidence strongly supports the idea that SA is essential to modulate redox balance and protect plants from oxidative stress (Yang *et al.*, 2004). In fact, SA-deficient transgenic rice plants, that express the bacterial SA degrading enzyme, salicylate hydroxylase, exhibits spontaneous lesion formation in an age- and light-dependent manner, increased susceptibility to oxidative bursts elicited by avirulent pathogens, and are hyperresponsive to oxidative damage caused by methyl viologen treatment (Yang *et al.*, 2004). Besides, in animal cells it has been reported that SA, acting as the main catabolite of aspirin, has a dual role as a proapoptotic and as an antioxidant metabolite. For instance, it has been described that SA promotes apoptosis in a variety of cancer cells, potentiating ROS production (Chung *et al.*, 2003). In contrast, an antioxidant effect has been reported in coronary artery smooth muscle cells infected with human cytomegalovirus (Speir *et al.*, 1998).

Taking together, all the evidences that support the hypothesis that SA plays a crucial role in modulating cellular redox homeostasis in different systems, particularly associated to the onset of a defense response to stress.

2. SIGNALING COMPONENTS IN THE SA PATHWAY

In the past 15 years genetic and biochemical approaches have allowed the identification of several proteins that act as cellular components of the SA transduction pathway. Here we will only review information about those proteins for which a clear participation in the SA signaling has been reported. We will start with a description of proteins that, acting upstream SA, seem to be involved in triggering its biosynthesis. Then we will briefly describe the kinases identified to be part of this pathway. Finally, we will focus our attention on the signaling components directly involved in gene activation mediated by SA, trying to provide a comprehensive picture of the mechanisms involved (Figure 4). Information about other components involved in SAR, can be found in two excellent reviews (Durrant and Dong, 2004; Eulgem, 2005).

2.1 Signaling components upstream SA

Several mutants have been isolated that are impaired in their response to pathogen infection. We will focus on Enhanced Disease Susceptibility 1

(*eds1*), Phytoalexin Deficient 4 (*pad4*), *eds5* (also known as *sid1*) and Isochorismate Synthase 1 (*ics1*) (originally known as *sid2* or *eds16*), because the corresponding mutated genes have been identified (Figure 4). None of these mutants accumulate SA upon infection with virulent or avirulent pathogens, they are all more susceptible to pathogen infection and do not show a clear *PR1* expression after infection.

EDS1 and *PAD4* are similar genes that present some identity to eukaryotic lipases and are required for SA accumulation (Zhou *et al.*, 1998; Falk *et al.*, 1999; Jirage *et al.*, 1999). *eds1* and *pad4* mutant plants are impaired in basal and induced defense response against a broad spectrum of virulent and avirulent pathogens (Feys *et al.*, 2001). The phenotype of *eds1* after pathogen infection is clearly more severe than *pad4*; and *EDS1*, but not *PAD4*, is required for HR (Feys *et al.*, 2001; Wiermer *et al.*, 2005). Interestingly, *EDS1* and *PAD4* are not only required for SA biosynthesis, but also to promote the cell death program characteristic of the HR. The absence of *EDS1* and *PAD4* strongly reduces HR lesion size and the accumulation of ROS (Rusterucci *et al.*, 2001). This last evidence provides a strong genetic link between ROS, SA and pathogen defense.

EDS5/SID1 encodes for a transporter that belongs to the MATE family (Nawrath *et al.*, 2002). Proteins from the same family are responsible for the transport of organic molecules in plants, and the efflux of organic compound in microorganisms (Nawrath *et al.*, 2002). *EDS5* protein is predicted to be localized in the chloroplast and /or the mitochondria and, as Metraux speculated, it would be interesting to elucidate whether *EDS5* is located in the chloroplast, in that case it could be responsible for the transport of SA or its precursors from this organelle to the cytosol (Figure 4; Metraux *et al.*, 2002).

ICS1 encodes for the enzyme isochorismate synthase 1, responsible for the synthesis of SA from chorismate (Wildermuth *et al.*, 2001). Previous to the cloning of *ICS1* in Arabidopsis, the general believe was that SA synthesis in plants occurred only through the phenylalanine ammonium lyase (PAL) pathway. Today, the evidence supports a role for SA biosynthesis in plant defense via both, the *ICS1* and PAL synthetic pathways. Current evidence indicate that SA synthesized through PAL pathway is required for local defense and lesion formation around the site of infection, while SA obtained from the *ICS1* pathway plays a role in SAR (Ferrari *et al.*, 2003). Interestingly, *ICS1* is located in the chloroplast (Wildermuth *et al.*, 2001), suggesting that SA biosynthesis occurs in this organelle (Figure 4), a well known source of ROS within the cell as was discussed earlier.

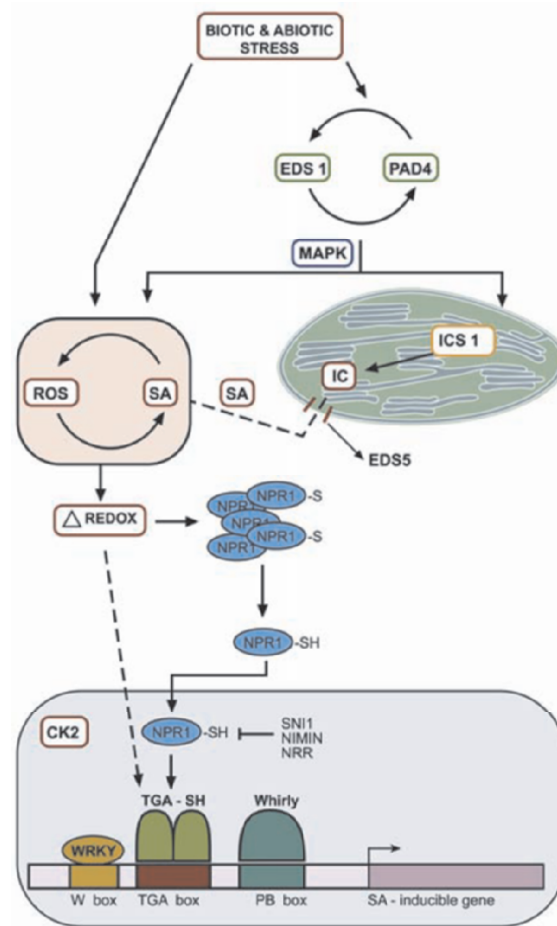

Figure 4. Components identified in the SA signaling pathway. Signaling components directly involved in gene activation mediated by SA are indicated. Proteins identified upstream SA are Enhanced Disease Susceptibility 1 (EDS1) and 5 (EDS5), Phytoalexin Deficient 4 (PAD4), Isochorismate Synthase 1 (ICS1) and MAPKs. ICS1 catalyzes conversion of chorismate into isochorismate (IC), a crucial step of SA biosynthesis, putatively located in the chloroplast.

EDS5 is also putatively located in the chloroplast. Changes in the cellular redox state, controlled by SA and ROS levels, trigger reduction, monomerization and nuclear translocation of NPR1. Reduced monomeric NPR1 binds to TGA factors to increase their DNA binding activity to TGA-boxes. Proteins identified as negative regulators of NPR1 are, Suppressor of NPR1-1 Inducible 1 (SNI1), NPR1/NIM1-interacting protein (NIMIN), Negative Regulator of Resistance protein (NRR). Casein kinase 2 (CK2) has been also reported to act downstream SA in this pathway. Other transcription factors identified are WRKYs, which bind W boxes and Whirly, which recognizes the PB box. TGA boxes, W boxes and PB boxes have been identified as promoter elements in SA-inducible genes.

Adapted from (Durrant and Dong, 2004).

In conclusion, EDS1, PAD4, EDS5 and ICS1 proteins are essential for the SA transduction pathway. They act after the pathogen or the stress signal has been recognized by the plant, and promotes the intracellular accumulation of SA. Interestingly, it is tempting to speculate that lipid signals and the chloroplast may play an important role in SA pathway. Extra evidences in this respect will be added in sections 3 and 4.

2.2 Kinases

Kinases are important signaling components for all the transduction pathways, the SA pathway is not an exception. Two main families of non-receptor kinases, have been functionally linked to SA: Mitotic Activated Protein Kinase (MAPK and its relatives) and Casein Kinase 2 (CK2).

Arabidopsis contains 20 MAP kinases and only 5 MAP phosphatases. The knockout of MAPK4 leads to the accumulation of SA and to enhanced SA-dependent pathogen defense (Petersen *et al.*, 2000), suggesting that MAPK4 negatively regulates this pathway and SA biosynthesis or positively regulates SA degradation. MAPK4, and also MAPK6, are also activated by a range of abiotic stresses (Ichimura *et al.*, 2000). In addition, the tobacco MAP kinases WIPK and SIPK (wounding and SA- induced, respectively) are activated upon pathogen recognition (Asai *et al.*, 2002), and their Arabidopsis orthologs MPK3/6 also function in pathogen resistance (Romeis *et al.*, 1999; Asai *et al.*, 2002). The transduction pathway for a strong bacterial elicitor (flg22) is the first MAPK pathway fully described in Arabidopsis and AtMEKK1, AtMEKK4/AtMEEK5 and AtMPK3/AtMPK6 have a clear role in this pathway (Asai *et al.*, 2002).

CK2 is an ubiquitous kinase that has been found in all eukaryotes where it was looked for. In plants it has been characterized at least in Arabidopsis, maize and tobacco (Collinge and Walker, 1994; Niefind *et al.*, 1998; Peracchia *et al.*, 1999; Salinas *et al.*, 2001). The potential role for CK2 in the SA pathway was first proposed by Hidalgo *et al.* (2001) who demonstrated that in tobacco, SA increases CK2 activity in the nucleus, and that CK2 inhibitors reduce SA-induced binding of nuclear proteins to *as-1* (a promoter sequence responsive to SA, see section 2.4.1). In addition, CK2 inhibitors also reduce the expression of SA-controlled genes in tobacco (Hidalgo *et al.*, 2001). Recently, Kang and Klessig showed that the Arabidopsis TGA2 transcription factor (a SA responsive factor, see section 2.4.1) is phosphorylated by CK2 (Kang and Klessig, 2005). SA stimulates this phosphorylation *in vitro* and CK2 phosphorylation inhibits the binding of TGA2 to its target promoter sequence (Kang and Klessig, 2005). More importantly, experiments done in our laboratory, demonstrated that Arabidopsis plants with reduced CK2 activity, via a dominant negative

approach, are hypersensitive to SA toxicity (Salinas and Holuigue, unpublished results), a phenotype that mimics mutants in other components of the SA pathway such as *npr1* (Cao *et al.*, 1994) and *tga2/tga5/tga6* (Zhang *et al.*, 2003) (see below).

2.3 NPR1

The Non Expressor of *PR* genes 1 (NPR1), also known as NIM1 and SAI1, is an important component identified downstream SA in the defense response to pathogens, which acts as a co-regulator of gene expression (Dong, 2004; Pieterse and Van Loon, 2004). Multiple mutant allelic forms of *npr1* have been identified in different screenings designed to find components of the SA or pathogen defense pathways (Cao *et al.*, 1994; Delaney *et al.*, 1995; Glazebrook *et al.*, 1996; Shah *et al.*, 1997). *npr1* mutants show enhanced disease symptoms when infected with pathogens, they do not get activated *PR* genes by SA and are unable to mount effective SAR or Induced Systemic Resistance (ISR) responses (Pieterse *et al.*, 1998). In addition, *npr1* mutants show reduced tolerance to SA toxicity (SA hypersensitivity) (Cao *et al.*, 1994) and accumulate high levels of endogenous SA upon infection with an avirulent bacteria (Shah *et al.*, 1997), suggesting that NPR1 not only participates in the defense against pathogens but also in detoxification, biosynthesis and/or degradation of SA.

NPR1 is apparently expressed at low levels in all tissues and is slightly induced by SA analogs or pathogen infection (Cao *et al.*, 1997). Under basal conditions, NPR1 forms oligomers through intermolecular disulfide bonds that are sequestered in the cytosol (Mou *et al.*, 2003). After SA levels increase, monomers of NPR1 are formed and move to the nucleus (Kinkema *et al.*, 2000; Mou *et al.*, 2003). In the nucleus, monomeric NPR1 binds to TGA transcription factors (see TGA factors in section 2.4.1), and to other proteins that finally regulate the expression of defense genes (Figure 4) (Dong, 2004). The transition from the inactive to the active form of NPR1 triggered by SA, relays in the reduction of two conserved cysteine residues (Mou *et al.*, 2003). This redox transition of NPR1 implies that plant cells have to modulate their redox potential during the onset of SAR (Fobert and Despres, 2005). Importantly, reducing conditions have to be created within the cell to activate NPR1 and consequently stimulate the expression of genes. As previously mentioned, evidence indicates that SA could be responsible for lowering the redox potential in the cell (Mou *et al.*, 2003). In this context, several genes involved in redox balance and detoxification that are activated earlier by SA without the requirement for NPR1, seem to be proper candidates for decreasing the cellular redox potential (Blanco *et al.*,

2005; Blanco, Van Hummel and Holuigue, unpublished results; Uquillas *et al.*, 2004), see section 3).

Due to the pivotal role played by NPR1 in the defense against pathogens, it is not surprising to find that NPR1 orthologs exist in other species like rice and tobacco (Liu *et al.*, 2002; Chern *et al.*, 2005). The fact that NPR1 overexpression does not seem to produce detrimental secondary effects in plants, and the impressive defense response against a broad spectrum of pathogens seen in NPR1 transgenic plants, make this gene a good target for future biotechnological applications (Cao *et al.*, 1998; Friedrich *et al.*, 2001; Lin *et al.*, 2004; Chern *et al.*, 2005).

The Arabidopsis genome encodes 6 NPR1-like proteins including NPR1 (Liu *et al.*, 2005). NPR4, like NPR1, has also been implicated in pathogen defense (Liu *et al.*, 2005). NPR4 is also localized in the nucleus and interacts with the same spectrum of TGA transcription factors as NPR1 in yeast two-hybrid assays (see TGA factors section for more details). Contrary to *npr1* mutants, in the *npr4-1* mutant *PR1* expression is not significantly affected after SA treatment and *npr4-1* seedlings are not hypersensitive to SA (Liu *et al.*, 2005). In addition, it has been shown that Arabidopsis NPR4, as well as NPR1, participate in the plant defense response against the bacteria *P. syringae* and the fungus *E. cichoracearum*, but not in the response to *P. parasitica* (Liu *et al.*, 2005).

Two other NPR1 like genes, known as BLADE-ON-PETIOLE 1 and 2 (*BOP1* and *BOP2*), have been characterized (Hepworth *et al.*, 2005). Both BOP proteins seem to be redundant and regulate development of leaf and lateral organs (Hepworth *et al.*, 2005). Interestingly, BOP proteins also interact with TGA factors, preferentially with Perinthia, the only characterized Arabidopsis TGA factor that apparently does not participate in the SA-dependent pathogen defense (Hepworth *et al.*, 2005). It has been recently demonstrated that the tobacco TGA2.1 factor does not participate in SA-dependent gene expression either, and it is also required for organ determination during development, especially in flowers (Thurrow *et al.*, 2005).

Till date, there is no available information about the two remaining NPR1-like genes (At4g26120 and At5g45110). These two genes are most similar to the NPR1 present in Arabidopsis genome; therefore it would not be surprising to find that they also regulate some aspects of plant defense system against pathogens. Interestingly, At5g45110 is predicted to be localized in the chloroplast (TAIR data base (Rhee *et al.*, 2003)), however, no experimental evidence is available to support this prediction.

2.4 Transcription factors and *cis*-elements responsive to SA in defense genes

2.4.1 TGA factors and TGA boxes

TGA factors belong to the family of bZip plant transcription factors and bind to *cis*-elements containing TGA box, characterized by the consensus palindromic core TGACGTCA motif and present in several plant promoters activated by SA, stress conditions and pathogens (Krawczyk *et al.*, 2002; Eulgem, 2005). Further in this section we will discuss the differences between TGA box elements found in different gene classes activated by SA. Table 1 summarizes all the information about TGA factors that will be discussed in this section.

The Arabidopsis genome encodes for 10 genes classified as TGA factors, seven of them have been directly implicated in defense against pathogens, and one in flower development (Jakoby *et al.*, 2002). All seven known TGA factors involved in the defense response can be grouped in three subclasses, according to their sequence identity: I. TGA1 and TGA4, II. TGA2, TGA5 and TGA6, and III. TGA3 and TGA7 (Xiang *et al.*, 1997). TGA factors have also been characterized in species like rice (Fitzgerald *et al.*, 2005) and tobacco (Katagiri *et al.*, 1989; Niggeweg *et al.*, 2000a; Schiermeyer *et al.*, 2003).

TGA factors exist as dimers (Katagiri *et al.*, 1992) and each protein consists of three defined domains: the N-terminal domain involved in the transactivation activity (Pascuzzi *et al.*, 1998), the bZip domain responsible for DNA binding and dimerization (Katagiri *et al.*, 1992), and the C-terminal domain that is required for the interaction with NPR1 (Zhang *et al.*, 1999).

It has been extensively proposed that TGA factors can heterodimerize *in vivo*. However, heterodimerization of TGA transcription factors has been demonstrated *in vitro* (Niggeweg *et al.*, 2000b), in yeast two hybrid assays (Schiermeyer *et al.*, 2003), and in plants overexpressing TGA factors ectopically (Niggeweg *et al.*, 2000a); all conditions where artificial interactions might occur due to the large amount of expressed proteins. Dimers of different TGAs have not yet been found *in vivo* under physiological conditions and in addition, some available data better supports the idea of a more important role for homodimers than for heterodimers of TGA factors (Klinedinst *et al.*, 2000; Niggeweg *et al.*, 2000a; Johnson *et al.*, 2003). Even when heterodimerization *in vivo* has not been demonstrated, the redundancy of TGA factors is clear, especially for genes belonging to the same subclass of TGAs. Indeed, the *tga6* single mutant or *tga2/tga5* double mutants do not present any obvious phenotype (Zhang *et al.*, 2003).

However, when all genes representing subclass II of TGA factors were knocked out in the triple mutant *tga1,tga5/tga6*, a clear phenotype emerged: plants were compromised in SAR, they were hypersensitive to SA, and the *PR1* gene was not induced upon SA treatment, mimicking *npr1* mutant (Zhang *et al.*, 2003).

Table 1. Available information about TGA factors from Arabidopsis and Tobacco.

TGA factor	Binding to NPR1 in yeast	Binding to NPR1 in plants	DNA element recognized	Functional characterization
Arabidopsis				
TGA1	- (Despres <i>et al.</i> , 2000)	+ (Despres 2003)	<i>as-1</i> (Miao 1994)	Reduction of conserved Cys is required for binding to NPR1 (Despres <i>et al.</i> , 2000). Silencing in tomato leads to impaired SAR dependent on NPR1 (Ekengren 2003).
TGA2	+ (Zhang <i>et al.</i> , 1999)	+ (Subramaniam 2001)	<i>as-1</i> , LS5 and LS7 (Miao <i>et al.</i> , 1994), (Despres <i>et al.</i> , 2000)	No phenotype in plants overexpressing TGA2 (Kim and Delaney, 2002). Overexpression of dominant negative TGA2 (TGA2 C-terminal domain), phenocopies <i>npr1</i> mutants (Fan and Dong, 2002). Triple mutant <i>tga2 tga5 tga6</i> phenocopies <i>npr1</i> mutants (Zhang <i>et al.</i> , 2003). SA stimulates binding to PR1 promoter <i>in vivo</i> (Johnson <i>et al.</i> , 2003).
TGA3	+ (Despres <i>et al.</i> , 2000)	Highly probable (Johnson <i>et al.</i> , 2003)	<i>as-1</i> ,LS7 (Miao <i>et al.</i> , 1994), (Zhou <i>et al.</i> , 2000)	TGA3 protein is degraded by the proteasome (Pontier <i>et al.</i> , 2002). SA stimulates binding to PR1 promoter <i>in vivo</i> (Johnson <i>et al.</i> , 2003)
TGA4	- Despres, 2000 #92}	Probable (Despres 2003)	<i>as-1</i> (Zhang 1994)	Repress SA and H ₂ O ₂ dependent expression of genes containing <i>as-1</i> element in their promoters (Foley and Singh, 2004). Contains conserved Cys involved in redox sensing (Despres <i>et al.</i> , 2003).
TGA5	+ (Zhang <i>et al.</i> , 1999)	ND	<i>as-1</i> (Zhang 1994)	Triple mutant <i>tga2 tga5 tga6</i> phenocopies <i>npr1</i> mutants (Zhang <i>et al.</i> , 2003). Plants overexpressing TGA5 present enhanced resistance to pathogens independently of SA and NPR1 (Kim and Delaney, 2002). Enhances SA and H ₂ O ₂ dependent expression of genes containing <i>as-1</i> element in their promoters (Foley and Singh, 2004).
TGA6	+ (Zhang <i>et al.</i> , 1999)	ND	<i>as-1</i> (Xiang <i>et al.</i> , 1997)	Triple mutant <i>tga2 tga5 tga6</i> phenocopies <i>npr1</i> mutants (Zhang <i>et al.</i> , 2003). Single <i>tga6</i> mutant has no phenotype.
TGA7	+ (Hepworth <i>et al.</i> , 2005)	ND	ND	
Tobacco				
PG13	ND	ND	<i>as-1</i> (Niggeweg <i>et al.</i> , 2000b)	
TGA1a	- (Niggeweg <i>et al.</i> , 2000b)	ND	<i>as-1</i> (Katagiri <i>et al.</i> , 1989)	SA and xenobiotics stimulate binding to GST promoter (<i>as-1</i> like element), but not PR1 promoter (TGA box element) (Johnson <i>et al.</i> , 2001).
TGA2.1	+ (Niggeweg <i>et al.</i> , 2000b)	ND	<i>as-1</i> (Niggeweg <i>et al.</i> , 2000b)	RNAi plants: altered flower phenotype. No role in SA-dependent gene expression (Thurrow <i>et al.</i> , 2005). Overexpressing plants: Enhanced expression of genes early induced by SA and 2,4D in leaves but not in roots (Schiermeyer <i>et al.</i> , 2003). Dominant negative plants: No effect on SA-dependent PR1 expression, but reduced expression of early induced genes (Kegler <i>et al.</i> , 2004).
TGA2.2	+ (Niggeweg <i>et al.</i> , 2000b)	ND	<i>as-1</i> (Niggeweg <i>et al.</i> , 2000b)	RNAi plants: Strongly reduced expression of genes early and late induced by SA (Thurrow <i>et al.</i> , 2005). Overexpressing plants: No altered visual phenotype. Upon SA and 2,4D treatments, increase expression of early but not late genes (Niggeweg <i>et al.</i> , 2000a). Dominant negative plants: reduced induction by SA of early and late genes (Niggeweg <i>et al.</i> , 2000a). Main component of nuclear complex that binds <i>as-1</i> like promoters <i>in vivo</i> (Niggeweg <i>et al.</i> , 2000a).

An important feature of TGA factors is their capability to interact with NPR1. Several two hybrid screenings have been described where NPR1 was used as the bait from which TGA factors were isolated. Analyses of these interactions have concluded that in yeast, NPR1 interacts with TGA2, TGA3, TGA5, TGA6 and TGA7 (Table 1) (Zhang *et al.*, 1999; Despres *et al.*, 2000; Zhou *et al.*, 2000). More careful studies in plants demonstrated that NPR1 also interacts with TGA1 (and probably also with TGA4) but TGA1 needs to be reduced for the binding to occur (Despres *et al.*, 2003). This reduction of TGA1 can be triggered by SA or its analogs (Despres *et al.*, 2003). TGA1 and TGA4 have two conserved Cys residues, absent in the rest of the TGA factors, that are modified by the redox conditions of the cell, and modulate their ability to recognize other proteins in response to the oxidative environment (Despres *et al.*, 2003). In the same direction, it was demonstrated that the SA-dependent binding of nuclear proteins to *as-1* sequence (presumable TGA factors), can be strongly modulated by chemicals that modify the redox condition of the plant. In particular, antioxidants were able to inhibit the stimulatory effect of SA (Garretón *et al.*, 2002). All this evidence highlights the fact that the redox balance of the cell plays a key role in SA transduction pathway and pathogen defense response (Fobert and Despres, 2005).

Several genetic characterizations have been carried out with genes encoding for TGA factors mainly in Arabidopsis and tobacco. Because of the extent of the family of TGA factors, most studies have been performed by overexpressing dominant negative forms of TGA factors with the idea of inhibiting the activity of several of them at the same time. Unfortunately, the results are not easy to interpret (Niggeweg *et al.*, 2000b; Pontier *et al.*, 2001; Fan and Dong, 2002; Thurow *et al.*, 2005). The available information is summarized in table 1. Despite what has been said earlier, two strong conclusions emerge from these studies: 1. TGA factors play an important role in the expression of genes early induced by SA (1-2h) like *GSTs* and *GTs*, and also of genes induced much later by SA (6h), like *PR* genes. 2. TGA factors can act both as activators and repressors (Foley and Singh, 2004). The best example of the second conclusion was obtained by using an *as-1*-like element controlling the expression of a reporter gene and RNAi Arabidopsis lines were TGA4 and TGA5 expression was abolished (Foley and Singh, 2004). In this report it was demonstrated that TGA4 acts as a repressor and TGA5 as an activator on the same *cis* element (Foley and Singh, 2004).

It is important to keep in mind that the phenotypes seen with TGA the dominant negative approach can be due not only to the lack of DNA binding activity of TGA factors, but also to the sequestration of other proteins that normally interact with TGA factors, like NPR1. Consistently with this idea,

Fan and Dong (2002) showed that overexpression of only the C terminal domain of TGA2 behaves as a dominant negative. Even when this domain does not bind DNA and probably neither other TGA factors, it does retain its NPR1 binding capability (this C-terminal domain is present in all dominant negative overexpression experiments performed). Moreover, these transgenic plants developed all known *npr1* phenotypes: impaired SAR, no SA-dependent *PR1* expression, and hypersensitivity to exogenous SA (Fan and Dong, 2002).

Experiments overexpressing several TGA factors have also been carried out (Table 1). Overexpression of TGA2 does not modify SA dependent *PR1* expression or SAR, but plants that apparently overexpress TGA5 (the authors did not prove overexpression of the TGA5 protein) are more resistant to a strongly virulent strain of *P. parasitica*, but independently of NPR1 and SA (Kim and Delaney, 2002). Overexpression of TGA factors in tobacco also demonstrates the relevance of these proteins for the SA-dependent regulation of gene expression during SAR and defense against other stresses (Thurow *et al.*, 2005).

As mentioned earlier, the binding sites for TGA factors contain TGA box, characterized by the consensus palindromic core TGACGTCA motif (Krawczyk *et al.*, 2002). TGA boxes were first described in 35S proximal promoter of the Cauliflower Mosaic Virus CaMV 35S (-81 to -62) (Lam *et al.*, 1989). In this promoter, a 20-bp sequence named activation sequence 1 (*as-1*) was defined as the binding site for cellular factors from tobacco and pea, and contains two tandem repeats of TGA boxes separated by 4 nucleotides (Lam *et al.*, 1989). Then, related *as-1*-like elements (also named *ocs*-like) were described in the promoter of other viral and Agrobacterium promoters (reviewed by Krawczyk *et al.*, 2002). Functional analyses of *as-1*-like sequences indicate that this element confers immediate early response to SA (Qin *et al.*, 1994). Therefore, and consistently with their activity as SA-responsive elements, *as-1*-like elements (with the conserved distance of 4 nucleotides between the two TGA boxes) are present in the promoter of plant stress defense genes such as *GSTs*, and confer early induction by SA (i.e. tobacco *GNT35* and Arabidopsis *GST6*) (Xiang *et al.*, 1996; Chen and Singh, 1999). Recently, a consensus *as-1*-like element was defined and found over-represented in the promoter of a group of genes involved in cell protection that are early activated by SA via an NPR1-independent pathway (Blanco *et al.*, 2005). It has been clearly established that *as-1*-like elements, found in plant, viral and bacterial promoters, and in early SA-activated promoters, are not only able to respond to SA, but also to xenobiotics, high concentrations of auxins and other stress-related chemicals (Liu and Lam, 1994; Qin *et al.*, 1994; Ulmasov *et al.*, 1994; Xiang *et al.*, 1996; Garretton *et al.*, 2002). Experimental evidence indicating that *as-1* acts as an oxidative

stress-responsive element and that its activation by SA is mediated by oxidative species, supports the hypothesis that stress-related signals activate *as-1*-like elements through a common oxidative signal (Garretón *et al.*, 2002). It has been proved that *as-1*-like elements are recognized by TGA factors *in vivo* (Niggeweg *et al.*, 2000a; Johnson *et al.*, 2001; Pontier *et al.*, 2001).

On the other hand, TGA boxes were also found in the promoter of late SA-responsive genes such as *PR-1* from tobacco and Arabidopsis, and these TGA boxes were also defined as SA-responsive elements (Lebel *et al.*, 1998; Strompen *et al.*, 1998). The presence of two tandemly repeated TGA boxes in these *PR-1* promoters lead to confusingly naming these elements “*as-1*-like”. However, important structural and functional differences exist between TGA boxes in *PR-1* genes and *as-1*-like elements found in early induced and stress-activated genes like *GSTs*. First, spacing between TGA boxes in *PR-1* promoters are longer and less conserved than those found in *as-1*-like elements (Krawczyk *et al.*, 2002). Second, contrary to *as-1* like elements, the two tandemly repeated TGA boxes present in *PR1* promoters can be functionally separated between them. Indeed, detailed analysis of the Arabidopsis *PR-1* promoter showed that one TGA box (named *LS5*) is involved in basal repression of the gene, and the other (*LS7*), placed 9 bp downstream of *LS5*, is required for SA-mediated activation (Lebel *et al.*, 1998). *LS5* and *LS7* TGA boxes can independently bind to TGA factors *in vitro*, supporting the idea of independence between them (Despres *et al.*, 2000). In contrast, both TGA boxes of *as-1* element are required in concert for its activity (Benfey *et al.*, 1990; Neuhaus *et al.*, 1994). Finally, while genes containing *as-1*-like elements can be induced by different stress conditions and they are activated after 30-120 min of SA treatment; *PR-1* genes are only late induced by SA and only after 4h treatment (Uquillas *et al.*, 2004). Interestingly, NPR1 is required for the *in vivo* interaction of TGA factors with *PR-1* promoter (Johnson *et al.*, 2003).

In addition, other strategies have also been developed to understand the role of TGA factors and their selectivity for TGA boxes *in vivo*. It has been shown that TGA1a from tobacco can specifically bind *in vitro* to TGA box elements present in *PR1*, and to *as-1*-like elements present in *GSTs* (Johnson *et al.*, 2001). However, subsequent experiments using chromatin immunoprecipitation assays demonstrated that *in vivo* TGA1a only binds to *as-1*-like promoters present in *GSTs* and not to TGA boxes present in *PR1* and *PG13* genes (Johnson *et al.*, 2001). Even more, the authors showed that the *in vivo* TGA1a binding to *as-1*-like was strongly stimulated by the treatment with a xenobiotic compound that produces oxidative stress (Jirage *et al.*, 2001; Johnson *et al.*, 2001). Additional experiments using the same kind of assays demonstrated that Arabidopsis TGA2 and TGA3 bind to *LS7*,

the activator TGA box present in the *PR1* promoter, and that these two TGA factors are responsible for almost the entire *LS7* binding activity present in leaves (Johnson *et al.*, 2003). Finally, it was shown that the binding of TGA2 and TGA3 to the TGA boxes of *PR1* promoter is highly induced by SA and depends on NPR1 (Johnson *et al.*, 2003). Therefore, TGA factors selectively bind *in vivo* to some *as-1*-like or TGA box elements.

In summary, information is consistent with the idea that SA can use parallel mechanisms to activate different groups of genes. Different TGA box-containing promoter elements, and the differential use of NPR1, can explain differences in the kinetics of activation observed in genes regulated by SA. Future work to elucidate whether different TGA boxes are *in vivo* targets for different subclasses of TGA factors would provide important information to assemble this puzzle.

2.4.2 Other transcription factors and cis elements responsive to SA

Other transcription factors, besides TGAs, that participate in the activation of defense genes by SA have also been identified (Eulgem, 2005). We will briefly describe two main families, WRKY and WHIRLY, for which stronger evidence of their involvement in SA pathway has been obtained (Figure 4; Eulgem *et al.*, 2000; Desveaux *et al.*, 2005). It has to be mentioned here that other families of transcription factors like ERF and MYB factors have also been implicated in SA pathway (Eulgem, 2005).

WRKY transcription factors are only found in plants and they bind to W box (TGACC/T), an element highly similar to TGA boxes (Eulgem *et al.*, 2000). The Arabidopsis genome encodes at least 75 *WRKY* genes and most, if not all, bind to W box (Eulgem, 2005). Several genes coding for WRKY factors are early induced by SA and pathogens, and some of them do not require NPR1 for their induction (Dong *et al.*, 2003). Effects on disease resistance observed in silenced and overexpressing lines suggest that WRKYs are required for efficient pathogen defense (Chen and Chen, 2002); (Asai *et al.*, 2002; Li and al, 2004). More importantly, only 17 out of 26 genes belonging to PR1 regulon have a TGA box in their promoters, whereas W-boxes are overrepresented, occurring an average of 4.3 times in every promoter (including the *PR1* promoter) (Maleck *et al.*, 2000). Interestingly, WRKY factors are activated by MAPK and ROS (Andreasson *et al.*, 2005).

WHIRLY transcription factors were named after the whirligig appearance of their crystal structure (Desveaux *et al.*, 2002). Whirly factors were first isolated from potato tubers and the first member was named PBF-2 (Desveaux *et al.*, 2000). A very distinct feature about Whirly factors is that they specifically bind the single stranded form of a defined element present

in the *PR10a* promoter (PB element) (Desveaux *et al.*, 2000). *PR10a* is strongly induced in potato by the pathogenic *Phytophthora infestans* (Desveaux *et al.*, 2000). Arabidopsis encodes three Whirly factors of which Atwhirly 1 is the most similar to potato Whirly (Desveaux *et al.*, 2005). SA treatment induces binding of Whirly factors to PB element (GTCAAAAA/T) and this induction is independent of NPR1 (Delaney *et al.*, 1995). Interestingly, the PB element is overrepresented in genes co-regulated during SAR (Desveaux *et al.*, 2004). Weak mutants of Atwhirly1 show reduced binding activity to their DNA element, and they are strongly compromised in their basal resistance to pathogens and in the SAR response (homocigote *Atwhirly-1* mutants are lethal) (Desveaux *et al.*, 2004). Interestingly, potato Whirly, which is predicted to contain a plastid transit peptide, has been shown to localize to both the chloroplast and the nucleus (Desveaux *et al.*, 2005).

In summary, genes induced by SA can be controlled by several *cis* elements interacting with different families of transcription factors (Eulgem, 2005). In the future, a combination of functional analysis of defined promoters, with *in silico* analysis of common elements found in genes co-activated by SA, will be required to have a better idea of the mechanism by which SA activates genes. In this context, studies done by several groups (Maleck *et al.*, 2000; Blanco *et al.*, 2005; Wang *et al.*, 2005), and the careful analysis done on the Arabidopsis *PR1* promoter, that allowed to identify at least one negative regulator W-box and two TGA boxes (one negative and one positive regulator) (Lebel *et al.*, 1998), are good examples.

2.5 Other proteins interacting with NPR1

Besides TGA factors, NPR1 also interacts with several other proteins. An interesting feature of these new proteins is that all of them are negative regulators of SA-induced *PR1* and SAR.

One of these new components is a family of small proteins called NIMIN (NPR1/NIM-1 interacting protein). All three known *NIMIN* genes are induced in plants by SA, they localize mainly to the nucleus and at least in yeast, they form a ternary complex with TGA-2 and TGA-6 factors via NPR1 (Weigel *et al.*, 2001). Functional studies in Arabidopsis plants overexpressing NIMIN-1, showed that it acts as a negative regulator of SA-induced *PR1* expression and SAR (Weigel *et al.*, 2005). However, contrary to plants overexpressing NPR1, a *nimin-1* T-DNA insertional mutant and RNAi lines, do not show enhanced resistance to pathogens, suggesting that other NIMIN proteins have some overlapping functions with NIMIN-1, or that binding of NIMIN-1 to NPR1 regulates only a subset of NPR1 activities (Weigel *et al.*, 2005).

A less well characterized NPR1-interacting protein is Suppressor of NPR1-1 Inducible 1 (SNI1). *SNI1* was isolated in a screen to find suppressors of *npr1*. SNI1 is a nuclear protein that acts together with or downstream NPR1 and encodes a leucine-rich protein with no other recognizable homology (Li *et al.*, 1999). *sni1* and *sni1/npr1* mutants do not present constitutive SAR and show near wild type levels of *PR1* expression and pathogen defense (Li *et al.*, 1999). Even when this gene was first described in 1999, we still do not know more about its mechanism of action.

Negative Regulator of Resistance protein (NRR) is another protein that also interacts with the homolog of NPR1 in rice (NH1), and constitutes another negative regulator of pathogen defense in plants (Chern *et al.*, 2005). NRR is a nuclear protein that presents very limited homology (only around 20 residues in the N-terminal domain) with NIMIN-2 from Arabidopsis and G8-1 from tobacco. NIMIN-2, as already mentioned, belongs to a family of negative regulators that bind NPR1, and G8-1 was isolated as an immediate early gene induced by SA (Horvath *et al.*, 1998; Weigel *et al.*, 2001). Silencing of NRR in rice has little effect on resistance to pathogen *Xanthomona oryzae* but overexpression of NRR caused enhanced susceptibility to this pathogen, and suppressed the induction of defense-related genes (Chern *et al.*, 2005).

Interestingly, within the collection of proteins interacting with NPR1, a significant number out of them function as negative regulators. This is true for all proteins that are not TGA factors and even for some TGA factors as well. Until now the role of NPR1 in the activation of SAR and defense has been the main focus in this area of study (Dong, 2004; Durrant and Dong, 2004; Pieterse and Van Loon, 2004). However, it is easy to predict that the role of negative regulators will emerge as a very important step in the regulation of this pathway in the future.

A summary of all the components of SA pathway mentioned here are presented in Figure 4. Some components, like CK2 or MAPK do not have a clear position in the pathway yet.

3. IDENTIFICATION OF STRESS DEFENSE GENES

Successful defense response involves a multitude of physiological reactions such as PCD, modification of cell wall, production of antimicrobial proteins and metabolites and cell protection against stress. Together with these processes, the expression of a large number of genes is induced (reviewed by Glazebrook, 2005).

Our knowledge about defense-associated gene expression is currently being extended substantially by large-scale gene expression profiling

technologies. Microarray analyses in *Arabidopsis thaliana* plants treated with a variety of different pathogens, messenger molecules such as SA and elicitors, have revealed that in addition to the classical *PR* genes, several other genes exhibit differential expression after the activation of defense program. To obtain a better knowledge about the kind of biological functions that are regulated during stress responses, we have analyzed transcriptome data sets of seven different experiments related to the SA-dependent defense response; (Maleck *et al.*, 2000; Glazebrook *et al.*, 2003; Fobert and Despres, 2005; Vanderauwera *et al.*, 2005; Wang *et al.*, 2005; Blanco, Van Hummelen and Holuigue, unpublished results).

3.1 Description of the microarray dataset

We analyzed the available transcriptome data sets of biotically and abiotically stressed *Arabidopsis* plants, which encompasses a wide range of experimental conditions. These conditions include plants subjected to oxidative stress (H₂O₂) (Vanderauwera *et al.*, 2005), inoculation with avirulent *Pseudomonas syringae* pv *tomato* DC3000 avrRpt2 and the virulent *Pseudomonas syringae* pv *maculicola* ES 4326 pathogens (Glazebrook *et al.*, 2003; Wang *et al.*, 2005), and treatment with SA (or its analog BTH) for different periods of time (Maleck *et al.*, 2000) (Blanco, Van Hummelen and Holuigue, unpublished results). The platforms technologies used were ATH1 Affymetrix (22K (Vanderauwera *et al.*, 2005)), Affymetrix GeneChip (~8K, (Wang *et al.*, 2005), (Glazebrook *et al.*, 2003)), cDNA microarrays (~7K, (Maleck *et al.*, 2000)) and CATMA array (23K, (Blanco, Van Hummelen and Holuigue, unpublished results)) Recently, Pylatuik *et al.*, demonstrated that all platform technologies (*Arabidopsis thaliana* microarrays) appear to perform equally well respect to the induced genes, even though the concordance between platforms is limited primarily by the rate of false negative results (Pylatuik and Fobert, 2005).

For this analysis we selected genes significantly induced in each experiment (Table 2). Then, the genes were classified by their function using gene ontology (<http://www.arabidopsis.org>) and we concentrated our analysis on the genes with known or putative function related to defense or cell protection against stress. This genome-wide expression analysis allowed us to classify the up-regulated genes into functional groups. Table 2 shows the classification of functions we have considered, the number of genes for each class that are induced in each experiment, and the percentage that these genes represent within the total number of induced genes. Finally, we briefly describe the most important proteins belonging to each group.

3.2 Detoxifying and antioxidant genes

As previously mentioned, ROS can play two different roles in plant cells: exacerbating oxidative damage or signaling the activation of defense pathways. Because of this, plants cells are equipped with a complex battery of systems involved in ROS detoxification and signaling, as described in section 1.2. Furthermore, plants are also equipped with a family of proteins involved in detoxification of ROS and metabolites. Therefore, we considered in this class of “detoxifying and antioxidant genes” all genes coding for proteins that may play this kind of roles in the defense response.

Table 2. Number of stress defense genes up-regulated in selected experiments

Reference	Treatment	Detoxifying and antioxidant genes ^a	Synthesis of secondary metabolites	Defense genes (R, TF, PR proteins)	% of stress defense genes (total # genes induced) ^b
Maleck	BTH 4h	5	-	5	25% (40)
Blanco	SA 2,5h	17	7	19	18,6% (231)
Maleck	BTH 48h	6	4	9	26,7% (71)
Glazebrook ^c	Pst 4623, 30 hpi	16	20	13	50% (98)
Maleck	Pst avrRpt2, 44 hpi	6	2	10	35% (51)
Vanderauwara ^d	CAT2H1/HL	15	16	18	25,9% (189)
Wang ^e	35S::NPR1-GR (SA-Chx/Dex)	10	8	24	37,9% (114)

^aThis group includes GST, GT CytP450, PRX, PX, TRX and GRX. ^b Percentage of stress defense genes over the total of induced genes. The total number of induced genes in each experiment is shown within parenthesis. ^c For this analysis we considered up-regulated genes with a cutoff value ≥ 18 . ^d Genes induced in catalase-deficient Arabidopsis plants subjected to high light (HL) treatment, representing up-regulated genes by increased H₂O₂ accumulation; HL. ^e 35S::NPR1-GR transgenic lines treated first with SA (24h) and then with cicloheximide/dexamethasone (Chx/Dex), representing genes which are up-regulated by SA and NPR1 dependent. GST: Glutathion *S*-transferase; GT: Glycosyl transferase; PRX: Peroxiredoxin; PX: Peroxidase; TRX: Thioredoxin; GRX: Glutaredoxin; R: resistance genes, TF: transcription factors and PR: pathogenesis related proteins (Glazebrook *et al.*, 2003; Maleck *et al.*, 2000; Vanderauwera *et al.*, 2005; Wang *et al.*, 2005; Blanco, Van Hummelen and Holuigue, unpublished results).

Not surprisingly, several genes involved in these functions were consistently induced in the experiments we analyzed. For example we found enzymes with transferase activity involved in detoxification, like GST and GT, and several proteins involved in redox modification considered to be

part of the antioxidant and/or redox signaling systems, like thioredoxins (TRX), glutaredoxins (GRX), peroxidases (POX), peroxiredoxins (PRX) and cytochrome P450. In the following sections we will describe the most relevant features about these genes and their known or putative function in stress defense.

3.2.1 Cytochrome P450 (CytP450)

CytP450 monooxygenases are a group of heme-containing proteins that catalyze various oxidative reactions. In higher plants, cyt P450 are involved in the biosynthesis of various compounds such as lignins, UV protectants, pigments, defense compounds, fatty acids, phytohormones and signaling molecules (Schuler and Werck-Reichhart, 2003). The Arabidopsis genome encodes for 272 cyt P450 genes (<http://arabidopsis-P450.biotech.uiuc.edu>). Analysis of several hundreds different cyt P450 substrates, allowed us to broadly separate them into two classes; those involved in biosynthetic pathways and those involved in detoxification pathways (Chapple, 1998). More recently, studies concerning the function of specific members of cyt P450 family in defense have been reported. For instance, it has been described that *CYP71A13* is up-regulated in response to wounding (Cheong *et al.*, 2002), and *CYP72A15*, *CYP76C2* and *CYP710A1* are involved in salt stress (Kreps *et al.*, 2002). In addition, *CYP75B1* was identified as a flavonoid 3'-hydroxylase gene involved in phenylpropanoid pathway (Schoenbohm, 2000) and *CYP710A1* and *CYP76C2* were reported to be early induced in response to SA treatment and pathogen infections (Narusaka *et al.*, 2004). Therefore, several cyt P450s are genetic markers associated with HR and senescence (Narusaka *et al.*, 2004). Interestingly, *in silico* analyses of the promoter sequences of the cyt P450 induced by both abiotic and biotic stresses, showed that they contain a W-box, a ACGT-core and a TGA-box. All these *cis*-elements are known to participate in the transcriptional regulation of plant defense genes (Narusaka *et al.*, 2004).

Consistently with their wide diversity of substrates, in our analysis we found 15 cyt P450s that are activated in the selected experiments.

3.2.2 Transferases

3.2.2.1 Glycosyltransferases (GTs)

GTs are the enzymes that transfer nucleotide-diphosphate-activated sugars to low-molecular-weight aglycone substrates, including plant hormones, all major classes of plant secondary metabolites, and xenobiotics such as herbicides (Keegstra and Raikhel, 2001). Glycosylation by GTs

regulates several properties of their substrates such as their bioactivity, solubility and transport within the cell and through the plant (Ross *et al.*, 2001). The Arabidopsis genome has 118 putative genes coding for GTs. Phylogenetic analysis of GT proteins allows to define 14 groups (A to N) (Li *et al.*, 2001). Interestingly, in our analysis we found 18 different GTs genes that were consistently induced during the defense response; nine belonging to group L and four to group D. Even when none of these induced GTs has been previously characterized, they belong exclusively to those families already associated with defense mechanisms. For instance, GTs that glycosylate SA and indole-3-acetic acid, two important metabolites that regulate plant defense, belong to group L (Lee and Raskin, 1999; Jackson *et al.*, 2001). In addition, UGT75B1 (belonging to group L) has been characterized as a callose synthase-associated GT, a processes that is importantly stimulated after pathogen infection (Hong, 2001). Finally, tomato and tobacco GTs belonging to group D respond rapidly to signals from wounding and pathogen attack (O'Donnell, 1998; Roberts, 1999). These data suggest that GT induction during the defense response is selectively controlled probably due to the requirement imposed by very specific compounds that are substrates of D and L families of GTs.

3.2.2.2 Glutathione S-transferases (GSTs)

GSTs are a diverse group of multifunctional proteins that catalyze the transfer of the tripeptide glutathione to a substrate with a reactive electrophilic center, thus forming a polar S-glutathionylated conjugate. This reaction is considered to be a crucial step in the detoxification process, because S-glutathionylated metabolites are tagged to the vacuolar import machinery (Sandermann, 1992; Dixon *et al.*, 2002).

In Arabidopsis, the GST superfamily has 53 members classified in 4 classes, namely Phi, Tau, Theta and Zeta (Marrs, 1996). The two largest classes are the plant-specific GSTs Phi and Tau. Phi and Tau GSTs have a major role in herbicide detoxification and in protecting plants against oxidative damage (Kilili *et al.*, 2004). Interestingly, from our analysis we identified a total of 9 GSTs all belonging to these two groups.

In addition to the roles already mentioned, GSTs in general are responsible of modifying stress signalling proteins (Loyall *et al.*, 2000) and regulators of apoptosis (Kampranis, 2000); and the expression of GSTs in plants is highly responsive to biotic and abiotic stress and to a wide variety of stress-associated chemicals, including auxins, SA, methyl jasmonate, abscisic acid and H₂O₂ (Roxas, 1997).

The preferential induction of Tau GSTs by 0.1mM SA and Phi GSTs by 1mM SA was established and is consistent with the idea that Tau GSTs are

generally hormone-responsive while Phi GSTs act as cellular protecting proteins (Sappl *et al.*, 2004).

3.2.3 Oxidoreductases

In this section we included a group of genes that encode for oxidoreductases involved both in antioxidation and redox signaling functions. Even though the number of genes belonging to these families found in our analysis is not high, their value of induction is very significant and deserves attention. We found high induction of five peroxidases (POX), two peroxiredoxins (PRX), one thioredoxin (TRX) and two glutaredoxins (GRX).

3.2.3.1 Peroxidases (POX) and peroxiredoxin (PRX)

Plants POX catalyze the oxidation of phenolic compounds using H₂O₂ as the oxidizing agent. Each plant possesses several POX isoenzymes, and each isoenzyme shows diverse expression profiles, suggesting that POXs act in various physiological processes. Indeed, studies have provided evidence that POXs participate in lignification, auxin catabolism, wounding and defense against pathogen infection (Hiraga *et al.*, 2001).

Recent studies have provided information on the regulatory mechanisms of wound- and pathogen-induced expression of POX genes. These studies suggest that POX genes are induced via different signal transduction pathways out of the other known defense-related genes (Hiraga *et al.*, 2001).

Extracellularly secreted POXs are considered to catalyze the generation of ROS coupled to the oxidation of indole-3-acetic acid (a plant hormone), SA, aromatic monoamines and chitoooligosaccharides (Kawano *et al.*, 2000). It has also been suggested that POXs transduce extracellular signals into the cell, altering the redox status that eventually stimulate the intracellular Ca⁽²⁺⁾ signaling required for the induction of defense responses (Kawano, 2003). Moreover, it has been demonstrated that APX1, one of Arabidopsis POX, is a central component of the ROS scavenging network (Davletova *et al.*, 2005).

Peroxiredoxins (PRXs) are ubiquitous thioredoxin- or glutaredoxin-dependent peroxidases, the function of which is to destroy peroxides. PRXs are located in distinct cell compartments including the chloroplast and mitochondria. PRXs show a complex regulation by endogenous and environmental stimuli at both, transcript and protein levels (Dietz, 2003)). In addition to their role in antioxidant defense associated to photosynthesis, respiration, and stress response, they have been proposed to be involved in the modulation of the redox balance during development (Broin *et al.*, 2002). Recently, it has been demonstrated that the mitochondrial Type II PRX F is

essential for redox homeostasis and root growth in *Arabidopsis* under stress (Finkemeier *et al.*, 2005). This Type II PRX F was previously described to be induced during HR, but repressed by a virulent infection (Rouhier *et al.*, 2004).

Unlike Type II peroxiredoxins, peroxiredoxin Q cannot use glutaredoxin or cyclophilin as electron donors, but it efficiently uses various cytosolic, chloroplastic, and mitochondrial thioredoxins.

3.2.3.2 Protein disulfide oxidoreductases (Glutaredoxins (GRX) and Thioredoxins (TRX))

Initially discovered in the context of photosynthesis, regulation of protein activity by changes in the redox status of thiol groups ($S-S \leftrightarrow 2SH$) is now known to occur extensively in all organisms. Most cells contain high levels of glutathione and multiple GRXs (31 GRX in *Arabidopsis* genome), which utilize the reducing power of glutathione to catalyze disulfide reductions in the presence of NADPH and glutathione reductase (the GRX system) (Buchanan and Balmer, 2005).

The TRXs are small proteins, reduced enzymatically by NADPH or ferredoxin that is active in thiol-disulfide exchange and results in the regulation or substrates conversion. There are 20 different genes grouped in 6 sub families of TRX, Trx f, h, m, x, y and o. Trx f, m, x and y are localized in the chloroplast. (Buchanan and Balmer, 2005)

Certain GRXs and TRXs play direct roles in the antioxidative system by regenerating peroxiredoxins oxidized by peroxides (Rouhier *et al.*, 2001). It has also been postulated that two proteins from the glycine cleavage complex are putative TRX substrate suggesting a main role for TRX in the defense against herbivores and pathogens (Marchand, 2004).

More importantly, GRXs and TRXs have been proposed to be implicated in the redox signaling of processes mediated by SA in the defense response. One case is the modulation of the activity of key antioxidant enzymes (APX and CAT) (Yamazaki *et al.*, 2004), which is crucial in light- and pathogen-triggered PCD responses (Mateo *et al.*, 2004). The other example, in which the participation of GRXs and/or TRXs has been postulated, is the SA-dependent reduction of NPR1 required for the transcription of defense genes (Fobert and Despres, 2005; Foyer and Noctor, 2005). In this context, results from our analysis indicate that SA is able to rapidly activate some genes encoding for these enzymes that gives support to this hypothesis.

3.2.4 Defense proteins

In this group we classified all those genes that encode proteins clearly involved in defense. This group includes R genes, involved in pathogen

recognition, transcription factors known to be implicated in the expression of defense genes, and known defense genes such as those coding for PR proteins. We also included a recently described group of secretory pathway proteins involved in defense protein folding (Wang *et al.*, 2005). In the following section we will provide a brief description of the function of each group and the conditions under which they are expressed.

3.2.4.1 *R genes*

In our analysis, we found up-regulation of nine putative disease resistant genes (*R genes*), especially after short SA or BTH treatments. The Arabidopsis genome encodes for about 150 *R genes*. *R genes* are responsible for the early and specific recognition of pathogens and for the initiation of signal transduction leading to the development of defense reaction (Dangl and Jones, 2001).

The largest class of known *R gene* contains characteristic nucleotide binding sites (NBS) plus a leucine-rich repeat (LRR). Their most striking structural feature is a variable number of carboxy-terminal LRRs. LRR domains are present in different proteins and function as a site for protein-protein interaction, peptide-ligand binding and protein carbohydrate interaction. The NB-LRR class can be subdivided in two subclasses: TIR-NB-LRR, representing 60% of NB-LRR, and CC-NB-LRR representing the remaining 40% (Dangl and Jones, 2001).

Genetic evidence suggests that there are at least two separable R-dependent signaling pathways. One requires EDS1 and PAD4 (section 2) and the other requires NDR1, a protein of unknown biochemical function. The EDS1/PAD4 signaling pathway is typically associated with TIR-NB-LRR proteins, while the NDR1 pathway is typically associated with CC-NB-LRR proteins. There are, however, exceptions to this generalization (Glazebrook, 2001).

Interestingly, according to their sequence, in our analysis we found some *R genes* belonging to both subclasses of NB-LRR. However, most of the *R genes* consistently induced during the defense response are not related to the NB-LRR class. Unfortunately, not much is known about this other class of *R genes*.

3.2.4.2 *Transcription factors*

As already presented in section 2, several transcription factors such as TGA, WRKY, ERF, Whirly and MYB are involved in defense response (Eulgem, 2005). However, if we examine the information available in the experiments we have been analyzing, only *WRKY* and *MYB* genes were found to be up-regulated after pathogen attack or stress inducing conditions.

Both types of factors are encoded by a family of genes in *Arabidopsis thaliana*, where there are 75 *WRKY* and ~150 *MYB* transcription factors.

Based on the number of *WRKY* domains and the pattern of the zinc-finger motif, *WRKY* transcription factors have been classified into three groups. Members of Group 1 typically contain two *WRKY* domains, while most members with one *WRKY* domain belong to Group 2. Group 3 also has a single *WRKY* domain, but they have a unique pattern in their zinc-finger motif (Dong *et al.*, 2003).

Most of *Arabidopsis WRKY* genes increase their transcript level after pathogen infections or treatment with defense elicitors (Chen and Chen, 2002; Dong *et al.*, 2003). For example, transcriptional induction of *WRKYs* belonging to group III was shown upon pathogen infections and SA treatments (Kalde *et al.*, 2003). In fact, in our analysis we found nine *WRKYs* up-regulated after 2 hrs of SA treatment, five of them belong to group III and four to group II (Blanco, Van Hummelen and Holuigue, unpublished results; Pylatuik and Fobert, 2005). On the other hand, we found three *WRKY* genes up-regulated upon longer SA treatments and pathogen infection. Therefore, in contrast to the other gene families discussed until now, we do not find specificity in the induction of certain classes of *WRKY* factors during different defense responses. This supports the idea that *WRKYs* are exclusively involved in defense response to stress.

MYB transcription factors represent a family of proteins that includes the conserved *MYB* DNA binding domain. The *Arabidopsis* genome possesses 190 putative *MYB* members that can be classified into three subfamilies depending on the number of adjacent repeats in their *MYB* domain (one, two or three) (Stracke *et al.*, 2001). The *MYB* protein with a single repeat is fairly divergent and include a factor that binds to the consensus sequence of plant telomeric DNA (Yu *et al.*, 2000).

MYB factors containing two repeats (R2R3-*MYB*) constitute the largest *MYB* family in plants (about 125 genes in *Arabidopsis*), but for most of them no functional data is available. The information currently available shows that these factors participate in the defense response to environmental signals, and in hormone signaling. In particular, R2R3*MYB* 75, 90 and 12 regulate PAL metabolism in *Arabidopsis* (Hartmann *et al.*, 2005; Mehrtens *et al.*, 2005; Tohge *et al.*, 2005). In addition, *MYB4* also participates in this pathway, but it acts as a negative regulator. Indeed, expression of *MYB4* gene is down-regulated in plants exposed to UV-B light and the *myb4* mutant exhibited increased resistant to UV light (Jin *et al.*, 2000). *MYB30* expression, another R2R3*MYB*, correlates with cell death during the HR upon pathogen attack or elicitor treatment (Daniel *et al.*, 1999). Elicitor-responsive R2R3 type *MYB* genes have also been described in tobacco

(Sugimoto *et al.*, 2000) and the *MYB78* related gene in *O. sativa* that has been shown to be induced in response to fungal attack (Lee *et al.*, 2001b).

In our analysis we found six MYB factors induced under different conditions, all of them are classified into R2R3 class of MYB factors, four genes are induced after 2h of SA treatment (Blanco, Van Hummelen and Holuigue, unpublished results; Pylatuik and Fobert, 2005) and two are induced after pathogen infection and 24h of SA treatment (Glazebrook *et al.*, 2003; Wang *et al.*, 2005)

Many things remain to be done before we can have some understanding of how these large families of transcription factors mediate the plant defense response to biotic and abiotic stress and how relevant are they for these pathways.

3.2.4.3 Pathogenesis-related protein (PR genes)

Pathogenesis-related proteins (PR proteins) were described for the first time in 1970 by Van Loon, who observed the accumulation of several novel proteins after TMV virus infection of tobacco plants (Van Loon, 1970). PR proteins accumulate both in local and systemic tissues after pathogen recognition or after stress conditions that also lead to an increase in SA levels (Gaffney *et al.*, 1993; Chamnongpol *et al.*, 1998; Klessig *et al.*, 2000; Mackerness *et al.*, 2001; Pasqualini *et al.*, 2002).

Most of PRs can be grouped into one of the 14 PR families, according to their known or putative activities (Table 3; Van Lonn and Van Strien, 1999; Hoffmann-Sommergruber, 2002). However, the only PR family for which no function is assigned is PR1 protein family. Specific members of the tobacco and tomato PR1 families have antifungal activity against *oomycete* fungi, but their mechanism of action remains to be elucidated. In any case, PR1 is the most common of all SAR genetic markers (Van Lonn and Van Strien, 1999).

The expression of *PR* genes can be detected around 5-6 h after SA treatment and 12 h after pathogen infection, so these genes have been classified as “late genes”. As expected, we found an increase in the expression of *PR* genes (*PR1*, *PR2*, *PR4* and *PR5*) in experiments on plants challenged with moderately virulent pathogens, avirulent pathogen and treated for 48h with BTH (Glazebrook *et al.*, 2003; Maleck *et al.*, 2000; Wang *et al.*, 2005) but not in plants treated for short periods of time with SA or BTH (Blanco, Van Hummelen and Holuigue, unpublished results; Maleck *et al.*, 2000). These results are a crucial demonstration that the experiments analyzed really correspond to plants mounting a defense response.

Table 3. The families of pathogen related (PR) proteins

Family	Function
PR1	Unknown
PR2	β - 1,3- glucanases
PR3	Chitinases type I, II,IV, V, VI, VII
PR4	Chitinase type I, II
PR5	Thaumatococcus-like
PR6	Proteinase-inhibitor
PR7	Endoproteinase
PR8	Chitinase type III
PR9	Peroxidase
PR10	Ribonuclease-like
PR11	Chitinase type I
PR12	Defensin
PR13	Thionin
PR14	Lipid-transfer protein

Reviewed in Van Lonn *et al.*, 1999

3.2.4.4 Proteins of the secretory pathway

Recently, Wang *et al.* (2005) described another group of genes induced by SA that are involved in the secretory pathway and most of them are located in the endoplasmic reticulum. The authors of this work provide genetic evidence that this transcriptional up-regulation is essential for SAR, identifying and analyzing knockout mutants in several of these genes. These mutants show a reduction in their ability to efficiently secrete PR1 to the apoplast, reduction that correlates directly with impaired resistance against the bacterial pathogen *Pseudomonas syringae* pv *maculicola* ES4326.

3.2.5 Synthesis of secondary metabolites

Plants also respond to pathogen attack by stimulating the production of antimicrobial metabolites, and physically reinforcing the cell wall through the production of callose and lignin (Zhao *et al.*, 2005). We found several genes encoding proteins that function in this kind of processes in our analysis.

Flavonoids are important secondary metabolites derived from malonyl Co-A and the aromatic amino acid Phe. Individual plant species can synthesize a variety of flavonoid compounds, which have several functions: to provide pigmentation to attract pollinators, to defend against pathogen

attacks by acting as signaling molecules, and to protect plants from UV radiation. In our analysis we found genes encoding FAD-binding domain-containing proteins, 2OG-Fe(II) oxygenases and isoflavone reductases. We also found genes involved in the synthesis of ethylene, a hormone relevant to the defense response (Xu *et al.*, 1994; Larkindale and Knight, 2002), genes involved in the synthesis of proline, which is accumulated in plants under osmotic stress (Yoshida *et al.*, 1997) and genes encoding enzymes involved in the tropane alkaloids synthesis, compounds that exhibit a wide range of pharmaceutical activities (Lee *et al.*, 2001a).

Recent studies have implicated lipids in the activation of SAR (Durrant and Dong, 2004). Genetic screens for *Arabidopsis* mutants with altered defense responses have identified mutations in several genes putatively involved in lipid metabolism (Shah, 2005). In the data set analyzed we found esterase/lipase/thioesterase family of proteins (Glazebrook *et al.*, 2003; Vanderauwera *et al.*, 2005), lipase class 3 family of proteins (Blanco, Van Hummelen and Holuigue, unpublished results), 12-oxophytodienoate reductase 1 (OPR1) and α -dioxygenases (α DOX) (Blanco *et al.*, 2005) and lipoxygenases (LOX) (Maleck *et al.*, 2000). LOX-derived products such as hydroperoxy, hydroxy, and keto fatty acids are accumulated in plants in response to the attack by pathogens and after treatments with inducers of plant defense responses (Shah, 2005). *Arabidopsis* plants in which *αDOX1* expression is compromised developed a more rapid and severe necrotic response and exhibit increased susceptibility to an avirulent strain of *P. syringae* (de Leon *et al.*, 2002).

4. CONCLUDING REMARKS

The role that SA plays in the defense response of plants against environmental stressful conditions has been extensively studied in the 15 last years. These studies have been performed in mutants or transgenic plants that have altered the SA signaling pathway, or by evaluating the direct effect of treatment with SA or its functional analogs. The evidence obtained with these models indicate that SA, together with ROS, which accumulate in stressed cells, are essential signals to trigger either PCD (local defense response, HR) or to activate transcription of stress defense genes (systemic response, SAR) (Figure 3). Although important advances in the understanding of SAR have been made in the last years, the mechanism by which SA and ROS interplay in the activation of defense genes, is still not clear (Durrant and Dong, 2004; Fobert and Despres, 2005).

SA seems to have a strong influence on cellular redox homeostasis. On the one hand, SA has a pro-apoptotic effect during PCD by enhancing the

effect of ROS (Overmyer *et al.*, 2003); while on the other, it activates defense gene expression by triggering redox changes in components of the signal transduction pathway (Durrant and Dong, 2004; Fobert and Despres, 2005). Interestingly, as was discussed in the second section, at least two components of SA signaling pathway involved in the activation of *PR* genes, NPR1 and the transcription factors TGAs have been identified as thiol-based redox sensors (Despres *et al.*, 2003; Mou *et al.*, 2003). Also, one of the promoter elements responsive to SA in defense genes (*as-1*-like element) is responsive to oxidative signals (Garreton *et al.*, 2002).

This apparently dual effect of SA (as pro and antioxidant) could explain the biphasic (first oxidative and then reductive) effect on the cellular redox potential (GSH/GSSG), detected in plants treated with a SA analog (Mou *et al.*, 2003). This could also explain the antioxidant effect that SA plays in rice plants (Yang *et al.*, 2004) and in animal cells (Speir *et al.*, 1998).

In this context, evidences discussed in the third section indicating that some of the genes that are early activated by SA (such as oxidoreductases and transferases) have an antioxidant or redox signaling function (Uquillas *et al.*, 2004; Blanco *et al.*, 2005; Blanco, Van Hummelen and Holuigue, unpublished results), could explain some of the redox changes triggered by SA (such as thiol reduction of NPR1 and TGA factors), that are required to activate late genes like *PR-1*. Interestingly, early activation of genes with antioxidant or redox signaling functions are independent of NPR1 (Uquillas *et al.*, 2004; Blanco *et al.*, 2005; Blanco, Van Hummelen and Holuigue, unpublished results). A hypothetical model to explain the effect that SA-mediated activation of these early genes has on the activation of late genes is shown in Figure 5.

An interesting point that emerges is the role that chloroplast might play in SA pathway and the response of plants to stress. Several important components of SA pathway are located, or predicted to be in the chloroplast: SA synthesis (ICS2 enzyme) (Metraux, 2002), EDS1 (Metraux, 2002), Atwhirly-1 transcription factor, and 14 out of 23 other factors from the same family (Desveaux *et al.*, 2005), and one of the still uncharacterized NPR1-like regulators (Rhee *et al.*, 2003). Moreover, several genes regulated by SA and SAR obtained from the analysis of microarray experiments, encode for chloroplastic proteins (Blanco, Van Hummelen and Holuigue, unpublished results). It would be interesting to analyze whether in plants the defense response against pathogens and abiotic stress is modulated by light.

Several aspects are still not clear in this model. One of these aspects is the mechanism of transcriptional activation of early and late genes at the level of promoter elements and transcriptional factors involved. On this aspect, one of the main questions is how are oxidative and reductive signals controlling the interaction between TGA factors and their target cis elements

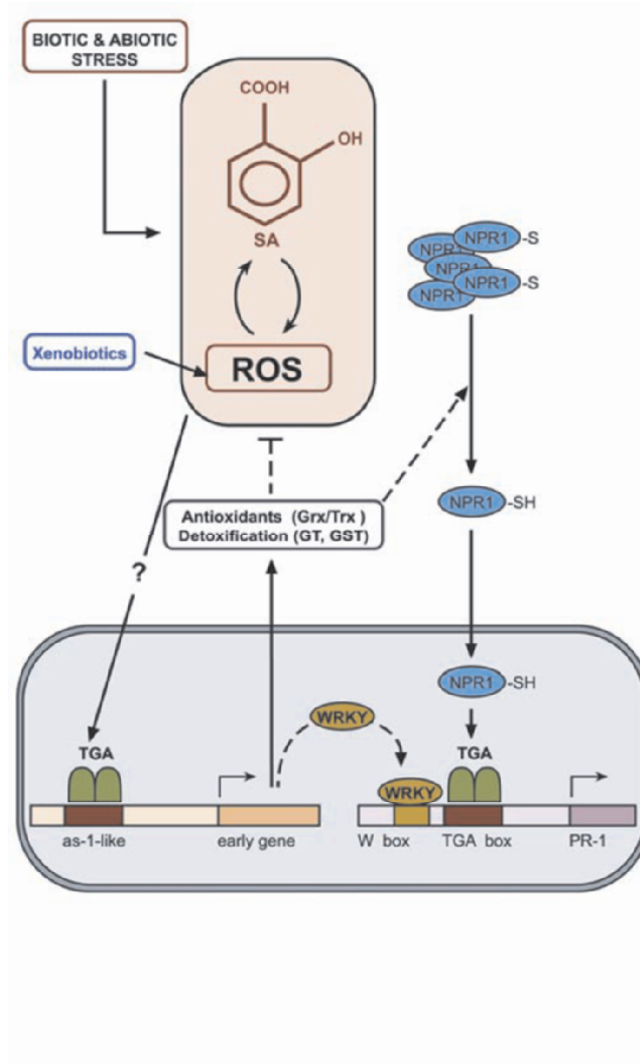

Figure 5. Hypothetical model to explain the role that some genes early activated by SA have on late genes activation. Activation of a group of genes early responsive to SA, and also to xenobiotics, seems to involve as-1-like promoter elements and TGA factors. Some of these genes encode for enzymes that have detoxifying, antioxidant and/or redox signaling functions, such as glutathione S-transferase, GST; glycosyl transferase, GT; thioredoxin, TRX; glutaredoxin, GRX; peroxidase, POX; peroxiredoxin, PRX; and cytochrome P450. We propose that activation of these genes contribute to decrease levels of ROS and to thiol reduction of NPR1. Reduced NPR1 interacts with TGA factors that increase binding to TGA boxes in late genes promoters (ie PR-1). Also, early activation of genes coding for transcription factors (particularly WRKY) by SA, can contribute to the transcriptional activation of late genes.

(TGA box and *as-1*-like). The search for overrepresented regulatory elements in defense genes co-activated by SA, the massive analysis of binding of TGA factors to promoters, and the functional analysis of selected promoters, would together contribute to clarify this issue.

Taking together, current evidence strongly suggests that SA plays a central role in controlling the cellular redox balance, which is an important aspect of the defense response.

5. ACKNOWLEDGMENTS

We gratefully acknowledge Juan Cristóbal Castro and Patricia Gana (Unidad Audiovisual, Facultad de Ciencias Biológicas, PUC) for the art work, and Alicia Minniti for improving the manuscript. This work was supported by research grant 1020593 from Fondecyt-Conicyt, Chile.

6. REFERENCES

- A.-H.-Mackerness, S., John, C.F., Jordan, B., and Thomas, B. 2001. Early signaling components in ultraviolet-B responses: distinct roles for different reactive oxygen species and nitric oxide. *FEBS Lett.*, **489**: 237-242.
- Alvarez, M.E., Pennell, R.I., Meijer, P.J., Ishikawa, A., Dixon, R.A., and Lamb, C. 1998. Reactive oxygen intermediates mediate a systemic signal network in the establishment of plant immunity. *Cell*, **92**: 773-784.
- Andreasson, E., Jenkins, T., Brodersen, P., Thorgrimsen, S., Petersen, N.H., Zhu, S., Qiu, J.L., Micheelsen, P., Rocher, A., Petersen, M., Newman, M.A., Bjorn Nielsen, H., Hirt, H., Somssich, I., Mattsson, O., and Mundy, J. 2005. The MAP kinase substrate MKS1 is a regulator of plant defense responses. *Embo J.*, **24**: 2579-2589.
- Apel, K., and Hirt, H. 2004. Reactive Oxygen Species: Metabolism, Oxidative Stress, and Signal Transduction. *Annu. Rev. Plant Biol.*, **55**: 373-399.
- Asai, T., Tena, G., Plotnikova, J., Willmann, M.R., Chiu, W.-L., Gomez-Gomez, L., Boller, T., Ausubel, F.M., and Sheen, J. 2002. MAP kinase signalling cascade in Arabidopsis innate immunity. *Nature*, **415**: 977-983.
- Benfey, P.N., Ren, L., and Chua, N.H. 1990. Tissue-specific expression from CaMV 35S enhancer subdomains in early stages of plant development. *Embo J.*, **9**: 1677-1684.
- Bi, Y.M., Kenton, P., Mur, L., Darby, R., and Draper, J. 1995. Hydrogen peroxide does not function downstream of salicylic acid in the induction of PR protein expression. *Plant J.*, **8**: 235-245.
- Blanco, F., Garretton, V., Frey, N., Dominguez, C., Perez-acle, T., Van Der Straeten, D., Jordana, X., and Holuigue, L. 2005. Identification of NPR1-dependent and independent genes early induced by salicylic acid treatment in Arabidopsis. *Plant Mol. Biol.*, **59**: 929-946.
- Borsani, O., Valpuesta, V., and Botella, M.A. 2001. Evidence for a role of salicylic acid in the oxidative damage generated by NaCl and osmotic stress in Arabidopsis seedlings. *Plant Physiol.*, **126**: 1024-1030.

- Broin, M., Cuine, S., Eymery, F., and Rey, P. 2002. The Plastidic 2-Cysteine Peroxiredoxin Is a Target for a Thioredoxin Involved in the Protection of the Photosynthetic Apparatus against Oxidative Damage. *Plant Cell*, **14**: 1417-1432.
- Buchanan, B.B., and Balmer, Y. 2005. Redox Regulation: A Broadening Horizon. *Annu. Rev. Plant Biol.*, **56**: 187-220.
- Cao, H., Bowling, S.A., Gordon, A.S., and Dong, X. 1994. Characterization of an Arabidopsis Mutant That Is Nonresponsive to Inducers of Systemic Acquired Resistance. *Plant Cell*, **6**: 1583-1592.
- Cao, H., Glazebrook, J., Clarke, J.D., Volko, S., and Dong, X. 1997. The Arabidopsis NPR1 Gene That Controls Systemic Acquired Resistance Encodes a Novel Protein Containing Ankyrin Repeats. *Cell*, **88**: 57-63.
- Cao, H., Li, X., and Dong, X. 1998. Generation of broad-spectrum disease resistance by overexpression of an essential regulatory gene in systemic acquired resistance. *Proc. Natl. Acad. Sci. USA*, **95**: 6531-6536.
- Chamnonpob, S., Willekens, H., Moeder, W., Langebartels, C., Sandermann, H., Jr., Van Montagu, M., Inze, D., and Van Camp, W. 1998. Defense activation and enhanced pathogen tolerance induced by H₂O₂ in transgenic tobacco. *Proc. Natl. Acad. Sci. USA*, **95**: 5818-5823.
- Chapple, C. 1998. Molecular-genetic analysis of plant cytochrome P450-dependent monooxygenases. *Annu. Rev. Plant Physiol. Plant Mol. Biol.*, **49**: 311-343.
- Chen, C., and Chen, Z. 2002. Potentiation of Developmentally Regulated Plant Defense Response by AtWRKY18, a Pathogen-Induced Arabidopsis Transcription Factor. *Plant Physiol.*, **129**: 706-716.
- Chen, W., and Singh, K.B. 1999. The auxin, hydrogen peroxide and salicylic acid induced expression of the Arabidopsis GST6 promoter is mediated in part by an ocs element. *Plant J.*, **19**: 667-677.
- Chen, Z., Silva, H., and Klessig, D. 1993. Active oxygen species in the induction of plant systemic acquired resistance by salicylic acid. *Science*, **262**: 1883-1886.
- Cheong, Y.H., Chang, H.-S., Gupta, R., Wang, X., Zhu, T., and Luan, S. 2002. Transcriptional Profiling Reveals Novel Interactions between Wounding, Pathogen, Abiotic Stress, and Hormonal Responses in Arabidopsis. *Plant Physiol.*, **129**: 661-677.
- Chern, M., Fitzgerald, H.A., Canlas, P.E., Navarre, D.A., and Ronald, P.C. 2005. Overexpression of a rice NPR1 homolog leads to constitutive activation of defense response and hypersensitivity to light. *Mol Plant Microbe Interact.*, **18**: 511-520.
- Chung, Y.M., Bae, Y.S., and Lee, S.Y. 2003. Molecular ordering of ROS production, mitochondrial changes, and caspase activation during sodium salicylate-induced apoptosis. *Free Rad. Biol. Med.*, **34**: 434-442.
- Clarke, S.M., Mur, L.A.J., Wood, J.E., and Scott, I.M. 2004. Salicylic acid dependent signaling promotes basal thermotolerance but is not essential for acquired thermotolerance in Arabidopsis thaliana. *Plant J.*, **38**: 432-447.
- Collinge, M.A., and Walker, J.C. 1994. Isolation of an Arabidopsis thaliana casein kinase II beta subunit by complementation in Saccharomyces cerevisiae. *Plant Mol. Biol.*, **25**: 649-658.
- Dangl, J.L., and Jones, J.D.G. 2001. Plant pathogens and integrated defence responses to infection. *Nature*, **411**: 826-833.
- Daniel, X., Lacomme, C., Morel, J.-B., and Roby, D. 1999. A novel myb oncogene homologue in Arabidopsis thaliana related to hypersensitive cell death. *Plant J.*, **20**: 57-66.
- Dat, J.F., Foyer, C.H., and Scott, I.M. 1998. Changes in Salicylic Acid and Antioxidants during Induced Thermotolerance in Mustard Seedlings. *Plant Physiol.*, **118**: 1455-1461.

- Davletova, S., Rizhsky, L., Liang, H., Shengqiang, Z., Oliver, D.J., Coutu, J., Shulaev, V., Schlauch, K., and Mittler, R. 2005. Cytosolic Ascorbate Peroxidase 1 Is a Central Component of the Reactive Oxygen Gene Network of Arabidopsis. *Plant Cell*, **17**: 268-281.
- de Leon, I.P., Sanz, A., Hamberg, M., and Castresana, C. 2002. Involvement of the Arabidopsis α DOX1 fatty acid dioxygenase in protection against oxidative stress and cell death. *Plant J.*, **29**: 61-72.
- Delaney, T.P., Friedrich, L., and Ryals, J.A. 1995. Arabidopsis signal transduction mutant defective in chemically and biologically induced disease resistance. *Proc. Natl. Acad. Sci. USA.*, **92**: 6602-6606.
- Delaney, T.P., Uknes, S., Vernooij, B., Friedrich, L., and Weymann, K. 1994. A central role of salicylic acid in plant disease resistance. *Science*, **266**: 1247-1250.
- Despres, C., Chubak, C., Rochon, A., Clark, R., Bethune, T., Desveaux, D., and Fobert, P.R. 2003. The Arabidopsis NPR1 Disease Resistance Protein Is a Novel Cofactor That Confers Redox Regulation of DNA Binding Activity to the Basic Domain/Leucine Zipper Transcription Factor TGA1. *Plant Cell*, **15**: 2181-2191.
- Despres, C., DeLong, C., Glaze, S., Liu, E., and Fobert, P.R. 2000. The Arabidopsis NPR1/NIM1 Protein Enhances the DNA Binding Activity of a Subgroup of the TGA Family of bZIP Transcription Factors. *Plant Cell*, **12**: 279-290.
- Desveaux, D., Allard, J., Brisson, N., and Sygusch, J. 2002. Crystallization and preliminary X-ray crystallographic analysis of p24, a component of the potato nuclear factor PBF-2. *Acta Cryst. D Biol Cryst.*, **58**: 296-298.
- Desveaux, D., Despres, C., Joyeux, A., Subramaniam, R., and Brisson, N. 2000. PBF-2 is a novel single-stranded DNA binding factor implicated in PR-10a gene activation in potato. *Plant Cell*, **12**: 1477-1489.
- Desveaux, D., Marechal, A., and Brisson, N. 2005. Whirly transcription factors: defense gene regulation and beyond. *Tren. Plant Sci.*, **10**: 95-102.
- Desveaux, D., Subramaniam, R., Despres, C., Mess, J.-N., Levesque, C., Fobert, P.R., Dangl, J.L., and Brisson, N. 2004. A "Whirly" Transcription Factor Is Required for Salicylic Acid-Dependent Disease Resistance in Arabidopsis. *Dev. Cell*, **6**: 229-240.
- Dietz, K.-J. 2003. Plant Peroxiredoxins. *Annu. Rev. Plant Biol.*, **54**: 93-107.
- Dixon, D.P., Laphorn, A., and Edwards, R. 2002. Plant glutathione transferases. *Genome Biol*, **3**: REVIEWS3004.
- Dong, J., Chen, C., and Chen, Z. 2003. Expression profiles of the Arabidopsis WRKY gene superfamily during plant defense response. *Plant Mol. Biol.*, **51**: 21-37.
- Dong, X. 2004. NPR1, all things considered. *Curr. Opin. Plant Biol.*, **7**: 547-552.
- Draper, J. 1997. Salicylate, superoxide synthesis and cell suicide in plant defence. *Tren. Plant Sci.*, **2**: 162-165.
- Durner, J., and Klessig, D.F. 1996. Salicylic Acid Is a Modulator of Tobacco and Mammalian Catalases. *J. Biol. Chem.*, **271**: 28492-28501.
- Durrant, W.E., and Dong, X. 2004. Systemic Acquired Resistance. *Annu. Rev. Phytopath.*, **42**: 185-209.
- Dutilleul, C., Garmier, M., Noctor, G., Mathieu, C., Chetrit, P., Foyer, C.H., and de Paepe, R. 2003. Leaf Mitochondria Modulate Whole Cell Redox Homeostasis, Set Antioxidant Capacity, and Determine Stress Resistance through Altered Signaling and Diurnal Regulation. *Plant Cell*, **15**: 1212-1226.
- Edwards, R., Dixon, D.P., and Walbot, V. 2000. Plant glutathione S-transferases: enzymes with multiple functions in sickness and in health. *Tren. Plant Sci.*, **5**: 193-198.
- Ekengren, S.K., Liu, Y., Schiff, M., Dinesh-Kumar, S.P., and Martin, G.B. 2003. Two MAPK cascades, NPR1, and TGA transcription factors play a role in Pto-mediated disease resistance in tomato. *Plant J.*, **36**: 905-917.

- Eulgem, T. 2005. Regulation of the Arabidopsis defense transcriptome. *Tren.Plant Sci.*, **10**: 71-78.
- Eulgem, T., Rushton, P.J., Robatzek, S., and Somssich, I.E. 2000. The WRKY superfamily of plant transcription factors. *Tren Plant Sci.*, **5**: 199-206.
- Falk, A., Feys, B.J., Frost, L.N., Jones, J.D., Daniels, M.J., and Parker, J.E. 1999. EDS1, an essential component of R gene-mediated disease resistance in Arabidopsis has homology to eukaryotic lipases. *Proc. Natl. Acad. Sci. USA.*, **96**: 3292-3297.
- Fan, W., and Dong, X. 2002. In Vivo Interaction between NPR1 and Transcription Factor TGA2 Leads to Salicylic Acid-Mediated Gene Activation in Arabidopsis. *Plant Cell*, **14**: 1377-1389.
- Feys, B.J., Moisan, L.J., Newman, M.A., and Parker, J.E. 2001. Direct interaction between the Arabidopsis disease resistance signaling proteins, EDS1 and PAD4. *Embo J.*, **20**: 5400-5411.
- Finkemeier, I., Goodman, M., Lamkemeyer, P., Kandlbinder, A., Sweetlove, L.J., and Dietz, K.-J. 2005. The Mitochondrial Type II Peroxiredoxin F Is Essential for Redox Homeostasis and Root Growth of Arabidopsis thaliana under Stress. *J. Biol. Chem.*, **280**: 12168-12180.
- Fitzgerald, H.A., Canlas, P.E., Chern, M.S., and Ronald, P.C. 2005. Alteration of TGA factor activity in rice results in enhanced tolerance to Xanthomonas oryzae pv. oryzae. *Plant J.*, **43**: 335-347.
- Fobert, P.R., and Despres, C. 2005. Redox control of systemic acquired resistance. *Curr. Opin. Plant Biol.*, **8**: 378-382.
- Foley, R.C., and Singh, K.B. 2004. TGA5 acts as a positive and TGA4 acts as a negative regulator of ocs element activity in Arabidopsis roots in response to defence signals. *FEBS Lett.*, **563**: 141-145.
- Foyer, C.H., and Noctor, G. 2005. Redox Homeostasis and Antioxidant Signaling: A Metabolic Interface between Stress Perception and Physiological Responses. *Plant Cell*, **17**: 1866-1875.
- Friedrich, L., Lawton, K., Dietrich, R., Willits, M., Cade, R., and Ryals, J. 2001. NIM1 overexpression in Arabidopsis potentiates plant disease resistance and results in enhanced effectiveness of fungicides. *Mol Plant Micro. Int.*, **14**: 1114-1124.
- Gaffney, T., Friedrich, L., Vernooij, B., Negrotto, D., Nye, G., Uknes, S., Ward, E., Kessmann, H., and Ryals, J. 1993. Requirement of salicylic acid for the induction of systemic acquired resistance. *Science*, **250**: 754-756.
- Garretón, V., Carpinelli, J., Jordana, X., and Holuigue, L. 2002. The as-1 Promoter Element Is an Oxidative Stress-Responsive Element and Salicylic Acid Activates It via Oxidative Species. *Plant Physiol.*, **130**: 1516-1526.
- Glazebrook, J. 2001. Genes controlling expression of defense responses in Arabidopsis -- 2001 status. *Curr. Opin.Plant Biol.*, **4**: 301-308.
- Glazebrook, J. 2005. Contrasting Mechanisms of Defense Against Biotrophic and Necrotrophic Pathogens. *Annu. Rev. Phytopath.*, **43**: 9.1-9.13.
- Glazebrook, J., Chen, W., Estes, B., Chang, H.-S., Nawrath, C., Metraux, J.-P., Zhu, T., and Katagiri, F. 2003. Topology of the network integrating salicylate and jasmonate signal transduction derived from global expression phenotyping. *Plant J.*, **34**: 217-228.
- Glazebrook, J., Rogers, E.E., and Ausubel, F.M. 1996. Isolation of Arabidopsis Mutants With Enhanced Disease Susceptibility by Direct Screening. *Genetics*, **143**: 973-982.
- Grant, J.J., and Loake, G.J. 2000. Role of Reactive Oxygen Intermediates and Cognate Redox Signaling in Disease Resistance. *Plant Physiol.*, **124**: 21-30.
- Hartmann, U., Sagasser, M., Mehrtens, F., Stracke, R., and Weisshaar, B. 2005. Differential combinatorial interactions of cis-acting elements recognized by R2R3-MYB, BZIP, and

- BHLH factors control light-responsive and tissue-specific activation of phenylpropanoid biosynthesis genes. *Plant Mole. Biol.*, **57**: 155-171.
- Hepworth, S.R., Zhang, Y., McKim, S., Li, X., and Haughn, G.W. 2005. BLADE-ON-PETIOLE-Dependent Signaling Controls Leaf and Floral Patterning in Arabidopsis. *Plant Cell*, **17**: 1434-1448.
- Hidalgo, P., Garretton, V., Berrios, C.G., Ojeda, H., Jordana, X., and Holuigue, L. 2001. A Nuclear Casein Kinase 2 Activity Is Involved in Early Events of Transcriptional Activation Induced by Salicylic Acid in Tobacco. *Plant Physiol.*, **125**: 396-405.
- Hiraga, S., Sasaki, K., Ito, H., Ohashi, Y., and Matsui, H. 2001. A Large Family of Class III Plant Peroxidases. *Plant Cell Physiol.*, **42**: 462-468.
- Hoffmann-Sommergruber, K. 2002. Pathogenesis-related (PR)-proteins identified as allergens. *Biochem. Soc. Trans.*, **30**: 930-935.
- Hong, Z., Zhang, Z., Olson, J., and Verma D. 2001. A Novel UDP-Glucose Transferase Is Part of the Callose Synthase Complex and Interacts with Phragmoplastin at the Forming Cell Plate. *Plant Cell*, **13**: 769-779.
- Horvath, D.M., Huang, D.J., and Chua, N.H. 1998. Four classes of salicylate-induced tobacco genes. *Mol Plant Micro. Inter.*, **11**: 895-905.
- Ichimura, K. 2000. Various abiotic stresses rapidly activate Arabidopsis MAP kinases ATMPK4 and ATMPK6. *Plant J.*, **24**: 655-665.
- Jabs, T., Dietrich, R.A., and Dangl, J.L. 1996. Initiation of runaway cell death in an Arabidopsis mutant by extracellular superoxide. *Science*, **273**: 1853-1856.
- Jackson, R.G., Lim, E.-K., Li, Y., Kowalczyk, M., Sandberg, G., Hoggett, J., Ashford, D.A., and Bowles, D.J. 2001. Identification and Biochemical Characterization of an Arabidopsis Indole-3-acetic Acid Glucosyltransferase. *J. Biol. Chem.*, **276**: 4350-4356.
- Jacquot, J.-P., Gelhaye, E., Rouhier, N., Corbier, C., Didierjean, C., and Aubry, A. 2002. Thioredoxins and related proteins in photosynthetic organisms: molecular basis for thiol dependent regulation. *Biochem. Pharm.*, **64**: 1065-1069.
- Jakoby, M., Weisshaar, B., Droge-Laser, W., Vicente-Carbajosa, J., Tiedemann, J., Kroj, T., and Parcy, F. 2002. bZIP transcription factors in Arabidopsis. *Tren. Plant Sci.*, **7**: 106-111.
- Jin, H., Cominelli, E., Bailey, P., Parr, A., Mehrtens, F., Jones, J., Tonelli, C., Weisshaar, B., and Martin, C. 2000. Transcriptional repression by AtMYB4 controls production of UV-protecting sunscreens in Arabidopsis. *EMBO J.*, **19**: 6150-6161.
- Jirage, D., Tootle, T.L., Reuber, T.L., Frost, L.N., Feys, B.J., Parker, J.E., Ausubel, F.M., and Glazebrook, J. 1999. Arabidopsis thaliana PAD4 encodes a lipase-like gene that is important for salicylic acid signaling. *Proc. Natl. Acad. Sci. USA.*, **96**: 13583-13588.
- Jirage, D., Zhou, N., Cooper, B., Clarke, J.D., Dong, X., and Glazebrook, J. 2001. Constitutive salicylic acid-dependent signaling in cpr1 and cpr6 mutants requires PAD4. *Plant J.*, **26**: 395-407.
- Johnson, C., Boden, E., and Arias, J. 2003. Salicylic Acid and NPR1 Induce the Recruitment of trans-Activating TGA Factors to a Defense Gene Promoter in Arabidopsis. *Plant Cell*, **15**: 1846-1858.
- Johnson, C., Boden, E., Desai, M., Pascuzzi, P., and Arias, J. 2001. In vivo target promoter-binding activities of a xenobiotic stress-activated TGA factor. *Plant J.*, **28**: 237-243.
- Joo, J.H., Wang, S., Chen, J.G., Jones, A.M., and Fedoroff, N.V. 2005. Different Signaling and Cell Death Roles of Heterotrimeric G Protein {alpha} and {beta} Subunits in the Arabidopsis Oxidative Stress Response to Ozone. *Plant Cell*, **17**: 957-970.
- Kalde, M., Barth, M., Somssich, I., and Lippok, B. 2003. Members of the Arabidopsis WRKY group III transcription factors are part of different plant defense signaling pathways. *Mole. Plant Micro. Inter.*, **16**: 295-305.

- Kampranis, S., Damianova, R., Atallah, M., Toby, G., Kondi, G., Tsiachlis, P.N., and Makris, A.M., 2000. A Novel Plant Glutathione S-Transferase/Peroxidase Suppresses Bax Lethality in Yeast. *J. Biol. Chem.*, **275**: 29207-29216.
- Kang, H.-G., and Klessig, D.F. 2005. Salicylic acid-inducible *Arabidopsis* CK2-like activity phosphorylates TGA2. *Plant Mole. Biol.*, **57**: 541-557.
- Katagiri, F., Lam, E., and Chua, N.-H. 1989. Two tobacco DNA-binding proteins with homology to the nuclear factor CREB. *Nature*, **340**: 727-730.
- Katagiri, F., Seipel, K., and Chua, N.H. 1992. Identification of a novel dimer stabilization region in a plant bZIP transcription activator. *Mol. Cell. Biol.*, **12**: 4809-4816.
- Kawano, T. 2003. Roles of the reactive oxygen species-generating peroxidase reactions in plant defense and growth induction. *Plant Cell Rep.*, **21**: 829-837.
- Kawano, T., Pinontoan, R., Uozumi, N., Morimitsu, Y., Miyake, C., Asada, K., and Muto, S. 2000. Phenylethylamine-Induced Generation of Reactive Oxygen Species and Ascorbate Free Radicals in Tobacco Suspension Culture: Mechanism for Oxidative Burst Mediating Ca²⁺ Influx. *Plant Cell Physiol.*, **41**: 1259-1266.
- Keegstra, K., and Raikhel, N. 2001 Plant glycosyltransferases. *Curr. Opin. Plant Biol.*, **4**: 219-224.
- Kegler, C., Lenk, I., Krawczyk, S., Scholz, R., and Gatz, C. 2004. Functional characterization of tobacco transcription factor TGA2.1. *Plant Mol. Biol.*, **55**: 153-164
- Kilili, K.G., Atanassova, N., Vardanyan, A., Clatot, N., Al-Sabarna, K., Kanellopoulos, P.N., Makris, A.M., and Kampranis, S.C. 2004. Differential Roles of Tau Class Glutathione S-Transferases in Oxidative Stress. *J. Biol. Chem.*, **279**: 24540-24551.
- Kim, H.S., and Delaney, T.P. 2002. Over-expression of TGA5, which encodes a bZIP transcription factor that interacts with NIM1/NPR1, confers SAR-independent resistance in *Arabidopsis thaliana* to *Peronospora parasitica*. *Plant J.*, **32**: 151-163.
- Kinkema, M., Fan, W., and Dong, X. 2000. Nuclear Localization of NPR1 Is Required for Activation of PR Gene Expression. *Plant Cell*, **12**: 2339-2350.
- Klessig, D.F., Durner, J., Noad, R., Navarre, D.A., Wendehenne, D., Kumar, D., Zhou, J.M., Shah, J., Zhang, S., Kachroo, P., Trifa, Y., Pontier, D., Lam, E., and Silva, H. 2000. Nitric oxide and salicylic acid signaling in plant defense. *Proc. Natl. Acad. Sci. USA.*, **97**: 8849-8855.
- Klinedinst, S., Pascuzzi, P., Redman, J., Desai, M., and Arias, J. 2000. A xenobiotic-stress-activated transcription factor and its cognate target genes are preferentially expressed in root tip meristems. *Plant Mol. Biol.*, **42**: 679-688.
- Krawczyk, S., Thurow, C., Niggeweg, R., and Gatz, C. 2002. Analysis of the spacing between the two palindromes of activation sequence-1 with respect to binding to different TGA factors and transcriptional activation potential. *Nucl. Acids Res.*, **30**: 775-781.
- Kreps, J.A., Wu, Y., Chang, H.-S., Zhu, T., Wang, X., and Harper, J.F. 2002. Transcriptome Changes for *Arabidopsis* in Response to Salt, Osmotic, and Cold Stress. *Plant Physiol.*, **130**: 2129-2141.
- Lam, E., Benfey, P.N., Gilmartin, P.M., Fang, R.X., and Chua, N.H. 1989. Site-specific mutations alter in vitro factor binding and change promoter expression pattern in transgenic plants. *Proc. Natl. Acad. Sci. USA.*, **86**: 7890-7894.
- Lam, E., Kato, N., and Lawton, M. 2001. Programmed cell death, mitochondria and the plant hypersensitive response. *Nature*, **411**: 848-853.
- Lam, E., and Lam, Y. 1995. Binding site requirements and differential representation of TGF factors in nuclear ASF-1 activity. *Nucl. Acids Res.*, **23**: 3778-3785.
- Larkindale, J., and Knight, M. 2002. Protection against Heat Stress-Induced Oxidative Damage in *Arabidopsis* Involves Calcium, Abscisic Acid, Ethylene, and Salicylic Acid. *Plant Physiol.*, **128**: 682-695.

- Lebel, E., Heifetz, P., Thorne, L., Uknes, S., Ryals, J., and Ward, E. 1998. Functional analysis of regulatory sequences controlling PR-1 gene expression in Arabidopsis. *Plant J.*, **16**: 223-233.
- Lee, H.-i., and Raskin, I. 1999. Purification, Cloning, and Expression of a Pathogen Inducible UDP-glucose:Salicylic Acid Glucosyltransferase from Tobacco. *J. Biol. Chem.*, **274**: 36637-36642.
- Lee, K.-t., Hirano, H., Yamakawa, T., Kodama, T., Igarashi, Y., and Shimomura, K. 2001a. Responses of transformed root culture of *Atropa belladonna* to salicylic acid stress. *J. Biosci. Bioeng.*, **91**: 586-589.
- Lee, M., Qi, M., and Yang, Y. 2001b. A novel jasmonic acid-inducible rice myb gene associates with fungal infection and host cell death. *Mol Plant Micro. Inter.*, **14**: 527-535.
- Lemaire, S.D., Guillon, B., Le Marechal, P., Keryer, E., Miginiac-Maslow, M., and Decottignies, P. 2004. New thioredoxin targets in the unicellular photosynthetic eukaryote *Chlamydomonas reinhardtii*. *Proc. Natl. Acad. Sci. USA.*, **101**: 7475-7480.
- Leon, J., Lawton, M.A., and Raskin, I. 1995. Hydrogen Peroxide Stimulates Salicylic Acid Biosynthesis in Tobacco. *Plant Physiol.*, **108**: 1673-1678.
- Li, J., and al, e. 2004. The WRKY70 transcription factor: a node of convergence for jasmonate-mediated and salicylate-mediated signals in plant defense. *Plant Cell*, **16**: 319-331.
- Li, X., Zhang, Y., Clarke, J.D., Li, Y., and Dong, X. 1999. Identification and cloning of a negative regulator of systemic acquired resistance, SN1, through a screen for suppressors of npr1-1. *Cell*, **98**: 329-339.
- Li, Y., Baldauf, S., Lim, E.K., and Bowles, D.J. 2001. Phylogenetic analysis of the UDP-glycosyltransferase multigene family of Arabidopsis thaliana. *J Biol. Chem.*, **276**: 4338-4343.
- Lin, W.-C., Lu, C.-F., Wu, J.-W., Cheng, M.-L., Lin, Y.-M., Yang, N.-S., Black, L., Green, S.K., Wang, J.-F., and Cheng, C.-P. 2004. Transgenic tomato plants expressing the Arabidopsis *NPR1* gene display enhanced resistance to a spectrum of fungal and bacterial diseases. *Trans. Res.*, **13**: 567-581.
- Liu, G., Holub, E.B., Alonso, J.M., Ecker, J.R., and Fobert, P.R. 2005. An Arabidopsis NPR1-like gene, NPR4, is required for disease resistance. *Plant J.*, **41**: 304-318.
- Liu, X., and Lam, E. 1994. Two binding sites for the plant transcription factor ASF-1 can respond to auxin treatments in transgenic tobacco. *J. Biol. Chem.*, **269**: 668-675.
- Liu, Y., Schiff, M., Marathe, R., and Dinesh-Kumar, S.P. 2002. Tobacco Rar1, EDS1 and NPR1/NIM1 like genes are required for N-mediated resistance to tobacco mosaic virus. *Plant J.*, **30**: 415-429.
- Loyall, L., Uchida, K., Braun, S., Furuya, M., and Frohnmeyer, H. 2000. Glutathione and a UV Light-Induced Glutathione S-Transferase Are Involved in Signaling to Chalcone Synthase in Cell Cultures. *Plant Cell*, **12**: 1939-1950.
- Malamy, J., Carr, J.P., Klessig, D.F., and Raskin, I. 1990. Salicylic acid: a likely endogenous signal in the resistance response of tobacco to viral infection. *Science*, **250**: 1002-1004.
- Maleck, K., Levine, A., Eulgem, T., Morgan, A., Schmid, J., Lawton, K.A., Dangel, J.L., and Dietrich, R.A. 2000. The transcriptome of Arabidopsis thaliana during systemic acquired resistance. *Nat. Genet.*, **26**: 403-410.
- Marchand, C., Le Marechal, P., Meyer, Y., Miginiac-Maslow, M., Issakidis-Bourguet, E., and Decottignies, P. 2004. New targets of Arabidopsis thioredoxins revealed by proteomic analysis. *Proteomics*, **4**: 2696-2706.
- Marrs, K.A. 1996. The Functions and Regulation of Glutathione S-transferases in plants. *Annu. Rev. Plant Physiol. Plant Mol. Biol.*, **47**: 127-158.
- Mateo, A., Muhlenbock, P., Rusterucci, C., Chang, C.C., Miszalski, Z., Karpinska, B., Parker, J.E., Mullineaux, P.M., and Karpinski, S. 2004. Lesion Simulating Disease 1 is required

- for acclimation to conditions that promote excess excitation energy. *Plant Physiol.*, **136**: 2818-2830.
- Maxwell, D.P., Nickels, R., and McIntosh, L. 2002. Evidence of mitochondrial involvement in the transduction of signals required for the induction of genes associated with pathogen attack and senescence. *Plant J.*, **29**: 269-279.
- Maxwell, D.P., Wang, Y., and McIntosh, L. 1999. The alternative oxidase lowers mitochondrial reactive oxygen production in plant cells. *Proc. Natl. Acad. Sci. USA.*, **96**: 8271-8276.
- Mehrtens, F., Kranz, H., Bednarek, P., and Weisshaar, B. 2005. The Arabidopsis Transcription Factor MYB12 Is a Flavonol-Specific Regulator of Phenylpropanoid Biosynthesis. *Plant Physiol.*, **138**: 1083-1096.
- Metraux, J.-P. 2002. Recent breakthroughs in the study of salicylic acid biosynthesis. *Tren.Plant Sci.*, **7**: 332-334.
- Miao, Z., Liu, X., and Lam, E. 1994. TGA3 is a distinct member of the TGA family of bZIP transcription factors in Arabidopsis thaliana. *Plant Mo. Biol.*, **25**: 1-11.
- Mittler, R. 2002. Oxidative stress, antioxidants and stress tolerance. *Tren. Plant Sci.*, **7**: 405-410.
- Morris, K., -Mackerness, S.A.-H., Page, T., John, C.F., Murphy, A.M., Carr, J.P., and Buchanan-Wollaston, V. 2000. Salicylic acid has a role in regulating gene expression during leaf senescence. *Plant J.*, **23**: 677-685.
- Mou, Z., Fan, W., and Dong, X. 2003. Inducers of Plant Systemic Acquired Resistance Regulate NPR1 Function through Redox Changes. *Cell*, **113**: 935-944.
- Mur, L.A., Kenton, P., and Draper, J. 2005. *In planta* measurements of oxidative bursts elicited by avirulent and virulent bacterial pathogens suggests that H₂O₂ is insufficient to elicit cell death in tobacco. *Plant Cell Environ.*, **28**: 548-561.
- Narusaka, Y., Narusaka, M., Seki, M., Umezawa, T., Ishida, J., Nakajima, M., Enju, A., and Shinozaki, K. 2004. Crosstalk in the responses to abiotic and biotic stresses in Arabidopsis: Analysis of gene expression in cytochrome P450 gene superfamily by cDNA microarray. *Plant Mol. Biol.*, **55**: 327-342.
- Nawrath, C., Heck, S., Parinshawong, N., and Metraux, J.-P. 2002. EDS5, an Essential Component of Salicylic Acid-Dependent Signaling for Disease Resistance in Arabidopsis, Is a Member of the MATE Transporter Family. *Plant Cell*, **14**: 275-286.
- Neuenschwander, U., Vernooij, B., Friedrich, L., Uknes, S., Kessmann, H., and Ryals, J. 1995. Is hydrogen peroxide a second messenger of salicylic acid in systemic acquired resistance? *Plant J.*, **8**: 227-233.
- Neuhaus, G., Neuhaus-Url, G., Katagiri, F., Seipel, K., and Chua, N.H. 1994. Tissue-Specific Expression of as-1 in Transgenic Tobacco. *Plant Cell*, **6**: 827-834.
- Niefind, K., Guerra, B., Pinna, L., Issinger, O., and Schomburg, D. 1998. Crystal structure of the catalytic subunit of protein kinase CK2 from *Zea mays* at 2.1 Å resolution. *EMBO J.*, **17**: 2451-2462.
- Niggeweg, R., Thurow, C., Kegler, C., and Gatz, C. 2000a. Tobacco Transcription Factor TGA2.2 Is the Main Component of as-1-binding Factor ASF-1 and Is Involved in Salicylic Acid- and Auxin-inducible Expression of as-1-containing Target Promoters. *J. Biol. Chem.*, **275**: 19897-19905.
- Niggeweg, R., Thurow, C., Weigel, R., Pfitzner, U., and Gatz, C. 2000b. Tobacco TGA factors differ with respect to interaction with NPR1, activation potential and DNA-binding properties. *Plant Mol. Biol.*, **42**: 775-788.
- O'Donnell, P.J., Truesdale, Mark R., Calvert, Caroline M., Dorans, Alison, Roberts, Michael R., and Bowles, D. J. 1998. A novel tomato gene that rapidly responds to wound and pathogen-related signals. *Plant J.*, **14**: 137-142.

- Orozco-Cardenas, M.L., Narvaez-Vasquez, J., and Ryan, C.A. 2001. Hydrogen Peroxide Acts as a Second Messenger for the Induction of Defense Genes in Tomato Plants in Response to Wounding, Systemin, and Methyl Jasmonate. *Plant Cell*, **13**: 179-191.
- Overmyer, K., Brosche, M., and Kangasjarvi, J. 2003. Reactive oxygen species and hormonal control of cell death. *Tren. Plant Sci.*, **8**: 335-342.
- Pascuzzi, P., Hamilton, D., Bodily, K., and Arias, J. 1998. Auxin-induced stress potentiates trans-activation by a conserved plant basic/leucine-zipper factor. *J. Biol. Chem.*, **273**: 26631-26637.
- Pasqualini, S., Della Torre, G., Ferranti, F., Ederli, L., Piccioni, C., Reale, L., and Antonielli, M. 2002. Salicylic acid modulates ozone-induced hypersensitive cell death in tobacco plants. *Physiol. Plant.*, **115**: 204-212.
- Pasqualini, S., Piccioni, C., Reale, L., Ederli, L., Della Torre, G., and Ferranti, F. 2003. Ozone-Induced Cell Death in Tobacco Cultivar Bel W3 Plants. The Role of Programmed Cell Death in Lesion Formation. *Plant Physiol.*, **133**: 1122-1134.
- Peracchia, G., Jensen, A.B., Culianez-Macia, F.A., Grosset, J., Goday, A., Issinger, O.-G., and Pages, M. 1999. Characterization, subcellular localization and nuclear targeting of casein kinase 2 from *Zea mays*. *Plant Mol. Biol.*, **40**: 199-211.
- Petersen, M., Mundy, J., and otros. 2000. Arabidopsis map kinase 4 negatively regulates systemic acquired resistance. *Cell*, **103**: 1111-1120.
- Pieterse, C.M., and Van Loon, L. 2004. NPR1: the spider in the web of induced resistance signaling pathways. *Curr. Opin. Plant Biol.*, **7**: 456-464.
- Pieterse, C.M., van Wees, S.C., van Pelt, J.A., Knoester, M., Laan, R., Gerrits, H., Weisbeek, P.J., and van Loon, L.C. 1998. A novel signaling pathway controlling induced systemic resistance in Arabidopsis. *Plant Cell*, **10**: 1571-1580.
- Pontier, D., Miao, Z.H., and Lam, E. 2001. Trans-dominant suppression of plant TGA factors reveals their negative and positive roles in plant defense responses. *Plant J.*, **27**: 529-538.
- Pontier, D., Privat, I., Trifa, Y., Zhou, J.M., Klessig, D.F., and Lam, E. 2002. Differential regulation of TGA transcription factors by post-transcriptional control. *Plant J.*, **32**: 641-653.
- Pylatuik, J., and Fobert, P.R. 2005. Comparison of transcript profiling on Arabidopsis microarray platform technologies. *Plant Mol. Biol.*, **58**: 609-624.
- Qin, X.F., Holuigue, L., Horvath, D.M., and Chua, N.H. 1994. Immediate Early Transcription Activation by Salicylic Acid via the Cauliflower Mosaic Virus as-1 Element. *Plant Cell*, **6**: 863-874.
- Rao, M.V., and Davis, K.R. 1999. Ozone-induced cell death occurs via two distinct mechanisms in Arabidopsis: the role of salicylic acid. *Plant J.*, **17**: 603-614.
- Rao, M.V., Paliyath, G., Ormrod, D.P., Murr, D.P., and Watkins, C.B. 1997. Influence of Salicylic Acid on H₂O₂ Production, Oxidative Stress, and H₂O₂-Metabolizing Enzymes (Salicylic Acid-Mediated Oxidative Damage Requires H₂O₂). *Plant Physiol.*, **115**: 137-149.
- Rhee, S.Y., Beavis, W., Berardini, T.Z., Chen, G., Dixon, D., Doyle, A., Garcia-Hernandez, M., Huala, E., Lander, G., Montoya, M., Miller, N., Mueller, L.A., Mundodi, S., Reiser, L., Tacklind, J., Weems, D.C., Wu, Y., Xu, I., Yoo, D., Yoon, J., and Zhang, P. 2003. The Arabidopsis Information Resource (TAIR): a model organism database providing a centralized, curated gateway to Arabidopsis biology, research materials and community. *Nucl. Acids Res.*, **31**: 224-228.
- Roberts, M.R., Darby, R., Lim, E.K., Draper, J., Boeles, D.J., 1999. Differential regulation of a glucosyl transferase gene homologue during defence responses in tobacco. *J. Exp. Bot.*, **50**: 407-410.

- Romeis, T., Piedras, P., Zhang, S., Klessig, D., Hirt, H., and Jones, J. 1999. Rapid Avr9- and Cf-9 -dependent activation of MAP kinases in tobacco cell cultures and leaves: convergence of resistance gene, elicitor, wound, and salicylate responses. *Plant Cell*, **11**: 273-287.
- Ross, J., Li, Y., Lim, E.-K., and Bowles, D. 2001. Higher plant glycosyltransferases. *Gen. Biol.*, **2**: reviews 3004.3001 - reviews3004.3006.
- Rouhier, N., Gelhaye, E., Gualberto, J.M., Jordy, M.-N., De Fay, E., Hirasawa, M., Duplessis, S., Lemaire, S.D., Frey, P., Martin, F., Manieri, W., Knaff, D.B., and Jacquot, J.-P. 2004. Poplar Peroxiredoxin Q. A Thioredoxin-Linked Chloroplast Antioxidant Functional in Pathogen Defense. *Plant Physiol.*, **134**: 1027-1038.
- Rouhier, N., Gelhaye, E., Sautiere, P.-E., Brun, A., Laurent, P., Tagu, D., Gerard, J., de Fay, E., Meyer, Y., and Jacquot, J.-P. 2001. Isolation and Characterization of a New Peroxiredoxin from Poplar Sieve Tubes That Uses Either Glutaredoxin or Thioredoxin as a Proton Donor. *Plant Physiol.*, **127**: 1299-1309.
- Roxas, V., Smith, R.K. Jr., Allen, E.R., Allen, R.D., 1997. Overexpression of glutathione S-transferase/glutathione peroxidase enhances the growth of transgenic tobacco seedlings during stress. *Nature Biotech.*, **15**: 988-991.
- Rusterucci, C., Aviv, D.H., Holt, B.F., 3rd, Dangl, J.L., and Parker, J.E. 2001. The disease resistance signaling components EDS1 and PAD4 are essential regulators of the cell death pathway controlled by LSD1 in Arabidopsis. *Plant Cell*, **13**: 2211-2224.
- Salinas, P., Bantignies, B., Tapia, J., Jordana, X., and Holuigue, L. 2001. Cloning and characterization of the cDNA coding for the catalytic alpha subunit of CK2 from tobacco. *Mol Cell Biochem.*, **227**: 120-135.
- Sandermann, H.J. 1992. Plant metabolism of xenobiotics. *Trends Biochem. Sci.*, **17**: 82-84.
- Sappl, P.G., Onate-Sanchez, L., Singh, K.B., and Millar, A.H. 2004. Proteomic analysis of glutathione S-transferases of Arabidopsis thaliana reveals differential salicylic acid-induced expression of the plant-specific phi and tau classes. *Plant Mol. Biol.*, **54**: 205-219.
- Schiermeyer, A., Thurow, C., and Gatz, C. 2003. Tobacco bZIP factor TGA10 is a novel member of the TGA family of transcription factors. *Plant Mol. Biol.*, **51**: 817-829.
- Schoenbohm, C., Martens S., Eder, C., Forkmann, G., Weisshaar, B., 2000. Identification of the Arabidopsis thaliana flavonoid 3'-hydroxylase gene and functional expression of the encoded P450 enzyme. *Biol. Chem.*, **381**: 749-753.
- Schuler, M.A., and Werck-Reichhart, D. 2003. Functional Genomics of P450s. *Annu. Rev. Plant Biol.*, **54**: 629-667.
- Scott, I.M., Clarke, S.M., Wood, J.E., and Mur, L.A.J. 2004. Salicylate Accumulation Inhibits Growth at Chilling Temperature in Arabidopsis. *Plant Physiol.*, **135**: 1040-1049.
- Shah, J. 2005. Lipids, Lipases, and Lipid-Modifying Enzymes in Plant Disease Resistance. *Annu Rev Phytopathol.* **43**: 229-260.
- Shah, J., Tsui, F., and Klessig, D.F. 1997. Characterization of a salicylic acid-insensitive mutant (sai1) of Arabidopsis thaliana, identified in a selective screen utilizing the SA-inducible expression of the tms2 gene. *Mol Plant Microbe Interact.*, **10**: 69-78.
- Speir, E., Yu, Z.-X., Ferrans, V.J., Huang, E.-S., and Epstein, S.E. 1998. Aspirin Attenuates Cytomegalovirus Infectivity and Gene Expression Mediated by Cyclooxygenase-2 in Coronary Artery Smooth Muscle Cells. *Circ. Res.*, **83**: 210-216.
- Stracke, R., Weber, M., and Wagner, B. 2001. The R2R3-MYB gene family in Arabidopsis thaliana. *Curr. Opin. Plant Biol.*, **4**: 447-456.
- Strompen, G., Gruner, R., and Pfitzner, U.M. 1998. An as-1-like motif controls the level of expression of the gene for the pathogenesis-related protein 1a from tobacco. *Plant Mol. Biol.*, **37**: 871-883.

- Subramaniam, R., Desveaux, D., Spickler, C., Michnick, S.W., and Brisson, N. 2001. Direct visualization of protein interactions in plant cells. *Nature Biotech.*, **19**: 769-772.
- Sugimoto, K., Takeda, S., and Hirochika, H. 2000. MYB-Related Transcription Factor NtMYB2 Induced by Wounding and Elicitors is a Regulator of the Tobacco Retrotransposon Tto1 and Defense-Related Genes. *Plant Cell*, **12**: 2511-2528.
- Surplus, S.L., Jordan, B.R., Murphy, A.M., Carr, J.P., Thomas, B., and Mackerness, S.A.H. 1998. Ultraviolet-B-induced responses in *Arabidopsis thaliana*: role of salicylic acid and reactive oxygen species in the regulation of transcripts encoding photosynthetic and acidic pathogenesis-related proteins. *Plant Cell Environ.*, **21**: 685-694.
- Thurow, C., Schiermeyer, A., Krawczyk, S., Butterbrodt, T., Nikolov, K., and Gatz, C. 2005. Tobacco bZIP transcription factor TGA2.2 and related factor TGA2.1 have distinct roles in plant defense responses and plant development. *Plant J.*, **44**: 100-113.
- Tohge, T., Nishiyama, Y., Yokota Hirai, M., Yano, M., Nakajim, J., Awazuhara, M., Inoue, E., Takahashi, H., Goodenow, D., Kitayama, M., Noji, M., Yamazaki, M., and Saito, K. 2005. Functional genomics by integrated analysis of metabolome and transcriptome of *Arabidopsis* plants over-expressing an MYB transcription factor. *Plant J.* **42**: 218-235.
- Uknes, S., Dincher, S., Friedrich, L., Negrotto, D., Williams, S., Thompson-Taylor, H., Potter, S., Ward, E., and Ryals, J. 1993. Regulation of pathogenesis-related protein-1a gene expression in tobacco. *Plant Cell*, **5**: 159-169.
- Ulmasov, T., Hagen, G., and Guilfoyle, T. 1994. The ocs element in the soybean GH2/4 promoter is activated by both active and inactive auxin and salicylic acid analogues. *Plant Mol. Biol.*, **26**: 1055-1064.
- Uquillas, C., Letelier, I., Blanco, F., Jordana, X., and Holuigue, L. 2004. NPR1-independent activation of immediate early salicylic acid-responsive genes in *Arabidopsis*. *Mol. Plant Microbe Interact.*, **17**: 34-42.
- Van Camp, W., Capiou, K., Van Montagu, M., Inze, D., and Slooten, L. 1996. Enhancement of oxidative stress tolerance in transgenic tobacco plants overproducing Fe-superoxide dismutase in chloroplasts. *Plant Physiol.*, **112**: 1703-1714.
- Van Lonn, L.C., and Van Strien, E.A. 1999. The families of pathogenesis-related proteins, their activities, and comparative analysis of PR-1 type proteins. *Physiol. Mol. Plant Path.*, **55**: 85-97.
- Van Loon LC, v.K.A. 1970. Polyacrylamide disc electrophoresis of the soluble leaf proteins from *Nicotiana tabacum* var. "Samsun" and "Samsun NN". II. Changes in protein constitution after infection with tobacco mosaic virus. *Virology*, **40**: 190-211.
- Vanderauwera, S., Zimmermann, P., Rombauts, S., Vandenabeele, S., Langebartels, C., Groussin, W., Inze, D., and Van Breusegem, F. 2005. Genome-Wide Analysis of Hydrogen Peroxide-Regulated Gene Expression in *Arabidopsis* Reveals a High Light-Induced Transcriptional Cluster Involved in Anthocyanin Biosynthesis. *Plant Physiol.*, **139**: 806-821.
- Wang, D., Weaver, N.D., Kesarwani, M., and Dong, X. 2005. Induction of Protein Secretory Pathway Is Required for Systemic Acquired Resistance. *Science*, **308**: 1036-1040.
- Weigel, R.R., Bauscher, C., Pfitzner, A.J., and Pfitzner, U.M. 2001. NIMIN-1, NIMIN-2 and NIMIN-3, members of a novel family of proteins from *Arabidopsis* that interact with NPR1/NIM1, a key regulator of systemic acquired resistance in plants. *Plant Mol. Biol.*, **46**: 143-160.
- Weigel, R.R., Pfitzner, U.M., and Gatz, C. 2005. Interaction of NIMIN1 with NPR1 Modulates PR Gene Expression in *Arabidopsis*. *Plant Cell*, **17**: 1279-1291.
- Wiermer, M., Feys, B.J., and Parker, J.E. 2005. Plant immunity: the EDS1 regulatory node. *Curr. Opin. Plant Biol.*, **8**: 383-389.

- Wildermuth, M.C., Dewdney, J., Wu, G., and Ausubel, F.M. 2001. Isochorismate synthase is required to synthesize salicylic acid for plant defence. *Nature*, **414**: 562-565.
- Xiang, C., Miao, Z., and Lam, E. 1997. DNA-binding properties, genomic organization and expression pattern of TGA6, a new member of the TGA family of bZIP transcription factors in *Arabidopsis thaliana*. *Plant Mol. Biol.*, **34**: 403-415.
- Xiang, C., Miao, Z.H., and Lam, E. 1996. Coordinated activation of as-1-type elements and a tobacco glutathione S-transferase gene by auxins, salicylic acid, methyl-jasmonate and hydrogen peroxide. *Plant Mol. Biol.*, **32**: 415-426.
- Xu, Y., Chang, P., Liu, D., Narasimhan, M., Raghothama, K., Hasegawa, P., and R, B. 1994. Plant Defense Genes Are Synergistically Induced by Ethylene and Methyl Jasmonate. *Plant Cell*, **6**: 1077-1085.
- Yalpani, N., Enyedi, A.J., J, L., and Raskin, I. 1994. Ultraviolet light and ozone stimulate accumulation of salicylic acid, pathogenesis related proteins and virus resistance in tobacco. *Planta*, **193**: 372-376.
- Yalpani, N., Silverman, P., Wilson, T., Kleier, D.A., and Raskin, I. 1991. Salicylic Acid Is a Systemic Signal and an Inducer of Pathogenesis-Related Proteins in Virus-Infected Tobacco. *Plant Cell*, **3**: 809-818.
- Yamazaki, D., Motohashi, K., Kasama, T., Hara, Y., and Hisabori, T. 2004. Target Proteins of the Cytosolic Thioredoxins in *Arabidopsis thaliana*. *Plant Cell Physiol.*, **45**: 18-27.
- Yang, Y., Qi, M., and Mei, C. 2004. Endogenous salicylic acid protects rice plants from oxidative damage caused by aging as well as biotic and abiotic stress. *Plant J.*, **40**: 909-919.
- Yoshihara, Y., Kiyosue, T., Nakashima, K., Yamaguchi-Shinozaki, K., and K., S. 1997. Regulation of levels of proline as an osmolyte in plants under water stress. *Plant Cell Physiol.*, **38**: 1095-1102.
- Yu, E.Y., Kim, S.E., Kim, J.H., Ko, J.H., Cho, M.H., and Chung, I.K. 2000. Sequence-specific DNA Recognition by the Myb-like Domain of Plant Telomeric Protein RTBP1. *J. Biol. Chem.*, **275**: 24208-24214.
- Zhang, Y., Fan, W., Kinkema, M., Li, X., and Dong, X. 1999. Interaction of NPR1 with basic leucine zipper protein transcription factors that bind sequences required for salicylic acid induction of the PR-1 gene. *Proc. Natl. Acad. Sci. USA.*, **96**: 6523-6528.
- Zhang, Y., Tessaro, M.J., Lassner, M., and Li, X. 2003. Knockout Analysis of *Arabidopsis* Transcription Factors TGA2, TGA5, and TGA6 Reveals Their Redundant and Essential Roles in Systemic Acquired Resistance. *Plant Cell*, **15**: 2647-2653.
- Zhao, J., Davis, L.C., and Verpoorte, R. 2005. Elicitor signal transduction leading to production of plant secondary metabolites. *Biotech. Advan.*, **23**: 283-333.
- Zhou, J.M., Trifa, Y., Silva, H., Pontier, D., Lam, E., Shah, J., and Klessig, D.F. 2000. NPR1 differentially interacts with members of the TGA/OBF family of transcription factors that bind an element of the PR-1 gene required for induction by salicylic acid. *Mol. Plant Microbe Interact.*, **13**: 191-202.
- Zhou, N., Tootle, T.L., Tsui, F., Klessig, D.F., and Glazebrook, J. 1998. PAD4 functions upstream from salicylic acid to control defense responses in *Arabidopsis*. *Plant Cell*, **10**: 1021-1030.

Chapter 9

THE INTERPLAY BETWEEN SALICYLIC ACID AND REACTIVE OXYGEN SPECIES DURING CELL DEATH IN PLANTS

J.F. DAT¹, N. CAPELLI¹, F. VAN BREUSEGEM²

¹Laboratoire de Biologie Environnementale (EA 3154 MRT, UC INRA), Université de Franche-Comté, UFR Sciences et Techniques, Place Leclerc, F-25030 Besançon Cedex, France ; ²Department of Plant Systems Biology, Ghent University, VIB, Technologie Park 927, B-9052 Gent, Belgium.

Abstract: There is increasing interest in the interactive role between salicylic acid (SA), reactive oxygen species (ROS) and other plant signalling molecules in regulating cell death in plants. Initial evidence suggested that SA was a potent inhibitor of heme-containing enzymes such as catalase and ascorbate peroxidase, thus capable of stimulating ROS accumulation during various biotic and abiotic stress conditions. However, others suggested that the mode of action of SA may in fact be related to its ability to prime the defense response, by increasing the levels of various defense compounds. SA was also proposed as both a potent inducer of the NADPH-oxidase and an inhibitor of the alternative oxidase, thus capable of indirect regulation of the redox status of plant cells. This role in regulating the redox status has been linked to the programmed cell death (PCD) typically observed during the hypersensitive response (HR) but also during development (leaf laces, tracheary elements, root cap, germination...) and some abiotic stress responses (salt and heavy metal stress, anoxia). Today, an interplay between SA, ROS and other signalling molecules is proposed in the regulation of PCD in plants. The present chapter reviews the evidence that has accumulated on the interactive nature of the relationship between ROS and SA and addresses this love-hate relationship in view of cell death in plants.

Key words: Salicylic acid, reactive oxygen species, nitric oxide, programmed cell death, jasmonic acid, ethylene

1. INTRODUCTION

Salicylic acid (SA) belongs to a diverse group of plant phenolic compounds. It was initially proposed as an important signal molecule during plant-pathogen interactions, a chemical defence against microbes, and having allelopathic effects on germination and growth of neighbouring plants (Malamy and Klessig, 1992; Raskin, 1992). Since then, numerous new roles have been proposed for SA. These include, mediation of the response to high temperature stress (Dat *et al.*, 1998a; Dat *et al.*, 1998b; Lopez-Delgado *et al.*, 1998; Dat *et al.*, 2000a; He *et al.*, 2005; Larkindale *et al.*, 2005), chilling (Janda *et al.*, 1999; Senaratna *et al.*, 2000), salt and osmotic stress (Mikolajczyk *et al.*, 2000; Borsani *et al.*, 2001; Molina *et al.*, 2002) ozone and ultraviolet light exposure (Yalpani *et al.*, 1994; Sharma *et al.*, 1996; Rao and Davies, 1999). However, it is now obvious that the role of SA during plant biotic and abiotic stress responses is coupled to the production of reactive oxygen species (ROS). In fact, most stress situations, if not all, alter cellular redox homeostasis (Dat *et al.*, 2000b; Mittler, 2002). As a result, it is not surprising that SA, a molecule implicated in an increasing number of plant stress responses, interacts with ROS in a signalling network still being elucidated.

One of the most studied responses involving both ROS and SA is the hypersensitive response (HR) typically observed during plant-pathogen incompatible interactions. During the early stages of plant-pathogen recognition, ROS are produced rapidly and transiently at the site of infection. This so-called oxidative burst has been proposed to serve not only as a potential cell wall strengthening and antimicrobial defence mechanism, but also as a necessary signalling component for the induction of the appropriate defence responses. Following the initial rise in ROS species, SA often accumulates, preceding a secondary burst typically observed during incompatible interactions (Draper, 1997). In many cases studied to date, both ROS and SA seem necessary for HR-cell death. Furthermore, other studied examples of the interaction between ROS and SA during abiotic stress responses (i.e. ozone, UV) also suggest an important role for both, during cell death events. The focus of this chapter is to review the role(s) and mechanism(s) of ROS and SA interplay during cell death in plants.

2. The nature of the relationship between salicylic acid and reactive oxygen species

2.1 Is salicylic acid necessary during plant-pathogen interactions?

The story of the relationship between salicylic acid (SA) and reactive oxygen species (ROS) goes back more than a decade. In the early 1980's, a series of experiments triggered a major surge in plant-pathogen research with the identification of SA as a major player in this interaction. Although not always conclusive, these early experiments had the merit to focus attention on a major new area of research which has today allowed great progress in the understanding of plant-pathogen interactions. One of the first experiments was the demonstration that acetylacetic acid (ASA) application protected tobacco plants from infection by tobacco mosaic virus (TMV) (White 1979). Subsequent experiments demonstrated that SA was also able of inducing TMV protection in tobacco as well as inducing the expression of pathogenesis-related (PR) genes in tobacco and *Arabidopsis* (Antoniw and White, 1980; Ward *et al.*, 1991; Uknes *et al.*, 1993; Yalpani *et al.*, 1991; Conrath *et al.*, 1995; Ryan and Jagendorf, 1995). Similar results were obtained in cucumber inoculated with *Colletrichum lagenarium* (Siegrist *et al.*, 1994) and, SA was shown to inhibit the systemic accumulation of proteinase inhibitor proteins following wounding (Doherty *et al.*, 1988). These data were corroborated by emerging evidence that SA accumulation correlated with tobacco response to TMV (Malamy *et al.*, 1990; Malamy and Klessig, 1992) and systemic acquired resistance (SAR) in cucumber (Métraux *et al.*, 1990; Rasmussen *et al.*, 1991) and *Arabidopsis* (Uknes *et al.*, 1993; Delaney 1997). Gaffney *et al.*(1993) demonstrated that transgenic plants, expressing a bacterial salicylate hydroxylase (*NahG*) gene, failed not only to accumulate SA following pathogen attack, but were also unable to activate defence responses. Although it was then clear that some defence responses were SA-dependent, under other circumstances SA seemed not required. For instance, transgenic tobacco plants expressing a pokeweed antiviral protein exhibited resistance to a broad range of viruses in the absence of SA accumulation (Smirnov *et al.*, 1997). Furthermore, SA was not involved in the early induction of PR genes in tobacco in response to *Erwinia carotovora* (Vidal *et al.*, 1997). Consequently, SA is probably not required during some plant-pathogen responses.

2.2 Mechanism(s) of action of salicylic acid during plant-pathogen interactions

Once SA was identified as a crucial player in some pathogenic responses, several research groups went on a quest to identify the mechanism(s) of action of SA. Some of the early functional studies suggested that SA was a signalling molecule capable of inhibiting catalase activity (Chen *et al.*, 1993a; Sanchez-Casas and Klessig, 1994; Conrath *et al.*, 1995). It was thus postulated that SA increased cellular H₂O₂ through its inhibitory effect on catalase. Hence, H₂O₂ was proposed as a possible mediator of plant-pathogen defence responses and more specifically involved in signalling during systemic acquired resistance (SAR; Chen and Klessig 1991; Chen *et al.*, 1993a; Chen *et al.*, 1993b). Although the proposition that H₂O₂ may serve as a secondary messenger for SA signalling was an attracting hypothesis, several other studies failed to demonstrate a similar SA-inhibition of catalase activity in tobacco (Willekens *et al.*, 1994; Bi *et al.*, 1995), *Arabidopsis thaliana* (Summermatter *et al.*, 1995; Rao *et al.*, 1997), soybean (Tenhaken and Rübél, 1997) and maize (Guan and Scandalios, 1995). The role of H₂O₂ as a secondary messenger of SA- signalling was thus questioned. Furthermore, H₂O₂ infiltration in tobacco leaves induced benzoic acid 2-hydroxylase (BA2H) and SA accumulation (Leon *et al.*, 1995), suggesting that H₂O₂ was not downstream in the SA signalling pathway but rather upstream of SA biosynthesis. The debate was later put to rest with a model reconciling these various results, in which a feedback cycle between SA and H₂O₂ amplifies the SA/H₂O₂ signal (Van Camp *et al.*, 1998). Since then, the model has been improved with the addition of other players, notably NO, ethylene and jasmonic acid (Overmyer *et al.*, 2000; Delledonne, 2005), but the basic amplification SA/ROS loop still holds (Figure 1).

2.3 Salicylic acid and reactive oxygen species during abiotic stress

Reactive oxygen species accumulation is a common feature of abiotic stress responses (Dat *et al.*, 2000b; Mittler, 2002; Mittler *et al.*, 2004). As a result, there exist several examples of SA and ROS interplay during abiotic stress situations, the most studied being exposure to either ultraviolet light (UV) or ozone. The rapid and transient production of ROS during these stress conditions is analogous to the “oxidative burst” commonly observed during plant-pathogen interactions but also to that reported in mammalian macrophage and neutrophils during pathogen invasion (Langerbartels *et al.*, 2002). During ozone exposure, ROS are believed to be generated following

ozone entry through the stomata and its conversion in the leaf apoplast (Pellinen *et al.*, 1999; Rao *et al.*, 2000). In fact, necrotic lesions in ozone-exposed leaves were long considered a consequence of phytotoxic ROS accumulation. In recent times however, a new model has emerged in which ozone-mediated cell death is very similar to HR-cell death. Ozone may in fact act as an elicitor of plant-pathogen HR reactions (Sandermann *et al.*, 1998; Rao *et al.*, 2000; Kangasjarvi *et al.*, 2005). This proposition is supported by various observations: i) ozone induces a biphasic ROS burst in the sensitive Bel W3 tobacco cultivar, not in resistant varieties, ii) the oxidative burst precedes and spatially correlates with cell death and, iii) lesion development is greatly reduced by the application of diphenylene iodonium (DPI), a flavin oxidase inhibitor (Shraudner *et al.*, 1998; Pellinen *et al.*, 1999; Rao and Davis, 1999; Overmyer *et al.*, 2000). In addition, SA accumulates within a few hours in both ozone-sensitive tobacco and *Arabidopsis* plants exposed to ozone and UV (Yalpani *et al.*, 1994; Orvar *et al.*, 1997; Sharma and Davis, 1997; Rao and Davis, 1999) and, exogenous SA application increases the sensitivity of ozone tolerant genotypes to ozone treatment (Rao *et al.*, 2000). Further evidence was provided with transgenic *NahG* plants and SA-insensitive *npr1 Arabidopsis* mutants which failed to develop lesions during ozone exposure (Orvar *et al.*, 1997; Rao and Davis 1999; Overmyer *et al.*, 2005) thus substantiating a role for SA during ozone-induced lesions formation. In addition, *Arabidopsis eto1* and *eto3 mutants*, ethylene overproducers, constitutively accumulate high SA levels and exhibit a rapid increase in free SA prior to lesion formation in response to ozone fumigation (Rao *et al.*, 2002). It is, therefore, clear that during many biotic and abiotic stress situations an interaction between SA and ROS is crucial for the development of an appropriate response.

It is important to note, however, that recent comparison of transcriptomes during ozone exposure reveals that approximately one-third of the responsive transcripts are ozone specific, thus suggesting important SA-independent redox signalling pathways during this stress (Baier *et al.*, 2005). Furthermore, in rice, which contains much higher basal levels of free SA (at least 10 times more than infected tobacco or *Arabidopsis* plants), SA does not appear to be an effective signal molecule during disease responses (Yang *et al.*, 2004). SA-deficient transgenic rice have higher ROS levels and reduced antioxidant capacity, they also exhibit spontaneous lesion formation in an age- and light-dependent manner. Symptom development was in fact suppressed by exogenous application of a SA analog, benzothiadiazole. Although unexpected, these results may be explained by the fact that in plants SA may directly function as an antioxidant as reported for animals (Castagne *et al.*, 1999). Indeed, SA may scavenge hydroxyl radicals and thus protect plants against catalase inactivation by H₂O₂ (Durner and Klessig,

1996). Hence, in rice for instance, SA may play a critical role in modulating the cell redox balance, hence protecting the plant against oxidative damage (Yang *et al.*, 2004).

3. CELL DEATH PROCESSES IN PLANTS

3.1 The various forms of cell death in plants

Paradoxically, death is an integral part of life. Cell fate (proliferation, differentiation or programmed cell death) is crucial during various stages of a plant's life cycle (Kadota *et al.*, 2004). In fact, the sacrifice of individual or specific groups of cells is required for proper plant development. Although much is known on programmed cell death (PCD) in animal cells, much less is known on the molecular regulators of PCD in plants. Generally speaking however, cell death processes seem rather well conserved in evolution and, signalling cell death pathways have been identified in various organisms, from unicellular to multicellular mammalian organisms.

Initially, cell death events were divided into two categories: apoptotic or necrotic. Necrosis is accidental, and factors that lead to this cell death are mostly extrinsic such as accumulation of phytotoxic molecules following a traumatic stress event. Thus, cell death through necrosis is considered passive, indiscriminant and often follows irreversible injury. Necrosis is characterised by a progressive loss of membrane integrity, an influx of Ca^{2+} and other ions which results in swelling of the cytoplasm and release of cellular constituents (Pennell and Lamb, 1997). On the other hand, apoptosis refers to the characteristic morphological changes that occur during genetically controlled animal cell death (Bidle and Falhowski, 2004). These include: i) cytoplasmic and nuclear shrinkage, ii) chromatin condensation and fragmentation and iii) an orderly energy-dependent enzymatic breakdown of DNA into characteristic fragments. However, over the last decade, it has become clear that more than two types of cell death exist and that apoptosis *per se* does not take place in plants. Rather various forms of active cell death are observed and nowadays, many authors use the term programmed cell death to describe any plant cell death process involving energy and genetic processing (Dangl and Jones, 2001; Lam *et al.*, 2001). Generally speaking, PCD can be defined as an elementary process of life that maintains tissue and organ homeostasis in concert with proliferation, growth and differentiation (Böhm and Schild, 2003).

PCD can occur during many situations and it has been described during both biotic and abiotic stress conditions (Pennell and Lamb 1997). In plants,

PCD events have been best described during plant-pathogen interactions as the basis for the hypersensitive response (HR) typical of incompatible interactions (Jones and Dangl, 1996; Greenberg, 1997; Pennell and Lamb, 1997; Heath, 2000). However, some abiotic stress situations are also capable of inducing such cell death events and PCD has been described for instance during hypoxia stress (He *et al.*, 1994; Gunawardena *et al.*, 2001a; 2001b), chilling, heat, mechanical stress (Balk *et al.*, 1999) and, ozone (Langebartels *et al.*, 2002) among others. Finally, PCD events have been observed during developmental events such as formation of tracheary elements (Fukuda, 2000; Kuriyama and Fukuda, 2002), aerenchyma formation (He *et al.*, 1996), endosperm development (Young and Gallie, 2000), seed development and germination (Souter and Lindsey, 2000), floral abortion (Rubenstein, 2000), sex determination, root cap cells, flower and leaf senescence (Thomas *et al.*, 2003; Gunawardena *et al.*, 2004) and, hybrid lethality (Frank and Barr 2003; Masuda *et al.*, 2003).

Programmed cell death is thus essential for allowing proper growth and development of many eukaryotes organisms, including plants. The cell death process is not an end in itself as it often drives the living towards another state of life. In plants, developmental changes are marked by specific cell death processes (Gunawardena *et al.*, 2004), however, the question remains, do common signalling components exist between these plant PCD events and if so what are they?

4. THE INEVITABLE ROLE OF REACTIVE OXYGEN SPECIES DURING CELL DEATH IN PLANTS

4.1 Evolution and the inevitable production of reactive oxygen species

The importance of ROS homeostasis in the regulation of plant growth and development lies in the premise of their inevitable production during aerobic metabolism. Back 3.5 billion years, the earliest known life forms, consisting of small simple cells, had emerged. These early life forms drew their energy from molecules in the surrounding environment, notably through reactions of fermentation. The atmosphere then consisted primarily of gases such as nitrogen, carbon dioxide, water vapour, and molecules of gases such as ammonia, hydrogen sulphide and methane. Free O₂ was absent. As the earth crust cooled and stabilized, new compounds are believed to have been formed and droplets of organic molecules

accumulated in the oceans. These organic substances served as the earliest sources of energy and, primitive cells or groups of aggregated cells used this abundant source for energy. As they evolved, these heterotrophic organisms depleted this energy resource and, consequently competition favoured autotrophic cells that had acquired the ability to make their own energy rich molecules from non-organic molecules. The most thriving of all being those capable of converting the sun rays into chemical energy through a complex pigment system. As photosynthetic organisms increased in number, their impact drastically changed the chemical nature of the earth atmosphere. One of the most successful evolutions of photosynthetic organisms was the splitting of water molecules and the release of oxygen. Thereon, almost all life forms based their energy requiring processes on respiration and photosynthesis. As a result, production of ROS in cells became a primer for life, and O₂ became one of the more likely electron acceptor to electrons leaked by over-energised transport chains. Therefore, the production of ROS is intimately linked to life under aerobic conditions and organisms have had to evolve efficient scavenging systems to control ROS production (Noctor and Foyer, 1998; Dat *et al.*, 2000b; Mittler, 2002; Mittler *et al.*, 2004; Foyer and Noctor 2005). Unlike animals, plants are incapable of escaping environmental pressure and accordingly they have a high potential for ROS production. In fact a wide range of stresses may promote ROS production. Because these are extremely reactive, ROS may oxidise biological molecules such as DNA, proteins and lipids.

4.2 Sources of reactive oxygen species during stress conditions

Mitochondria are the main source of ROS in animal cells, however, in plants the chloroplast is the most likely source of ROS under most of the stress conditions. Almost any change in the environment (i.e. drought, light, chilling, pollutants etc.) will result in increased chloroplastic ROS production (Dat *et al.*, 2000b; Mittler, 2002). As a result, chloroplasts have been proposed as potential sensors of environmental changes and chloroplast-derived redox signals may directly regulate gene expression and acclimatory processes (Karpinski *et al.*, 2003; Laloi *et al.*, 2004). The chloroplast is thus one of the most important organelles during abiotic stress responses. ROS may also be produced in the peroxisomes during photoinhibitory conditions.

In contrast, during biotic stress situations, the main source of ROS production is not the chloroplast. Interestingly however, it was recently noted that many experiments on the establishment of plant-pathogen defence responses were undertaken under low light conditions (Karpinski *et al.*,

2003) and there are also several reports of light-dependent pathogen resistance in plants (Montillet *et al.*, 2005). As a result, the importance of chloroplast-derived ROS production has probably been overlooked during many biotic stress responses.

To date, however, incompatible plant-pathogen interactions are typified by a biphasic oxidative burst (Doke, 1997; Draper, 1997). The production of ROS towards the apoplast during this event is assumed to originate in part from an NADPH-oxidase complex very similar to that used by phagocytes during the respiratory burst (Torres and Dangl, 2005). The first plant NADPH-oxidase gene was related to the *gp91phox* gene from mammals and isolated from rice, *OsrbohA* (Groom *et al.*, 1996). Others have since been identified in various plant species (Keller *et al.*, 1998; Torres *et al.*, 1998; Simon-Plas *et al.*, 2002; Yoshioka *et al.*, 2003). Recent studies using *Rboh* mutants and antisense lines helped to demonstrate the essential role of the NADPH-oxidase complex in producing the oxidative burst during incompatible plant-pathogen interactions (Simon-Plas *et al.*, 2002; Torres *et al.*, 2002; Kwak *et al.*, 2003; Yoshioka *et al.*, 2003). However, other sources of ROS have also been proposed during plant-pathogen interactions, these include amine oxidases and peroxydases among others (Bolwell, 1999). To date, therefore, the source of ROS during various stress conditions is rather well established, though there is still no definite consensus on the exact role(s) played by ROS during these events.

4.3 Reactive oxygen species signalling in plants

Reactive oxygen species have long been considered important signalling molecules and key regulators of PCD in various organisms (Korsmeyer *et al.*, 1995; Jabs, 1999; Haddad, 2004; Hilderman, 2004). In yeast, low H₂O₂ concentrations or depletion of intracellular glutathione can induce apoptosis (Samuilov *et al.*, 2000). In plants, a role for ROS as signalling molecules during stress responses has also been proposed. In fact, there has been great progress since the early perception that ROS were only toxic by-products of metabolism. ROS may not only be the lethal molecules produced during environmental constraints but also active partners in various signalling networks. It is now generally accepted that alterations in ROS homeostasis are the key modulators to various cellular processes (Dat *et al.*, 2000b; Hancock *et al.*, 2001; Overmyer *et al.*, 2003; Mittler *et al.*, 2004). Since the early experiments demonstrating that H₂O₂ could cross biological membranes (Levine *et al.*, 1994), H₂O₂ has been shown to be able to travel through water channels (Henzler and Steudle, 2000) and oxidise proteins some distance from its production site (Scandalios 1997). In addition to these exciting findings several research groups have validated the role of

ROS in regulating gene expression during plant-pathogen interactions (Alvarez *et al.*, 1998; Hancock *et al.*, 2002), ozone stress (Langebartels *et al.*, 2002; Overmyer *et al.*, 2003), oxidative stress (Desikan *et al.*, 2001; Vranova *et al.*, 2002; Vandenabeele *et al.*, 2003), and high light (Karpinski *et al.*, 1999; Vandenabeele *et al.*, 2004; Vanderauwera *et al.*, 2005). Changes in ROS homeostasis have also been seriously considered key mediators involved during plant PCD (Desikan *et al.*, 1999; Solomon *et al.*, 1999; Bethke and Jones, 2001; Dat *et al.*, 2003). In fact, ROS may play crucial roles both as initiators and downstream effectors of cell death in plants.

4.4 Reactive oxygen species signalling during cell death

If the accumulation of ROS overwhelms the antioxidant machinery and oxidants accumulate to phytotoxic levels, cell death will occur in the form of necrosis (Figure 1). In fact, most abiotic stress conditions may lead to ROS hyper-accumulation (Dat *et al.*, 2000b). Thus, the fact that ROS can directly kill a cell by accumulating at phytotoxic levels is very much similar to what is observed during necrosis in animals (Bhatia, 2004). ROS-dependent necrosis has been observed following the exogenous application of H₂O₂ in plant cell systems (O'Brien *et al.*, 1998) or following high ROS accumulation during various abiotic stress situations (Dat *et al.*, 2000b). In fact, there is increasing evidence that the concentration and duration of ROS exposure will either lead to necrosis or PCD (McCabe *et al.*, 1997; McCabe and Leaver, 2000; Houot *et al.*, 2001; Casolo *et al.*, 2005).

Early indication that ROS were also likely involved during PCD was observed when H₂O₂ treatment of soybean cells induced cell death and that H₂O₂ from the oxidative burst regulated HR-cell death (Levine *et al.*, 1994). Later experiments demonstrating that H₂O₂-dependent cell death was blocked by cycloheximide, a protein synthesis inhibitor, confirmed these findings (Solomon *et al.*, 1999). More recent experiments with transgenic Cat1AS tobacco plants, deficient in catalase, confirmed that H₂O₂-dependent active cell death events could be blocked by cycloheximide as well as other signalling inhibitors (Dat *et al.*, 2003). Thus, H₂O₂ was proposed as an initiator of active cell death and/or PCD. In effect, H₂O₂-dependent signalling during PCD has been demonstrated in numerous models (Alvarez *et al.*, 1998; Orozco-Cardenas *et al.*, 2001; Pellinen *et al.*, 2002; Dat *et al.*, 2003; Vandenabeele *et al.*, 2004). H₂O₂ clearly participates in the propagation of pathogen- and ozone-dependent PCD (Grant and Loak 2000; Langebartels *et al.*, 2002; Overmyer *et al.*, 2003). H₂O₂ is also implicated in GA-dependent PCD events in aleurone protoplasts (Bethke *et al.*, 1999; Bethke and Jones 2001). Transgenic tobacco and *Arabidopsis* plants with reduced antioxidant capacity (as a result of antisense suppression of catalase

or ascorbate peroxidase), accumulate high H₂O₂ levels and spontaneously develop necrotic lesions when exposed to H₂O₂ producing conditions (Takahashi *et al.*, 1997; Chammongpol *et al.*, 1998; Mittler *et al.*, 1999; Rizhsky *et al.*, 2002; Dat *et al.*, 2003; Vandenabeele *et al.*, 2004). The development of lesions is spatially correlated with high endogenous accumulation of H₂O₂. Further experiments demonstrated that in fact, a transient accumulation of H₂O₂ was sufficient to induce an active cell death program (Dat *et al.*, 2001; Dat *et al.*, 2003; Vandenabeele *et al.*, 2003). The transient H₂O₂ pulse induced an active cell death program showing a similar fatty acid signature to that obtained following cryptogein-triggered PCD (Montillet *et al.*, 2005). In contrast, when the plants were exposed to longer periods of H₂O₂ accumulation, the H₂O₂-cell death event showed characteristics of necrosis and was very similar to that observed under HL-dependent pathogen PCD (Dat *et al.*, 2003; Montillet *et al.*, 2005). In rice, the overexpression of *OsRac1* (a rice homolog of mammalian Rac GTPase) induces cell death in transgenic cell cultures, which was correlated with high H₂O₂ accumulation (Kawasaki *et al.*, 1999; Ono *et al.*, 2001).

In other studies, superoxide anion rather than H₂O₂ was identified as the key player in PCD events and lesion formation. For instance, the *lsd1* mutants of *Arabidopsis*, which accumulates high levels of superoxide anion, also developed spontaneous lesions (Jabs *et al.*, 1996). We can, therefore, conclude from these studies that ROS can induce both necrosis and PCD, depending on the level of ROS accumulation in the cell and that the nature of the ROS species involved.

However, it must also be noted that there are examples in which ROS are neither sufficient nor necessary for PCD. For instance, work on tobacco with a mutated *Pseudomonas* strain indicated that although H₂O₂ was necessary for HR-cell death, it was not sufficient (Glazener *et al.*, 1996). Under dark conditions, tobacco cell death induction by the elicitor cryptogein was independent of H₂O₂ (Montillet *et al.*, 2005). Finally, the PCD process that takes place during TE differentiation is independent of ROS species (Fukuda 2000). Indeed, when ROS species were monitored in TE-inductive cell cultures, results indicated that the H₂O₂ increase in TE-inductive cells was less than in TE non-inductive cells. Furthermore, addition of dephenylene iodonium (DPI), a flavin-containing oxidase inhibitor, failed to inhibit TE PCD (Groover *et al.*, 1997). This further reinforces the idea that there exist multiple PCD types in plants, some require ROS while others do not.

4.5 Importance of mitochondria during PCD

In animals, the mitochondria play a central role in PCD by releasing cytochrome *c* and activating caspases. The mitochondria participate in the

cytoplasmic control and intervene in the effector phase of PCD. Alterations in mitochondrial permeability and transition linked to disruption of membrane potential precede PCD-driven nuclear and plasma membrane changes (Petit *et al.*, 1996). In fact, there is a growing belief that the intracellular redox status is critical in mitochondria-dependent cell death in animals (Kowaltowski *et al.*, 2001). In plants, mitochondria have recently been revealed as key integrators of PCD (Jones, 2000; Swidzinski *et al.*, 2002; Lam, 2004; Swidzinski *et al.*, 2004). Transgenic tobacco cells lacking AOX showed enhanced susceptibility to various cell death inducers, including H₂O₂ and SA (Robson and Vanlerberghe 2002; Vanlerberghe *et al.*, 2002). Furthermore, SA and H₂O₂ driven cell death occurs through a mitochondria-dependent pathway (Moore *et al.*, 2002). There is, therefore, increasing evidence for mitochondria to play some role in plant PCD, however, convincing evidence is still lacking on how they may participate during cell death.

5. THE IMPORTANCE OF SALICYLIC ACID DURING CELL DEATH IN PLANTS

5.1 Salicylic acid and plant-pathogen interactions

Salicylic acid has long been recognised as a key endogenous signal, involved in plant defence responses. When a pathogen carrying the avirulence (*avr*) gene is recognised either directly or indirectly by a plant carrying the cognate resistance (*R*) gene, ensues the activation of defence responses that restrict pathogen growth and spreading in both infected and non-infected tissues. These events are qualified as local (LAR) and systemic acquired resistance (SAR) and, in most cases, they are accompanied by the development of lesions around the site of infection, as a result of cell suicide. This typical process termed the hypersensitive response (HR) is believed to be mediated in part by SA. In fact, although SA has long been recognised as a key molecule in defence responses, its exact function in HR-cell death is still rather poorly understood (Hoeberichts and Woltering, 2002).

5.2 Importance of salicylic acid during the hypersensitive-dependent PCD

Following the pathogen infection, endogenous levels of SA and its conjugate (SA-glucoside) significantly increase in tobacco, *Arabidopsis* and

cucumber (Malamy *et al.*, 1990; Métraux *et al.*, 1990; Rasmussen *et al.*, 1991). The rise in SA levels precedes the induction of pathogenesis-related proteins and activates LAR and SAR (Ryals, 1996). Early results obtained with transgenic tobacco expressing the bacterial *NahG* gene, encoding an SA-degrading enzyme, demonstrated the crucial role played by SA in mediating both LAR and SAR (Gaffney *et al.*, 1993; Delaney *et al.*, 1994). These results were further supported by the characterization of two SA-deficient *Arabidopsis* mutants *sid2* and *eds5* which show enhanced susceptibility to several bacterial pathogens, although in most cases, their susceptibility was not as pronounced as in *NahG* transgenic plants (Rogers and Ausubel, 1997; Nawrath and Métraux, 1999). The analysis of two other *Arabidopsis* mutants (*acd* and *lsd*) that spontaneously activate PCD also supported the importance of SA in cell death processes as both have constitutively high SA levels (Rate *et al.*, 1999; Brodersen *et al.*, 2002). Moreover, the fact that addition of SA to either soybean suspension cultures or *Arabidopsis lsd1* mutants accelerated cell death is further evidence for a modulating role of SA during PCD (Dietrich *et al.*, 1994; Shirasu *et al.*, 1997). Exogenous application of SA in *acd11/eds5-1 Arabidopsis* mutants also accelerated PCD, thus demonstrating a potentiating effect of SA on PCD (Brodersen *et al.*, 2005). However, it must be noted, that although several mutants retain the spontaneous lesion formation in the *NahG* background, many others have delayed or suppressed cell death symptoms. It was thus suggested that SA accumulation should be placed both upstream and downstream of PCD (Hoeberichts and Woltering, 2002), reinforcing the SA feedback loop amplification scenario.

A question, however, remains regarding the biosynthetic pathway of SA during plant defence reactions. Early dissection of the SA pathway suggested that SA could be synthesized from cinnamic acid through two pathways. Once phenylalanine has been converted into trans-cinnamic acid by phenylalanine ammonia lyase (PAL), trans-cinnamic acid could then be either hydroxylated to form o-coumaric acid before oxidation of the side chain or the side chain is shortened to give benzoic acid (BA; Sticher *et al.*, 1997; Métraux, 2002). At least in tobacco and cucumber plants, SA is thought to be exclusively derived via BA through the conversion of trans-cinnamic acid (Ward *et al.*, 1991; Silverman *et al.*, 1995; Sticher *et al.*, 1997; Chong *et al.*, 2001). In fact, SA is metabolised by a combination of glucosylation and decarboxylation with 2-O-glucoside as a major primary metabolite in many species (Tanaka *et al.*, 1990; Yalpani *et al.*, 1992; Enyedi *et al.*, 1992; Malamy and Klessig, 1992; Edwards, 1994). More recently, the SA biosynthetic pathway leading to potentiation of cell death has been proposed to be derived through isochorismate synthesised by SID2 (Brodersen *et al.*, 2005), though not excluding the participation of PAL-

mediated SA biosynthesis during PCD events in tobacco and *Arabidopsis* (Mauch-Mani and Slusarenko, 1996; Ribnicky *et al.*, 1998; Wildermuth *et al.*, 2001).

6. INTERACTIVE NATURE OF SA AND ROS DURING PLANT CELL DEATH

6.1 SA and ROS interplay during PCD

There is an increasing amount of data that point to a cellular relation between ROS and SA biosynthesis or with receptor proteins. The recent cloning of the salicylic acid-binding protein 3 (SABP3), a chloroplast-localised protein involved in the HR, suggests a close interplay between SA and ROS in the chloroplast (Slaymaker *et al.*, 2002). Furthermore, mutations in either a chloroplast-located isochorismate synthase (ICS) gene in *Arabidopsis* (Wildermuth *et al.*, 2001), a plastid located stearyl acyl (ACP) carrier protein (Kachroo *et al.*, 2001), or a red chlorophyll catabolite reductase (ACD2) gene (Mach *et al.*, 2001), all alter SA synthesis and plant defence signalling. Thus, it is clear that the localization of some precursors of SA synthesis in the chloroplast, the main source of ROS in plants, can only support the interactive nature of signalling derivatives.

Taken together, the interactive relationship between SA and ROS during cell death is rather intriguing. In fact, several recent results clearly demonstrate that what was thought as a rather simple synergistic relationship is in fact much more complex. Originally, SA was proposed as a catalase or ascorbate peroxidase inhibitor, as discussed above. However, these suggestions were soon re-evaluated with the demonstration that the inhibition of catalase by SA was not sufficient to explain the high SA-dependent ROS accumulation in plant cells. In the presence of diphenylene iodonium (DPI), elicitor-dependent SA accumulation in tobacco cells is prevented (Dorey *et al.*, 1999). Furthermore, this abolishment of SA accumulation was recently shown to be accompanied by a higher level of conjugated BA (Chong *et al.*, 2001). These data, in combination with the fact that H₂O₂ can activate SA accumulation through the stimulation of BA2H (Leon *et al.*, 1995), show that ROS are necessary for the conversion of BA to SA. On the other hand, SA can also potentiate ROS production and enhance the damage caused by ROS.

Indeed, when comparing wild type and *NahG Arabidopsis* plants Borsani *et al.*, (2001) found that the necrosis damage on wild type plants grown on mannitol containing media was not observed in *NahG* plants. The lack of

damage in SA-deficient lines suggested that SA could potentiate the generation of ROS in photosynthetic tissues during salt and osmotic stress. These observations are further supported by the fact that exposure to a ROS generating herbicide, methyl viologen (MV), produced necrotic lesions only on wild type but not on *NahG* plants (Borsani *et al.*, 2001).

As a result, SA action was proposed to be driven by its capacity to synergistically enhance ROS accumulation. This hypothesis, although probably not complete, had the merit to set forward a new line of thinking where the interaction between these various molecules was not linear but rather multi-complex. Combined with the recent proposition that H₂O₂ can synergistically enhance its own production through the activation of NADPH-oxidase complexes (Dat *et al.*, 2003; Mittler *et al.*, 2004), the new proposed ROS-SA-ROS network may start to look more like a feedback / feedforward relay depending on various other factors (Figure 1).

7. OTHER MEMBERS OF THE SA/ROS CELL DEATH PATHWAY

The SA signalling pathway during plant defence responses can not be seen as a static or linear pathway (Shah, 2003). As described above, there are a multitude of intrinsic and extrinsic signals which activate SA synthesis and signalling. In addition, the downstream targets of SA pathway are multiple and include such diverse candidates as protein activity (Dempsey *et al.*, 1999), gene expression and interactive regulation of other plant hormones (Feys and Parker, 2000; Kunkel and Brooks, 2002). Follows a short discussion of other important signalling molecules clearly involved in the regulatory network leading to SA dependent PCD in plants.

7.1 Jasmonic acid antagonises SA action

There is increasing evidence of an interaction between SA and jasmonic acid (JA) in the initiation of PCD. This cross-talk between both signalling pathways has been best characterised after wounding or following attack by herbivores and necrotizing fungal pathogens, both inducing an SA-independent SAR (Nibbe *et al.*, 2002). SA prevents JA accumulation following *Pseudomonas* infection through modulation of NPR1 (Spoel *et al.*, 2003; Dong, 2004). Furthermore, JA signalling inhibits SA-dependent responses in both tomato and *Arabidopsis* (Kloek *et al.*, 2001; Zhao *et al.*, 2003). This antagonist effect of JA signalling on SA-dependent responses was also shown using the COR-insensitive mutants of *Arabidopsis* (*coil*) and tomato (*jar1*) which are defective in JA signalling. COR, the coronatine

toxin of *Pseudomonas syringae*, is a virulence factor involved in lesion formation and bacterial growth (Abramovitch and Martin, 2004). The increased resistance to *Pseudomonas syringae* in both mutants is believed to be mediated through an enhanced SA response (Kloek *et al.*, 2001; Zhao *et al.*, 2003).

An important role for JA has also been dissected during ozone-induced PCD. Ozone treatment not only increases SA but also JA levels in various species (Rao *et al.*, 2000; Koch *et al.*, 2000). In addition, inhibition of cell death was obtained following treatment of O₃-sensitive *Arabidopsis* with methyl jasmonate (Overmyer *et al.*, 2000; Rao and Davis, 2001). When the *rcd1* mutant of *Arabidopsis* is treated with JA, following cell death promoting conditions, the spreading of cell death is halted, thus clearly indicating a key role for JA in cell death containment (Overmyer *et al.*, 2000; 2005). The ozone-dependent cell death in *rcd1* mutants showed some characteristics of PCD such as DNA fragmentation, nuclear shrinkage, and cytosol vesiculation (Overmyer *et al.*, 2005). Interestingly, when double *rcd1/npr1* or *rcd1/NahG* mutants, compromised in SA signalling, were exposed to ozone, the development of lesions was reduced but not completely suppressed. This suggested that the *rcd1* mutant phenotype was both SA-dependent and -independent. When these results are combined with the observation that JA-insensitive or biosynthesis mutants (*jar1*, *coi1* and *fad7/8*) display lesion formation during ozone exposure, one can clearly conclude that JA antagonistically regulates SA-dependent PCD events. Furthermore, the analysis of MAP kinase cascades during the HR has demonstrated that MAPK4 negatively regulates SAR by repressing SA biosynthesis and promoting JA response (Petersen *et al.*, 2000). Hence, JA acts by inhibiting SA signalling and thus it may be an important negative regulator of SA-dependent PCD.

7.2 Ethylene can regulate PCD events

Ethylene has also been clearly identified as a key player in PCD. Its involvement during HR-cell death seems to depend on the nature of the pathogen system, studied. Ethylene is also an important mediator during ozone-mediated PCD. Early correlative experiments demonstrated that in tobacco transgenic Cat1AS plants that accumulate H₂O₂ under photorespiratory conditions, an early accumulation of ethylene preceded a biphasic SA accumulation which temporally preceded the appearance of cell death symptoms (Chamnongpol *et al.*, 1998). A similar temporal correlation between ethylene accumulation and cell death has also been observed in certain plant-pathogen interactions (Wang *et al.*, 2002) and, during ozone exposure of sensitive plants (Overmyer *et al.*, 2000). Further experiments

with ethylene synthesis and perception inhibitors reduced ROS-derived ozone-dependent cell death in both *Arabidopsis* and tomato (Tuomainen *et al.*, 1997; Overmyer *et al.*, 2000; Moeder *et al.*, 2002). NahG expression in the dominant *eto3* mutant rescued the cell death phenotype exhibited by *eto3* plants. These results clearly show that, in *Arabidopsis*, SA and ethylene act in concert for lesion formation and that ozone-induced ethylene production requires SA accumulation (Rao *et al.*, 2002).

Ethylene has also been implicated in other stress-dependent cell death events. For instance, development of aerenchyma (lacunae gas spaces) in the root cortex is one of the most important adaptive responses to soil flooding in many flood tolerant species (Vartapetian and Jackson 1997; Schussler and Longstreth 2000; Chen *et al.*, 2002; Evans 2003; Dat *et al.*, 2004). This ethylene-dependent cell death and lysis occurs behind the root apex in the region of cell expansion and forms continuous gas-filled channels which help oxygen diffusion from shoot to roots (Drew 1997). The lysogenic development of aerenchyma (formed by partial breakdown of the cortex) is characterised by specific targeting of root cortical cells, thus supporting a programmed cell death (Kawai *et al.*, 1998). In *Sagittaria lancifolia* for instance, nuclear changes (clumping of chromatin, fragmentation, disruption of the nuclear membrane), are the earliest events observed following flooding. In addition, ethylene is required for aerenchyma formation in maize (Kende 1993; He *et al.*, 1996; Lorbiecke and Sauter 1999; Drew *et al.*, 2000). Although, SA has never been measured during hypoxia stress in plants, the presence of a mitochondria-dependent PCD, which involves other known signalling intermediates of SA networks, most notably ROS and nitric oxide, may suggest a “hidden” role for SA/ROS/NO during aerenchyma development. Thus, it seems probable that ethylene works in harmony with SA as a positive modulator of PCD in plants.

7.3 Nitric oxide: the new player in the death cascade

Finally at least one more signalling molecule which is clearly involved in PCD can interact with SA during this process. Nitric oxide (NO) is used by mammals to regulate various biological processes of the immune, nervous and vascular systems. NO also serves as a secondary messenger in oxygen sensing in mammalian cells. It is becoming increasingly apparent that NO is a ubiquitous signal in plants where inorganic forms of oxidized nitrogen are the sources of NO formation. Under certain conditions NO can be produced by enzymatic and non-enzymatic reduction of nitrate and nitrite. In animals, NO and ROS combine to induce apoptosis (Curtin *et al.*, 2002). In plants, NO has recently been shown to synergistically act with ROS in HR-cell death (Delledonne *et al.*, 1998), although others have reported a protective effect of

NO during ROS-mediated PCD (Beligni and Lamattina, 1999). It seems, however, that different responses observed are related to a subtle balance between NO and ROS production (Delledonne *et al.*, 2001). Indeed, NO has been shown to regulate cell death processes in plants (Delledonne *et al.*, 1998; Durner *et al.*, 1998; Clarke *et al.*, 2000; Delledonne *et al.*, 2001). NO may also directly interact with SA as SA treatment enhances NO production in soybean (Klepper 1991) and, NO treatment results in a significant accumulation of SA in tobacco leaves (Durner *et al.*, 1998). Moreover, recent results point to a crucial role for SA during NO-mediated SAR (Song and Goodman, 2001). NO may also participate in signalling networks associated with other plant growth regulators. In addition, wounded *Arabidopsis thaliana* leaves accumulate NO in epidermal cells and JA treatment strongly stimulates NO production (Huang *et al.*, 2004; Delledonne, 2005). Spatial accumulation of NO correlates with initiation of cell death in alfalfa roots exposed to hypoxia conditions (Dordas *et al.*, 2003). It may, therefore, be proposed that SA can modulate NO action in a dose-dependent manner similar to that suggested between ROS and NO. Furthermore, SA signalling could act through NO during certain cell death programs whereas during others, SA may act independently of NO.

8. CONCLUSION

As discussed in this chapter, the plant programmed cell death is necessary for proper plant growth and development. In addition, it is clearly involved in adaptive responses during many biotic and abiotic stress conditions. A role for SA signalling during PCD has been best characterised during HR-cell death. However, more recently, SA has also been implicated in other plant PCD events, notably following ozone exposure. The role of SA is, however, very much dependent on its interaction with other molecules, most particularly reactive oxygen species. The dissection of this love-hate relationship has benefited from the use of transgenics and mutants. It is clear today that the role of SA/ROS during plant stress responses can not be seen as static or linear. In fact, there exist a multitude of intrinsic and extrinsic signalling networks which regulate not only the biosynthesis but also the molecular targets of SA/ROS signalling. As a result, one can accept that SA behaves very much like other better known plant growth regulators and its role during PCD can be easily associated with that of a phytohormone. More work is still needed to assess the exact role of SA during PCD but today, there is irrefutable proof that SA is clearly a major player in the regulation of this crucial cellular process.

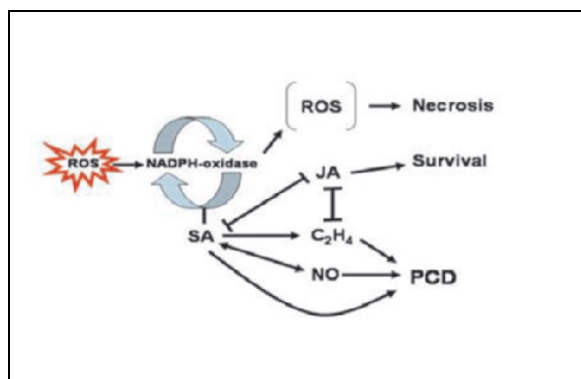

Figure 1. Schematic diagram showing the proposed regulatory network of signaling components involved in cell death regulation in plants. JA, jasmonic acid; NO, nitric oxide; ROS, reactive oxygen species; SA, salicylic acid.

9. ACKNOWLEDGEMENT

The authors are grateful to the Conseil Régional de Franche-Comté, le Ministère des Affaires Etrangères (PAI Tournesol N°08993ZL) and le Ministère de la Recherche et de la Technologie for financial support.

10. REFERENCES

- Abramovitch, R., and Martin, G., 2004. Strategies used by bacterial pathogens to suppress plant defenses. *Curr. Opin. Plant Biol.*, **7**: 1-9.
- Alvarez, M., Pennell, R., Meijer, P., Ishikawa, A., Dixon, R., and Lamb, C., 1998. Reactive oxygen intermediates mediate a systemic signal network in the establishment of plant immunity. *Cell*, **92**: 773-784.
- Antoniw, J., and White, R., 1980. The effects of aspirin on polyaromic acid on soluble leaf proteins and resistance to virus infection in five cultivars of tobacco. *Phytopath Z.*, **98**: 331-341.
- Baier, M., Kandlbinder, A., Gollack, D., and Dietz, K.-J., 2005. Oxidative stress and ozone: perception, signalling and response. *Plant Cell Env.*, **28**: 1012-1020.
- Balk, J., Leaver, C., and McCabe, P., 1999. Translocation of cytochrome c from the mitochondria to the cytosol occurs during heat-induced programmed cell death in cucumber plants. *Febs Lett.*, **463**: 141-154.
- Beligni, M., and Lamattina, L., 1999. Nitric oxide counteracts cytotoxic processes mediated by active oxygen species in plant tissues. *Planta*, **208**: 337-344.
- Bethke, P., and Jones, R., 2001. Cell death of barley aleurone proropasts is mediated by reactive oxygen species. *Plant J.*, **25**: 19-29.
- Bethke, P., Lonsdale, J., Fath, A., and Jones, R., 1999. Hormonally regulated programmed cell death in barley aleurone cells. *Plant Cell*, **11**: 1033-1045.

- Bhatia, M., 2004. Apoptosis versus necrosis in acute pancreatitis. *Am. J. Physiol.*, **286**: G189-G196.
- Bi, Y., Kenton, P., Mur, L., Darby, R., and Draper, J., 1995. Hydrogen peroxide does not function downstream of salicylic acid in the induction of PR protein expression. *Plant J.*, **8**: 235-245.
- Bidle, K., and Falhowski, P., 2004. Cell death in planktonic photosynthetic microorganisms. *Nature Rev.*, **2**: 643-655.
- Böhm, I., and Schild, H., 2003. Apoptosis: The complex scenario for a silent cell death. *Mol. Imag. Biol.*, **5**: 2-14.
- Bolwell, G., 1999. Role of active oxygen species and NO in plant defense responses. *Curr. Opin. Plant Biol.*, **2**: 287-294.
- Borsani, O., Valpuesta, V., and Botella, M., 2001. Evidence for a role of salicylic acid in the oxidative damage generated by NaCl and osmotic stress in Arabidopsis seedlings. *Plant Physiol.*, **126**: 1024-1030.
- Brodersen, P., Gro Malinovsky, F., Hématy, K., Newman, M., and Mundy, J., 2005. The role of salicylic acid in the induction of cell death in Arabidopsis *acd11*. *Plant Physiol.*, **138**: 1037-1045.
- Brodersen, P., Petersen, M., Pike, H., Olszak, B., Skov, S., Odum, N., et al, 2002. Knockout of Arabidopsis ACCELERATED-CELL-DEATH11 encoding a sphingosine transfer protein causes activation of programmed cell death and defense. *Genes Dev.*, **16**: 490-502.
- Casolo, V., Petrusa, E., Krajinakova, J., Macri, F., and Vianello, A., 2005. Involvement of the mitochondrial K(+)ATP channel in H₂O₂ or NO-induced programmed death of soybean suspension cell cultures. *J. Exp. Bot.*, **56**: 997-1006.
- Castagne, V., Barneoud, P., and Clarke, P., 1999. Protection of axotomized ganglion cells by salicylic acid. *Brain Res.*, **40**: 162-166.
- Chamhongpol, S., Willekens, H., Moeder, W., Langebartels, C., Sandermann, H., Van Montagu, M., Inzé, D., and Van Camp, W. 1998. Defense activation and enhanced pathogen tolerance induced in H₂O₂ in transgenic tobacco. *Proc. Natl. Acad. Sci. USA*, **95**: 5818-5823.
- Chen, H., Qualls, R., and GC, M., 2002. Adaptive responses of *Lepidium latifolium* to soil flooding: biomass allocation, adventitious roots, aerenchyma formation and ethylene production. *Env. Exp. Bot.*, **48**: 119-128.
- Chen, Z., and Klessig, D., 1991. Identification of a soluble salicylic acid-binding protein that may function in a signal transduction in the plant disease-resistance response. *Proc. Natl. Acad. Sci. USA.*, **88**: 8179-8183.
- Chen, Z., Ricigliano, J., and Klessig, D., 1993a. Purification and characterisation of a soluble salicylic acid-binding protein from tobacco. *Proc. Natl. Acad. Sci. USA.*, **90**: 9533-9537.
- Chen, Z., Silva, H., and Klessig, D., 1993b. Active oxygen species in the induction of plant systemic acquired resistance by salicylic acid. *Science*, **262**: 1883-1886.
- Chong, J., Pierrel, M., Atanassova, R., Werck-Reichhart, D., Fritig, B., and Saindrenan, P., 2001. Free and conjugated benzoic acid in tobacco plants and cell cultures. Induced accumulation upon elicitation of defense responses and role of salicylic acid precursors. *Plant Physiol.*, **125**: 318-328.
- Clarke, A., Desikan, R., Hurst, R., Hancock, J., and Neill, S., 2000. NO way back: nitric oxide and programmed cell death in Arabidopsis thaliana suspension cultures. *Plant J.*, **24**: 667-677.
- Conrath, U., Chen, Z., Ricigliano, J., and Klessig, D., 1995. Two inducers of plant defense responses, 2,6-dichloroisonicotinic acid and salicylic acid, inhibit catalase activity in tobacco. *Proc. Natl. Acad. Sci. USA.*, **92**: 7143-7147.

- Curtin, J., Donovan, M., and Cotter, T., 2002. Regulation and measurement of oxidative stress in apoptosis. *J. Immu. Meth.*, **265**: 49-72.
- Dangl, J., and Jones, J., 2001. Plant pathogens and integrated defense responses to infection. *Nature*, **411**: 826-833.
- Dat, J., Capelli, N., Folzer, H., Bourgeade, P., and Badot, P., 2004. Sensing and signalling during plant flooding. *PPB.*, **42**: 273-282.
- Dat, J., Foyer, C., and Scott, I., 1998b. Changes in salicylic acid and antioxidants during induced thermotolerance in mustard seedlings. *Plant Physiol.*, **118**: 1455-1461.
- Dat, J., Inzé, D., and Van Breusegem, F., 2001. Catalase-deficient plants: tools for in *Planta* studies on the role of hydrogen peroxide. *Redox Rep.*, **6**: 37-42.
- Dat, J., Lopez-Delgado, H., Foyer, C., and Scott, I., 1998a. Parallel changes in H₂O₂ and catalase during thermotolerance induced by salicylic acid or heat acclimation in mustard seedlings. *Plant Physiol.*, **116**: 1351-1357.
- Dat, J., Lopez-Delgado, H., Foyer, C., and Scott, I., 2000a. Effects of salicylic acid on oxidative stress and thermotolerance in tobacco. *J. Plant Physiol.*, **156**: 659-665.
- Dat, J., Pellinen, R., Beeckman, T., Van De Cotte, B., Langebartels, C., Kangasjarvi, J., Inzé, D., and Van Breusegem, F., 2003. Changes in hydrogen peroxide homeostasis trigger an active cell death process in tobacco. *Plant J.*, **33**: 621-632.
- Dat, J., Vandenabeele, S., Vranova, E., Van Montagu, M., Inzé, D., and Van Breusegem, F., 2000b. Dual action of the active oxygen species during plant stress responses. *CMLS.*, **57**: 779-795.
- Delaney, T., 1997. Genetic dissection of acquired resistance to disease. *Plant Physiol.*, **113**: 5-12.
- Delaney, T., Uknes, S., Bernooy, B., Friedrich, L., Weymann, K., Negrotto, D., et al, 1994. A central role of salicylic acid in plant disease resistance. *Science.*, **266**: 1247-1250.
- Delledonne, M., 2005. NO news is good news for plants. *Curr. Opin. Plant Biol.*, **8**: 390-396.
- Delledonne, M., Xia, Y., Dixon, R. and Lamb, C., 1998. Nitric oxide functions as a signal in plant disease resistance. *Nature.*, **394**: 585-588.
- Delledonne, M., Zeier, J., Marocco, A. and Lamb, C., 2001. Signal interactions between nitric oxide and reactive oxygen intermediates in the plant hypersensitive disease resistance response. *PNAS.*, **98**: 13454-13459.
- Dempsey, D., Shah, J. and Klessig, D., 1999. Salicylic acid and disease resistance in plants. *Crit. Rev. Plant Sci.*, **18**: 547-575.
- Desikan, R., Clarke, A., Hancock, J. and Neill, S., 1999. H₂O₂ activates a MAP kinase-like enzyme in *Arabidopsis thaliana* suspension cultures. *J. Exp. Bot.*, **50**: 1863-1866.
- Desikan, R., Mackerness, S., Hancock, J. and Neill, S., 2001. Regulation of the *Arabidopsis* transcriptome by oxidative stress. *Plant Physiol.*, **127**: 159-172.
- Dietrich, R., Delaney, T., Uknes, S., Ward, E., Ryals, J., and Dangl, J., 1994. *Arabidopsis* mutants simulating disease resistance response. *Cell*, **77**: 565-577.
- Doherty, H., Selvendran, R., and Bowles, D., 1988. The wound response of tomato plants can be inhibited by aspirin and related hydroxy-benzoic acids. *Physiol. Mol. Plant Path.*, **33**: 377-384.
- Doke, N., 1997. The oxidative burst: Roles in signal transduction and plant stress. In JG Scandalios (Ed.), *Oxidative stress and the molecular biology of antioxidant defenses*. Cold Spring Harbor Laboratory Press, Plainview: pp. 785-813.
- Dong, X., 2004. NPR1, all things considered. *Curr. Opin. Plant Biol.*, **7**: 547-552.
- Dordas, C., Hasinoff, B., Igamberdiev, A., Manac'h, N., Rivoal, J., and Hill, R., 2003. Expression of a stress-induced hemoglobin affects NO levels produced by alfalfa root cultures under hypoxic stress. *Plant J.*, **35**: 763-770.

- Dorey, S., Kopp, M., Geoffroy, P., Fritig, B., and Kauffmann, S., 1999. Hydrogen peroxide from the oxidative burst is neither necessary nor sufficient for hypersensitive cell death induction, phenylalanine ammonia lyase stimulation, salicylic acid accumulation, or scopoletin consumption in cultured tobacco cells treated with elicitor. *Plant Physiol.*, **121**: 163-171.
- Draper, J., 1997. Salicylate, superoxide synthesis and cell suicide in plant defense. *TIPS.*, **2**: 162-165.
- Drew, M., 1997. Oxygen deficiency and root metabolism: injury and acclimation under hypoxia and anoxia. *Annu. Rev. Plant Phys. Plant Mol. Biol.*, **48**: 223-250.
- Drew, M., He, C., and Morgan, P., 2000. Programmed cell death and aerenchyma formation in roots. *TIPS.*, **5**: 123-127.
- Durner, J., Wendehenne, D., and Klessig, D., 1998. Defense gene induction in tobacco by nitric oxide, cyclic GMP and cyclic ADP ribose. *Proc. Natl. Acad. Sci. USA.*, **95**: 10328-10333.
- Edwards, R., 1994. Conjugation and metabolism of salicylic acid in tobacco. *J. Plant Physiol.*, **143**: 608-614.
- Enyedi, A., Yalpani, N., Silverman, P., and Raskin, I., 1992. Localisation, conjugation, and function of salicylic acid in tobacco during the hypersensitive reaction to tobacco mosaic virus. *Proc. Natl. Acad. Sci. USA.*, **89**: 2480-2484.
- Evans, D., 2004. Tansley review: Aerenchyma formation. *New Phytol.*, **161**: 35-49.
- Feys, B., and Parker, J., 2000. Interplay of signalling pathways in plant disease resistance. *Tren. Gen.*, **16**: 449-455.
- Foyer, C., and Noctor, G., 2005. Redox homeostasis and antioxidant signaling: a metabolic interface between stress perception and physiological responses. *Plant Cell*, **17**: 1866-1875.
- Frank, S. and Barr, C., 2003. Programmed cell death and hybrid incompatibility. *J. Heredity*, **94**: 181-183.
- Fukuda, H., 2000. Programmed cell death of tracheary elements as a paradigm in plants. *Plant Mol. Biol.*, **44**: 245-253.
- Gaffney, T., Friedrich, L., Vernooij, B., Negrotto, D., Nye, G., Uknes, S., et al, 1993. Requirement of salicylic acid for induction of systemic acquired resistance. *Science*, **261**: 754-756.
- Glazener, J., Orlandi, E., and Baker, C., 1996. The active oxygen response of cell suspensions to incompatible bacteria is not sufficient to cause the hypersensitive cell death. *Plant Physiol.*, **110**: 759-763.
- Grant, J., and Loak, G., 2000. Role of reactive oxygen intermediates and cognate redox signalling in disease resistance. *Plant Physiol.*, **124**: 21-29.
- Greenberg, J., 1996. Programmed cell death: A way of life for plants. *Proc. Natl. Acad. Sci. USA.*, **93**: 12094-12097.
- Groom, Q., Torres, M., Forham-Skelton, A., Hammond-Kosack, K., Robinson, N., and Jones, J., 1996. *rbohA*, a rice homologue of the mammalian gp91phox respiratory burst oxidase gene. *Plant J.*, **10**: 515-522.
- Groover, A., DeWitt, N., Heidel, A., and Jones, A., 1997. Programmed cell death of plant tracheary elements differentiating in vitro. *Protoplasma*, **196**: 197-211.
- Guan, L., and Scandalios, J., 1995. Developmentally related responses of maize catalase genes to salicylic acid. *Proc. Natl. Acad. Sci. USA.*, **92**: 5930-5934.
- Gunawardena, A., Greenwood, J., and Dengler, N., 2004. Programmed cell death remodels lace plant leaf shape during development. *Plant Cell*, **16**: 60-73.

- Gunawardena, A., Pearce, D., Jackson, M., Hawes, C., and Evans, D., 2001a. Characterization of programmed cell death during aerenchyma formation by ethylene or hypoxia in roots of maize (*Zea mays L.*). *Planta*, **212**: 205-214.
- Gunawardena, A., Pearce, D., Jackson, M., Hawes, C., and Evans, D., 2001b. Rapid changes in cell wall pectic polysaccharides are closely associated with early stages of aerenchyma formation, a spatially localized form of programmed cell death in roots of maize promoted by ethylene. *Plant Cell Env.*, **24**: 1369-1375.
- Haddad, J., 2004. Redox and oxidant-mediated regulation of apoptosis signalling pathways: immuno-pharmacoredox conception of oxidative siege versus cell death commitment. *Int. Immunopharm.*, **4**: 475-493.
- Hancock, J., Desikan, R., Clarke, A., Hurst, R., and Neill, S., 2002. Cell signalling following plant/pathogen interactions involves the generation of reactive oxygen and reactive nitrogen species. *PPB.*, **40**: 611-617.
- Hancock, J., Desikan, R., and Neill, S., 2001. Role of active oxygen species in cell signalling pathways. *Bioch Soc. Trans.*, **29**: 345-350.
- He, C., Drew, M., and Morgan, P., 1994. Induction of enzymes associated with lysigenous aerenchyma formation in roots of *Zea mays* during hypoxia and nitrogen starvation. *Plant Physiol.*, **105**: 861-865.
- He, C., Morgan, P., and Drew, M., 1996. Transduction of an ethylene signal is required for cell death and lysis in the root cortex of maize during aerenchyma formation induced by hypoxia. *Plant Physiol.*, **112**: 463-472.
- He, Y., Liu, Y., Cao, W., Huai, M., Xu, B., and Huang, B., 2005. Effects of salicylic acid on heat tolerance associated with antioxidant metabolism in Kentucky Bluegrass. *Crop Sci.*, **45**: 988-995.
- Heath, M., 2000. Hypersensitive response-related death. *Plant Mol. Biol.*, **44**: 321-334.
- Henzler, T., and Stuedle, E., 2000. Transport and metabolic degradation of hydrogen peroxide in *Chara corallina*: model calculations and measurement with the pressure probe suggest transport of H₂O₂ across water channels. *J. Exp. Bot.*, **51**: 2053-2066.
- Hildeman, D., 2004. Regulation of T-cell apoptosis by reactive oxygen species. *Free Rad. Biol. Med.* **36**: 1496-1504.
- Hoeberichts, F., and Woltering, E., 2002. Multiple mediators of plant programmed cell death mechanisms and plant-specific regulators. *BioEssays*, **25**: 47-57.
- Houot, V., Etienne, P., Petitot, A., Barbier, S., Blein, J., and Suty, L., 2001. Hydrogen peroxide induces programmed cell death features in cultured tobacco BY-2 cells, in a dose-dependent manner. *J. Exp. Bot.*, **52**: 1721-1730.
- Huang, X., Stettmaier, K., Michel, C., Hutzler, P., Mueller, M., and Durner, J., 2004. Nitric oxide is induced by wounding and influences jasmonic acid signaling in *Arabidopsis thaliana*. *Planta*, **218**: 939-946.
- Jabs, T., 1999. Reactive oxygen intermediates as mediators of programmed cell death in plants and animals. *Biochem. Pharma.*, **57**: 231-245.
- Jabs, T., Dietrich, R., and Dangl, J., 1996. Initiation of runaway cell death in an *Arabidopsis* mutant by extracellular superoxide. *Science*, **273**: 1853-1856.
- Janda, T., Szalai, G., Tari, I., and Paldi, E., 1999. Hydroponic treatment with salicylic acid decrease the effects of chilling injury in maize (*Zea mays L.*) plants. *Planta*, **208**: 175-180.
- Jones, A., 2000. Does the mitochondria integrate cellular stress and regulate programmed cell death? *TIPS.*, **5**: 225-230.
- Jones, J., and Dangl, J., 1996. Logjam at the Styx: programmed cell death in plants. *TIPS.*, **1**: 114-119.
- Kachroo, P., Shanklin, J., Shah, J., Whittle, E., and Klessig, D., 2001. A fatty acid desaturase modulates the activation of defense signaling pathways in plants. *PNAS.*, **98**: 9448-9453.

- Kadota, Y., Watanabe, T., Fujii, S., Higashi K., Sano, T., Nagata, T., et al, 2004. Crosstalk between elicitor-induced cell death and cell cycle regulation in tobacco BY-2 cells. *Plant J.*, **40**: 131-142.
- Kangasjarvi, J., Jaspers, P., and Kollist, H., 2005. Signalling and cell death in ozone-exposed plants. *Plant Cell Env.*, **28**: 1021-1036.
- Karpinski, S., Gabrys, H., Mateo, A., Karpinska, B., and Mullineaux, P., 2003. Light perception in plant disease defence signalling. *Curr. Opin. Plant Biol.*, **6**: 390-396.
- Karpinski, S., Reynolds, H., Karpinska, B., Wingsle, G., Creissen, G., and Mullineaux, P., 1999. Systemic signalling and acclimation in response to excess excitation energy in *Arabidopsis*. *Science*, **284**: 654-657.
- Kawai, K., Samarajeewa, P., Barrero, R., Nishiguchi, M., and Uchimiya, H., 1998. Cellular dissection of the degradation pattern of cortical cell death during aerenchyma formation of rice roots. *Planta*, **204**: 277-287.
- Kawasaki, T., Henmi, K., Ono, E., Hatakeyama, S., Iwano, M., Satoh, H., and Shimamoto, K., 1999. The small GTP-binding protein rac is a regulator of cell death in plants. *Proc. Natl. Acad. Sci. USA.*, **96**: 10922-10926.
- Keller, T., Damude, H., Werner, D., Doerner, P., Dixon, R., and Lamb, C., 1998. A plant homolog of the neutrophil NADPH-oxidase gp91phox subunit gene encodes a plasma membrane protein with Ca²⁺ binding motifs. *Plant Cell*, **10**: 255-266.
- Kende, H., 1993. Ethylene biosynthesis. *Ann. Rev. Plant Phys. Plant Mol. Biol.*, **44**: 283-307.
- Klepper, L., 1991, NOx evolution by soybean leaves treated by salicylic acid and selected derivatives. *Pest Biochem Physiol.*, **39**: 43-48.
- Kloek, A., Verbsky, M., Sharma, S., Schoelz, J., Vogel, J., Klessig, D., and Kunkel, B., 2001. Resistance to *Pseudomonas syringae* conferred by an *Arabidopsis thaliana* coronatine-insensitive (coi1) mutation occurs through two distinct mechanisms. *Plant J.*, **26**: 509-522.
- Koch, J., Creelman, J., Eshita, S., Seskar, M., Mullet, J., and Davis, K., 2000. Ozone sensitivity in hybrid poplar correlates with insensitivity to both salicylic acid and jasmonic acid: the role of programmed cell death in lesion formation. *Plant Physiol.*, **123**: 1-10.
- Korsmeyer, S., Yin, X., Oltvai, Z., Veis-Novack, D., and Linette, G., 1995. Reactive oxygen species and the regulation of cell death by the Bcl-2 gene family. *Biochem. Biophys. Acta*, **1271**: 63-66.
- Kowaltowski, A., Castilho, R., and Vercesi, A., 2001. Mitochondrial permeability transition and oxidative stress. *Febs Lett.*, **495**: 12-15.
- Kunkel, B., and Brooks, D., 2002. Cross talk between signaling pathways in pathogen defense. *Curr. Opin. Plant Biol.*, **5**: 325-331.
- Kuriyama, H., and Fukuda, H., 2002. Developmental programmed cell death in plants. *Curr. Opin. Plant Biol.*, **5**: 568-573.
- Kwak, J., Mori, I., Pei, Z., Leonhardt, N., Torres, M., Dangl, J., et al, 2003. NADPH oxidase *AtrbohD* and *AtrbohF* genes function in ROS-dependent ABA signaling in *Arabidopsis*. *Embo J.*, **22**: 2623-2633.
- Laloi, C., Apel, K., and Danon, A., 2004. Reactive oxygen signalling: the latest news. *Curr. Opin. Plant Biol.*, **7**: 232-328.
- Lam, E., 2004. Controlled cell death, plant survival and development. *Nature Rev.*, **5**: 305-315.
- Lam, E., Kato, N., and Lawton, M., 2001. Programmed cell death, mitochondria and the hypersensitive response. *Nature*, **411**: 848-853.
- Langebartels, C., Wohlge-muth, H., Kschieschan, S., Grun, S., and Sandermann, H., 2002. Oxidative burst and cell death in ozone-exposed plants. *PPB.*, **40**: 567-575.

- Larkindale, J., Hall, J., Knight, M., and Vierling, E., 2005. Heat stress phenotypes of *Arabidopsis* mutants implicate multiple signaling pathways in the acquisition of thermotolerance. *Plant Physiol.*, **138**: 882-897.
- Leon, J., Lawton, M., and Raskin, I., 1995. Hydrogen peroxide stimulates salicylic acid biosynthesis in tobacco. *Plant Physiol.*, **108**: 1673-1678.
- Levine, A., Tenhaken, R., Dixon, R., and Lamb, C., 1994. H₂O₂ from the oxidative burst orchestrates the hypersensitive response. *Cell*, **79**: 583-593.
- Lopez-Delgado, H., Dat, J., Foyer, C., and Scott, I., 1998. Induction of thermotolerance in potato microplasants by acetylsalicylic acid and H₂O₂. *J. Exp. Bot.*, **49**: 713-730.
- Lorbiecke, R., and Sauter, M., 1999. Adventitious root growth and cell-cycle induction in deepwater rice. *Plant Physiol.*, **119**: 21-29.
- Mach, J., Castillo, A., Hoogstraten, R., and Greenberg, J., 2001. The *Arabidopsis*-accelerated cell death gene *ACD2* encodes red chlorophyll catabolite reductase and suppresses the spread of disease symptoms. *Proc. Natl. Acad. Sci. USA.*, **98**: 771-776.
- Malamy, J., Carr, J., Klessig, D., and Raskin, I., 1990. Salicylic acid: a likely endogenous signal in the resistance for tobacco mosaic viral infection. *Science*, **250**: 1002-1004.
- Malamy, J., and Klessig, D., 1992. Salicylic acid and plant disease resistance. *Plant J.*, **2**: 643-654.
- Masuda, Y., Yamada, T., and Marubashi, W., 2003. Time course analysis of apoptotic cell death during expression of hybrid lethality in hybrid tobacco cells (*Nicotiana suaveolens* x *N. tabacum*). *Plant Cell Env.*, **44**: 420-427.
- Mauch-Mani, B., and Slusarenko, A., 1996. Production of salicylic acid precursors is a major function of phenylalanine ammonia-lyase in the resistance of *Arabidopsis* to *Peronospora parasitica*. *Plant Cell*, **8**: 203-212.
- McCabe, and Leaver, C., 2000. Programmed cell death in cell cultures. *Plant Mol. Biol.*, **44**: 359-368.
- McCabe, P., Levine, A., Meijer, P., Tapon, N., and Pennell, R., 1997. A programmed cell death pathway activated in carrot cells cultured at low density. *Plant J.*, **12**: 267-280.
- Métraux, J., 2002. Recent breakthroughs in the study of salicylic acid biosynthesis. *TIPS.*, **7**: 1-3.
- Métraux, J., Signer, H., Ryals, J., Ward, E., and Wyss-Benz, M., 1990. Increase in salicylic acid at the onset of systemic acquired resistance in cucumber. *Science*, **250**: 1004-1006.
- Mikolajczyk, M., Awotunde, O., Muszynska, G., Klessig, D., and Dobrowolska, G., 2000. Osmotic stress induces rapid activation of a salicylic acid-induced protein kinase and a homolog of protein kinase ASK1 in tobacco cells. *Plant Cell*, **12**: 165-178.
- Mittler, R., 2002. Oxidative stress, antioxidants and stress tolerance. *TIPS.*, **7**: 405-410.
- Mittler, R., Herr, E., Orvar, B., Van Camp, W., Willekens, H., Inzé, D., and Ellis, B., 1999. Transgenic tobacco plants with reduced capability to detoxify reactive oxygen intermediates are hyper-responsive to pathogen attack. *Proc. Natl. Acad. Sci. USA.*, **96**: 14165-14170.
- Mittler, R., Vanderauwera, S., Gollery, M., and Van Breusegem, F., 2004. Reactive oxygen gene network of plants. *TIPS.*, **9**: 490-498.
- Moeder, W., Barry, C., Tauriainen, A., Betz, C., Tuomainen, J., Utriainen, M., Grierson, D., Sandermann, H., Langebartels, C. and Kangasjarvi, J., 2002. Ethylene synthesis regulated by bi-phasic induction of 1-aminocyclopropane-1-carboxylic acid synthase and 1-aminocyclopropane-1-carboxylic acid oxidase genes is required for H₂O₂ accumulation and cell death in ozone-exposed tomato. *Plant Physiol.*, **130**: 1918-1926.
- Molina, A., Bueno, P., Marlin, M., Rodriguez-Rosales, M., Belver, A., Venema, K., and Danaiere, J., 2002. Involvement of endogenous salicylic acid content lipoxygenase and antioxidant enzyme activities in response of tomato cell suspension cultures to NaCl. *New Phytol.*, **156**: 409-415.

- Montillet, J., Chammongpol, S., Rusterucci, C., Dat, J., Van De Cotte, B., Agnel, J., Battesti, C., Inzé, D., Van Breusegem, F., and Triantaphylides, C., 2005. Fatty acid hydroperoxides and H₂O₂ in the execution of hypersensitive cell death in tobacco leaves. *Plant Physiol.*, **138**: 1516-1526.
- Moore, A., Albury, M., Crichton, P., and Affourtit, C., 2002. Function of the alternative oxidase: is it still a scavenger? *TIPS.*, **7**: 478-481.
- Nawrath, C., and Métraux, J., 1999. Salicylic acid induction-deficient mutants of *Arabidopsis* express PR-2 and PR-5 and accumulate high levels of camalexin after pathogen inoculation. *Plant Cell*, **11**: 1393-1404.
- Nibbe, M., Hilpert, B., Wasternack, C., Miersch, O., and Apel, K., 2002. Cell death and salicylate- and jasmonate-dependent stress responses in *Arabidopsis* are controlled by single genes. *Planta*, **216**: 120-128.
- Noctor, G., and Foyer, C., 1998. Ascorbate and glutathione: keeping active oxygen under control. *Annu. Rev. Plant Phys. Plant Mol. Biol.*, **49**: 249-279.
- O'Brien, I., Baguley, B., Murray, B., Morris, B., and Ferguson, I., 1998. Early stages of the apoptotic pathway in plant cells are reversible. *Plant J.*, **13**: 803-814.
- Ono, E., Wong, H., Kawasaki, T., Hasegawa, M., Kodama, O., and Shimamoto, K., 2001. Essential role of the small GTPase Rac in disease resistance of rice. *Proc. Natl. Acad. Sci. USA.*, **98**: 759-764.
- Orozco-Cardenas, M., Narvaez-Vasquez, J., and Ryan, C., 2001. Hydrogen peroxide acts as a secondary messenger for the induction of defense genes in tomato plants in response to wounding, systemin, and methyl jasmonate. *Plant Cell*, **13**: 179-191.
- Orvar, B., McPherson, J., and Ellis, B., 1997. Pre-activating wounding response in tobacco prior to high-level ozone exposure prevents necrotic injury. *Plant J.*, **11**: 203-212.
- Overmyer, K., Broché, M., Pellinen, R., Kuittinen, T., Tuominen, H., Ahlfors, R., Keinänen, M., Saarma, M., Scheel, D. and Kangasjarvi, J. 2005. Ozone-induced programmed cell death in the *Arabidopsis radical-induced cell death1* mutant. *Plant Physiol.*, **137**: 1092-1104.
- Overmyer, K., Pellinen, R., Kuittinen, T., Betz, C., Langebartels, C., Sandermann, H., and Kangasjarvi, J., 2000. The ozone-sensitive *Arabidopsis rcd1* mutant reveals opposite roles for ethylene and jasmonate signalling pathways in regulating superoxide-dependent cell death. *Plant Cell*, **12**: 1849-1862.
- Pellinen, R., Korhonen, M., Tauriainen, A., Palva, E., and Kangasjarvi, J., 2002. Hydrogen peroxide activates cell death and defense gene expression in birch. *Plant Physiol.*, **130**: 549-560.
- Pellinen, R., Palva, J., and Kangasjarvi, J., 1999. Subcellular localization of ozone-induced hydrogen peroxide production in birch (*Betula pendula*) leaf cells. *Plant J.*, **20**: 349-356.
- Pennell, R., and Lamb, C., 1997. Programmed cell death in plants. *Plant Cell*, **9**: 1157-1168.
- Petersen, M., Brodersen, P., Naested, H., Andreasson, E., Lindhart, U., Johansen, B., Nielsen, H., Lacy, M., Austin, M., and Parker, J. 2000. Arabidopsis map kinase 4 negatively regulates systemic acquired resistance. *Cell*, **103**: 1111-1120.
- Petit, P., Santos-Antonio, S., Zamzami, N., Mignotte, B., and Kroemer, G., 1996. Mitochondria and programmed cell death: back to the future. *FEBS Lett.*, **396**: 7-13.
- Rao, M., and Davis, K., 2000. The physiology of ozone induced cell death. *Planta.*, **213**: 682-690.
- Rao, M., and Davis, R., 1999. Ozone-induced cell death occurs via two distinct mechanisms in *Arabidopsis*: the role of salicylic acid. *Plant J.*, **17**: 603-614.
- Rao, M., and Davis, R., 2001. The physiology of ozone-induced cell death. *Planta*, **213**: 682-690.

- Rao, M., Koch, J., and Davis, K., 2000. Ozone: a tool for probing programmed cell death in plants. *Plant Mol. Biol.*, **44**: 345-358.
- Rao, M., Lee, H.-I., and Davis, K., 2002. Ozone-induced ethylene production is dependent on salicylic acid, and both salicylic acid and ethylene act in concert to regulate ozone-induced cell death. *Plant J.*, **32**: 447-456.
- Rao, M., Paliyath, G., Ormrod, D., Murr, D., and Watkins, C., 1997. Influence of salicylic acid on H₂O₂ production, oxidative stress, and H₂O₂-metabolizing enzymes. *Plant Physiol.*, **115**: 137-149.
- Raskin, I., 1992. Role of salicylic acid in plants. *Annu. Rev. Plant Phys. Plant Mol. Biol.*, **43**: 439-463.
- Rasmussen, J., Hammerschmidt, R., and Zook, M., 1991. Systemic induction of salicylic acid accumulation in cucumber after inoculation with *Pseudomonas syringae* pv *syringae*. *Plant Physiol.*, **97**: 1342-1347.
- Rate, D., Cuenca, J., Bowman, G., Guttman, D., and Greenberg, J., 1999. The gain-of-function Arabidopsis *acd6* mutant reveals novel regulation and function of the salicylic acid signaling pathway in controlling cell death, defenses, and cell growth. *Plant Cell*, **11**: 1695-1708.
- Ribnicky, D., Shuvalov, V., and Raskin, I., 1998. Intermediates of salicylic acid biosynthesis in tobacco. *Plant Physiol.*, **118**: 565-572.
- Rizhsky, L., Hallak-Herr, E., Van Breusegem, F., Rachmilevitch, S., Barr, J., Rodermel, S., Inzé, D., and Mittler, R. 2002. Double antisense plants lacking ascorbate peroxidase and catalase are less sensitive to oxidative stress than single antisense plants lacking ascorbate peroxidase or catalase. *Plant J.*, **32**: 329-342.
- Robson, C., and Vanlerberghe, G., 2002. Transgenic plant cells lacking mitochondrial alternative oxidase have increased susceptibility to mitochondrial-dependent and -independent pathways of programmed cell death. *Plant Physiol.*, **129**: 1908-1920.
- Rogers, E., and Ausubel, F., 1997. Arabidopsis enhanced disease susceptibility mutants exhibit enhanced susceptibility to several bacterial pathogens and alterations in PR-1 gene expression. *Plant Cell*, **9**: 305-316.
- Rubenstein, B., 2000. Regulation of cell death in flower petals. *Plant Mol. Biol.*, **44**: 303-318.
- Ryals, J., Neuenschwander, U., Willits, M., Molina, A., Steiner, H. and Hunt, M., 1996. Systemic acquired resistance. *Plant Cell*, **8**: 1809-1819.
- Ryan, C. and Jadendorf, A., 1995. Self defense by plants. *Proc. Natl. Acad. Sci. USA.*, **92**: 4075.
- Samuilov, V., Oleskin, A., and Lagunova, E., 2000. Programmed cell death. *Biochem. (Moscow)*, **65**: 873-887.
- Sanchez-Casas, P., and Klessig, D., 1994. A salicylic acid-binding activity and a salicylic acid-inhibitable catalase activity are present in a variety of plant species. *Plant Physiol.*, **106**: 1675-1679.
- Sandermann, H., Ernst, D., Heller, W., and Langebartels, C., 1998. Ozone: an abiotic elicitor of plant defense reactions. *TIPS.*, **3**: 47-50.
- Scandalios, J., 1997. Molecular genetics of superoxide dismutases in plants. In JG Scandalios (Ed.) *Oxidative Stress and the Molecular Biology of Antioxidant defenses. Cold Spring Harbor Laboratory Press, New York.* pp. 353-406.
- Schraudner, M., Moder, W., Wiese, C., Van Camp, W., Inzé, D., Lam, E., Langebartels, C., and Sandermann, H., 1998. Ozone-induced oxidative burst in the ozone biomonitor plant, tobacco Bel W3. *Plant J.*, **16**: 235-245.
- Schussler, E., and Longstreth, D., 2000. Changes in cell structure during the formation of root aerenchyma in *Sagittaria lancifolia*. *Am. J. Bot.*, **87**: 12-19.

- Senaratna, T., Touchell, D., Bunn, E., and Dixon, K., 2000. Acetyl salicylic acid and salicylic acid induce multiple stress tolerance in bean and tomato plants. *Plant Growth Regul.*, **30**: 157-161.
- Shah, J., 2003. The salicylic acid loop in plant defense. *Curr. Opin. Plant Biol.*, **6**: 365-371.
- Sharma, Y., and Davis, K., 1997. The effects of ozone on antioxidant responses in plants. *Free Rad. Biol. Med.*, **23**: 480-488.
- Sharma, Y., Leon, J., Raskin, I., and Davis, K., 1996. Ozone-induced responses in *Arabidopsis thaliana*: the role of salicylic acid in the accumulation of defense-related transcripts and induced resistance. *Proc. Natl. Acad. Sci. USA.*, **93**: 5099-5104.
- Shirasu, K., Nakajima, H., Krishnamachari, R., Dixon, R., and Lamb, C., 1997. Salicylic acid potentiates an agonist-dependent gain control that amplifies pathogen signals in the activation of defense mechanisms. *Plant Cell*, **9**: 261-270.
- Siegrist, J., Jeblick, W., and Kauss, H., 1994. Defense responses in infected and elicited cucumber (*Cucumis sativus L.*) hypocotyl segments exhibiting acquired resistance. *Plant Physiol.*, **105**: 1365-1374.
- Silverman, P., Seskar, M., Kanter, D., Schweizer, P., Métraux, J., and Raskin, I., 1995. Salicylic acid in rice. Biosynthesis, conjugation and possible role. *Plant Physiol.*, **108**: 633-639.
- Simon-Plas, F., Elmayan, T., and Blein, J., 2002. The plasma membrane oxidase NtrbohD is responsible for AOS production in elicited tobacco cells. *Plant J.*, **31**: 137-147.
- Slaymaker, D., Navarre, D., Clark, D., del Pozo, O., Martin, G., and Klessig, D., 2002. The tobacco salicylic acid-binding protein 3 (SABP3) is the chloroplast carbonic anhydrase, which exhibits antioxidant activity and plays a role in the hypersensitive defense response. *Proc. Natl. Acad. Sci. USA.*, **99**: 11640-11645.
- Smirnov, S., Shulaev, V., and Turner, N., 1997. Expression of pokeweed antiviral protein in transgenic plants induces virus resistance in grafted wild-type plants independently of salicylic acid accumulation and pathogenesis-related protein synthesis. *Plant Physiol.*, **114**: 1113-1121.
- Solomon, Belenghi, B., Delledonne, M., Menachem, E., and Levine, A., 1999. The involvement of cysteine proteases and protease inhibitor genes in the regulation of programmed cell death in plants. *Plant Cell*, **11**: 431-443.
- Song, F., and Goodman, R., 2001. Activity of nitric oxide is dependent on, but is partially required for function of, salicylic acid in the signaling pathway in tobacco systemic acquired resistances. *Mol. Plant-Micro. Inter.*, **14**: 1458-1462.
- Souter, M., and Lindsey, K., 2000. Polarity and signalling in plant embryogenesis. *J. Exp. Bot.*, **51**: 971-983.
- Spoel, S., Koornneef, A., Claessens, S., Korzelius, J., Van Pelt, J., Mueller, M., Bauchala, A., Métraux, J., Brown, R., and Kazan, K., 2003. NPR1 modulates cross-talk between salicylate- and jasmonate-dependent defense pathways through a novel function in the cytosol. *Plant Cell*, **15**: 760-770.
- Sticher, L., Mauch-Mani, B., and Métraux, J., 1997. Systemic acquired resistance. *Annu. Rev. Phytopatho.*, **35**: 325-370.
- Summermatter, K., Sticher, L., and Métraux, J., 1995. Systemic responses in *Arabidopsis thaliana* infected and challenged with *Pseudomonas syringae pv syringae*. *Plant Physiol.*, **108**: 1379-1385.
- Swidzinski, J., Leaver, C., and Sweetlove, L., 2004. A proteomic analysis of plant programmed cell death. *Phytochem.*, **65**: 1829-1838.
- Swidzinski, J., Sweetlove, L., and Leaver, C., 2002. A custom microarray analysis of gene expression during programmed cell death in *Arabidopsis thaliana*. *Plant J.*, **30**: 431-446.

- Takahashi, H., Chen, Z., Du, H., Liu, Y., and Klessig, D., 1997. Development of necrosis and activation of disease resistance in transgenic tobacco plants with severely reduced catalase levels. *Plant J.*, **11**: 993-1005.
- Tanaka, S., Hayakawa, K., Umetani, Y., and Tabata, M., 1990. Glucosylation of isomeric hydroxybenzoic acids by cell suspension cultures of *Mallotus japonicus*. *Phytochem.*, **29**: 1555-1558.
- Tenhaken, R., and Rubel, C., 1997. Salicylic acid is needed in hypersensitive cell death in soybean but does not act as a catalase inhibitor. *Plant Physiol.*, **115**: 291-298.
- Thomas, H., Ougham, H., Wagstaff, C., and Stead, A., 2003. Defining senescence and death. *J. Exp. Bot.*, **54**: 1127-1132.
- Torres, M., and Dangl, J., 2005. Functions of the respiratory burst oxidase in biotic interactions, abiotic stress and development. *Curr. Opin. Plant Biol.*, **8**: 397-403.
- Torres, M., Dangl, J., and Jones, J., 2002. *Arabidopsis* gp91phox homologues *AtrbohD* and *AtrbohF* are required for the accumulation of reactive oxygen intermediates in the plant defense response. *Proc. Natl. Acad. Sci. USA.*, **99**: 523-528.
- Torres, M., Onouchi, H., Hamada, S., Machida, C., Hammond-Kosack, K., and Jones, J., 1998. Six *Arabidopsis thaliana* homologues of the human respiratory burst oxidase (gp91phox). *Plant J.*, **14**: 365-370.
- Tuomainen, J., Betz, C., Kangasjarvi, J., Ernst, D., Yin, Z., Langebartels, C., and Sandermann, H., 1997. Ozone induction of ethylene emission in tomato plants: Regulation by differential accumulation of transcripts for the biosynthetic enzymes. *Plant J.*, **12**: 1151-1162.
- Uknes, S., Dincher, S., Friedrich, L., Negrotto, D., Williams, S., Thompson-Taylor, H., Potter, S., Ward, E., and Ryals, J., 1993. Regulation of pathogenesis-related protein-1a gene expression. *Plant Cell*, **5**: 159-169.
- Van Camp, W., Van Montagu, M., and Inzé, D., 1998. H₂O₂ and NO: redox signals in disease resistance. *TIPS.*, **3**: 330-334.
- Vandenabeele, S., Van Ser Kelen, K., Dat, J., Gadjev, I., Boonefaes, T., Morsa, S., Rottiers, P., Slooten, L., Van Montagu, M., Zabeau, M., Inzé, D., and Van Breusegem, F., 2003. A comprehensive analysis of hydrogen peroxide-induced gene expression in tobacco. *Proc. Natl. Acad. Sci. USA.*, **100**: 16113-16118.
- Vandenabeele, S., Vanderauwera, S., Vuylsteke, M., Rombauts, S., Langebartels, C., Seidlitz, H., Zabeau, M., Van Montagu, M., Inzé, D., and Van Breusegem, F., 2004. Catalase deficiency drastically affects gene expression induced by high light in *Arabidopsis thaliana*. *Plant J.*, **39**: 45-58.
- Vanderauwera, S., Zimmermann, P., Rombauts, S., Vandenabeele, S., Langebartels, C., Griissem, W., Inzé, D., and Van Breusegem, F., 2005. Genome-wide analysis of hydrogen peroxide regulated gene expression in *Arabidopsis* reveals a high light-induced transcriptional cluster involved in anthocyanin biosynthesis. *Plant Physiol.*, **139**: 806-821.
- Vanlerberghe, G., Robson, C., and Yip, J., 2002. Induction of mitochondrial alternative oxidase in response to a cell signal pathway down-regulating the cytochrome pathway prevents programmed cell death. *Plant Physiol.*, **129**: 1829-1842.
- Vartapatian, B., and Jackson, M., 1997. Plant adaptations to anaerobic stress. *Ann. Bot.*, **79**: 3-20.
- Vidal, S., Eriksson, A., Montesano, M., Denecke, J., and Tapio Talva, E., 1997. Cell wall degrading enzymes from *Erwinia carotovora* cooperate in the salicylic acid-independent induction of a plant defence response. *Mol. Plant-Micro. Inter.*, **11**: 23-32.
- Vranova, E., Inzé, D., and Van Breusegem, F., 2002. Signal transduction during oxidative stress. *J. Exp. Bot.*, **53**: 1227-1236.

- Wang, K., Li, H., and Ecker, J., 2002. Ethylene biosynthesis and signaling networks. *Plant Cell*, **14**: S131-S151.
- Ward, E., Uknes, S., Williams, S., Dincher, S., Wiederhold, D., Alexander, D., Ahl-Goy, P., Métraux, J., and Ryals, J., 1991. Coordinate gene activity in response to agents that induce systemic acquired resistance. *Plant Cell*, **3**: 1085-1094.
- White, R., 1979. Acetylsalicylic acid (aspirin) induces the resistance to tobacco mosaic virus in tobacco. *Virology*, **99**: 410-412.
- Wildermuth, M., Dewdney, J., Wu, G., and Ausubel, F., 2001. Isochorismate synthase is required to synthesize salicylic acid for plant defense. *Nature*, **414**: 562-565.
- Willekens, H., Langebartels, C., Tiré, C., Van Montagu, M., Inzé, D., and Van Camp, W., 1994. Differential expression of catalase in *Nicotiana plumbaginifolia* L. *Proc. Natl. Acad. Sci. USA*, **91**: 10450-10454.
- Yalpani, N., Enyedi, A., Leon, J., and Raskin, I., 1994. Ultraviolet light and ozone stimulate accumulation of salicylic acid and pathogenesis-related proteins and virus resistance in tobacco. *Planta*, **193**: 373-376.
- Yalpani, N., Schulz, M., Davis, M., and Balke, N., 1992. Partial purification and properties of an inducible uridine 5'-diphosphate-glucose: salicylic acid glucosyltransferase from oat roots. *Plant Physiol.*, **100**: 457-463.
- Yalpani, N., Silverman, P., Wilson, T., Kleier, S., and Raskin, I., 1991. Salicylic acid is a systemic signal and an inducer of pathogenesis-related proteins in virus infected tobacco. *Plant Cell*, **3**: 809-818.
- Yang, Y., Qi, M., and Mei, C., 2004. Endogenous salicylic acid protects rice plants from oxidative damage caused by aging as well as biotic and abiotic stress. *Plant J.*, **40**: 909-919.
- Yoshioka, H., Numata, N., Nakajima, K., Katou, S., Kawakita, K., Rowland, O., et al, 2003. *Nicotiana benthamiana* gp91(phox) homologue *NbrbohA* and *NbrbohB* participate in H₂O₂ accumulation and resistance to *Phytophthora infestans*. *Plant Cell*, **15**: 706-718.
- Young, T., and Gallie, D., 2000. Programmed cell death during endosperm development. *Plant Mol. Biol.*, **44**: 283-301.
- Zhao, Y., Thilmony, R., Bender, C., Schaller, A., He, S., and Howe, G., 2003. Virulence systems to *Pseudomonas syringae* pv. tomato promote bacterial speck disease in tomato by targeting the jasmonate signalling pathway. *Plant J.*, **36**: 485-499.

Chapter 10

SALICYLIC ACID AS A DEFENSE-RELATED PLANT HORMONE

ROLES OF OXIDATIVE AND CALCIUM SIGNALING PATHS IN SALICYLIC ACID BIOLOGY

TOMONORI KAWANO¹ AND TAKUYA FURUICHI²

¹ Graduate School of Environmental Engineering, The University of Kitakyushu, Kitakyushu 808-0135, Japan; ² Graduate School of Medicine, Nagoya University, Showa-ku, Nagoya 466-8550, Japan.

Abstract: Salicylic acid (SA) is a natural signaling molecule involved in plant defense response against pathogen infection. This chapter covers the recent progress in our understanding of the SA biology in plants, especially the signaling pathways and mechanisms by which SA performs its role as defense inducer are highlighted. The topics related to SA signal transduction covered here include (1) general biological roles played by SA; (2) biosynthesis, storage and translocation of SA; (3) oxidative SA metabolisms regulating the SA actions; (4) roles of reactive oxygen species and calcium ion in SA signaling paths; (5) the link between oxidative burst and other signaling paths; and (6) regulation of gene expression. Lastly, we illustrated the key signaling networks that coordinately lead to both early and late phases of SA-induced gene expression.

Key words: Calcium, gene expression, plant defense, reactive oxygen species, salicylic acid, signal transduction

Abbreviations: ABA, abscisic acid; *as-1*, activation sequence-1; BA2H, benzoic acid 2-hydroxylase; BCMT, benzenoid carboxyl methyltransferase; BTH, 7-carboxybenzothiadiazole; CDPK, calcium-dependent protein kinase; CaM, calmodulin; $[Ca^{2+}]_c$, cytosolic free Ca^{2+} concentration; DHBA, dihydroxybenzoic acid; DPI, diphenyleneiodonium; e^- , electron; ELP, Euphorbia characias latex peroxidase; ESR, electron spin resonance; HO^{\cdot} , hydroxyl radical; HR, hypersensitive response; HRP, horseradish peroxidase; ICS, isochorismate synthase; INA, 2,6-dichloroisonicotinic acid; IPL, isochorismate pyruvate-lyase; JA, jasmonic acid; MAPK, mitogen-activated protein kinase; NahG, bacterial salicylate hydroxylase gene; *npr1*, nonexpresser of PR genes 1; $O_2^{\cdot-}$, superoxide anion; PAL, phenylalanine

ammonia-lyase, PR-protein (gene), pathogenesis-related protein (gene); Probenazole, 3-allyloxy-1,2-benzisothiazole-1,1-dioxide; ROS, reactive oxygen species; rboh, respiratory burst oxidase homolog; SA, salicylic acid; SABP, salicylic acid binding protein; saccharin, 1,2-benzisothiazole-3(2H)-one 1,1-dioxide; SAG, salicylic acid β -glucoside; SAGase, salicylic acid β -glucosidase; SAGT, salicylic acid 3-O-glucosyltransferase; SAmE, methyl salicylate; SAMT, salicylic acid methyltransferase; SAR, systemic acquired resistance; SHAM, salicylhydroxamic acid; SIPK, SA-induced protein kinase; TMV, tobacco mosaic virus; TNV, tobacco necrosis virus; *TPC1*, two pore channel 1; VDCC, voltage-dependent Ca^{2+} -permeable channel; WIPK, wounding-induced protein kinase.

1. INTRODUCTION

Salicylic acid (SA) is a signaling molecule naturally found in plants and shown to be involved in the plant defense-related actions against infection by various pathogens. Biology of SA has a long history, dating back to the ancient time, very much prior to application of SA for combating the plant diseases. Plant crude extracts containing phenolics such as SA, saligenin and its glucoside salicin (Fig. 1) have been used as sorts of medicinal agents for humans. Actually the name of SA and related compounds originally came from the *Salix helix* (willow) tree, since they were discovered as the major components in the extracts from willow tree bark or poplar tree bark that had been used as natural anti-inflammatory drugs over centuries until 18th century (Rainsford, 1984; Weissman, 1991). Acetylsalicylic acid which is widely known as aspirin is the world first synthetic drug that had been produced in 1897 by Bayer Company as anti-inflammatory agent by mimicking the action of the ancient medicine from the willow tree (Weissman, 1991). Since then aspirin became one of the most popular drugs among the people and has been widely used for more than one century. Studies relating salicylates with plant disease resistance was initiated in 1970s when the application of aspirin against a plant virus in growing leaves was shown to be effective (White 1979).

As discovered by John Vane, the action of aspirin as anti-inflammatory drug in humans is mainly manifested via inactivation of the cyclooxygenase component of prostaglandin synthase (Vane and Botting, 2003). However, the modes of SA action as a 'plant medicine' largely differ from this animal model. Interestingly, instead of acting as an anti-inflammatory agent, SA shows the heat-generating activity by targeting the mitochondrial alternative oxidase in some plant species (Voodoo lilies) and the heat generation reportedly results in inducing flowering (Rhoads and McIntosh, 1992). Thus SA occasionally behaves as a flowering hormone in specific plant species.

Among the diversified actions of SA in plants, the most important role for SA may be being an endogenous inducer of plant defense mechanism against the pathogen attacks.

As mentioned above, White (1979) and his colleague (Antoniw and White, 1980) were the first plant biologists who paid attention to salicylates as disease resistance-inducing chemicals. They demonstrated that injection of aspirin into tobacco leaves enhanced the resistance to subsequent infection by tobacco mosaic virus (TMV). Later studies have shown that aspirin and SA (shown to be more effective) induce the accumulation of pathogenesis-related (PR) proteins (Kessmann and Ryals, 1993; Malamy *et al.*, 1990; Métraux *et al.*, 1990). To date, a variety of possible receptors and corresponding signaling mechanisms has been proposed. There were two key papers in early 1990s, firstly proposing the modes of SA signal transduction in plants. Raz and Fluhr (1992) proposed a signaling mechanism involving Ca^{2+} -dependent cascade for the first time, since they observed that removal of Ca^{2+} or blockade of Ca^{2+} uptake results in the inhibition of the SA-inducible accumulation of a PR-protein (chitinase) both in the cells and leaves of tobacco. This observation was confirmed in various plant materials such as carrot cell culture (Schneider-Müller *et al.*, 1994). Chen *et al.* (1993a) have proposed the involvement of reactive oxygen species (ROS) as key signals that relay SA signals in plants, since they have shown that SA binds and inhibits catalase, the enzyme that catalyzes the decomposition of H_2O_2 . Therefore, roles for H_2O_2 and ROS derived from H_2O_2 as SA signal mediators were suggested for the first time. These studies opened the door for SA studies regarding calcium signaling and oxidative bursts.

This article overviews the significant progress in our understanding of the SA biology in plants, especially by emphasizing the oxidative and calcium signaling mechanisms by which SA performs its role as defense inducer.

2. BIOSYNTHESIS, STORAGE AND TRANSLOCATION OF SA

2.1 Active forms of salicylates and related chemicals

In Fig. 2, structures of SA and active SA analogs having defense response-inducing/stimulating activities are shown. Such active SA analogs include aspirin, 2,6-dihydroxybenzoic acid (2,6-DHBA), 2,6-dichloroisonicotinic acid (INA) and 7-carboxybenzothiadiazole (BTH). 2,6-DHBA is a SA analog active in the induction of SA 3-*O*-glucosyltransferase

(SAGT) in tobacco leaves (Enyedi and Raskin, 1993) and immediate oxidative burst in tobacco cell suspension culture (Kawano *et al.*, 2004a). INA (Conrath *et al.*, 1995) and BTH (Feys *et al.*, 2001) are widely accepted active analogs of SA. 4-chlorosalicylic acid, 5-chlorosalicylic acid and 3,5-dichlorosalicylic acid were shown to be active in the induction of PR-1 protein accumulation and enhancement of disease resistance in tobacco leaf discs (Conrath *et al.*, 1995). In addition, these 3 analogs were reported to be much more active, compared to SA and INA, in binding to catalase and its inhibition (Conrath *et al.*, 1995). SA, aspirin, and methoxybenzoic acid are equally active in catalase inhibition, generation of superoxide ($O_2^{\cdot-}$), and induction of transient increase in cytosolic Ca^{2+} concentration ($[Ca^{2+}]_c$) in tobacco cell suspension culture (Kawano *et al.*, 1998).

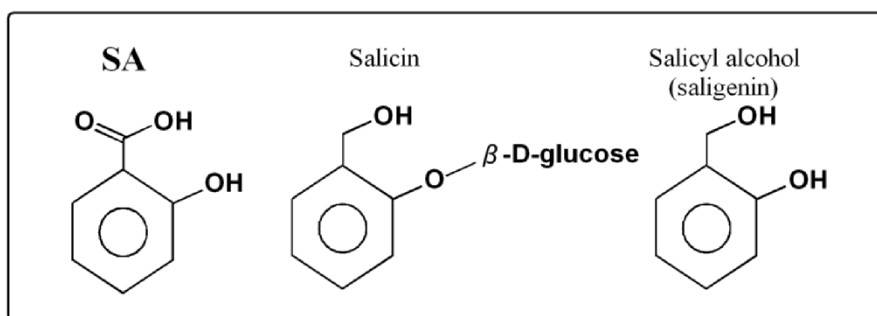

Figure 1. SA and related compounds naturally found in the extracts from ground bark of willow (*Salix*) and poplar (*Populus*) trees. The prefix for these compounds 'salic-' came from *salix* plants. Salicin can be readily converted to saligenin by beta-glucosidase.

In general, the chemicals with benzoate back bone possessing electro-negative groups (-OH, -OCOCH₃, -OCH₃, -Cl, and -S-) at aromatic rings especially at *ortho*-positions behave as good SA analogs. Therefore, the presence of electro-negative groups is one of the criteria for being a good SA analog. Blockade of -OH group of SA with large group such as glucose (i.e. SA β -glucoside, 2-*O*- β -D-glucosylbenzoic acid, designated as SAG, see Fig. 3 for structure) results in lowered activity in the induction of immediate oxidative burst (Kawano *et al.*, 1998). Instead, SAG treatment can induce a long-lasting and sustainable oxidative burst since in the *in vivo* conditions SAG can be gradually hydrolyzed into glucose and active free SA (Kawano *et al.*, 2004a). When tobacco BY-2 cells were pretreated with low concentration of SA, 30 min prior to SAG treatment, an enhanced response to SAG in the induction of ROS ($O_2^{\cdot-}$) production, probably reflecting the enhanced conversion of SAG to SA, was observed (Kawano *et al.*, 2004a). This phenomenon was considered as one of SA-dependent priming effects.

Presence of free carboxylic acid group is also important. When the carboxylic acid moiety of SA and aspirin were blocked as the forms methyl or glucose esters such as methyl salicylate (SAmE), methyl aspirin, and SA glucose ester, or replaced with aldehyde group (salicylaldehyde), SA-inducible early defense responses such as immediate oxidative burst were no

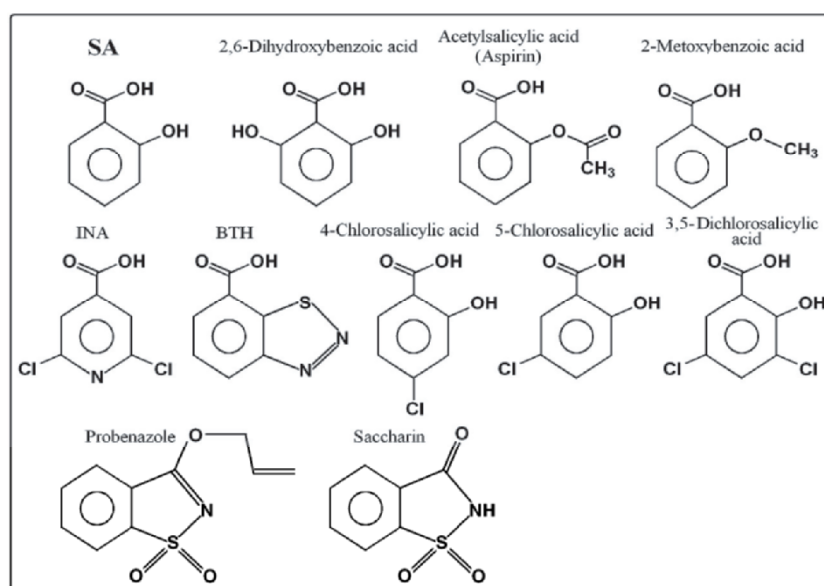

Figure 2. Active analogs of SA. INA, 2,6-dichloroisonicotinic acid; BTH, 7-carboxybenzothiadiazole

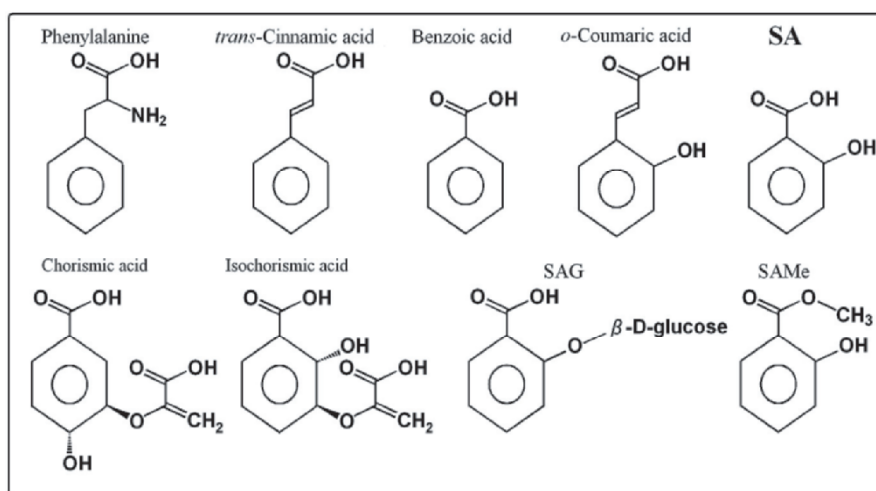

Figure 3. Precursors and storage forms of SA in plants. SAG, salicylic acid glucoside. SAmE, methyl SA.

longer inducible (Kawano *et al.*, 1998). Since SAME can be found in various plants, its role as an air-borne SA intermediate (to be exchanged between plant individuals), rather than active form of SA, has been considered (Shulaev *et al.*, 1997).

Probenazole (3-allyloxy-1,2-benzisothiazole-1,1-dioxide) and saccharin (1,2-benzisothiazole-3(2H)-one 1,1-dioxide) are distinct members of defense inducers, possessing no carboxyl group (Fig. 2). Probenazole has been originally designed for inducing the resistance against the rice blast fungus *Magnaporthe grisea* in rice plants (Midoh and Iwata, 1996). Recent studies have shown that probenazole can act as a defense-inducing agent both in rice (Song and Goodman, 2002) and *Arabidopsis thaliana* (Yoshioka *et al.*, 2001a). In our preliminary experiments, we observed that saccharin, a compound structurally similar to probenazole, added to tobacco cell suspension culture induces the SA-like immediate oxidative burst very effectively (unpublished results). It is tempting to speculate that –CO-NH- moiety of saccharin is mimicking the role of SA's –COOH group and the –SO₂- moiety positioned next to –CO-NH- moiety (being *ortho*-position on the arene ring) is functioning as the required electro-negative moiety.

2.2 Pathways and regulation of SA biosynthesis

To date, two distinct pathways for biosynthesis of SA in plants have been elucidated. The earlier works revealed that phenylalanine, *trans*-cinnamic acid, benzoic acid, and/or *ortho*-coumaric acid are the possible precursors for SA biosynthesis in plants (Fig.3). Production of SA starting from phenylalanine occurs in the cytoplasm of a variety of plants such as tobacco and cucumber (Fig. 4a). This pathway obviously shares its precursors with the phenylpropanoid pathway. More recent studies propounded that SA could be produced from chorismic acid and isochorismic acid, two known products in the shikimate pathway (Fig.3). The conversion of these newly found precursors to SA takes place in the plastids in *Arabidopsis* (Fig. 4b).

In plants, an array of compounds, often found in chemical and physical defense mechanisms against invasion by pathogens, are produced from *trans*-cinnamic acid, the first metabolite in the phenylpropanoid pathway (Kawano *et al.*, 2004b). The compounds produced via phenylpropanoid pathway include lignin, flavonoids, phenolics, phytoalexins and SA.

Production of SA from *trans*-cinnamic acid is reportedly mediated with the formation of benzoic acid (Ward *et al.*, 1991), although some earlier experiments suggested that *o*-coumaric acid is also involved (Sticher *et al.*, 1997) probably in rare cases not participating in the rapid SA biosynthesis induced by pathogens such as TMV (Raskin, 1995). In tobacco plants, production of *trans*-cinnamic acid from phenylalanine by phenylalanine

ammonia-lyase (PAL) contributes to the development of resistance against fungal invasion through the production of benzoic acid that leads to SA, but not *via* production of *p*-coumaric acid from which lignin, flavonoids, and phytoalexins can be produced in the downstream paths (Serino *et al.*, 1995; Mauch-Mani and Sulsarenko, 1996).

Benzoic acid 2-hydroxylase (BA2H) is an enzyme involved at the final step of SA production (i.e. conversion of benzoic acid to SA) and it is known that this key enzyme is induced by the inoculation of virus (TMV) to the leaves of tobacco (*Nicotiana tabacum* L. cv Xanthi-nc) (Léon *et al.*, 1993). Also in cucumber plants, injection of ¹⁴C-labeled benzoic acid to cotyledons reportedly results in the accumulation of ¹⁴C-labeled SA in phloem (Mölders *et al.*, 1996). This conversion of benzoic acid to SA requires the inoculation of tobacco necrosis virus (TNV), suggesting that SA biosynthesis and its transport take place in the early phase of the virus-stimulated development of systemic acquired resistance (SAR) against broad spectrum of pathogens (Mölders *et al.*, 1996).

On the other hand, some researchers are accumulating the data which are strong enough to question the role of phenylalanine paths in *A. thaliana*, despite some early studies have suggested that plants synthesize SA from phenylalanine. Especially in *A. thaliana*, SA could be produced even when the phenylalanine path was blocked, and some radio-labeling experiments were indicative of the fact that the rate of conversion of SA precursors in the phenylalanine path to SA may be unexpectedly low (Wildermuth *et al.*, 2001). Interestingly, studies on bacterial siderophores have suggested that SA production in bacteria is free from the phenylalanine path, and instead some bacteria surely produce SA by coupling the activities of isochorismate synthase (ICS) and isochorismate pyruvate-lyase (IPL) (Mercado-Blanco *et al.*, 2001).

Recent drastic progress in the search for biosynthetic pathway of SA has outlined that the bacterial type of SA biosynthesis also functions in plants (Fig. 4b). From the cell cultures of *Catharanthus roseus*, the first plant ICS has been isolated and this ICS was shown to be highly homologous to the bacterial ICS isozymes (van Tegelen *et al.*, 1999). In addition, a possible role for plant ICSs in SA biosynthesis *via* isochorismate production was proposed for the first time (van Tegelen *et al.*, 1999). Next year, a group from Leiden University has shown that transgenic tobacco plants with over-expressions of the chloroplast-targeted bacterial enzymes (both ICS and IPL) overproduce SA at 500- to 1000-fold higher levels, compared to the control plants (Verberne *et al.*, 2000). In 2001, Swiss groups successfully produced a novel hybrid enzyme possessing 'SA synthase' activity, by fusing two bacterial genes *pchA* and *pchB*, isolated from *Pseudomonas aeruginosa*, encoding ICS and IPL, respectively (Mauch *et al.*, 2001). Then, the ICS-IPL

fusion enzyme was over-expressed in *A. thaliana* under the control of CaMV 35S promoter. Targeting of this chimeric enzyme protein to the plastids resulted in notably higher level of SA production and PR gene expression, while the targeting of this protein to cytoplasm resulted in relatively lower enhancement of SA production (Mauch *et al.*, 2001). These data indicated that the levels of substrate for ICS-IPL enzyme in different intracellular compartments limit the level of the final product, SA, and therefore suggest that appropriate localization of the enzyme in the right place is necessary. In the same year, a breakthrough in SA biosynthesis research was reported by Wildermuth *et al.* (2001). They observed that *A. thaliana* plants synthesize SA from chorismic acid by means of an ICS equivalent, designated as *ICS1*. Furthermore, it has been shown that this pathway is required for both local and systemic resistance responses. The *A. thaliana ICS1* gene possesses a putative plastid-transit sequence and a cleavage site, implying an important role for ICS in the chloroplasts, utilizing chorismate as a substrate synthesized in the chloroplasts (Wildermuth *et al.*, 2001). Our concern is how the SA synthesis mediated by this pathway is regulated during the plant defense responses against pathogen attacks. Our recent review article discussed possible models dealing with SA-dependent regulation of SA biosynthesis during the development of SAR (Kawano *et al.*, 2004b).

2.3 Storing SA as inactive forms

In plants, inter-conversion between SA and SA β -glucoside (SAG; 2-*O*- β -D-glucosylbenzoic acid) occurs as illustrated in Fig. 4c. In higher plants, SA is stored mainly as SAG rather than free form (Klick and Herrmann, 1988). Enyedi *et al.* (1992) and Malamy *et al.* (1992) have reported independently that SAG increases in parallel with free SA in the tobacco leaves that had acquired resistance to infection by TMV, indicating that a larger portion of SA is likely converted to SAG and stored when the excess of SA is present in plants. Elicitors such as chitosan components are known to elevate the SAG content while free SA level is unchanged (Messner and Schroder, 1999). Overproduction of SA in transgenic plants expressing SA-producing bacterial enzymes (Verberne *et al.*, 2000; Mauch *et al.*, 2001) and a TIR-NBS-LRR type R gene mutant *ssi4* (Shirano *et al.*, 2002) reportedly result in increased SAG contents. SAG contents in potato leaves and cell culture are reportedly elevated following interaction with a pathogenic fungus *Phytophthora infestans* and elicitors derived from this pathogen (Keller *et al.*, 1996), suggesting the possible roles for SAG in defense mechanism.

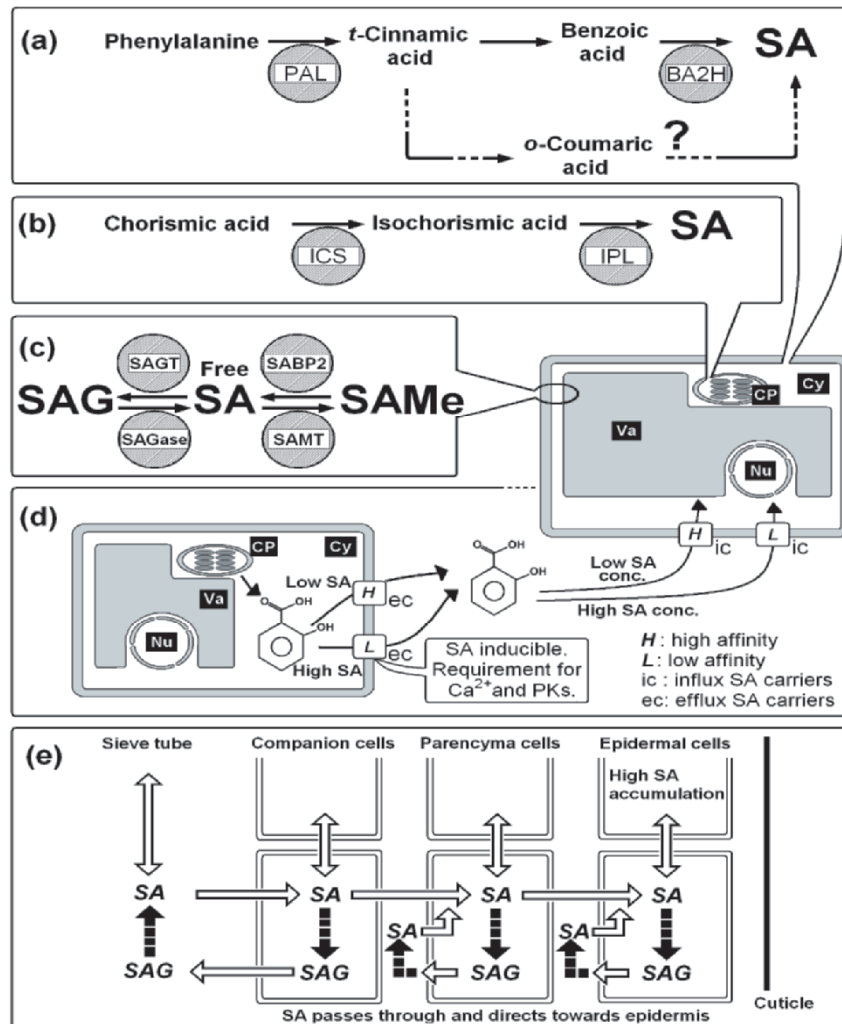

Figure 4. Biosynthesis and translocation of SA. Largely modified from Kawano *et al.* (2004b). (a) Typical SA biosynthetic path found in the cytosol of tobacco, cucumbers and other plants, involving PAL and BA2H as key enzymes. (b) Novel SA biosynthetic path found mainly in the chloroplasts of *A. thaliana* involving ICS and IPL as key enzymes. (c) Inter-conversions between SA and SAG, and SA and SAME. SAGase, SAGT, SABP2, and SAMT are the enzymes involved in SAME-SA-SAG inter-conversions. (d) Movement of SA at cellular level. (e) Movement of SA at tissue level.

According to Hennig *et al.* (1993), both endogenous SAG and exogenously applied SAG are hydrolyzed to yield SA and SAG is likely active only after hydrolysis to SA for induction of *PR-1* gene in tobacco leaves. Thus, SAG seems to be an storage form from which physiologically

active free SA is released when required (Seo *et al.*, 1995). In tobacco leaves, the hydrolysis of SAG occurs in the extracellular (intercellular) spaces (Henning *et al.*, 1993) where considerable activity of SA β -glucosidase (SAGase) is present (Seo *et al.*, 1995), despite the formation of SAG from SA catalyzed by SAGT occurs intracellularly and the vacuole is considered as the major SA reservoir (Hennig *et al.*, 1993). Taken together, it is likely that SAG is partially excreted by an unidentified mechanism, to the apoplast where the SAG-degrading enzyme (SAGase) and SA-utilizing enzymes are abundant, thus free SA could be released from SAG, and utilized for defense-related reactions such as oxidative burst (Fig. 4c).

In some tutorial reviews, SAG and salicin (both are good substrate for beta-glucosidase) are mixed up or confused (possibly due to similarity in structures and confusing names). Similarly to SAGase, a SAG-specific beta-glucosidase, generally beta-glucosidases are capable of degrading salicin to yield saligenin (Fig. 1). In the early days, we had bitter experience in an attempt to use salicin in addition to SAG for assessing the total changes in SA-releasing beta-glucosidase activities in plants, by monitoring glucose release due to SAG hydrolysis or salicin hydrolysis by employing the automated glucose analyzer equipped with glucose oxidase membrane. However, both SA and saligenin released from SAG and salicin were shown to be reversibly but highly inhibitory to the glucose oxidase activity and thus the detection of released glucose could not be monitored.

Since the methylated form of SA (SAME) is inactive compared to free SA (Kawano *et al.*, 1998), we can assume that SAME is an alternative storage form of SA, in addition to SAG. Therefore, some enzymes involved in methylation and demethylation are important. Several enzymes in charge of methylation of SA and related compounds have been isolated in the last 5 years and most of them were comprehensively investigated at the biochemical, molecular biological and structural levels (Fukami *et al.*, 2002; Pott *et al.*, 2003, 2004). Benzenoid carboxyl methyltransferases (BCMTs) synthesize methyl esters such as SAME and methyl benzoates and contribute to aromas and scents of many plant species and play important roles in plant communication with the surrounding environment (Effmert *et al.*, 2005). Among BCMTs, the benzoic acid methyltransferase-type enzymes favor benzoates as substrates and the salicylic acid methyltransferase (SAMT)-type enzymes favor SA as a substrate (Effmert *et al.*, 2005). In Fig. 4c, SAMT is placed as the key enzyme involved in SAME formation from SA.

Recently, Forouhar *et al.* (2005) have reported a successful demonstration that SA-binding protein isolated from tobacco, designated as SABP2 (SA-binding protein 2) has strong esterase activity with SAME as substrate. Therefore, release of free SA from SAME by SABP2 may contribute to rapid SA increase in emergency during plant defense

mechanism (Fig. 4c). SABP2 is a 25-kDa protein showing higher affinity for SA compared to catalase (Du and Klessig, 1997). Based on sequence analysis, SABP2 was shown to be a lipase, belonging to α/β fold hydroxylase super family, and recombinant SABP2 expressed in *E. coli* was shown to have lipase activity (Kumar and Klessig, 2003). Interestingly, the lipase activity of recombinant SABP2 was enhanced by 3.8-fold in the presence of SA. Since, RNAi-based silencing of *SABP2* gene expression in tobacco resulted in strong suppression of local resistance to TMV, *PR-1* induction, and development of SAR (Kumar and Klessig, 2003), the role for SABP2 as a key component in SA signal transduction has been proposed. The latest study is in support of the role of SA-binding to SABP2, as the step for negative feedback in which excess of SA down-regulates the release of SA from the storage form of SA (Forouhar *et al.*, 2005).

2.4 SA transport and its regulation

The induction of SAR following a localized infection requires some kind of long distance communication mediators moving through the phloem since earlier demonstrations showed that blocking of phloem transmission by stem girdling prevents the induction of SAR in leaves distal to the block (Delaney, 2004). Later findings in tobacco and cucumber guided us that SA is likely moving inside the pathogen-infected plants, to the upper non-infected leaves from lower infected leaves through the phloem (Métraux *et al.*, 1990; Rasmussen *et al.*, 1991; Yalpani *et al.*, 1991).

In TMV-resistant Xanthi-nc tobacco, SA levels increase systemically following the inoculation of a single leaf with TMV. Consistent with the proposed role for SA as a long-distance moving signal, the experiments with $^{18}\text{O}_2$ -labelling showed that SA produced in TMV-infected leaves of Xanthi-nc tobacco can spread systemically (Shulaev *et al.*, 1995). Similarly, Mölders *et al.* (1996) have demonstrated that radioactivity of ^{14}C -labeled benzoic acid applied together with tobacco necrosis virus (TNV), to cotyledons of cucumber seedlings can be transported through phloem to upper leaves only after conversion to ^{14}C -SA, indicating that SA rather than benzoic acid is the translocatable form. As a result, the SA derived from the site of TNV inoculation into the upper young leaves successfully induced SAR.

In contrast, Vernooij *et al.* (1994) have performed an experiment opposing the view that SA is a vascular-mobile signal in the induction of virus-induced SAR. Their grafting experiments using transgenic tobacco plants that express *NahG* gene coding for a bacterial SA-degrading enzyme, showed that *NahG* tobacco root-stocks (not capable of SA accumulation) inoculated with TMV were fully capable of delivering a signal allowing the

nontransgenic scions to resist the secondary TMV infection. Based on this result, they concluded that the vascular-mobile SAR-inducing signal is not SA. Their experimental designs were so elegant but the results must be dealt with caution since a small amount of residual SA is still present in *NahG* plants (Delaney, 2004). In addition, *NahG* transgene merely contribute to the degradation of accumulating SA without affecting the SA synthesis, thus its impact on translocation of produced SA is obscure. As discussed in the later section on, *NahG* biochemistry, the authors think that SA-removal activity in the vascular systems in *NahG* plants may not be high. To judge the significance of *NahG* grafting experiment, further radio-labeling analysis using the *NahG* grafted plants is required.

In our previous publication, we made an overview on the possible control of local and systemic SA levels through SA movements 'in' and 'out' of the cells, tissues and organs (Kawano *et al.*, 2004b). As shown in Fig. 4 (a and b), SA is produced inside the cells, and thus a key step in SA movement is excretion of SA by the cells. Recently a group from Taiwan has shown that SA can smoothly move in and out of the plant cells and this process is finely regulated by ROS and Ca^{2+} (Chen *et al.* 1999, 2001). They showed that ^{14}C -labeled free SA (200 μM) added to tobacco cells in suspension can be rapidly absorbed by the cells (within 5 min), and with time the majority (over 90 %) of the radioactivity can be released back to the extracellular medium as free SA (by 5 h). Possible mechanism for excretion of SA at cell level proposed by Chen *et al.* (1999, 2001) is summarized in Fig. 4d. This model is mimicking each component cell during cell-to-cell SA translocation reported by Ohashi *et al.* (2004), in which SA can pass-by each cell as shown in Fig. 4e (see below paragraphs). When the cells are exposed to high dose of SA (200 μM), *de novo* induction of SA excretion process reportedly takes place (Chen *et al.*, 2001). This process requires the production of ROS and subsequent cascades of Ca^{2+} signaling and protein phosphorylation. In addition, there is a likely alternative SA transport process responsive to low-dose of exogenously applied SA (20 μM). The low-dose SA-responsive SA excretion process requires no *de novo* protein synthesis and is constitutively active independent of ROS, Ca^{2+} and protein kinase. These data indicate the presence of two distinct SA efflux carrier(s) constitutively present and newly produced in response to exogenous SA.

Similar to SA excretion control, induction of PR-protein (protein N) is differently regulated by the respective signaling mechanisms corresponding to high- and low-dose SA excretion controls (Chen *et al.*, 2002). The higher SA (200 μM)-dependent process is likely relaying the SA signal to induce protein N through ROS, Ca^{2+} and protein phosphorylation, while lower SA (20 μM)-dependent mechanism induces protein N independently from above signaling events.

In mammals, the presence of carrier-mediated SA absorption mechanism has been elucidated by tracing the fate of ^{14}C -SA (Utoguchi *et al.*, 1999; Emoto *et al.*, 2002). The reported SA influx carriers pH-dependently support the uptake of SA by mammalian cells and tissues both *in vivo* and *in vitro*, requiring low extracellular pH and higher intracellular pH, thus sensitive to protonophores and NaN_3 . By analogy, in plants, the mechanisms involving some carriers of SA supporting the SA uptake and release, must be examined in the future studies since above studies strongly suggest that plant cells possibly possess some SA carriers.

As illustrated in Fig. 4e, Ohashi and her colleagues have carefully reexamined the distribution of SA without co-inoculation with pathogen (Ohashi *et al.*, 2004). By using ^{14}C -labeled SA, they have shown that translocation of SA is unexpectedly rapid when applied exogenously onto the cut end of the petiole from young and adult tobacco plants. Monitoring of the ^{14}C signal movement was done after feeding ^{14}C -SA (1 - 10 μl of 60 μM - 2 mM) to the petiole end of the adult plants with 13 expanded leaves. The signal reached to 6 neighboring upper leaves and 3 adjacent lower leaves within 10 min, and accumulated throughout the plant body in further 50 min in each treated plant. Accordingly, major part of SA may have migrated as free form rather than glucosylated form, especially in the early phase of SA translocation examined within 10 min after SA addition. Therefore, translocation of SA inside the plants is smooth enough to allow the systemic distribution of SA signal within a short period. In contrast, there is an effective barrier to SA disperse, surrounding the plant body. Niederl *et al.* (1998) has shown that ^{14}C -SA can penetrate through the cuticle and the path may allow transport of only a negligible quantity of SA, at normal physiological range of pH (>3, \leq 6). Ohashi *et al.* (2004) also showed that ^{14}C -SA solution placed onto the surface of the tobacco leaves without piercing the cuticle layers hardly passes through the barrier and thus almost no signal could be translocated within 1 h, indicating that the role of cuticle as the barrier at the plant surface is tight enough for preventing the passive penetration of SA (Ohashi *et al.*, 2004). In addition, the suggested form of SA highly active in cuticular penetration is SAME (Niederl *et al.*, 1998). Thus, methylation of SA which results in pH-independent diffusion across the outer physical barriers of plants, may partially affect the SA balance in plants.

From the models in Fig. 4 (d and e), we can expect that the cells closed to the SA feeding points, in the works of Ohashi *et al.* (2004) using 60 μM -2 mM of ^{14}C -SA, were likely exposed to high range of SA concentration, thus it is possible that SA uptake and excretion may depend on the Ca^{2+} /ROS-regulated process (Chen *et al.*, 1999, 2001). In contrast, the low-dose SA *via* Ca^{2+} /ROS-independent process may be active in the cells distant from the

SA feeding points. Now we could have overview on SA biosynthesis and translocation, then we have to think of the modes of action of SA.

3. SA OXIDATION AND THE MODES OF SA ACTION

We would like to start discussing the mode of SA action by looking at the SA oxidation mechanisms which are expected to give us some key hints to the SA signaling mechanisms. Here, we focus on three different mechanisms for the oxidative SA degradation. One of these mechanisms is an artificial reaction forced by transgene manipulation and the other two are the reactions naturally occurring during oxidative bursts in plants. By examining the three different ways of SA degradation shown in Fig. 5, we can make close approaches to SA signaling.

3.1 *NahG*-dependent SA oxidation

To date, researchers have been accumulating the evidences on the involvement of SA at various phases of plant defense. One of the strongest tools for testing the SA involvement has been the *NahG* transgene encoding bacterial salicylate hydroxylase, a flavoprotein, which converts SA to catechol (Friedrich *et al.*, 1995; Hunt *et al.*, 1996; Alvarez, 2000). The salicylate hydroxylase expressed in plants catalyzes the NADH- and O₂-dependent conversion of SA to catechol via decarboxylative hydroxylation (Fig. 5a). Mechanistic studies with *Pseudomonas* salicylate hydroxylase suggested that SA and NADH randomly bind to the enzyme in the first step, resulting in a reduced enzyme-substrate complex. This in turn captures O₂ and leads to the production of the hydroxylated substrate, CO₂, and water (White-Stevens and Kamin, 1972). Therefore, the lack of cofactors such as O₂ and NADH may result in lowered catalytic activity of the enzyme. Recently, the use of a microsensor for oxygen enabled the exact measurement of O₂ levels in the phloem of living higher plants (*Ricinus communis*) and thus impact of altered O₂ levels in the vascular metabolism could be investigated (van Dongen *et al.*, 2003). In the stem (diameter 19 mm) of adult plants growing in normal air (21% [v/v] O₂), the O₂ level was shown to be lowest in the vascular region (7% [v/v] O₂) adjacent to the surface, which is low enough to restrict a variety of energy consuming metabolisms, while the hollow center of the stem has twice greater O₂ level (15% [v/v]). This is one of the reasons why the authors think that salicylate hydroxylase may not be fully active in SA removal in the vascular system (if any exists), as discussed in the section for SA transport.

Catechol, the oxidation product of the salicylate hydroxylase reaction, has long been considered as an inert molecule not affecting the action of SA in plants. However, some recent studies are opposing this view. One of the representative *NahG* phenotype reported for *NahG* expressing Arabidopsis is the lowered non-host resistance to a *Pseudomonas syringae* pv. *phaseolicola* strain, but a recent report presented the data questioning the effect of *NahG* transgene and therefore, the reliability of *NahG* experiments judging the involvement of SA was very much weakened (van Wees *et al.*, 2003). The reported work uncovered that the by-product of *NahG* action, catechol may be the actual player eventually lowering the non-host resistance to the pathogen. The report thus propounded that any conclusion about SA requirement based solely on phenotypes of *NahG* plants should be reevaluated. Further investigations on *NahG* side effects are required for solidly evaluating the work with *NahG* plants.

3.2 SA is readily oxidized by HO[•]

While the *NahG*-dependent oxidation of SA leading to the release of catechol is the reaction found only in transgenic plants, other oxidation processes leading to the release of catechol are likely to take place in nature. As studies with animal systems have shown that exogenously administrated aspirin and SA can act as effective scavengers of HO[•] *in vivo* (Aubin *et al.*, 1998; Sagone and Husney, 1987), SA is one of the strongest scavengers for HO[•], while generation of O₂^{•-} (Kawano *et al.*, 1998) and H₂O₂ (Kawano and Muto, 2000) are stimulated in plant cells. Also in tobacco cell suspension culture, we have demonstrated the HO[•] removal activity of SA by using electron spin resonance (ESR) spectroscopy (Kawano and Muto, 2000). The structures of likely products due to SA-HO[•] interaction *in vivo*, namely 2,3- and 2,5-DHBAs and catechol, are shown in Fig. 5b, and these products often report the production of HO[•] *in vivo* (Grootveld and Halliwell, 1986; Halliwell *et al.*, 1991). Since 2,5-DHBA but not 2,3-DHBA can also be produced by the activity of cytochrome P-450 (Ingelman-Sundberg *et al.*, 1991), therefore, production of 2,5-DHBA may be the evidence for SA-HO[•] interaction only in the absence of corresponding P-450 species.

As discussed above, SA protects the cells from highly violent HO[•], therefore, the involvement of HO[•] in SA signal transduction could be eliminated (Kawano and Muto, 2000) if the SA-HO[•] byproducts are all inert. Recently, we have reported that 2,3- and 2,5-DHBAs, two major products of SA-HO[•] reaction (totally *ca.* 90% of byproducts), as to have strong activity in induction of O₂^{•-} generation in tobacco cell culture (Kawano *et al.*, 2004a). This implies that SA actively sacrifices itself for the elimination of HO[•] without any loss of O₂^{•-} generation. Since the presence of SA does not allow

the retention of HO[•], we propose that SA-induced O₂^{•-} and derived ROS such as H₂O₂ (but not HO[•]) function downstream of SA. Here, catechol is also likely released from 10 % of SA that reacted with HO[•] (Fig. 5 b). If the *NahG*-based production of catechol may affect the SA action, as discussed above, it is interesting to examine if the HO[•]-dependent conversion of SA to catechol has some impact or not.

3.3 Peroxidative SA degradation

A group of pioneering researchers of peroxidase in Geneva metaphorically described that plant peroxidases possess more functions than a ‘Swiss army knife’ (Passardi *et al.*, 2005). Indeed, highly diversified functions of plant peroxidases including regulation of H₂O₂ level, oxidation of various substrates, generation of ROS (coupled to oxidation of indole-3-acetic acid, amines and SA) have been reported to date (Kawano, 2003). In plants, peroxidases achieve a great deal of oxidation reactions essential for the cells, using H₂O₂ as an electron (e⁻) acceptor and a variety of substrates as an e⁻ donors (Penel, 2000). By synthesizing or inducing certain isoforms of peroxidase at specific timing and localization, thus by making use of a variety of plant peroxidase functions, the living plants can respond to and combat a variety of biotic and abiotic stimuli threatening the plants (Hiraga *et al.*, 2001; Penel *et al.*, 1992). Oxidation of SA is one of the key functions of the ‘knife’ (Passardi *et al.*, 2005). In Fig. 5c, byproducts of peroxidase-catalyzed oxidation of SA coupled to the generation of O₂^{•-} are shown, and possible overall interactions between SA and plant peroxidases are summarized in Fig. 6. As proposed earlier (Kawano *et al.*, 1998; Kawano and Muto, 2000), estimated reactions for the generation of O₂^{•-} are as follows:

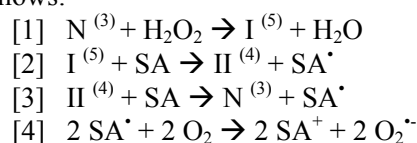

where N, I, II are native ferric peroxidase and its Compounds I and II, respectively. SA[•] and SA⁺ are free radical species and the two-electron oxidized intermediate products, respectively. Numbers in the small brackets indicate the formal oxidation states of the heme. Here, SA behaves as the e⁻ donor while H₂O₂ acts as the e⁻ acceptor. Then the released SA[•] may react with O₂ to form O₂^{•-}. As O₂^{•-} can be readily converted to H₂O₂, one cycle of SA-oxidizing peroxidase reaction started with single unit of H₂O₂ results in the yield of two units of O₂^{•-} equivalent to two units of H₂O₂, thus ROS members are amplified. Other possible consequence of SA[•] formation may

be induction of lipid peroxidation that enhances the SA-induced *PR-1* gene expression in plants (Anderson *et al.*, 1998).

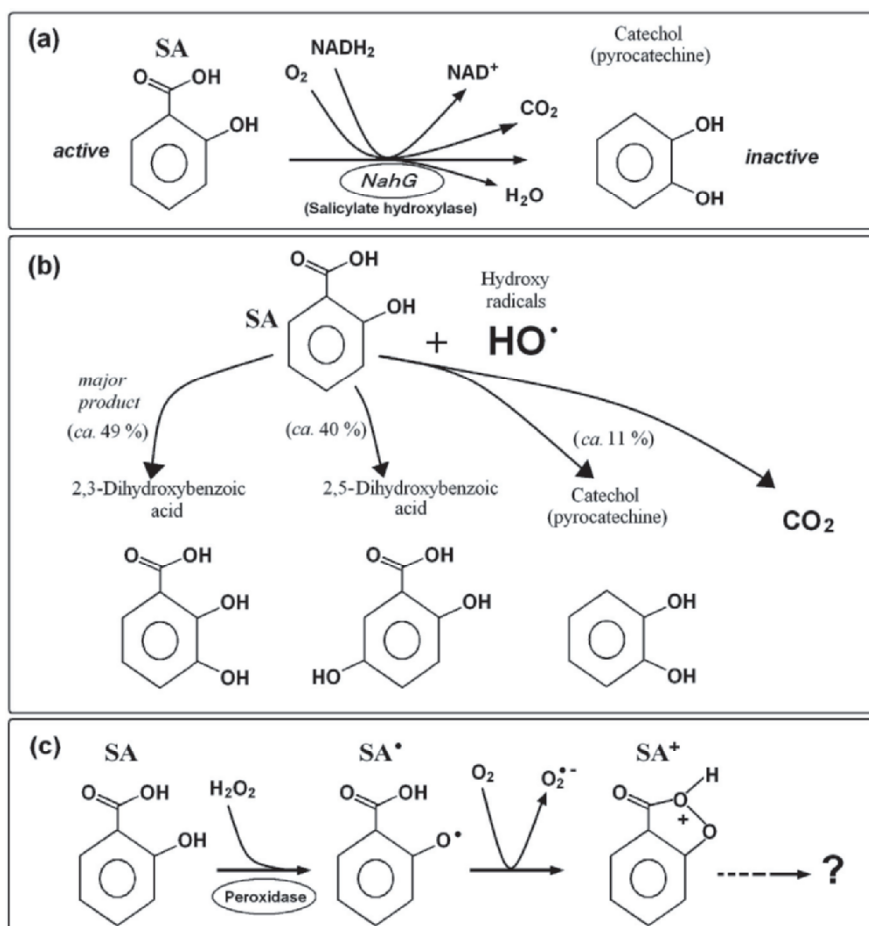

Figure 5. Possible oxidative degradation of SA via three different mechanisms. (a) NahG-dependent degradation of SA. Salicylate hydroxylase encoded by NahG gene catalyzes the production of catechol from SA. (b) Hydroxy radical-dependent oxidation of SA. SA is one of the strongest scavengers for HO^\bullet , as the HO^\bullet removal activity of SA in tobacco cell culture was demonstrated with electron spin resonance spectroscopy (Kawano and Muto, 2000). The likely products due to SA- HO^\bullet interaction are shown. Numbers in the brackets indicate the probable rate of yield (Halliwell *et al.*, 1991). (c) Possible peroxidase-catalyzed reaction leading to oxidative degradation of SA and generation of $\text{O}_2^{\bullet-}$ proposed by Kawano and Muto (2000). The structures of SA^\bullet and SA^+ proposed by Gozzo (2003) are shown. There may be alternative structures for SA^\bullet and SA^+ (e.g., radical could be localized at the carboxylic moiety too).

Experimental evidence in support of the production of SA[•] species has been obtained from an ESR study using ascorbate as a sensitive spin trapper (Kawano and Muto, 2000). The likely structures of SA[•] and SA⁺ shown in Fig. 5c were proposed by an Italian scientist (Gozzo, 2003) after our earlier studies. Effect of SA on the peroxidase oxidation state was carefully examined through spectroscopic analysis using horseradish peroxidase (HRP) as a model enzyme (Kawano *et al.*, 2002a,b) and the two-ring model, presented in Fig. 6, was proposed.

The reactions in the oxidase cycle (Fig. 6, right) can be attributed to the chemistry of heme thus common to most of heme proteins including hemoglobins, while the peroxidase cycle (Fig. 6, left) involves Compound I in which the localization of second radical differs in different protein species (it can be on the hemes or amino acid residues). This variation may contribute to the diversity of reactions catalyzed by each protein.

Compound III (formal oxidation state, 6) is the temporally inactive peroxidase intermediate (-Fe^{II}-O₂) which is analogous to oxygen-bound hemoglobin (-Fe^{II}-O₂) that release ROS when auto-oxidized to met-hemoglobin, a ferric protein which is highly analogous to native peroxidase (Alayash 1999; Kawano *et al.*, 2002c). When the heme and oxygen dissociate from Compound III, O₂^{•-} and the native enzyme are released. Most heme proteins including French bean peroxidase are capable of generating H₂O₂ (derived from O₂^{•-}) at higher pH by a mechanism that involves the formation of Compound III (Bolwell *et al.*, 2002), thus very much different from the SA-dependent oxidative burst. Compound III is likely formed from native peroxidase in the presence of O₂^{•-} (-Fe^{III} + O₂^{•-} → -Fe^{II}-O₂, -Fe^{III}-O₂^{•-}), and by forming Compound III, peroxidase can also be somehow inactivated in the presence of high concentrations of H₂O₂ (Kawano *et al.*, 2002a,d). The formation of Compound III from the native enzyme in the presence of ROS, therefore, mimics the reverse pathway of hemoglobin auto-oxidation. Typical feedback inactivation of peroxidase by peroxidase-mediated production of high concentration of H₂O₂, reported for many plant peroxidases (Barcelo, 1999), might be attributed to this mechanism. This temporal inactive form is further converted to a heme catabolite, known as P-670 in the presence of SA, when examined with HRP (Kawano *et al.*, 2002a), indicating that SA irreversibly inactivates the protein when the condition matches. The SA-dependent peroxidase inactivation may be a possible explanation for the short-lasting nature of peroxidase-dependent ROS production in SA-treated tobacco cell culture (Kawano and Muto, 2000).

The missing pieces in the oxidase cycle are the reducing agents that convert native ferric enzyme (-Fe^{III}) to ferrous enzyme (-Fe^{II}). Probably this reaction is the key step for supporting the Compound III-dependent O₂^{•-}

generation. This topic has been fully discussed in our previous review article, by naming possible reducing agents likely present in the plants developing the defense responses (Kawano *et al.*, 2004b).

3.4 Peroxidase activity and calcium

Since peroxidase-dependent oxidation of SA in the apoplast has been shown, the behavior of peroxidase in the apoplast must be understood. In the apoplastic spaces, ROS metabolism by peroxidases are highly regulated by the presence of Ca^{2+} since the secretion of peroxidases by plant cells reportedly requires the presence of extracellular Ca^{2+} (Sticher *et al.* 1981). Many apoplastic peroxidases are presumed to be bound to the cell wall by binding to polygalacturonate chains in the Ca^{2+} -induced conformation (Carpin *et al.* 2001). Recently, such a Ca^{2+} -pectate binding peroxidase has been recognized among *A. thaliana* peroxidases (Shah *et al.* 2004). Therefore, the cell wall-bound calcium plays an important role in the regulation of ROS metabolism.

Direct regulation of peroxidase activity by binding of free Ca^{2+} to its protein is also known. Recently, it has been shown that two calcium ions are normally bound to each plant peroxidases (many being secretory peroxidases) and appear to be important for the catalytic efficiency (Longu *et al.* 2004). Such Ca^{2+} -binding peroxidases include HRP (Howes *et al.* 2001, Laberge *et al.* 2003) and *Euphorbia characias* latex peroxidase (ELP) (Medda *et al.* 2003). In case of ELP, excess of Ca^{2+} added to the native purified enzyme enhances the catalytic efficiency by 3 orders of magnitude (Medda *et al.* 2003). The suggested mechanism for enzyme activation tells us that the main effect of Ca^{2+} is to favor the oxidation of native enzyme by H_2O_2 to form Compound I, whereas other steps of the catalytic cycle seem to be affected to a lesser extent.

Calmodulin (CaM) is a ubiquitous Ca^{2+} sensor found in all eukaryotes. Since Muto and Miyachi (1977) discovered the presence of CaM, the first calcium-binding protein found in plants, from pea seedlings, a growing number of CaM-related proteins have been identified in plants. Interestingly, through the study of ELP, Mura *et al.* (2005) provided the first example of the Ca^{2+} /CaM-activated peroxidase that may form a piece in the orchestrated plant defenses against biotic and abiotic stresses, by tuning the interaction between calcium signaling cascade and H_2O_2 metabolism.

The peroxidase-catalyzed metabolisms of ROS include not only degradation of H_2O_2 but also generation of other ROS such as $\text{O}_2^{\cdot-}$ as discussed above. It is tempting to speculate that SA-induced oxidative burst which requires the formation of Compound I as the initial event may be regulated by the presence of Ca^{2+} too.

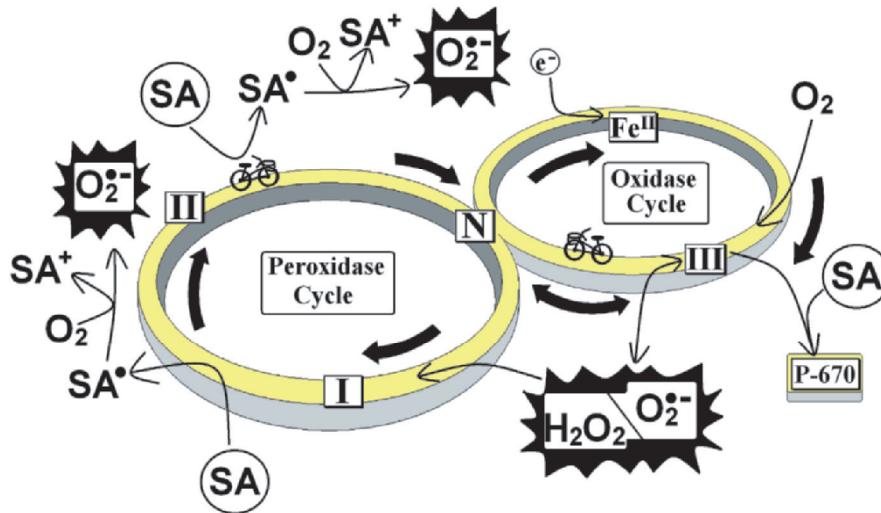

Figure 6. Involvement of SA in the ROS-generating and metabolizing peroxidase reactions. Interrelationship among five redox states of peroxidase and P-670 pigment are illustrated. N, I, II, III, and Fe^{II} stand for native enzyme, Compounds I, II, III, and ferrous enzyme intermediate, respectively. Reaction paths in the left circle (N → I → II → III → N) indicate the normal peroxidative catalytic cycle of the enzyme.

4. ROS AND CALCIUM

4.1 ROS triggers calcium influx

As discussed above, numbers of studies have indicated that SA is an oxidative signal inducer which is essentially involved in development of SAR against various pathogens with various natures. However, our knowledge on the oxidative SA signal transduction mechanism is limited. It has been proposed that SA signal transduction leading to SAR may be mediated by ROS derived from H₂O₂, since SA binds and inhibits catalase (Chen *et al.*, 1993b). After the catalase inhibition model proposed in early '90s which is a passive mechanism supporting the increases in ROS, an active mechanism involving peroxidase that directly generates ROS in response to SA has been reported in late '90s as discussed below. In addition to ROS, Ca²⁺ is another possible mediator of SA signals, and certain number of reports indicated that Ca²⁺ is essential for the action of SA during plant defense, since Ca²⁺ plays key roles as a secondary messenger for certain processes in plant defense mechanisms (Knight *et al.*, 1991; Sanders *et al.*, 1999). For instance, removal of Ca²⁺ or blockade of Ca²⁺ uptake inhibits the

induction of SA-inducible chitinase accumulation in tobacco cells and leaves (Raz and Fluhr, 1992), and carrot cell culture (Schneider-Müller *et al.*, 1994).

The first report connecting the SA-induced ROS (especially $O_2^{\cdot-}$) and the SA-induced increase in $[Ca^{2+}]_c$ in SA signaling, documented the experiments using aequorin-expressing tobacco BY-2 cells (Kawano *et al.*, 1998). Treatment of tobacco BY-2 cells with sub-mM order of SA resulted in rapid and transient generation of $O_2^{\cdot-}$ monitored with a specific chemiluminescence of a *Cypridina* luciferin analog, and also a transient increase in $[Ca^{2+}]_c$ (detected with aequorin luminescence). There, $O_2^{\cdot-}$ likely triggers the influx of Ca^{2+} into the cells and this view was supported by the tests using various inhibitors of ROS and calcium signaling. Our previous works (Kawano *et al.*, 1998; Kawano and Muto, 2000) have revealed that the SA-induced extracellular oxidative burst (generation of $O_2^{\cdot-}$) is catalyzed by extracellular free and cell wall-bound peroxidases (Fig. 6).

According to calculations, the production of $O_2^{\cdot-}$ and H_2O_2 induced by 0.5 mM SA was estimated to be *ca.* 2.5 and 10 nmoles/ml culture, respectively; and the maximal $[Ca^{2+}]_c$ attained after the addition of 0.5 mM SA was estimated to be *ca.* 600 nM (Kawano and Muto, 2000).

4.2 SA and ROS-responsive calcium channels

Action of SA, mediated by cell wall peroxidase-dependent ROS production and Ca^{2+} influx was also observed in *Vicia faba* epidermis (Mori *et al.*, 2001). Addition of SA (Manthe *et al.*, 1992; Lee, 1998) and the SA-induced $O_2^{\cdot-}$ and the chemically generated $O_2^{\cdot-}$ (Mori *et al.*, 2001) were shown to induce closure of stomata, which is known as a Ca^{2+} -dependent event (Hedrich *et al.*, 1990; Fell *et al.*, 2000).

With great similarity to SA signaling models, plant responses to abscisic acid (ABA) such as stomatal closure, involve ROS production (Apel and Hirt, 2004) and Ca^{2+} influx (Hetherington and Brownlee, 2004). Recent studies revealed that ABA action in guard cells is mediated with the generation of ROS by NADPH oxidase followed by activation of voltage-dependent Ca^{2+} -permeable channel (Pei *et al.*, 2000; Murata *et al.*, 2001). In the proposed model, ABA elicits the production of H_2O_2 and in turn, H_2O_2 stimulates the opening of Ca^{2+} channel(s), resulting in a rapid increase in $[Ca^{2+}]_c$ (Mori and Schroeder, 2004). However, the Ca^{2+} channel(s) responsible for ABA-stimulated (and ROS-dependent) Ca^{2+} current has not been identified.

It is obvious that Ca^{2+} -permeable channels are the key entry points for Ca^{2+} into the cytosolic space, and for initiation of Ca^{2+} signaling since Ca^{2+} -binding eventually modulates the catalytic activities and substrate affinities

of many enzymes and related factors (Sanders *et al.*, 2002). Voltage-dependent Ca^{2+} -permeable channels (VDCCs) play some important roles in signal transmission in the nerves and muscular contraction in animals. In plants, the importance of VDCCs was implied by many of the early works and their presence in plasma and endo-membranes was proven by electrophysiological analyses using patch clamp technique, although the molecular identification of VDCCs remained elusive until recently (White *et al.* 2002). To overview the plant Ca^{2+} signaling networks, the properties of the major groups of plant Ca^{2+} -permeable channels in *A. thaliana* encoded by 41 genes have been surveyed in recent years (Hetherington and Brownlee, 2004). At molecular level, the channels reported to date likely belong to either of cNMP-gated channel (*CNGC*) family, ionotropic glutamate receptor (*iGluR*) family, or two-pore channel 1 (*TPC1*) family.

Muto and his colleagues have made intensive efforts for the isolation of the cDNAs encoding for VDCC by expressing clones from a cDNA library of *A. thaliana* in the yeast *cch1* and *mid1* strains. Although this approach was not successful, a candidate of VDCC in plants, *AtTPC1* was finally isolated by the thorough search of the genomic sequence of *A. thaliana* using 30-60 bp degenerated sequences from the partial amino acid sequences of several VDCCs in animal cells as the queries and its Ca^{2+} -permeability was tested in a *cch1* strain (Furuichi *et al.* 2001). The newly isolated channel from *A. thaliana* has two conserved homologous domains termed Shaker-units, each domain consisting of six *trans*-membrane segments (S1-S6) and a pore loop (P) between S5 and S6, having the highest homology with the two pore channel (*TPC1*) cloned from rat (Ishibashi *et al.*, 2000), thus designated as *AtTPC1*. The overall structure is similar to the half of the general structure of α -subunits of voltage-activated Ca^{2+} channels. Notably, *TPC1* family is the most likely group of VDCCs involved in ROS-responses assuming the well conserved negatively charged residues within the voltage-sensor (S4 of Shaker-units) are responsive to ROS-dependent voltage changes. Sense-antisense experiments in *A. thaliana* and complementation tests in a Ca^{2+} uptake-defective yeast mutant have confirmed that *AtTPC1* might be functioning as a VDCC (Furuichi *et al.*, 2001).

Recently, some orthologs of *AtTPC1*, belonging to the plant *TPC1* family were isolated from tobacco (Kadota *et al.* 2004) and rice (Hashimoto *et al.* 2004, Kurusu *et al.* 2004), and not only predicted (White *et al.* 2002) but also demonstrated to exist in some other plant species such as corn, broad bean, pea, spinach and turnip (Furuichi, unpublished results). In *A. thaliana* and rice, such genes exist as single copy genes in the genome and are expressed in the entire plant body suggesting their systemic roles (Furuichi *et al.* 2001, Kurusu *et al.* 2004). In tobacco BY-2 cultured cell line, there are two copies of genes with high similarity (97.1% identity) with slightly

different molecular masses (Kadota *et al.* 2004), apparently detectable with the specific antibody against *AtTPCI* (Furuichi, unpublished result).

Although Kawano *et al.* (2004c) has reported the localization of *AtTPCI* fused with GFP at the plasma membrane when expressed in tobacco BY-2 cells, recent report by Peiter *et al.* (2005) suggested that *AtTPCI* is also localized to the vacuolar membrane and the vacuolar *TPCI* channel that might participate in Ca^{2+} -induced Ca^{2+} -release by behaving as a slow-vacuolar (SV) channel. However, *AtTPCI* expressed in yeast cells was shown to be inactivated by Ca^{2+} (unpublished result), thus it is indicative that the channel activity of *AtTPCI* is regulated by at least two different mechanisms.

Recently, our group conducted a series of over-expression and co-suppression experiments using transgenic cell lines of tobacco BY-2 cells transformed with the *AtTPCI*-encoding vector construct, and demonstrated that plant *TPCI* channels are key ROS-responsive Ca^{2+} channels (Kawano *et al.*, 2004c) and the channel-stimulating ROS includes $\text{O}_2^{\cdot-}$ and H_2O_2 (Kawano *et al.*, 2003). In addition, it has also been shown that Al^{3+} may be a novel channel blocker specific for ROS-responsive Ca^{2+} influx (Kawano *et al.*, 2003) mediated by *TPCI* channels (Kawano *et al.*, 2004c), suggesting that Al^{3+} can be a useful tool to study the role of ROS-responsive *TPCI* Ca^{2+} channels. Since the use of Al^{3+} enables the dissection of *TPCI*-mediated ROS-responsive Ca^{2+} influx, stimulated by other stimuli such as the mechano-sensitive nonselective cation channel-mediated osmotic stress-responsive Ca^{2+} influx, involvement of plant *TPCI* channels in SA-induced and ROS-mediated Ca^{2+} influx in plant cells was tested. The inhibitory effect of Al^{3+} as a putative and selective blocker of *TPCI* channels, clearly confirmed the involvement of *TPCI* type channels in the SA-induced Ca^{2+} influx in tobacco BY-2 cells (Lin *et al.*, 2005). In addition, loss of responsiveness to SA in inducing Ca^{2+} influx was confirmed in transgenic cell lines of *A. thaliana* (Furuichi, unpublished results). The roles of plant *TPCI* channels in overall SA signaling with regard to defense response against the pathogens remain to be determined.

4.3 Roles for CaM

A class of CaM specifically inducible by SA and HR-inducing treatment may be the possible mediators of SA-dependent Ca^{2+} signaling, initiated by TMV infection in tobacco (Yamakawa *et al.*, 2001). In soybean plants, expression of specific CaM isoforms (*SCaM-4* and *5*) among several *SCaM* genes were shown to be activated by pathogen attacks or pathogen-derived elicitors, and induction of *SCaM-4* and *5* was shown to be highly dependent on the increase in $[\text{Ca}^{2+}]_c$, thus they participate in Ca^{2+} -mediated disease

resistance responses (Heo *et al.*, 1999). Constitutive expression of these soybean CaMs in tobacco plants (thus not requiring inducing signal) reportedly results in the development of lesion and activation of SAR-associated genes without the requirement of SA (examined with *NahG* experiments). Assuming that these CaMs are SA-responsive, their involvement in SA-induced SAR is of our interest.

5. THE LINK BETWEEN OXIDATIVE BURST AND PROTEIN KINASE

5.1 SA-induced protein kinase (SIPK)

In tobacco plants, SA activates a protein kinase designated as SA-induced protein kinase (SIPK) (Zhang and Klessig, 1997) and activation of SIPK results in multiple defense responses (Zhang and Liu, 2001), and include SAR and late oxidative burst (Yang *et al.*, 2001; Ren *et al.*, 2002). In Fig. 7, SA-dependent rapid activation of SIPK in BY-2 tobacco cell suspension culture is shown. Here, protein kinase activity was detected using myelin basic protein as an artificial substrate for phosphorylation. Narrow range (0.4-0.6 mM) of SA treatment resulted in optimal activation of 48-kD protein kinase which is almost identical to SIPK. The range of SA concentrations preferred in BY-2 cells was much higher than that reported for tobacco cell culture derived from *N. tabacum* cv Xanthi (Zhang and Klessig, 1997).

In general SIPK may be responsive to various ROS, including ozone (Samuel *et al.*, 2005a) and H₂O₂ (Kawano *et al.*, 2004a). Our recent data suggested that H₂O₂ may not be a good intermediate activator of SIPK, since activation of the 48-kD protein kinase was detectable only when excess of H₂O₂ was added (Kawano *et al.*, 2004a). This is consistent with the studies showing that a MAP kinase counterpart (a homolog of SIPK) in *A. thaliana*, *ATMOK6* is responsive only to a notably high range of H₂O₂ concentration (1-10 mM) (Yuasa *et al.*, 2001; Gupta and Luan, 2003). Therefore, other ROS such as O₂⁻ may be the actual inducer of SIPK.

Studies have shown that a mitogen-activated protein kinase (MAPK) cascade controls multiple defense responses against pathogen invasion and the activation of MAPKs is one of the early responses in plants challenged by avirulent pathogens or the cells treated with pathogen-derived elicitors (Yang *et al.*, 2001). It has been proposed that MAPK cascades regulate hypersensitive response (HR) which is a form of programmed cell death often associated with plant disease resistance. Recent demonstration showed

that *NtMEK2*, a tobacco MAPK kinase, functions at the upstream of SIPK and wounding-induced protein kinase (WIPK), both activated by various pathogens or pathogen-derived elicitors (Yang *et al.*, 2001).

On many occasions, in plant responses to biotic and abiotic stresses, including plant-microbe interactions, NADPH oxidases (respiratory burst oxidase homologs, rboh) are involved in burst of ROS production. Plants actually respond to SA by inducing rboh-dependent oxidative burst (Yoshioka *et al.*, 2001b). Such rboh-dependent bursts in ROS production induced by SA is likely a late response compared to SA-induced immediate generation of ROS involving extracellular peroxidase that further triggers rapid changes in $[Ca^{2+}]_c$ (Kawano *et al.*, 1998; Kawano and Muto, 2000), indicating that there are two temporary distinct phases of oxidative bursts.

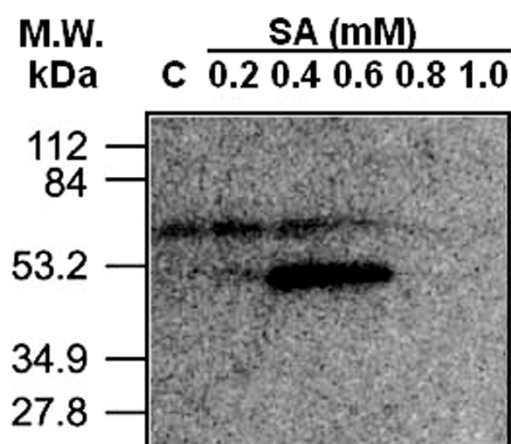

Figure 7. SA-dependent activation of SIPK in tobacco BY-2 cells. SIPK activity in tobacco cell culture was assayed with an 'in-gel' kinase assay using myelin basic protein (MBP) as a substrate. Tobacco cells were subjected to SA for 5 min.

Considering ROS production as the outcome rather than the cause of MAPK stimulation, the MAPK cascade and ROS production has been successfully linked through a series of studies using potato genes. It has been shown that transcript accumulations of two rboh isogenes of potato designated as *StrbohA* and *B* are sensitive to pharmacological inhibitors of protein kinases but not affected by inhibitors of Ca^{2+} influx, suggesting that certain Ca^{2+} -independent protein kinase such as SIPK may be involved in the induction of gene expression (Yoshioka *et al.*, 2001b). An over-expression experiment showed that increases in SIPK activity and ROS-mediated cell death were observed in *Nicotiana benthamiana* plants expressing constitutively active form of a genetically engineered potato ortholog of MAP kinase kinase (*StMEK1*) which phosphorylates and activates a potato SIPK ortholog (*StMPK1*) (Katou *et al.*, 2003).

Increase in ROS production and cell death in the above condition were shown to be due to induction of a *NbrbohB*, since silencing of this gene negates the action of constitutive *StMEK1* (Yoshioka *et al.*, 2003).

In contrast to the proposed pro-oxidative role for SIPK, a negative role of SIPK in ROS accumulation in response to harpin in tobacco plants and an elicitor from *Pseudomonas syringae* pv. *phaseolocola* (HrpZ) was also reported (Samuel *et al.*, 2005b). When tobacco plants are treated with harpin, a rapid cell death that involves multiple signaling components such as SA, ROS and MAPK, is induced. In genetically engineered plants lacking SIPK expression, both the sensitivity to harpin (cell death) and ROS level considerably increased. In the plants over-expressing SIPK, sensitivity to harpin and ROS level were lowered. This study reports the case in which the harpin-induced ROS behaves as the cause, rather than the outcome of SIPK activation, suggesting the presence of multiple paths for SIPK activation and SIPK functions.

5.2 Negative regulations

MAPK phosphatases are negative regulators of MAPKs. Recently, an Arabidopsis MAPK phosphatase, MKP1, was reported to be critical for inactivation of SIPK (Ulm *et al.* 2002). A MKP1 ortholog identified in tobacco, NtMKP1 has been reported as a CaM-binding protein (Yamakawa *et al.*, 2004). However, Katou *et al.* (2005) has demonstrated that, despite of affinity to CaM, binding to CaM plays no regulatory role in phosphatase activity. Instead its role as a SIPK inactivating enzyme which acts through dephosphorylation of TEY motif of SIPK, was confirmed. N-terminal noncatalytic region of NtMKP1 was shown to be essential for binding to SIPK. Interestingly, phosphatase activity of NtMKP1 was shown to be highly increased upon binding to SIPK. Thus, SIPK-dependent activation without requirement for CaM may be important to the function of NtMKP1 in plants.

SIPK-dependent negative feedback against SA accumulation is known. During plants' response to ozone in the atmosphere, the ozone-induced SIPK play a key roles by enhancing the ozone-induced ethylene biosynthesis. However, ozone-responsive SA accumulation was shown to be blocked by over-expression of SIPK that enhances the ozone-induced cell death. This suggests that SIPK presented in excess (thus excess of SA-dependent signal) may function as a negative feedback point that lowers the SA biosynthesis (Samuel *et al.*, 2005a).

6. REGULATION OF GENE EXPRESSION

6.1 Redox signaling and *NIM1/NPRI*

With genetic approaches, several groups have made intensive efforts for revealing SA signal transduction pathways by analyzing the number of Arabidopsis mutants lacking responses to SA and SA analogs. The fruits of their continuous works were isolation and characterization of mutants designated as *nim1* (*non-inducible immunity 1*, see Delaney *et al.*, 1995), *npr1* (*nonexpresser of PR genes*, see Cao *et al.*, 1994), and *sail* (*salicylic acid insensitive 1*, see Shah *et al.*, 1997). These mutants were all insensitive to SA, INA and BTH, and shown to involve the same gene which is now called *NIM1* or *NPRI*.

In the SA signaling pathway, *NPRI* plays a central role in the activation of defense-related genes by enhancing the binding of transcription factors belonging to TGA subclass of the basic leucine zipper family (TGAs) to SA-responsive elements in the promoter regions of PR genes (Zhang *et al.*, 1999; Fobert and Després, 2005). First genetic evidence on the *NPRI-TGA* interaction in plants was obtained from the experiments that reproduced the *npr1* mutant-like phenotype by expressing the truncated form of *TGA2* in Arabidopsis (Fan and Dong, 2002). According to the model of *NPRI* activation proposed by Mou *et al.* (2003), SA-induced changes in cellular redox status may trigger the conformational changes of *NPRI* protein since *NPRI* proteins from various plant species share the conserved Cys residues (sensitive to redox changes) capable of forming both intra- and intermolecular disulfide bonding and replacement of these Cys residues with other amino acids reproduced the mutant *npr1*-like phenotype. In addition, SA-mediated changes in redox status upon induction of SAR, reduces the Cys residues of *TGA1* too (Després *et al.*, 2003). Only after reduction of disulfide bonds to free Cys residues, *TGA1* is capable to interact with *NPRI*. However, the identity of the redox mediators or the mechanism of SA-dependent changes in cellular redox status is still unclear (Fobert and Després, 2005).

Assuming that the ROS produced in response to SA may induce or activate the anti-oxidative mechanisms forcing the cellular redox conditions back to reductive state, the SA-induced oxidative burst and subsequently activated enzymes for removing ROS may have great impact on cellular redox changes that are required for *NPRI* activation (Mou *et al.*, 2003).

Recently, involvement of *NPRI* in the cross-talk between SA signaling paths and jasmonic acid (JA) signaling paths has been elucidated. Both SA and JA function in SAR signaling and disease defense accompanying with

their cooperative and antagonistical interactions (Turner *et al.*, 2002, Kunkel and Brooks, 2002). For instance, it has been reported that JA and SA induce expression of PR-genes through antagonistical interactions (Niki *et al.*, 1998). Interestingly, induction of acidic PR gene expression by SA and that of basic PR gene expression by JA could be inhibited in the presence of JA and SA, respectively (Niki *et al.*, 1998).

Recent studies suggested that SA-dependent inhibition of JA action (lowered induction of JA-responsive genes) could be manifested *via* the activation of *NPR1* (Pieterse and van Loon, 2004).

In addition to its crucial role in the regulation of SA-responsive PR gene expression by shuttling into nucleus from the cytoplasm, *NPR1* was shown to act within cytoplasm for participating the crosstalk between SA and JA. Activation of SA-mediated SAR suppresses JA signaling, and as a consequence the SA-dependent resistance takes priority over JA-dependent defenses. According to Spoel *et al.* (2003), antagonistic effect of SA on JA-responsive gene expression is negatively regulated by SA-activated *NPR1* while nuclear localization of *NPR1* appeared to be unnecessary for opposing the JA action. Although the mode of *NRR1* action in the inhibition of JA-responsive gene expression is still unknown, Pieterse and van Loon (2004) have proposed that cytosolic *NPR1* interferes with the SFC^{COI1} ubiquitin-ligase complex that plays a key role in JA response (Xu *et al.*, 2002; Devoto *et al.*, 2002).

It is enigmatic that SA accumulation is reportedly higher in pathogen-inoculated *npr1* mutants than in wild-type plants similarly inoculated with pathogen (Shah *et al.*, 1997; Delaney *et al.*, 1995). In addition, SA accumulation in several lesion-mimic mutants is higher in the *npr1* background than in the *NPR1* wild-type background (Clarke *et al.*, 2000; Shah *et al.*, 1999). As an answer to this problem, a negative feedback model in which *SID2* expression in pathogen-infected plants is lowered by *NPR1*, has been proposed after observation that the expression of *SID2* was greater in pathogen-inoculated *npr1* plants than in wild-type plants (Wildermuth *et al.*, 2001).

6.2 Early genes and late genes

In this section, *NPR1*-dependent and independent regulation of gene expressions are discussed. It has been shown that expression of certain genes can be rapidly induced by SA and pathogens. Such genes include *A. thaliana* glutathione *S*-transferase genes and glucosyltransferase gene (Lieberherr *et al.*, 2003; Uquillas *et al.*, 2004). According to Uquillas *et al.* (2004), immediate induction of such early genes by SA proceeds through an *NPR1*-independent pathway while SA-induced activation of late defense genes

such as *PR-1* involves the participation of *NPR1* protein. Temporally distinct phases of oxidative bursts (namely, early peroxidase-dependent and late rboh-dependent bursts) and gene expression events (early genes and late defense genes) likely suggest temporary different modes of SA action. As suggested in case of *NPR1* (Mou *et al.*, 2003; Després *et al.*, 2003), redox changes due to oxidative burst may contribute to the late defense gene activation. It is reasonable to assume that the early gene expression requires the earlier SA signaling mechanism other than late oxidative burst and *NPR1* involvement. The immediate oxidative burst (production of ROS) followed by Ca^{2+} movement or alternative ROS-independent early protein kinase activation event may form the possible signaling pathways corresponding to early gene activation.

An earlier study showed that early transcription activation by SA examined in transgenic tobacco plants carrying regulatory sequences derived from CaMV 35S promoter involves the activation of SA-responsive element known as *activation sequence-1 (as-1)*, and this immediate activation proceeds even in the presence of cycloheximide while the SA-induced transcription of PR-genes (late genes) was shown to be sensitive to cycloheximide treatment (Qin *et al.*, 1994).

On the other hand, the *as-1* element is responsive to auxin too (Garreton *et al.*, 2002). Natural auxin indole-3-acetic acid reportedly induces ROS production in some plant cultures (Pfeiffer and Hoftinger, 2001) and also during certain types of plant peroxidase reactions (Kawano *et al.*, 2001). The likely intermediate signal for the activation of *as-1* element by SA or auxin is ROS, although the modes of peroxidase reactions involving auxin are largely differed from SA-related reactions (Kawano, 2003).

In the induction of gene expression in tobacco plants, SA targets *as-1*-like promoter element found in some redox-related genes such as several glutathione *S*-transferase genes, through the induction of oxidative burst (Garreton *et al.*, 2002). However, involvement of H_2O_2 was eliminated since treatment with H_2O_2 and/or 3-amino-1,2,5-triazole which is considered to mimic the action of SA by inhibiting catalase, resulting in no activation of *as-1*-dependent gene expression, and instead, the inhibitor strongly inhibited the action of SA in the induction of *as-1*-regulated gene expression (Garreton *et al.*, 2002). Therefore, involvement of other ROS such as $\text{O}_2^{\cdot-}$ may have specific role distinct from that of H_2O_2 .

Interestingly, regarding expression of *PR-1*, a late gene, in Arabidopsis the *NPR1*-dependent path mediated with *TGAs* (*TGA2* and 3) also involves an *as-1*-type cis element called *LS7* (Johnson *et al.*, 2003). Therefore, the responses of *as-1*-type cis elements are not limited to the early gene inducing signaling but also to the late gene inducing signaling mechanism.

In addition, we would like to introduce a recent model for Ca^{2+} /CaM-dependent induction of SA-responsive genes, involving ROS (Fig. 8). Du and Poovaiah (2004) have reported a novel group of plant-specific CaM-binding proteins, designated as *AtBT1-5* (*A. thaliana* BTB and TAZ domain proteins) shown to be present in the nucleus and interacting with two transcriptional regulators belonging to *fsh/Ring3* class. Notably, all *AtBT* homologs are inducible by SA and H_2O_2 thus suggesting that the cascade of early SA action involving ROS and Ca^{2+} may affect the transcription through expression and conformational changes of these proteins.

6.3 Disease resistance (R) genes and SA

Disease resistance (R) genes in plants provide a major mode of defense against a wide variety of pathogens and pests (Ramakrishna *et al.*, 2002) and the genome of *A. thaliana* contains more than 120 NBS-LRR genes (Arabidopsis Genome Initiative, 2000). The most abundant class of R gene encodes proteins with a nucleotide-binding site (NBS) and a leucine-rich repeat (LRR) region. Functional analysis of the NBS-LRR genes suggested that the LRR region provides specificity for the recognition of a pathogen gene product, and thereby leads to the initiation of a signal transduction cascade that activates several defense pathways (Ellis *et al.*, 2000). It has been shown that activation of R-gene-mediated defense signaling induces SA biosynthesis and downstream defense responses. In turn, SA treatment activates the expression of the toll-interleukin-2 receptor (TIR)-NBS-LRR type R genes (Shirano *et al.*, 2002). A study on the gain-of-function mutation in a TIR-NBS-LRR-type R gene, *SSI4*, revealed that this R-gene activation is SA-dependent, but *NPR1*-independent in *A. thaliana ssi4* mutant (Shirano *et al.*, 2002).

SA activates the expression of *RPW8* genes. Two members of *A. thaliana* R genes, *RPW8.1* and *RPW8.2*, known to participate in the recognition of powdery mildew pathogens induce a localized necrosis or HR (Xiao *et al.*, 2001). This HR development likely requires the transcription of *RPW8.1* and *RPW8.2* positively regulated by SA-dependent feedback amplification (Xiao *et al.*, 2003). SA also activates the expression of the *EDS1* gene, which is required for SA accumulation and resistance conferred by these R-gene-activated pathways, indicating the SA-dependent positive feedback regulation of these R genes and of *EDS1* (Feys *et al.*, 2001). *EDS1* has a dual role in plant defense (Feys *et al.*, 2001). *EDS1* is required for HR development, and it is also required for SA accumulation, in association with *PAD4* gene. Expression of *EDS1* and *PAD4* is reportedly activated upon pathogen attacks and addition of BTH (Feys *et al.*, 2001). Furthermore, SA-stimulated expression of *EDS5* and *PAD4* genes results in enhancement of

SA biosynthesis via activation of *SID2* (Verberne *et al.*, 2000; Wildermuth *et al.*, 2001; Feys *et al.*, 2001). Above studies suggest that at multiple points SA exerts regulatory positive feedback effects for amplification of R gene actions. In a recent review, Shah (2003) propounded that activation of the expression of multiple R genes by SA could be a part of mechanisms that activates broad-spectrum resistance, and likewise a feedback mechanism may be important in amplifying plant defense responses.

7. OTHER SIGNALING TOPICS

7.1 Roles for SA-binding proteins

Klessig and his colleagues conducted a series of pioneering works on SA binding proteins (SABPs), putative SA receptors. There is no doubt that the search for SABPs provided several key ideas in SA biology such as involvement of ROS in the induced signal transduction.

To date, 3 types of SABPs have been isolated by this group. The first SABP isolated from tobacco was shown to be catalase (Chen *et al.*, 1993a,b, Conrath *et al.*, 1995). Since binding of SA to catalase resulted in the inhibition of H₂O₂ degradation, an idea that the increases in H₂O₂ and/or other ROS derived from H₂O₂ may be the key events acting at downstream of SA. The results with mammalian catalase also supported the likely SA action through catalase inhibition (Durner and Klessig, 1996). Similarly, Kawano *et al.* (1998) have observed the SA-dependent inhibition of catalase in suspension cultured tobacco cells *in vivo* by monitoring the H₂O₂-dependent evolution of O₂. However, significance of catalase inhibition in early SA action is uncertain.

Like catalase, extracellularly secreted peroxidases should be considered as a group of proteins having key interactions with SA leading to oxidative burst in early SA signal transduction as discussed in the earlier sections. However, we would like to exclude ascorbate peroxidase from the SA-signaling mediators. For discussion concerning the involvement of ascorbate peroxidase in SA biology, please refer to earlier publications with both positive views (Durner and Klessig, 1995) and negative views (Miyake *et al.*, 1996; Kvaratskhechia *et al.*, 1997; Tenhaken and Rubel, 1997; Kawano *et al.*, 1998, 2004b).

As stated above, SABP2 was also isolated from tobacco as a possible SA receptor (Du and Klessig, 1997) highly required for TMV-induced SAR development (Kumar and Klessig, 2003), and finally its roles as a SA-stimulated lipase (Kumar and Klessig, 2003) or a SAME esterase that

demethylates SAME to produce free SA, have been identified (Forouhar *et al.*, 2005).

Slaymaker *et al.* (2002) announced the isolation of third SABP from tobacco. SABP3 is identified as a chloroplast-targeted carbonic anhydrase that shows antioxidative activity when expressed in yeast. Since possible role of chloroplast as the site of SA biosynthesis is highlighted through the study of *A. thaliana sid2* mutant lacking the chloroplast-localized ICS enzyme (Wildermuth *et al.*, 2001), we can expect that a SABP specifically localized in chloroplasts may play some key roles. As Shah (2003) has predicted in his review that chloroplasts and plastids might be the source of signals affecting the response to pathogens, by analogy to the mitochondrial roles in mammals. Further continuous searches for the proteins of great importance directly governing the SA signal transduction by this group and other active researchers are expected.

7.2 Ca^{2+} and rboh

There are some plant NADPH oxidases, localized in the plasma membrane, of which the $\text{O}_2^{\cdot-}$ -generating activity is directly and positively regulated by Ca^{2+} (Sagi and Fluhr, 2001). It is possible that Ca^{2+} has a direct effect on the NADPH oxidase, since plant enzyme has an N-terminal sequence with two Ca^{2+} -binding EF-hand motifs (Keller *et al.*, 1998; Torres *et al.*, 1998). Therefore, SA-induced $[\text{Ca}^{2+}]_c$ elevation which is a downstream of SA-induced immediate oxidative burst may further contribute to the late oxidative burst catalyzed by rboh (Fig. 8.).

7.3 Electrical simulation of cellular signaling

In addition to biological approaches, Ken Yokawa, a researcher at Waseda University, Japan, is now developing a computational simulation for testing the impact of SA on calcium homeostasis by making use of a highly developed computer simulation system called “NEURON” which is commonly accepted and used for researches on neuronal activities and neuronal cell status, after designing the plant-specific parameters and constructing an artificial model plant cell *in silico* (Yokawa, 2005). In combination with the collections of cellular, biochemical and electrophysiological data, such computer simulations for describing and predicting the actions of plant hormones may be successful in the near future.

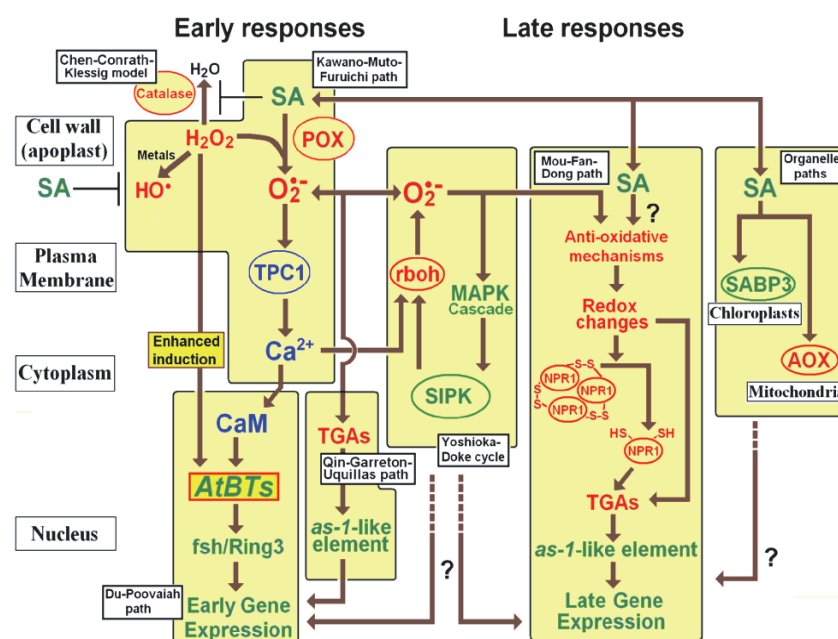

Figure 8. SA-dependent early and late gene expressions mediated with various signaling events. Redox-related signaling components and events were shown in red and calcium-related signaling components were shown in blue. Other SA-related events and components were shown in green.

8. CONCLUSION

In animals, the salicylates basically act through interactions with an oxidase (cyclooxygenase). Also in plants, in addition to binding to SABPs (*SABP2* and *3*), the actions of salicylates are likely manifested through interactions with various oxidases such as alternative oxidase, peroxidases, catalase and other hydroxylases involved in the generation and removal of ROS and signaling molecules. Recently the action of aspirin as a radical scavenger has been highlighted in animals. Such action of SA as remover of specific ROS (of HO[•]) was demonstrated in plants. The single key word best describing the nature of SA signaling may be 'redox' as many steps in the proposed signaling pathways require a variety of redox events.

Lastly, we would like to abstract the key signaling paths that lead to both early and late phases of gene expression, among the variety of reported biochemical events regarding SA signaling (Fig. 8). The early or immediate SA actions including catalase inhibition, HO[•] removal, generation of other

ROS ($O_2^{\cdot-}$ and H_2O_2) and stimulation of Ca^{2+} channel opening were covered as the upstream SA signaling mechanisms in the model. The early signaling events start from the lowering of H_2O_2 metabolism by catalase (Chen-Conrath-Klessig model) and making use of H_2O_2 for peroxidase-dependent $O_2^{\cdot-}$ generation (Kawano-Muto-Furuichi path). Generation of $O_2^{\cdot-}$ but not H_2O_2 may lead to the activation of *as-1*-like element-dependent gene expressions. Here, series of redox-regulated genes are activated (Qin-Garretton-Uquillas path). Calcium influx across the plasma membrane through the activation of *TPCI*-type channels may be stimulated by SA-induced $O_2^{\cdot-}$ (Kawano-Muto-Furuichi path). ROS- and Ca^{2+} /CaM-responsive mechanisms are activated and the early gene expressions are *AtBT-fsh/Ring3*-dependently activated (Du-Poovaiah path). One of the bridging paths between the early and late responses may be Yoshioka-Doke cycle in which oxidative burst may be amplified via cycle of $ROS/Ca^{2+} \rightarrow rboh \rightarrow O_2^{\cdot-} \rightarrow MAPK \text{ cascade} + SIPK \rightarrow rboh \rightarrow O_2^{\cdot-}$. SA-induced redox changes possibly due to activation of anti-oxidative enzymes may result in deligomerization of disulfide bond-dependently aggregated *NPR1*. The resultant monomeric *NPR1* may then target *TGA* transcription factors that interact with PR-gene promoters (Mou-Fan-Dong path).

Organelles such as chloroplasts and mitochondria may be the site of signal transmission too (Organelle paths). Although each model, cycle, or path was named after some researchers authoring key papers (except for organelle paths), the entire models are based on many of the important works reported by other researchers.

9. FURTHER READINGS

Readers are encouraged to access and read many of other excellent reviews on the action, signaling, and biosynthesis of SA, published in recent years (Christiane and Métraux, 2002; Métraux, 2002; Shah, 2003; Eckardt, 2003; Métraux and Durner, 2004; Singh *et al.*, 2004). Such reviews are covering newly updated knowledge including the recent discovery in SA biosynthetic pathways in *A. thaliana*. However, these articles are emphasizing the late responses leading to late gene expressions but not earlier signaling events involving rapid generation of ROS and calcium signaling. Therefore, in the present chapter, earlier signaling events leading to the rapid gene expressions are also deeply discussed to serve as a supplement to other review articles.

10. ACKNOWLEDGEMENT

This work is dedicated to the memory of the late Prof. Shoshi Muto.

11. REFERENCES

- Alayash, A. I., 1999. Hemoglobin-based blood substitutes: oxygen carriers, pressor agents, or oxidants?. *Nat. Biotechnol.*, **17**: 545-549.
- Alvarez, M. E., 2000. Salicylic acid in the machinery of hypersensitive cell death and disease resistance. *Plant Mol. Biol.*, **44**: 429-442.
- Anderson, M. D., Chen, Z., and Klessig, D. F., 1998. Possible involvement of lipid peroxidation in salicylic acid-mediated induction of PR-1 gene expression. *Phytochem.*, **47**: 555-566.
- Antoniw, J. F., and White, R. F., 1980. The effects of aspirin and polyacrylic acid on soluble leaf proteins and resistance to virus infection in five cultivars of tobacco. *Phytopath. Z.*, **98**: 331-341.
- Apel, K., and Hirt, H., 2004. Reactive oxygen species: metabolism, oxidative stress, and signal transduction. *Annu. Rev. Plant Biol.*, **55**: 373-399.
- Arabidopsis Genome Initiative, 2000. Analysis of the genome sequence of the flowering plant *Arabidopsis thaliana*. *Nature*, **408**: 796-815.
- Aubin, N., Curet, O., Deffois, A., and Carter, C., 1998. Aspirin and salicylate protect against MPTP-induced dopamine depletion in mice. *J. Neurochem.*, **71**: 1635-1642.
- Barcelo, A. R., 1999. *In situ* inactivation of the oxidase activity of xylem peroxidases by H₂O₂ in the H₂O₂-producing xylem of *Zinnia elegans*. *J. Plant Res.*, **112**: 383-390.
- Bolwell, G. P., Bindschedler, L. V., Blee, K. A., Butt, V. S., Davies, D. R., Gardner, S. L., Gerrish, C., and Minibayeva, F., 2002. The apoplastic oxidative burst in response to biotic stress in plants: a three-component system. *J. Exp. Bot.*, **53**: 1367-1376.
- Cao, H., Bowling, S. A., Gordon, A. S., and Dong, X., 1994. Characterization of an Arabidopsis mutant that is nonresponsive to inducers of systemic acquired resistance. *Plant Cell*, **6**: 1583-1592.
- Carpin, S., Crevecoeur, M., de Mayer, M., Simon, P., Greppin, H., and Penel, C., 2001. Identification of Ca²⁺-pectate binding site on an apoplastic peroxidase. *Plant Cell*, **13**: 511-520.
- Chen, H.-J., Hou, W.-C., Kuc, J., and Lin, Y.-H., 2001. Ca²⁺-dependent and Ca²⁺-independent excretion modes of salicylic acid in tobacco cell suspension culture. *J. Exp. Bot.* **52**: 1219-1226.
- Chen, H.-J., Hou, W.-C., Kuc, J., and Lin, Y.-H., 2002. Salicylic acid mediates alternative signal transduction pathways for pathogenesis-related acidic β -1,3-glucanase (protein N) induction in tobacco cell suspension culture. *J. Plant Physiol.*, **159**: 331-337.
- Chen, H.-J., and Kuc, J., 1999. Ca²⁺-dependent excretion of salicylic acid in tobacco cell suspension culture. *Botanic. Bul. Acad. Sinica*, **40**: 267-273.
- Chen, Z., Ricigliano, J. R., and Klessig, D. F., 1993a. Purification and characterization of soluble salicylic acid binding protein from tobacco. *Proc. Natl. Acad. Sci. USA.*, **90**: 9533-9537.
- Chen, Z., Silva, H., and Klessig, D. F., 1993b. Active oxygen species in the induction of plant systemic acquired resistance induced by salicylic acid. *Science*, **262**: 1883-1886.
- Christiane, N., and Métraux, J.-P., 2002. Towards the elucidation of the pathway leading to salicylic acid biosynthesis. *Biol. Plant-Microbe Interact.*, **3**: 64-71.

- Clarke, J. D., Volko, S.M., Ledford, H., Ausubel, F. M., and Dong, X., 2000. Roles of salicylic acid, jasmonic acid, and ethylene in *cpr*-induced resistance in *Arabidopsis*. *Plant Cell*, **12**: 2175-2190.
- Conrath, U., Chen, Z., Ricigliano, J. R., and Klessig, D. F., 1995. Two inducers of plant defense response, 2,6-dichloroisonicotinic acid and salicylic acid, inhibit catalase activities in tobacco. *Proc. Natl. Acad. Sci. USA.*, **92**: 7143-7147.
- Delaney, T. P., 2004. Salicylic acid, in: *Plant hormones. Biosynthesis, signal transduction, action!*, Davies, P. J. (Ed.) Kluwer Academic Publishers, Dordrecht, Boston, London, pp. 635-653.
- Delaney, T. P., Friedrich, L., and Ryals, J. A., 1995. Arabidopsis signal transduction mutant defective in chemically and biologically induced disease resistance. *Proc. Natl. Acad. Sci. USA.*, **92**: 6602-6606.
- Després, C., Chubak, C., Rochon, A., Clerck, R., Bethune, T., Desvieux, D., and Fobert, P. R., 2003. The Arabidopsis NPR1 disease resistance protein is a novel cofactor that confers redox regulation of DNA binding activity to the basic domain/leucine zipper transcription factor TGA1. *Plant Cell*, **15**: 2181-2191.
- Devoto, A., Nieto-Rosto, M., Xie, D. X., Dllis, C., Harmston, R., Patrick, E., Davis, J., Sherratt, L., Coleman, M., and Turner, J. G., 2002. COI1 links jasmonate signaling and fertility to the SCF ubiquitin-ligase complex in Arabidopsis. *Plant J.*, **32**: 457-466.
- Du, H. and Klessig, D. F., 1997. Identification of a soluble, high-affinity salicylic acid-binding protein in tobacco. *Plant Physiol.*, **113**: 1319-1327.
- Du, L., and Poovaiah, B. W., 2004. A novel family of Ca²⁺/calmodulin-binding protein involved in transcriptional regulation: Interaction with fsh/Ring3 class transcription activators. *Plant Mol. Biol.*, **54**: 549-569
- Durner, J., and Klessig, D. F., 1995. Inhibition of ascorbate peroxidase by salicylic acid and 2,6-dichloroisonicotinic acid, two inducers of plant defense responses. *Proc. Natl. Acad. Sci. USA.*, **92**: 11312-11316.
- Durner, J., and Klessig, D. F., 1996. Salicylic acid is a modulator of tobacco and mammalian catalases, *J. Biol. Chem.*, **272**: 28492-28501.
- Eckardt, N. E., 2003. A new twist on systemic acquired resistance: Redox control of the NPR1-TGA1 interaction by salicylic acid. *Plant Cell*, **15**: 1947-1949.
- Effmert, U., Saschenbrecker, S., Ross, J., Negre, F., Fraser, C. M., Noel, J. P., Dudareva, N., and Piechulla, B., 2005. Floral benzenoid carboxyl methyltransferases: from *in vitro* to *in planta* function. *Phytochem.*, **66**: 1211-1230.
- Ellis, J., Dodds, P., and Pryor, T., 2000. Structure, function and evolution of plant disease resistance genes. *Curr. Opin. Plant Biol.*, **3**: 278-284.
- Emoto, A., Ushigome, F., Koyabu, N., Kajiya, H., Okabe, K., Satoh, S., Tsukimori, K., Nakano, H., Ohtani, H., and Sawada, Y., 2002. H⁺-linked transport of salicylic acid, an NSAID, in the human trophoplast cell line BeWo. *Amer. J. Physiol.*, **282**: C1064-C1075.
- Enyedi, A. J., and Raskin, I., 1993. Induction of UDP-glucose:salicylic acid glucosyltransferase activity in tobacco mosaic virus-inoculated tobacco (*Nicotiana tabacum*) leaves. *Plant Physiol.*, **101**: 1375-1380.
- Enyedi, A. J., Yalpani, N., Silverman, P., and Raskin, I., 1992. Localization, conjugation, and function of salicylic acid in tobacco during the hypersensitive reaction to tobacco mosaic virus. *Proc. Natl. Acad. Sci. USA.*, **89**: 2480-2484.
- Fan, W., and Dong, X., 2002. *In vivo* interaction between NPR1 and transcription factor TGA2 leads to salicylic acid-mediated gene activation in Arabidopsis. *Plant Cell*, **14**: 1377-1389.
- Fell, H. H., Honstein, S., Steinmeyer, R., and Hedrich, R., 2000. Dynamics of ionic activities in the apoplast of the sub-stomatal cavity of intact *Vicia faba* leaves during stomatal closure evoked by ABA and darkness. *Plant J.*, **24**: 297-304.

- Feys, B. J., Moisan, L. J., Newman, M.-A., and Parker, J. E., 2001. Direct interaction between the *Arabidopsis* disease resistance signaling proteins, *EDS1* and *PAD4*. *EMBO J.*, **20**: 5400-5411.
- Fobert, P.R., and Després, C., 2005. Redox control of systemic acquired resistance. *Curr. Opin. Plant Biol.*, **8**: 378-382.
- Forouhar, F., Yang, Y., Kumar, D., Chen, Y., Fridman, E., Park, S. W., Chiang, Y., Acton, T. B., Montelione, G. T., Pichersky, E., Klessig, D. F., and Tong, L., 2005. Structural and biochemical studies identify tobacco SABP2 as a methyl salicylate esterase and implicate it in plant innate immunity. *Proc. Natl. Acad. Sci. USA.*, **102**: 1773-1778.
- Friedrich, L., Vernooij, B., Gaffney, T., Morse, A., and Ryals J., 1995. Characterization of tobacco plants expressing a bacterial salicylate hydroxylase gene. *Plant Mol Biol.*, **29**: 959-968.
- Fukami, H., Asakura, T., Hirano, H., Abe, K., Shimomura, K., and Yamakawa, T., 2002. Salicylic acid carboxyl methyltransferase induced in hairy root cultures of *Atropa belladonna* after treatment with exogenously added salicylic acid. *Plant Cell Physiol.*, **43**: 1054-1058.
- Furuichi, T., Cunningham, K. W., and Muto, S., 2001. A putative two pore channel *AtTPC1* mediates Ca^{2+} flux in *Arabidopsis* leaf cells. *Plant Cell Physiol.*, **42**: 900-905.
- Garretton, V., Carpinelli, J., Jordana, X., and Holuigue, L., 2002. The *as-1* promoter element is an oxidative stress-responsive element and salicylic acid activates it *via* oxidative species. *Plant Physiol.*, **130**: 1516-1526.
- Gozzo, F., 2003. Systemic acquired resistance in crop protection: from nature to a chemical approach. *J. Agric. Food Chem.*, **51**: 4487-4503.
- Grootveld, M., and Halliwell, B., 1986. Aromatic hydroxylation as a potential measure of hydroxyl-radical formation *in vivo*. Identification of hydroxylated derivatives of salicylate in human body fluids. *Biochem. J.*, **273**: 499-504.
- Gupta, R., and Luan, S., 2003. Redox control of protein tyrosine phosphatases and mitogen-activated protein kinases in plants. *Plant Physiol.*, **132**: 1149-1152.
- Halliwell, B., Kaur, H., and Ingelman-Sundberg, M., 1991. Hydroxylation of salicylate as an assay for hydroxyl radicals: A cautionary note. *Free Radical Biol. Med.*, **10**: 439-441.
- Hashimoto, K., Saito, M., Matsuoka, H., Iida, K., and Iida, H., 2004. Functional analysis of a rice putative voltage-dependent Ca^{2+} channel, *OsTPC1*, expressed in yeast cells lacking its homologous gene *CCH1*. *Plant Cell Physiol.*, **45**: 496-500.
- Hedrich, R., Busch, H., and Raschke, K., 1990. Ca^{2+} and nucleotide dependent regulation of voltage dependent anion channels in the plasma membrane of guard cells. *EMBO J.*, **9**: 3889-3092.
- Hennig, J., Malamy, J., Gryniewicz, G., Indulski, J., and Klessig, D. F., 1993. Interconversion of the salicylic acid signal and its glucoside in plants. *Plant J.*, **4**: 593-600.
- Heo, W. D., Lee, S. H., Kim, M. C., Chung, W. S., Chun, H. J., Lee, K. J., Park, C. Y., Park, H. C., Choi, J. H., and Cho, M. J., 1999. Involvement of specific calmodulin isoforms in salicylic acid-independent activation of plant disease resistance responses. *Proc. Natl. Acad. Sci. USA.*, **96**: 766-771.
- Hetherington, A. M., and Brownlee, C., 2004. The generation of Ca^{2+} signaling in plants. *Annu. Rev. Plant Biol.*, **55**: 401-427.
- Hiraga, S., Sasaki, k., Ito, H., Ohashi, Y., and Matsui, H., 2001. A large family of class III plant peroxidases. *Plant Cell Physiol.*, **42**: 462-468.
- Howes, B.D., Feis, A., Raimondi, L., Indiani, C., and Smulevich, G., 2001. The critical role of the proximal calcium ion in the structural properties of horseradish peroxidase. *J. Biol. Chem.*, **276**: 40704-40711.

- Hunt, M. D., Neuenschwander, U. H., Delaney, T. P., Weymann, K. B., Friedrich, L. B., Lawton, K. A., Steiner, H. Y., and Ryals, J. A., 1996. Recent advances in systemic acquired resistance research - a review. *Gene*, **179**: 89-95.
- Ingelman-Sundberg, M., Kaur, H., Terelius, Y., Persson, J. O., and Halliwell, B., 1991. Hydroxylation of salicylate by microsomal fractions and cytochrome P-450. Lack of production of 2,3-dihydroxybenzoate unless hydroxyl radical formation is permitted. *Biochem. J.*, **276**: 753-757.
- Ishibashi, K., Suzuki, M., and Imai, M., 2000. Molecular cloning of a novel form (two-repeat) protein related to voltage-gated sodium and calcium channels. *Biochem. Biophys. Res. Commun.*, **270**: 370-376.
- Johnson, C., Boden, E., and Arias, J., 2003. Salicylic acid and NPR1 induce the recruitment of trans-activation TGA factors to a defense gene promoter in Arabidopsis. *Plant Cell*, **15**: 1846-1858.
- Kadota, Y., Furuichi, T., Ogasawara, Y., Goh, T., Higashi, K., Muto, S., and Kuchitsu, K., 2004. Identification of putative voltage-dependent Ca^{2+} -permeable channels involved in cryptogein-induced Ca^{2+} transients and defense responses in tobacco BY-2 cells. *Biochem. Biophys. Res. Commun.*, **317**: 823-830.
- Katou, S., Karita, E., Yamakawa, H., Seo, S., Mitsuhara, I., Kuchitsu, K., and Ohashi, Y., 2005. Catalytic activation of the plant MAPK phosphatase NtMKP1 by its physiological substrate salicylic acid-induced protein kinase but not by calmodulins. *J. Biol. Chem.*, **280**: 39569-39581.
- Katou, S., Yamamoto, H., Yoshioka, H., Kawakita, K., and Doke, N., 2003. Functional analysis of potato mitogen-activated protein kinase kinase, *StMEK1*. *J. Gen. Plant Pathol.*, **69**: 161-168.
- Kawano, T., 2003. Roles of the reactive oxygen species-generating peroxidase reactions in plant defense and growth induction. *Plant Cell Rep.*, **21**: 829-837.
- Kawano, T., Kawano, N., and Lapeyrie, F., 2002d. A fungal auxin antagonist, hypaphorine prevents the indole-3-acetic acid-dependent irreversible inactivation of horseradish peroxidase: inhibition of Compound III-mediated formation of P-670. *Biochem. Biophys. Res. Commun.*, **294**: 553-559.
- Kawano, T., Furuichi, T., and Muto, S., 2004b. Controlled free salicylic acid levels and corresponding signaling mechanisms in plants. *Plant Biotech.*, **21**: 319-335.
- Kawano, T., Kadono, T., Fumoto, K., Lapeyrie, F., Kuse, M., Isobe, M., Furuichi, T., and Muto, S., 2004c. Aluminum as a specific inhibitor of plant *TPCI* Ca^{2+} channels. *Biochem. Biophys. Res. Commun.*, **324**: 40-45.
- Kawano, T., Kadono, T., Furuichi, T., Muto, S., and Lapeyrie, F., 2003. Aluminum-induced distortion in calcium signaling involving oxidative bursts and channel regulations in tobacco BY-2 cells. *Biochem. Biophys. Res. Commun.*, **308**: 35-42.
- Kawano, T., Kawano, N., Hosoya, H., and Lapeyrie, F., 2001. Fungal auxin antagonist hypaphorine competitively inhibits indole-3-acetic acid-dependent superoxide generation by horseradish peroxidase. *Biochem. Biophys. Res. Commun.*, **288**: 546-551.
- Kawano, T., and Muto, S., 2000. Mechanism of peroxidase actions for salicylic acid-induced generation of active oxygen species and an increase in cytosolic calcium in tobacco suspension culture. *J. Exp. Bot.*, **51**: 685-693.
- Kawano, T., Muto, S., Adachi, M., Hosoya, H., and Lapeyrie, F., 2002a. Spectroscopic evidence that salicylic acid converts a temporal inactive form of horseradish peroxidase (Compound III) to the irreversibly inactivated verdohemoprotein (P-670). *Biosci. Biotech. Biochem.*, **66**: 646-650.

- Kawano, T., Muto, S., Adachi, M., Hosoya, H., and Lapeyrie, F., 2002b. Spectroscopic evidence in support of horseradish peroxidase Compound II-catalyzed oxidation of salicylic acid but not of phenylethylamine. *Biosci. Biotech. Biochem.*, **66**: 651-654.
- Kawano, T., Pinontoan, R., Hosoya, H., and Muto, S., 2002c. Monoamine-dependent production of reactive oxygen species catalyzed by pseudoperoxidase activity of human hemoglobin. *Biosci. Biotech. Biochem.*, **66**: 1224-1232.
- Kawano, T., Sahashi, N., Takahashi, K., Uozumi, N., and Muto, S., 1998. Salicylic acid induces extracellular generation of superoxide followed by an increase in cytosolic calcium ion in tobacco suspension culture: The earliest events in salicylic acid signal transduction. *Plant Cell Physiol.*, **39**: 721-730.
- Kawano, T., Tanaka, S., Kadono, T., and Muto, S., 2004a. Salicylic acid glucoside acts as a slow inducer of oxidative burst in tobacco suspension culture. *Z. Naturforsch.*, **59c**: 684-692.
- Keller, H., Hohlfeld, H., Wray, V., Hahlbrock, K., Scheel, D., and Strack, D., 1996. Changes in the accumulation of soluble and cell wall-bound phenolics in elicitor-treated cell suspension culture and fungus-infected leaves of *Solanum tuberosum*. *Phytochem.*, **42**: 389-396.
- Keller, T., Damude, H. G., Werner, D., Doerner, P., Dixon, R. A., and Lamb, C., 1998. A plant homolog of the neutrophil NADPH oxidase gp91^{phox} subunit gene encodes a plasma membrane protein with Ca²⁺ binding motifs. *Plant Cell*, **10**: 255-266.
- Kessmann, H., and Ryals, J., 1993. Requirement of salicylic acid for the induction of systemic acquired resistance. *Science*, **261**: 754-756.
- Klick, S., and Herrmann, K., 1988. Glucosides and glucose esters of hydroxybenzoic acids in plants. *Phytochem.*, **27**: 2127-2180.
- Knight, M. R., Campbell, A. K., Smith, S. M., and Trewavas, A. J., 1991. Transgenic plant aequorin reports the effects of touch and cold-shock and elicitors on cytosolic calcium. *Nature*, **352**: 524-526.
- Kumar, D., and Klessig, D. F., 2003. High-affinity salicylic acid-binding protein 2 is required for plant innate immunity and has salicylic acid-stimulated lipase activity. *Proc. Natl. Acad. Sci. USA.*, **100**: 16101-16106.
- Kunkel, B. N., and Brooks, D. M., 2002. Cross talk between signaling pathways in pathogen defense. *Curr. Opin. Plant Biol.*, **5**: 325-331.
- Kurusu, T., Sakurai, Y., Miyao, A., Hirochika, H., and Kuchitsu, K., 2004. Identification of a putative voltage-gated Ca²⁺-permeable channel (*OsTPCI*) involved in Ca²⁺ influx and regulation of growth and development in rice. *Plant Cell Physiol.*, **45**: 693-702.
- Kvaratskhelia, M., George, S. J., and Thorneley, R. N. F., 1997. Salicylic acid is a reducing substrate and not an effective inhibitor of ascorbate peroxidase. *J. Biol. Chem.*, **272**: 20998-21001.
- Laberge, M., Huang, Q., Schweitzer-Stenner, R., and Fidy, J., 2003. The endogenous calcium ions of horseradish peroxidase C are required to maintain the functional nonplanarity of the heme. *Biophys. J.*, **84**: 2542-2552.
- Lee, J.-S., 1998. The mechanism of stomatal closing by salicylic acid in *Commelina communis* L. *J. Plant Biol.*, **41**: 97-102.
- Léon, J., Yalpani, N., Raskin, I., and Lawton, M. A., 1993. Induction of benzoic acid 2-hydroxylase in virus-inoculated tobacco. *Plant Physiol.*, **103**: 323-328.
- Lieberherr, D., Wagner, U., Dubis, P.-H., Métraux, J.-P., and Mauch, F., 2003. The rapid induction of glutathione S-transferases *AtGSTF2* and *AtGSTF6* by Avirulent *Pseudomonas syringae* is the result of combined salicylic acid and ethylene signaling. *Plant Cell Physiol.*, **44**: 750-757.
- Lin, C., Yu, Y., Kadono, T., Iwata, M., Umemura, K., Furuichi, T., Kuse, M., Isobe, M., Yamamoto, Y., Mastumoto, H., Yoshizuka, K., and Kawano, T., 2005. Action of

- aluminum, novel TPC1-type channel inhibitor, against salicylate-induced and cold shock-induced calcium influx in tobacco BY-2 cells. *Biochem. Biophys. Res. Commun.*, **332**: 823-830.
- Longu, S., Medda, R., Padiglia, A., Pedersen, J. Z., and Floris, G., 2004. The reaction mechanism of plant peroxidases. *Ital. J. Biochem.*, **53**: 41-45.
- Malamy, J., Carr, J. P., Klessig, D.F., and Raskin, I., 1990. Salicylic acid: A likely endogenous signal in the resistance response of tobacco to viral infection. *Science*, **250**: 1002-1004.
- Malamy, J., Hennig, J., and Klessig, D. F., 1992. Temperature-dependent induction of salicylic acid and its conjugates during the resistance response to tobacco mosaic virus infection. *Plant Cell*, **4**: 359-366.
- Manthe, B., Schulz, M., and Schnable, H., 1992. Effects of salicylic acid on growth and stomatal movement on *Vicia faba* L.: evidence for salicylic acid metabolism. *J. Chem. Ecol.*, **18**: 1525-1539.
- Mauch, F., Mauch-Mani, B., Gaille, C., Kull, B., Haas, D., and Reimann, C., 2001. Manipulation of salicylic acid content in *Arabidopsis thaliana* by the expression of an engineered bacterial salicylate synthase. *Plant J.*, **25**: 67-77.
- Mauch-Mani, B., and Sulsarenko, A. J., 1996. Production of salicylic acid precursors is a major function of phenylalanine ammonia-lyase in the resistance of *Arabidopsis* to *Peronospora parasitica*. *Plant Cell*, **8**: 203-212.
- Medda, R., Padiglia, A., Longu, S., Bellelli, A., Arcovito, A., Cavallo, S., Pedersen, J. Z., and Floris, G., 2003. Critical role of Ca²⁺ ions in the reaction mechanism of *Euphorbia characias* peroxidase. *Biochem.*, **42**: 8909-8918.
- Mercado-Blanco, J., van der Drift, K. M. G. M., Olson, P. E., Thomas-Oates, J., van Loon, L. C., and Bakker, P. A. H. M., 2001. Analysis of the *pmsCEAB* gene cluster involved in biosynthesis of salicylic acid and the siderophore pseudomonine in the biocontrol strain *Pseudomonas fluorescens* WCS374. *J. Bacteriol.*, **183**: 1909-1920.
- Messner, B., and Schroder, P., 1999. Burst amplifying system in cell suspension cultures of spruce (*Picea abies*). Modulation of elicitor-induced release of hydrogen peroxidase (oxidative burst) by ionophores and salicylic acid. *J. Appl. Bot.*, **73**: 6-10.
- Métraux, J.-P., 2002. Recent breakthrough in the study of salicylic acid biosynthesis. *Tren. Plant Sci.*, **7**: 332-334.
- Métraux, J.-P., Signer, H., Ryals, J., Ward, E., Wyss-Benz, M., Gaudin, J., Raschdorf, K., Schmid, E., Blum, W., and Inverardi, B., 1990. Increase in salicylic acid at the onset of systemic acquired resistance in cucumber. *Science*, **250**: 1004-1006.
- Midoh, N., and Iwata, M., 1996. Cloning and characterization of a probenazole-inducible gene for an intracellular pathogenesis-related protein in rice. *Plant Cell Physiol.*, **37**: 9-18.
- Miyake, C., Sano, S., and Asada, K., 1996. A new assay of ascorbate peroxidase using the coupled system with monodehydroascorbate radical reductase. in: *Plant Peroxidases: Biochemistry and Physiology*, Obinger, C., Burner, U., Ebermann, R., Penel, C., Greppin., eds, Univ. Geneva, Vienna. pp. 386-389.
- Mori, I. C., Pinontoan, R., Kawano, T., and Muto, S., 2001. Involvement of superoxide generation in salicylic acid-induced stomatal closure in *Vicia faba*. *Plant Cell Physiol.*, **42**: 1383-1388.
- Mori, I. C., and Schroeder, J. I., 2004. Reactive oxygen species activation of plant Ca²⁺ channels. A signaling mechanism in polar growth, hormone transduction, stress signaling, and hypothetically mechanotransduction. *Plant Physiol.*, **135**: 702-708.
- Mou, Z., Fan, W. H., and Dong, X., 2003. Inducers of plant systemic acquired resistance regulate NPR1 function through redox changes. *Cell*, **113**: 935-944.

- Mura, A., Medda, R., Longu, S., Floris, G., Rinaldi, A. C., and Padiglia, A., 2005. A Ca^{2+} /calmodulin-binding peroxidase from *Euphorbia latex*: Nobel aspects of calcium-hydrogen peroxidase cross-talk in the regulation of plant defenses. *Biochem.*, **44**: 14120-14130.
- Murata, Y., Pei, Z. M., Mori, I. C., and Schroeder, J., 2001. Abscisic acid activation of plasma membrane Ca^{2+} channels in guard cells requires cytosolic NAD(P)H and is differentially disrupted upstream and downstream of reactive oxygen species production in *abi-1* and *abi-2* protein phosphatase 2C mutants. *Plant Cell*, **13**: 2513-2523.
- Muto, S., and Miyachi, S., 1977. Properties of a protein activator of NAD kinase from plants. *Plant Physiol.*, **59**: 55-60.
- Mölders, W., Buchala, A., and Métraux, J.-P., 1996. Transport of salicylic acid in tobacco necrosis virus-infected cucumber plants. *Plant Physiol.*, **112**: 787-792.
- Niederl, S., Kirsch, T., Riederer, M., and Schreiber, L., 1998. Co-permeability of ^3H -labeled water and ^{14}C -labeled organic acids across isolated plant cuticles. *Plant Physiol.*, **116**: 117-123.
- Niki, T., Mitsuhara, I., Seo, S., Ohtsubo, N., and Ohashi, Y., 1998. Antagonistic effect of salicylic acid and jasmonic acid on the expression of pathogenesis-related (PR) protein genes in wounded mature tobacco leaves. *Plant Cell Physiol.*, **39**: 500-507.
- Ohashi, Y., Murakami, T., Mitsuhara, I., and Seo, S., 2004. Rapid down and upward translocation of salicylic acid in tobacco plants. *Plant Biotech.*, **21**: 95-101.
- Passardi, F., Cosio, C., Penel, C., and Dunand, C., 2005. Peroxidases have more functions than a Swiss army knife. *Plant Cell Rep.*, **24**: 255-265.
- Pei, Z. M., Murata, Y., Benning, G., Thomine, S., Klusener, B., Allen, G. J., Grill, E., and Schroeder, J. I., 2000. Calcium channels activated by hydrogen peroxide mediate abscisic acid signaling in guard cells. *Nature*, **406**: 731-734.
- Peiter, E., Maathuis, F., Mills, L., Knight, H., Pelloux, J., Hetherington, A., and Sanders, D., 2005. The vacuolar Ca^{2+} -activated channel TPC1 regulates germination and stomatal movement. *Nature*, **434**: 404-408.
- Penel, C., 2000. The peroxidase system in higher plants, in: *Integrated Plant Systems*, Greppin, H., Penel, C., Broughton, W. J. and Strasser, R., eds, Univ. Geneva, Geneva, pp. 359-367.
- Penel, C., Gasper, T., and Greppin, H., 1992. *Plant peroxidases 1980-1990*, Univ. Geneva, Geneva.
- Pfeiffer, W., and Hoftberger, M., 2001. Oxidative burst in *Chenopodium rubrum* suspension cells: Induction by auxin and osmotic changes. *Physiol. Plant.*, **111**:144-150.
- Pieterse, C. M. J., and van Loon, L. C., 2004. NPR1: the spider in the web of induced resistance signaling pathways. *Cur. Opin. Plant Biol.*, **7**:456-464.
- Pott, M. B., Effmert, U., and Piechulla, B., 2003. Transcriptional and post-translational regulation of S-adenosyl-L-methionine: salicylic acid carboxyl methyltransferase (SAMT) during *Stephanotis floribunda* flower development. *J. Plant Physiol.*, **160**: 635-643.
- Pott, M. B., Hippauf, F., Saschenbrecker, S., Chen, F., Ross, J., Kiefer, I., Slusarenko, A., Noel, J. P., Pichersky, E., Effmert, U., and Piechulla, B., 2004. Biochemical and structural characterization of benzenoid carboxyl methyltransferases involved in floral scent production in *Stephanotis floribunda* and *Nicotiana suaveolens*. *Plant Physiol.*, **135**: 1946-1955.
- Qin, X. F., Holuigue, L., Horvath, D. M., and Chua, N. H., 1994. Immediate early transcription activation by salicylic acid via the cauliflower mosaic virus as-1 element. *Plant Cell*, **6**: 863-874.
- Rainsford, D. K., 1984. Aspirin and Salicylates. Butterworth, London.

- Ramakrishna, W., Emberton, J., SanMiguel, P., Ogden, M., Llaca, V., Messing, J., and Bennetzen, J. L., 2002. Comparative sequence analysis of the sorghum *Rph* region and the maize *Rp1* resistance gene complex. *Plant Physiol.*, **130**: 1728-1738.
- Raskin I., 1995. Salicylic acid. In: *Plant Hormone*, 2nd Ed., Davies, P. J. (Ed.), Kluwer Academic Press, Dordrecht. pp. 188-205.
- Rasmussen, J. B., Hammerschmidt, R., and Zook, M. N., 1991. Systemic induction of salicylic acid accumulation in cucumber after inoculation with *Pseudomonas syringae* pv. *Syringae*. *Plant Physiol.*, **97**:1342-1347.
- Raz, V., and Fluhr, R., 1992. Calcium requirement for ethylene-dependent responses. *Plant Cell*, **4**: 1123-1130.
- Ren, D., Yang, H., and Zhang, S., 2002. Cell death mediated by MAPK is associated with hydrogen peroxide production in Arabidopsis. *J. Biol. Chem.*, **277**: 559-565.
- Rhoads, D. M., and McIntosh, L., 1992. Salicylic acid regulation of respiration in higher plants: alternative oxidase expression. *Plant Cell*, **4**: 1131-1139.
- Sagi, M., and Fluhr, R., 2001. Superoxide production by plant homologues of the gp91^{phox} NADPH oxidase. Modulation of activity by calcium and by tobacco mosaic virus infection. *Plant Physiol.*, **126**: 1281-1290.
- Sagone, A. L., and Husney, R. M., 1987. Oxidation of salicylates by stimulated granulocytes: evidence that these drugs act as free radical scavengers in biological systems. *J. Immunol.*, **138**: 2127-2183.
- Samuel, M. A., Hall, H., Krzymowska, M., Drzewiecka, K., Hennig, J., and Ellis, B.E., 2005b. SIPK signaling controls multiple components of harpin-induced cell death in tobacco. *Plant J.*, **42**: 406-416.
- Samuel, M. A., Walia, A., and Mansfield, S. D., 2005a. Overexpression of SIPK in tobacco enhances ozone-induced ethylene formation and blocks ozone-induced SA accumulation. *J. Exper. Bot.*, **56**: 2195-2201.
- Sanders, D., Brownlee, C., and Harper, J. F., 1999. Communicating with calcium. *Plant Cell*, **11**: 691-706.
- Sanders, D., Pelloux, J., Brownlee, C., and Harper, J. F., 2002. Calcium at the crossroads of signaling. *Plant Cell*, **14**: S401-417.
- Schneider-Müller, S., Kurosaki, F., and Nishi, A., 1994. Role of salicylic acid and intracellular Ca²⁺ in the induction of chitinase activity in carrot suspension culture. *Physiol. Mol. Plant Pathol.*, **45**: 101-109.
- Seo, S., Ichizawa, K., and Ohashi, Y., 1995. Induction of salicylic acid-β-glucosidase in tobacco leaves by exogenous salicylic acid. *Plant Cell Physiol.*, **36**: 447-453.
- Serino, L., Reimann, C., Baur, H., Beyeler, M., Visca, P., and Haas, D., 1995. Structural genes for salicylate biosynthesis from chorismate in *Pseudomonas aeruginosa*. *Mol. Gen. Genet.*, **249**: 217-228.
- Shah, J., 2003. The salicylic acid loop in plant defense. *Curr. Opin. Plant Biol.*, **6**: 365-371.
- Shah, J., Kachroo, P., and Klessig, D. F., 1999. The *Arabidopsis* *ssi1* mutation restores pathogenesis-related gene expression in *npr1* plants and renders *Defensin* gene expression SA dependent. *Plant Cell*, **11**: 191-206.
- Shah, J., Tsui, F., and Klessig, D. F., 1997. Characterization of a salicylic acid-insensitive mutant (*sai1*) of *Arabidopsis thaliana*, identified in a selective screen utilizing the SA-inducible expression of the *tms2* gene. *Mol. Plant Microbe Interact.*, **10**: 69-78.
- Shah, K., Penel, C., Gagnon, J., and Dunand, C., 2004. Purification and identification of a Ca²⁺-pectate binding peroxidase from *Arabidopsis* leaves. *Phytochem.*, **65**: 307-312.
- Shirano, Y., Kachroo, P., Shah, J., and Klessig, D. F., 2002. A gain-of-function mutation in an Arabidopsis toll interleukin 1 receptor-nucleotide binding site-leucine-rich repeat type R

- gene triggers defense responses and results in enhanced disease resistance. *Plant Cell*, **14**: 3149-3162.
- Shulaev, V., Leon, J., and Raskin, I., 1995. Is salicylic acid a translocated signal of systemic acquired resistance in tobacco? *Plant Cell*, **7**: 1691-1701.
- Shulaev, V., Silverman, P., and Raskin, I., 1997. Airborne signalling by methyl salicylate in plant pathogen resistance. *Nature*, **385**: 718-721.
- Singh, D. P., Moore, C. A., Gilliland, A., and Carr, J. P., 2004. Activation of multiple antiviral defense mechanisms by salicylic acid. *Mol. Plant Pathol.*, **5**: 57-63.
- Slaymaker, D. H., Navarre, D. A., Clark, D., Del Pozo, O., Martin, G. B., and Klessig, D. F., 2002. The tobacco salicylic acid-binding protein 3 (SABP3) is the chloroplast carbonic anhydrase, which exhibits antioxidant activity and plays a role in the hypersensitive defense response. *Proc. Natl. Acad. Sci. USA.*, **99**: 11640-11645.
- Song, F., and Goodman, R.M., 2002. OsBIMK1, a rice MAP kinase gene involved in disease resistance responses. *Planta*, **215**: 997-1005.
- Spael, S. H., Koornneef, A., Claessens, S. M., Korzelius, J. P., Van Pelt, J.A., Mueller, M. J., Buchala, A. J., Metraux, J. P., Brown, R., Kazan, K., Van Loon, L. C., Dong, X., and Pieterse, C. M., 2003. NPR1 modulates cross-talk between salicylate- and jasmonate-dependent defense pathways through a novel function in the cytosol. *Plant Cell*, **15**: 760-770.
- Sticher, L., Mauch-Mani, B., and Metraux, J. P., 1997. Systemic acquired resistance. *Annu. Rev. Phytopath.*, **35**: 235-270.
- Sticher, L., Penel, C., and Greppin, H., 1981. Calcium requirement for the secretion of peroxidases by plant cell suspensions. *J. Cell Sci.*, **48**: 345-353.
- Tenhaken, R., and Rübel, C., 1997. Salicylic acid is needed in hypersensitive cell death in soybean but does not act as a catalase inhibitor. *Plant Physiol.*, **115**: 291-298.
- Torres, M. A., Onouchi, H., Hamada, S., Machida, C., Hammond-Kosack, K. E., and Jones, J. D., 1998. Six *Arabidopsis thaliana* homologues of the human respiratory burst oxidase (gp91^{phox}). *Plant J.*, **14**: 365-370.
- Turner, J.G., Ellis, C., and Devoto, A., 2002. The jasmonate signal pathway. *Plant Cell*, **14**: S153-S164.
- Ulm, R., Ichimura, K., Mizoguchi, T., Peck, S.C., Zhu, T., Wang, X., Shinozaki, K., and Paszkowski, J., 2002. Distinct regulation of salinity and genotoxic stress responses by Arabidopsis MAP kinase phosphatase 1. *EMBO J.*, **21**: 6483-6493.
- Uquillas, C., Letelier, I., Blanco, F., Jordana, X., and Holoigue, L., 2004. NPR1-independent activation of immediate early salicylic acid-responsive genes in *Arabidopsis*. *Mol. Plant-Microbe Interact.*, **17**: 34-42.
- Utoguchi, N., Watanabe, Y., Takase, Y., Suzuki, T., and Matsumoto, M., 1999. Carrier-mediated absorption of salicylic acid from hamster cheek pouch mucosa. *J. Pharmacol. Sci.*, **88**: 142-146.
- Van Dongen, J. T., Schurr, U., Pfister, M., and Geigenberger, P., 2003. Phloem metabolism and function have to cope with low internal oxygen. *Plant Physiol.*, **131**: 1529-1543.
- Van Tegelen, L. J., Moreno, P. R., Croes, A. F., Verpoorte, R., and Wullems, G. J., 1999. Purification and cDNA cloning of isochorismate synthase from elicited cell cultures of *Catharanthus roseus*. *Plant Physiol.*, **119**: 705-712.
- Van Wees, S. C. M., and Glazebrook, J., 2003. Loss of non-host resistance of *Arabidopsis NahG* to *Pseudomonas syringae* pv. phaseolicola is due to degradation products of salicylic acid. *Plant J.*, **33**: 733-742.
- Vane, J. R., and Botting, R. M., 2003. The mechanism of action of aspirin. *Thromb. Res.*, **110**: 255-258.

- Verberne, M. C., Verpoorte, R., Bol, J. F., Mercado-Blanco, J., and Linthorst, H. J., 2000. Overproduction of salicylic acid in plants by bacterial transgenes enhances pathogen resistance. *Nature Biotech.*, **18**: 779-783.
- Vernooij, B., Friedrich, L., Morse, A., Reist, R., Kolditz-Jawhar, R., Ward, E., Uknes, S., Kessmann, H., and Ryals, J., 1994. Salicylic acid is not the translocated signal responsible for inducing systemic acquired resistance but is required in signal transduction. *Plant Cell*, **6**: 959-965.
- Ward, E. R., Uknes, S. J., Williams, S. C., Dincher, S. S., Wielderhol, D. L., Alexander, D. C., Ahl-Goy, P., Métraux, J. P., and Ryals, J., 1991. Coordinate gene activity in response to agents that induce systemic acquired resistance. *Plant Cell*, **3**: 1085-1094.
- Weissman, G., 1991. Aspirin. *Sci. Amer.*, **264**: 84-90.
- White, P. J., Bowen, H. C., Demidchik, V., Nichols, C., and Davies, J. M., 2002. Genes for calcium-permeable channels in the plasma membrane of plant root cells. *Biochem. Biophys. Acta*, **1564**: 299-309.
- White, R. F., 1979. Acetylsalicylic acid induces resistance to tobacco mosaic virus in tobacco. *Virology*, **99**: 410-412.
- White-Stevens, R. H., and Kamin, H., 1972. Studies of a flavoprotein, salicylate hydroxylase. *J. Biol. Chem.*, **247**: 2358-2370.
- Wildermuth, M. C., Dewdney, J., Wu, G., and Ausubel, F. M., 2001. Isochorismate synthase is required to synthesize salicylic acid for plant defense. *Nature*, **414**: 562-565.
- Xiao, S. Y., Ellwood, S., Calis, O., Patrick, E., Li, T. X., Coleman, M., and Turner, J. G., 2001. Broad-spectrum mildew resistance in *Arabidopsis thaliana* mediated by *RPW8*. *Science*, **291**: 118-120.
- Xiao, S., Brown, S., Patrick, E., Brearley, C., and Turner, J. G., 2003. Enhanced transcription of the *Arabidopsis* disease resistance genes *RPW8.1* and *RPW8.2* via a salicylic acid-dependent amplification circuit is required for hypersensitive cell death. *Plant Cell*, **15**: 33-45.
- Xu, L., Liu, F., Lechner, E., Genschik, P., Crosby, W. L., Ma, H., Peng, W., Huang, D., and Xie, D., 2002. The SCF^{COI1} ubiquitin-ligase complexes are required for jasmonate response in *Arabidopsis*. *Plant Cell*, **14**: 1919-1935.
- Yalpani, N., Siverman, P., Wilson, T. M. A., Kleier, D. A., and Raskin, I., 1991. Salicylic acid is a systemic signal and an inducer of pathogenesis-related proteins in virus-infected tobacco. *Plant Cell*, **3**: 809-818.
- Yamakawa, H., Katou, S., Seo, S., Mitsuhara, I., Kamada, H., and Ohashi, Y., 2004. Plant MAPK phosphatase interacts with calmodulins. *J. Biol. Chem.*, **279**: 928-936.
- Yamakawa, H., Mitsuhara, I., Ito, N., Seo, S., Kamada, H., and Ohashi, Y., 2001. Transcriptionally and post-transcriptionally regulated response of 13 calmodulin genes to tobacco mosaic virus-induced cell death and wounding in tobacco plant. *Eur. J. Biochem.*, **268**: 3916-3929.
- Yang, K. Y., Liu, Y., and Zhang, S., 2001. Activation of a mitogen-activated protein kinase pathway is involved in disease resistance in tobacco. *Proc. Natl. Acad. Sci. USA.*, **98**: 741-746.
- Yokawa, K., 2005. A computational model of plant signaling mechanism involved in environmental responses: Construction of an artificial plant cell with calcium homeostasis. *Abstract book, Xiamen 2005, 2nd International Workshop on Environmental and Metabolic Biochemistry of Plants and Microorganisms*, Xiamen Univ., China. pp.24-25.
- Yoshioka, H., Numata, N., Nakajima, K., Katou, S., Kawakita, K., Rowland, O., Jones, J. D., and Doke, N., 2003. *Nicotiana benthamiana* gp91^{phox} homologs *NbrbohA* and *NbrbohB* participate in H₂O₂ accumulation and resistance to *Phytophthora infestans*. *Plant Cell*, **15**: 706-718.

- Yoshioka, H., Sugie, K., Park, H. J., Maeda, H., Tsuda, N., Kawakita, K., and Doke, N., 2001b. Induction of plant gp91^{phox} homolog by fungal cell wall, arachidonic acid, and salicylic acid in potato. *Mol. Plant Microbe Interact.*, **14**: 725-736.
- Yoshioka, K., Nakashita, H., Klessig, D.F., and Yamaguchi, I., 2001a. Probenazole induces systemic acquired resistance in Arabidopsis with a novel type of action. *Plant J.*, **25**: 149-57.
- Yuasa, T., Ichimura, K., Mizoguchi, T., and Shinozaki, K., 2001. Oxidative stress activates *ATMPK6*, an Arabidopsis homologue of MAP kinase. *Plant Cell Physiol.*, **42**: 1012-1016.
- Zhang, S., and Liu, Y., 2001. Activation of salicylic acid-induced protein kinase, a mitogen-activated protein kinase, induces multiple defense responses in tobacco. *Plant Cell*, **13**: 1877-1889.
- Zhang, S., and Klessig, D. F., 1997. Salicylic acid activates a 48-kD MAP kinase in tobacco. *Plant Cell*, **9**: 809-824.
- Zhang, Y., Fan, W., Kinkema, M., Li, X., and Dong, X., 1999. Interaction of NPR1 with basic leucine zipper protein transcription factors that bind sequences required for salicylic acid induction of the PR-1 gene. *Proc. Natl. Acad. Sci. USA.*, **96**: 6523-6528.

Chapter 11

SALICYLIC ACID AND LOCAL RESISTANCE TO PATHOGENS

IGOR V. MAKSIMOV AND LUBOV G. YARULLINA

Institute of Biochemistry and Genetics, Ufa Research Centre, Russian Academy of Science, 450054, Ufa, pr. Oktyabrya, 69, RUSSIA

Abstract: Salicylic acid triggers is the system for acquired resistance to phytopathogens and hypersensitive cell death of infected cells. It was shown that in "sick" plants salicylic acid induced protective response, caused by increasing the level of multiple local reactive oxygen species with the participation of oxalate oxidase and also lignification of pathogen penetration zone by involving peroxidase. The localization of oxidative burst leads to the death of pathogen and isolation of host infected tissues that were provided with "chitin-specificity" of these enzymes. Induction of activity of wheat "chitin-specific" oxalateoxidase and anionic peroxidase, intensification of their secretion into intercellular space under salicylic acid influence, that provides successful defense reactions, close to pathogen infection structures have been revealed.

Key words: *Triticum aestivum* - *Tilletia caries* - calli – co-culturing - salicylic acid - peroxidase - oxalateoxidase – diaminobenzidine colored (DAB-colored) - lignification - systemic and local resistance

1. INTRODUCTION

Plants defend themselves, against pathogens, through constitutive and inducible barriers. Induced resistance can be expressed locally at the site of infection, as well as systemically. It is communicated by the production of signals, released from the infected leaf and translocated to other parts of the plants where it induces defence reactions. This form of induced resistance is called systemic acquired resistance (SAR). It emphasizes the power of plants to acquire a state of general resistance, after an initial infection.

Incompatible plant-pathogen- interactions lead to the phenomenon known as programmed cell death (Mittler, 2002). Activation of programmed cell death during hypersensitive response results in the formation of a zone of dead cells around the infected site. Hydrogen peroxide (H_2O_2) is produced around the developing papillae of barley leaves, infected with agent of powdery mildew, (Thordal-Christensen *et al.*, 1997) or *Bipolaris sorokiniana* (Schafer *et al.*, 2004).

Salicylic acid (SA) is known to induce SAR with reactive oxygen species as an important component (Alvarez, 2000; Kawano and Muto, 2000). In addition, SA can change, depending on H_2O_2 concentration (Shakirova, 2001) the activities of catalase and peroxidase (Durner and Klessig, 1995; Guan and Scandalios, 1995). It is supposed that SA modulates these activities by having a direct interaction with these enzymes (Chen *et al.*, 1997) or by controlling their *de novo* synthesis (Agrawal *et al.*, 2002).

The increase in the production of reactive oxygen intermediates (ROI) and that of H_2O_2 may be referred as universal protective reactions operative in plants, against different stresses. The basic enzyme that participates in the formation of ROI is NADP-oxidase (Hippeli *et al.*, 1999). However, H_2O_2 accumulation in plant tissues may as a result of the activation of different carbohydrate oxidases (Custers *et al.*, 2004), for example, the oxidation of oxalic acid by oxalateoxidase (OxO). It is known that under SA treatment or pathogen infection certain genes undergo derepression and the activity of resulting enzymes increases (Dumas *et al.*, 1995; Custers *et al.*, 2004).

Plants increase the level of lignin which is the most effective barrier against phytopathogen invasion, during pathogenesis (Ride, 1980; Yarullina *et al.*, 1997). It is fact because reactive oxygen species and lignin-like materials accumulate at the site through which the pathogenic fungus penetrates into plant cell (Hukelhoven *et al.*, 2000). The exact mechanism for this phenomenon is unclear, but may be supposed that pathogens carry some unknown substances on their cell surface that attract plant enzymes, involved in H_2O_2 generation and lignin biosynthesis.

Peroxidase (PO) is an enzyme that quickly responds to various stress agents and is actively involved in lignification process. Its activity increases in plant tissues, infected by pathogens (Caruso *et al.*, 1999) and is associated with cell wall (Yarullina *et al.*, 1997). Data is available on the ability of PO to get effectively involved in intermolecular linked processes, encompassing various plant cell wall components, such as cellulose, callose, xylans and pectins (Carpin *et al.*, 2001; Brownleader *et al.*, 2002). However, the broad substrate specificity and multiplicity of PO isoforms obscure the role of this enzyme in plant development and adaptation to a hostile environment.

We have found that PO activity increased in the presence of chitin, in comparison with its activity in crude extracts in all tested plants. This

activation can occur both in chitin-sorbed fraction, and also in the fraction not sorbed on chitin (Maksimov *et al.*, 2003). These data confirm the possibility of PO activation in the presence of polysaccharides (Siegel, 1958).

2. ROLE OF SALICYLIC ACID IN POTENTIATION OF CELL DEATH

Combined callus cultures with fungous disease agents are the convenient models for studying local resistance (Ingram and MacDonald, 1986; Kearney *et al.*, 1991). Earlier we have demonstrated that the infection of wheat calli with the fungus *T. caries* promoted callus fresh mass because of changes in the hormonal status of plant cells (Maksimov *et al.*, 2002). When the infected calli were cultured on the medium containing SA, they did not grow actively and did not differ substantially from the control calli (Maksimov *et al.*, 2004). On the 6th day after infection, we observed dark necrotic lesions near the sites of fungal teliospore inoculation (Figure 1).

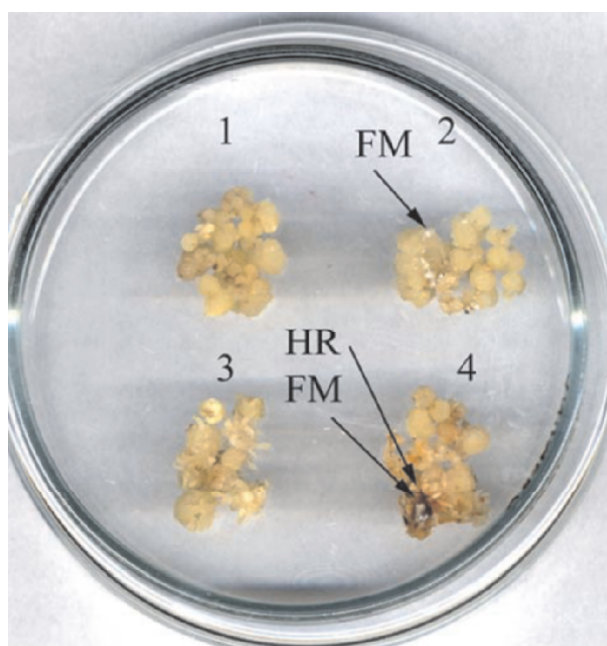

Figure 1. Salicylic acid influence on the co-culture of wheat callus and *T. caries* (fungal mycelium (FM)). The formation of necrotic zones (HR) in mycelium growth sites (follow the arrows). 1- control (MS), 2- *T. caries* (MS), 3- MS + 0,05 mM salicylic acid, 4 - *T. caries* (MS + 0,05 mM salicylic acid) (Maksimov *et al.*, 2004).

Such a phenomenon was observed in the calli co-cultured with the fungus *T. caries* for the first time. It possibly characterizes the induction of callus defense response comparable with hypersensitive response of resistant plants, infected with incompatible phytopathogen forms (Alvarez, 2000). This effect, may probably be the reason for some retardation of the fungal growth, during further co-culturing on the nutrient medium containing SA. Thus, the retardation of biotrophic fungus *T. caries* growth on the callus surface is related to the development of necrotic lesions in the penetration zone of plant cells. This is the response of the plant to infection.

3. SALICYLIC ACID AND GENERATION OF HYDROGEN PEROXIDE

Physiologically active substances, SA in particular, are known to change metabolic processes in plant cells; for example, they reduce the activity of antioxidant enzymes utilizing reactive oxygen species (Durner and Klessig, 1995; Chen *et al.*, 1997; Mittler, 2002). This, in turn, leads to abrupt predominance of ROI generation, in comparison with its degradation. This has a negative impact on the pro/antioxidant status in plant cell, leading to oxidative burst. It may be proposed that for effective plant cell defence, against phytopathogens oxidative burst must be local and should concern only with infestation zone and normal healthy cells must be fenced from this zone by special screen.

Irreversible changes occur in cells with on going fast accumulation of these oxygen species which result in the development of the hypersensitive plant response, preventing pathogen penetration in its tissues. Indeed, we detected the development of necrotic zones and reduced PO activity during the initial period (3 h) after infection in wheat calli, infected with *T. caries* grown in the presence of SA.

Diaminobenzidine coloring (DAB-coloring) was typical only for rhizoid cells. In uninfected calluses and in calluses growing on the medium containing SA, during infection, parenchyma-like cells (about 20%) with DAB –colored material were noticed in the fungus penetration zone. There were fungus hyphas which were also DAB-colored (Figure 2).

During the cultivation of infected wheat calluses on the MS medium, containing SA, the quantity of DAB-colored cells increased up to 30%, in fungus grown area which probably together with the violation of the pathogen morphology caused deceleration of fungus growth.

Thus, both the presence of DAB-material in the infected cells and the effect of SA shows that their protective effect is connected with intensification of H₂O₂ production (Troshina *et al.*, 2004). A lot of data

exists about OxO participation in protective reactions in plants, during phytopathogen infection (Dumas *et al.*, 1995). An increase in the activity of this protein (OxO) has been discovered in plants under the influence of phytopathogens and their elicitors (Wei *et al.*, 1998). The data obtained on OxO activity in wheat calluses, both under the influence of *T. caires* infection and treatment with SA, might assume the likeness of defense reactions of plant cell both *in vivo* and *in vitro*. These data also disclose one of the protective mechanisms of a well-known plant resistance inductor – SA.

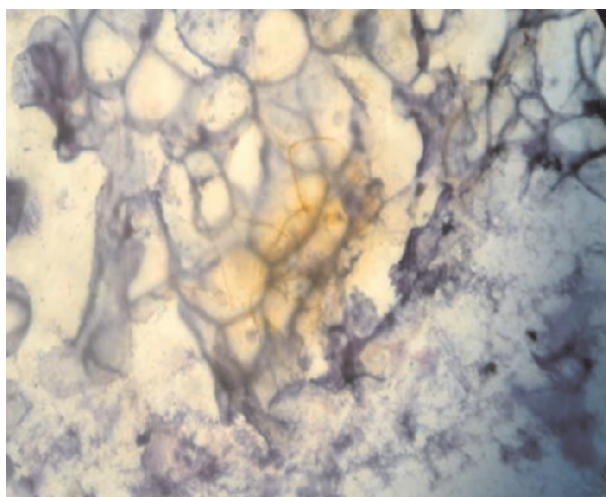

Figure 2. Detection of H₂O₂ in wheat calluses with 3,3-diaminobenzidine in *T. caires* invasion zone. The microscopic sections were stained with DAB and methylene blue. 500x. (Maksimov *et al.*, 2004)

4. INFLUENCE OF SALICYLIC ACID ON THE ACTIVITY OF PLANT ISOPEROXIDASE

Development of a local resistance under SA influence, is connected with the strengthening of lignification processes in places of pathogen localization. It is interesting, that on a background of general inhibition of peroxidase activity, some isoforms participating in lignification (Figure 3) are activated under influence of SA (Maksimov *et al.*, 2004).

Thus, in wheat calli, the activity of anionic PO with pI ~ 3.5 increased. The activity of PO with pI ~ 5.1 was maintained. When the infected calli were treated with SA, a tendency for maximum PO suppression is sustained. However, the cytoplasmic anionic PO with pI ~ 3.5 (no. 1) was greatly

activated. In this treatment, the activities of PO with pI ~ 4.8 (no. 4), ~ 7.5 (no. 7), and ~ 9.8 (no. 14) increased as well. It is worth mentioning that all detected PO are involved in plant defense responses, against phytopathogenic fungi. For example, it was shown that, anionic PO were activated in the resistant wheat seedlings, infected with bunt or septoriosis infection agents (Khairullin *et al.*, 2000; 2001), as compared to the susceptible seedlings. Wheat PO with pI ~7.5 is known to exhibit antifungal activity (Caruso *et al.*, 2001).

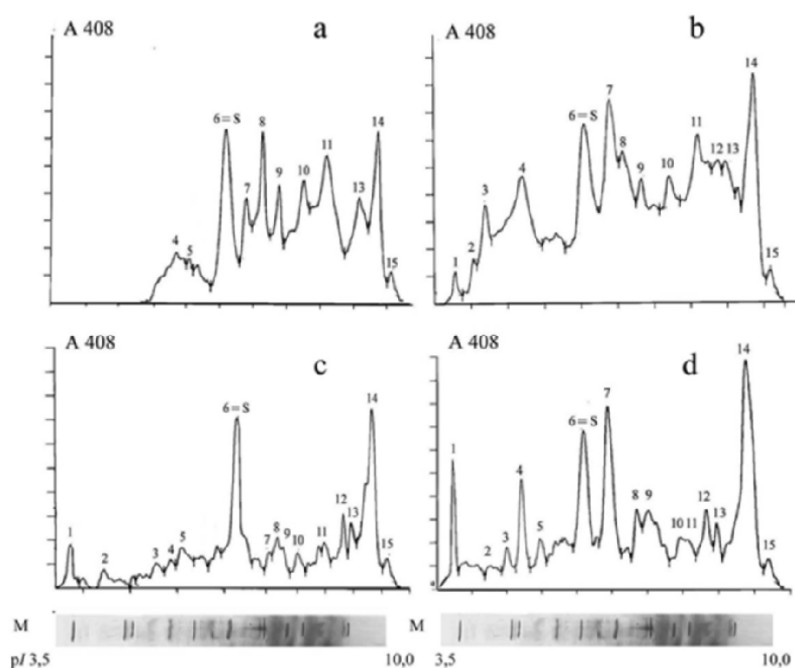

Figure 3. Densitograms of the gels after isoelectrofocusing of cytoplasmic isoperoxidases isolated from wheat calli 10 days after infection or 15 days after passage (Maksimov *et al.*, 2004): a - control calli, on the MS medium; b - calli, on the MS medium infected with *T. caries*; c - calli, on the MS medium supplemented with 0.05 mM salicylic acid; d - calli, infected with *T. caries* on the MS medium supplemented with 0.05 mM salicylic acid. S—the site of sample application; M—marker proteins with pI from ~3.5 to ~9.3 (Sigma, US): amyloglucosidase from *Aspergillus niger* with pI ~3.5, trypsin inhibitor from soybean with pI ~4.6, lactoglobulin from milk with pI ~5.1, acid myoglobin with pI ~6.85, basic myoglobin with pI ~7.35, lactic dehydrogenase with pI ~8.3–8.6 and trypsinogen with pI ~9.3.

Wheat, peroxidase with pI from 4.8 to 5.2, was shown to be activated with ABA (Khairullin *et al.*, 2001). This isoform was particularly active in the infected calli, which probably was related to ABA accumulation in wheat calli, co-cultured with the fungus in our experiments (Maksimov *et al.*, 2004). It is important, that ionically-bound anionic PO is most activated in

wheat calli, co-cultured with *T. caries*. PO were not active in the infected calli, grown in the absence of SA.

The involvement of PO in plant defense responses, against pathogens (Rasmussen *et al.*, 1995; Liu and Kolattukudy, 1997) and insect injury (Van der Westhuizen *et al.*, 1998) was repeatedly reported. Phytopathogens, their elicitors, various abiotic stresses, and some phytohormones can induce their expression in plant tissues (Muthukrishnan *et al.*, 2001).

5. MECHANISMS OF LOCAL RESISTANCE WITH PARTICIPATION OF OXALATE OXIDASE AND PEROXIDASE

Cellular walls of many pathogenic fungi contain chitin (Peberdy, 1988). We have shown that wheat OxO and anionic PO, activated under SA influence, were capable to sorb on acetylated chitin without the loss of enzyme activity (Maksimov *et al.*, 2005). Moreover, it is revealed that activation of OxO, under SA influence, occurs strongly in the cellular wall zone of tissues subjected to infection leading to amplification of H₂O₂ generation in immediate proximity to infectious structures of pathogen. Besides, SA raises activity of anionic PO, participating in lignification. The characteristic of wheat PO and OxO to be activated by SA and chitin (Maksimov *et al.*, 2003; 2004) and to be sorbed on latter suggests their involvement in processes underlying two reaction types, providing the plant with protection against phytopathogens.

The first type includes, fast differential activation of the enzymes upon its contact with pathogen cell structures. PO activation by chitin is probably comparable with its activation in the hypersensitive reaction. The latter is known to be one of the most powerful defense features of plants by which the plant organism sacrifices a portion of infected cells thus ridding the plant from phytopathogen (Metraux, 2001). Such kind of reaction often develops when host plant cells are affected by avirulent populations of biotrophic pathogens (Wojtaszek, 1995).

The second reaction type, is comparable with a gradual accumulation of the enzyme molecules in the fungus located zone, associated with the appearance of a peculiar “attracting” center on the chitin-containing phytopathogen structures. Binding of PO and OxO with fungal chitin can result in the decrease of concentration of enzyme molecules, interacting with chitin at the penetration site of infected cell (Maksimov *et al.*, 2005). This probably, in turn, results in the influx of the new enzyme molecules which is activity amplified under SA. Thus a peculiar flux of isoenzymes is formed at the site of fungus localization, resulting in the saturation of the chitin

containing phytopathogen mycelium surface with specific PO and OxO. Hence, favorable conditions for lignification of the region of phytopathogen penetration and localization appear under conditions of an incompatible pathogenic system (Ride, 1980).

We can not rule out the coupling of these phenomena. In this case, a necrosis occurs in association with the generation of toxic free radicals in the tissues subjected to intensive colonization with fungus (Apostol *et al.*, 1989; Peng and Kuc, 1992) or development of hypersensitive reaction (Mittler, 2002). Lignification of single pathogen structures occurs with the involvement of PO, to be sorbed on phytopathogen cell wall, in cells close to necrosis.

Hence, the outcome of the pathological process probably depends on the rate of PO inactivation in infected cells and on the intensity of enzyme sorption on mycelium of chitin containing pathogen. For instance, we have demonstrated lignin synthesis with greater intensity and manifold elevation of anionic chitin-specific PO activities in wheat resistant to *Septoria nodorum* (Khairullin *et al.*, 2001) and *T. caries* (Maksimov *et al.*, 2004).

The role of some PO in plant resistance to phytopathogens has been discussed for many years, but the contribution of each PO in the formation of physiological processes that occur in plants during pathogenesis is not well defined. Anionic PO is known to be substantially activated when a plant is damaged by a phytopathogen or insect (Repka and Jung, 1995). They are thought to be responsible for lignification of impaired plant tissues (Dowd *et al.*, 1998). It is notable that zucchini anionic PO sorbed on chitin can interact with plant oligogalacturonides in the presence of Ca^{2+} as well (Carpin *et al.*, 2001).

We demonstrated earlier, PO and OxO activation on contact with chitin and a capability of chitin-specific PO to concentrate themselves on chitin (Maksimov *et al.*, 2003). As we assume from our data, the sorption of “chitin-specific” PO, activated by SA, to chitin may occur through a mechanism differing from typical ion-exchange in nature, because both anionic and cationic plant PO can bind to this biopolymer. PO, with similar isoelectric points, can display different affinity to chitin, that enabled us to compare the “chitin-specific” PO isoforms with monovalent plant lectins – extensions, that characterized with high affinity to hemicellulose (Brownleader *et al.*, 2002). They are functionally bound to plant cell wall and act as its modifiers. It is notable that proline-rich sites, similar to those in extensions, are found in some PO isoforms, isolated from *Scutellaria baicalensis* Georgi, family *Lamiaceae* Lindl (Morimoto *et al.*, 1999). Some tomato PO are able to form complexes with typical cell wall extensin (Brownleader *et al.*, 2002).

These data reveal peculiarities in plant PO with regard to their interaction with polysaccharides, as well as the role of this phenomenon in the regulation of plant defense mechanism, against the penetration of chitin containing phytopathogens. That, for wheat anionic PO has the ability to bind to chitin and germinating spores of the fungus *T. caries* (Khairullin *et al.*, 2000). Thus, anionic chitin-specific PO, which was greatly activated in our experiments with infected calli, can be assigned to the pathogen induced proteins.

The appearance of ionically-bound PO and ionically-bound OxO in the fraction of cell walls from calli co-cultured with the fungus or treated with SA implies their active accumulation in the zone of plant cell walls. It was assumed that PO secreted into the intercellular space and bound to the cell wall can produce lignin in the process by involving phenolic compounds and extensin-like proteins (Otte and Barz, 2000; Blee *et al.*, 2001).

It should be emphasized that the anionic PO and OxO appeared in the cell walls of wheat calli, infected by bunt agent *T. caries*. It demonstrates that this isoform is involved in the interaction between pathogen and plant cell, while in the control calli (healthy calli, untreated with SA) this isoform was absent. The high activity of PO in the culture medium indicates its active secretion from the cytoplasm into the intercellular space where the enzyme is involved in the reinforcement of the cell walls and thus can hinder active pathogen growth as it was demonstrated earlier (Otte and Barz, 2000; Sharma and Singh, 2002). On the basis of the obtained results we propose that the activation of the OxO and PO enzymes (under SA treatment), generation of ROI, synthesis of phenol polymers and the toxic metabolites against the pathogens in the wheat tissues might take place "in the necessary place" and "at the necessary time". These events together with the appearance of the chitin-containing microorganisms in plant tissue automatically create a target for the attack by the both chitin-specific PO and OxO.

6. ACKNOWLEDGEMENT

Authors is thankful to Russian Foundation for Basic Research for granting the research project (01-04-48495, 05-04-48310)

7. REFERENCES

- Agrawal, G.K., Rakwal, R., and Jwa, N.-S., 2002. Cloning and Characterization of a Jasmonate Inducible Rice (*Oriza sativa* L.) Peroxidase Gene OsPOX against Global Signaling Molecules and Certain Inhibitors of Kinase-Signaling Cascade(s). *Plant Sci.*, **162**:49–58.
- Alvarez, M.E. 2000. Salicylic acid in the machinery of hypersensitive cell death and disease resistance. *Plant Mol. Biol.*, **44**: 429-442.
- Apostol, I., Heinstejn, P.F., and Low, P.S. 1989. Rapid stimulation of an oxidative burst during elicitation of cultured plant cells. *Plant Physiol.*, **90**: 109-116.
- Blee, K.A., Wheathely, E.R., Bonham V.A., Mitchell, G.P., Robertson, D., Slabas, A.R., Burrell, M.M., Wojtaszek, P., and Bolwell, G.P. 2001. Proteomic analysis reveals a novel set of cell wall proteins in a transformed tobacco cell culture that synthesizes secondary walls as determined by biochemical and morphological parameters. *Planta*, **212**: 404-415.
- Brownleader, M.D., Hopkins, J., Mobasher, A., Dey, P.M., Jackson, P., and Trevan, M. 2002. Role of extension peroxidase in tomato (*Lycopersicon esculentum* Mill.) seedling growth. *Planta*, **210**: 668-676.
- Carpin, S., Crevecoeur, M., de Meyer, M., Simon, P., Greppin, H., and Pennel, C., 2001. Identification of Ca²⁺-pectate binding peroxidase on an apoplastic peroxidase. *Plant Cell*, **13**: 511-520.
- Caruso, C., Chilosi, G., Leonardi, L., Bertini, L., Margo, P., Buonocore, V., and Capolare, C., 2001. A Basic Peroxidase from wheat kernel with antifungal activity. *Phytochem.*, **58**: 743–750.
- Chen, Z., Iyer, S., Caplan, A., Klessing, D.F., and Fan, B., 1997. Differential accumulation of salicylic acid-sensitive catalase in different rice tissues. *Plant Physiol.*, **114**: 193–201.
- Custers, J.H.H.V., Harrison, S.J., Sela-Buurlage, M.B., Van Deventer, E., Lageweg, W., Howe, P.W., Van der Meijis, P.J., Ponstein, A.S., Simons, B.H., Melchers, L.S., and Stuiver, M.H., 2004. Isolation and characterisation of a class of carbohydrate oxidases from higher plants, with a role in active defence. *Plant J.*, **39**: 147-160.
- Dowd, P.F., Lagrimini, L.M., and Herms, D.A., 1999. Tobacco anionic peroxidase often increases resistance to insects in different dicotyledonous species. *Pesticide Sci.*, **55**: 633-634.
- Dumas, B., Freyssinet, G., and Pallet, R.E., 1995. Tissue-specific expression of germin-like oxalate oxidase development and fungal infection of barley seedlings. *Plant Physiol.*, **107**: 1091-1096.
- Durner, J., and Klessig, D.F., 1995. Inhibition of ascorbate peroxidase by salicylic acid and 2,6-Dichloroisonicotinic acid, two inducers of plant defense. *Proc. Natl. Acad. Sci. USA.*, **92**: 11312–11316.
- Guan, L. and Scandalios, J.G. 1995. Developmentally related responses of maize catalase gene to salicylic acid. *Proc. Natl. Acad. Sci. USA.*, **92**: 5930–5954.
- Hippeli, S., Heiser, I., and Elstner, E. F., 1999. Activated oxygen and free oxygen radicals in pathology: New insights and analogies between animals and plants. *Plant Physiol. Biochem.*, **37**: 167-178.
- Hukelhoven, R., Fodor, J., Trujillo, M. and Kogel, K.-H. 2000. Barley Mla and Rar mutants compromised in the hypersensitive cell death response against *Blumeria graminis* f.sp. *hordei* are modified in their ability to accumulate reactive oxygen intermediates at sites of fungal invasion. *Planta*, **212**: 16-24.
- Ingram, D.S., and MacDonald, M.V. 1986. *In vitro* selection of mutants. In: Nuclear techniques and *in vitro* culture for plant improvement. Vienna: IAEA, 241-257
- Kawano, T., and Muto, S., 2000. Mechanism of peroxidase action for salicylic acid induced generation of active oxygen species and an increase in cytosolic calcium in tobacco cell

- suspension culture. *J. Exp. Bot.*, **51**: 685–693.
- Kearney, J.F., Parrott, W.A., and Hill, N.S. 1991. Infection of somatic embryos of tall fescue with *Acremonium coenophialum*. *Crop Sci.*, **31**: 979-984.
- Khairullin, R. M., Yusupova, Z. R., and Maksimov, I. V. 2000. Protective responses of wheat treated with fungal pathogens: 1. Interaction of wheat anionic peroxidases with chitin, chitosan, and teliospores of *Tilletia caries*. *Russian.J. Plant Physiol.*, **47**: 97–102.
- Khairullin, R.M., Maksimov, I.V., and Yusupova, Z.R., 2001. Activation of anionic peroxidase isoforms in septoria- infected wheat plants and possible involvement of IAA and ABA in this process, *Mikol. Fitopatol.*, **35**: 47–53.
- Liu, M.-X., and Kolattukudy, P.E., 1997. Expression of an anionic peroxidase and oxidative burst in tomato cells induced by the elicitor from *Verticillium albo-atrum* // *Acta Phytophysiol. Sin.*, **23**: 220-226
- Maksimov, I.V., Ganiev, R.M., and Khairullin, R.M., 2002. Changes in the Levels of IAA, ABA, and Cytokinins in Wheat Seedlings Infected with *Tilletia caries*. *Russian.J. Plant Physiol.*, **49**: 248–252.
- Maksimov, I.V., Cherepanova, E.A., and Khairullin, R.M., 2003. “Chitin-specific” peroxidases in plants. *Biochem. (Moscow)*, **68**: 111-115.
- Maksimov, I.V., Surina, O.B., Sakhabutdinova, A.R., Troshina, N.B., and Shakirova, F. M., 2004. Changes in the phytohormone levels in wheat calli as affected by salicylic acid and infection with *Tilletia caries*, a bunt pathogenic agent. *Russian J. Plant Physiol.*, **51**: 228–233
- Maksimov, I.V., Cherepanova, E.A., Surina, O.B., and Sakhabutdinova, A.R. 2004. The effect of salicylic acid on peroxidase activity in wheat calli cocultured with the bunt pathogen. *Russian J. Plant Physiol.*, **51**: 480–485.
- Mettraux, J.-P., 2001. Systemic acquired resistance and salicylic acid: current state of knowledge. *Eur. J. of Plant Pathol.*, **107**: 13–18.
- Mittler, R. 2002. Oxidative stress, antioxidants and stress tolerance. *Tren.Plant Sci.*, **7**: 405-410.
- Morimoto, S., Tateishi, N., Inuyama, M., Taura, F., Tanaka, H., and Shoyama, Y., 1999. Identification and molecular characterization of novel peroxidase with structural protein-like properties. *J. Biol. Chem.*, **274**: 26192-26198.
- Muthukrishnan, S., Liang, G. H., Trick, H. N., and Gill, B. S., 2001. Pathogenesis-related proteins and their genes in cereals. *Plant Cell Tiss. Organ Cul.*, **64**: 93-114.
- Otte, O., and Barz, W., 2000. Characterization and oxidative in vitro cross-linking of an extensin-like protein and a proline-rich protein purified from chickpea cell walls. *Phytochem.*, **53**: 1-5.
- Peberdy, J.F., 1988. Fungal cell walls – A review. In: *Biochemistry of Cell Walls and Membranes in Fungi*. Kuhn P.J., et al. (Eds.) Springer-Verlag: Berlin ets., 5-22.
- Peng, M., and Kuc, J., 1992. Peroxidase-generated hydrogen peroxide as a source of antifungal activity in vitro and on tobacco leaf disks. *Phytopath.*, **82**: 696-699.
- Rasmussen, J., Smith, J., Williams, S. Burkhart, W., Ward, E., Somerville, S. C., Ryals, J., and Hammerschmidt, R., 1995. cDNA cloning and systemic expression of acidic peroxidases associated with systemic acquired resistance to disease in cucumber. *Physiol. Mol. Plant Pathol.*, **46**: 389-400.
- Repka, V., and Jung, M., 1995. Organ-specific expression of the stress-related anionic peroxidases in cucumber flowers. *Biol. Plant.*, **37**: 523-531.
- Ride, J.R., 1980. The effect of induced lignification on the resistance of wheat cell walls to fungal degradation. *Physiol. Plant Pathol.*, **16**: 187-196.
- Schafer, P., Huckelhoven, R., and Kogel, K.-H., 2004. The white Barley mutant *Albostrains* shows a supersusceptible but symptom less interaction phenotype with the hemibiotrophic fungus *Bipolaris sorokiniana*. *Mol. Plant-Microbe Interact.*, **17**: 366-373.

- Shakirova, F.M., 2001. Nespetsificheskaya ustoichivost' rastenii k stressovym faktoram i ee regulyatsiya (Unspecific Plant Resistance to Stress Factors and Its Regulation), Ufa: Gilem, 52 p.
- Sharma, P.T.R., and Singh, B.M., 2002. Salicylic acid induced insensitivity to culture filtrate of *Fusarium oxysporum* f.sp. *zingiberi* in the calli of *Zingiber officinale* Roscoe. *Eur. J. Plant Pathol.*, **108**: 31-39.
- Siegel, S.M., 1957. Non - enzymic macromolecules as matrices in biological synthesis. The role of polysaccharides in peroxidase catalyzed lignin polymer formation from eugenol. *J. Amer. Chem. Soc.*, **79**: 1628-1632.
- Thordal-Christensen, H., Zang, Z., Wei, Y., and Collinge, D., 1997. Subcellular localization of H₂O₂ in plants. H₂O₂ accumulation in papillae and hypersensitive response during the barley - powdery mildew interaction. *Plant J.*, **11**: 1187-1194.
- Van der Westhuizen, A.J., Qian, X.M., and Botha, A.M., 1998. Differential induction of apoplastic peroxidase and chitinase activities in susceptible and resistant wheat cultivars by russian wheat aphid infestation. *Plant Cell Rep.*, **18**: 132-137.
- Wei, Y., Zhang, Z., Andersen, C.H., Schmelzer, E., Gregersen, P.L., Collinge, D.B., Smedegaard-Petersen, V., and Thordal-Christensen, H., 1998. An epidermis/papilla-specific oxalate oxidase-like protein in the defence response of barley attacked by the powdery mildew fungus. *Plant Mol. Biol.*, **36**: 101-112.
- Wojtaszek, P., and Bolwell, G.P., 1995. Secondary cell-wall-specific glycoprotein(s) from French bean (*Phaseolus vulgaris* L.). *Plant Physiol.*, **108**: 1001-1012.
- Yarullina, L. G., Maksimov, I. V., and Yamaleev, A. M., 1997. The protective role of lignification from wheat infestation by septoriosi. *Mikol. Fitopatol.*, **31**: 65-69.

Chapter 12

SALICYLIC ACID IN PLANT DISEASE RESISTANCE

RATNESH CHATURVEDI AND JYOTI SHAH

Division of Biology, Kansas State University, Manhattan, Kansas 66506, USA.

Abstract: Salicylic acid (SA) plays an important role in plant defense. Its role in plant disease resistance is well documented for dicotyledonous plants, where it is required for basal resistance against pathogens as well as for the inducible defense mechanism, systemic acquired resistance (SAR), which confers resistance against a broad-spectrum of pathogens. The activation of SAR is associated with the heightened level of expression of the pathogenesis-related proteins, some of which possess antimicrobial activity. Studies in the model plant *Arabidopsis thaliana* have provided important insights into the mechanism of SA signaling in plant defense. The NPR1 protein is an important component of SA signaling in Arabidopsis. Homologues of NPR1 are present in other plant species. NPR1 is also required for plant defense mechanisms that do not require SA. Hence, NPR1 provides an important link between different defense mechanisms. Similarly, cross talk between SA and other defense signaling pathways results in the fine-tuning of plant defense response. Recent discoveries have implicated an important role for lipids in SA signaling. We discuss the progress made in understanding SA biosynthesis and signaling, its cross talk with other mechanisms in plant defense and the practical utility in targeting this defense mechanism for enhancing disease resistance.

Key words: Cross talk, engineering disease resistance, pathogenesis-related, pathogen resistance, plant defense, systemic acquired resistance

1. INTRODUCTION

The therapeutic property of the phenolic compound salicylic acid (SA) (Figure 1) and its derivatives, collectively known as salicylates, has been

known since the early 4th century B.C., when Hippocrates prescribed willow bark, which is rich in salicylates, for pain relief during childbirth (Rainsford, 1984; Weissman, 1991). In modern times, aspirin (Figure 1), an acetylated derivative of SA, has been widely administered as an anti-inflammatory drug and for the reduction of threat of heart attacks and strokes in high risk patients. The action of salicylates in mammals has been ascribed to their ability to modulate levels of prostaglandins and leukotrienes by disrupting eicosanoic acid metabolism (Mitchell *et al.*, 1993). In plants, salicylates affect processes as diverse as flowering, thermogenesis and plant response to stress (Raskin, 1992; Shah and Klessig, 1999). During the last twenty years, significant progress has been made in understanding SA metabolism and signaling in plant defense and its interaction with other defense mechanisms. As much as these studies have provided insights into the functioning of SA in plant defense, they also underscore how much remains unknown on the complexities of SA signaling in plant defense against pathogens.

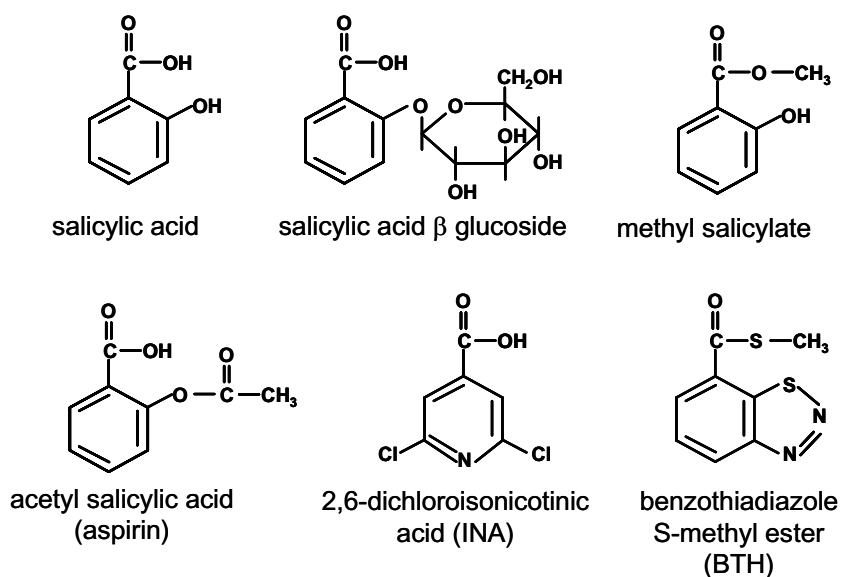

Figure 1. Salicylic acid and its derivatives, methyl salicylate and salicylic acid β glucoside, and its synthetic functional analogs, 2,6-dichloroisonicotinic acid (INA) and benzothiadiazole S-methyl ester (BTH).

2. PLANT-MICROBE INTERACTION

Plants are constantly being challenged by potential pathogens; however, disease is a relatively rare event. In part, this is because plants have evolved various mechanisms, both preformed and inducible, to protect themselves against pathogens. The perception by the plant of pathogen-associated molecular patterns (PAMPs) and pathogen-delivered effectors results in strengthening of existing defenses and the elicitation of inducible defense mechanisms (Gomez-Gomez and Boller, 2002; Nürnberger and Brunner, 2002; Parker, 2003; Shah, 2005). PAMPs, which are pathogen non-specific, elicit a general response from the host. In contrast, effectors may activate race-specific resistance. During the last two decades, several studies have characterized the interaction between effectors derived from a variety of pathogens and the host. These studies have resulted in the proposition of a gene-for-gene mechanism, which involves the specific recognition of the pathogen-derived effector molecule by a specific *R* (*Resistance*) gene in the plant (Dangl and Jones, 2001; Jones, 2001; Pink, 2002; McDowell and Woffenden, 2003; Belkhadir *et al.*, 2004). Although, the exact mechanism of this interaction between the effector molecule and the *R* gene encoded protein is unclear, this interaction results in the timely activation of downstream signaling mechanisms leading to resistance. In this type of incompatible interaction, which does not result in disease, the specific race of pathogen is called an avirulent pathogen and the corresponding plant cultivar, resistant. In contrast, a compatible interaction that occurs in the absence of gene-for gene recognition, results in disease, and the pathogen is referred to as a virulent pathogen and the plant a susceptible host.

During an incompatible interaction, local response to pathogens may include changes in ion fluxes, oxidative bursts, altered gene expression, and programmed death of host cells, often referred to as a hypersensitive response (HR) (Lam *et al.*, 2001; Lam, 2004). In addition to restricting growth and spread of pathogen, the cells undergoing programmed cell death (PCD) produce signals that activate defense responses in adjacent cells. The initial stimulus can be subsequently amplified by secondary signal molecules produced in the plant. SA, ethylene and jasmonic acid (JA), and its derivatives, are signal molecules involved in the amplification of plant defense responses (Shah and Klessig, 1999; Feys *et al.*, 2001; Pieterse *et al.*, 2001; Turner *et al.*, 2002; Wang *et al.*, 2002; Devoto and Turner, 2003; Shah, 2003). Synergistic and antagonistic interactions between SA, ethylene and JA signaling fine-tune plant defense response (Feys *et al.*, 2001; Pieterse *et al.*, 2001; Kunkel and Brooks, 2002; Wang *et al.*, 2002). However, some of these antagonistic interactions may be exploited by certain pathogens to promote parasitism.

In several cases, the initial exposure to a pathogen can confer enhanced resistance in other parts of the plant to subsequent challenge by pathogens (Van Loon, 2000; Pieterse *et al.*, 2002; Durrant and Dong, 2004). Systemic acquired resistance (SAR) is one such inducible defense mechanism, which is induced systemically throughout the plant in response to the exposure of another part of the plant to a necrogenic pathogen (Ryals *et al.*, 1996; Sticher *et al.*, 1997; Durrant and Dong, 2004). It is believed that a phloem mobile signal generated in the pathogen-inoculated organ traverses to the distal organs where it promotes the activation of SAR, conferring enhanced resistance against a broad-spectrum of pathogens (Ryals *et al.*, 1996; Sticher *et al.*, 1997; Durrant and Dong, 2004). Associated with the manifestation of HR and SAR is the elevated expression of several pathogenesis-related (*PR*) genes, some of which encode antimicrobial proteins. Furthermore, the induced expression of *PR* genes correlates with the activation of defense responses; they serve as excellent molecular markers of plant defense (Gilbert *et al.*, 1996; Glazebrook *et al.*, 1996; Falk *et al.*, 1999; Belfanti *et al.*, 2004).

3. SALICYLIC ACID - AN IMPORTANT SIGNAL MOLECULE IN PLANT DISEASE RESISTANCE

The involvement of SA in defense signaling has been extensively characterized in dicotyledonous plants. Nearly 25 years ago, White and colleagues reported that SA and aspirin application could induce resistance against tobacco mosaic virus (TMV) in tobacco (White 1979; Antoniw and White, 1980). Since then, application of SA and its functional analogs, for example, 2,6-dichloroisonicotinic acid (INA) and benzothiadiazole S-methyl ester (BTH) have been found to induce expression of the *PR* genes and resistance against viral, bacterial, oomycete and fungal pathogens in a variety of dicotyledonous (Malamy and Klessig, 1992; Ryals *et al.*, 1996; Shah and Klessig, 1999) and monocotyledonous plants (Wasternack *et al.*, 1994; Kogel *et al.*, 1994; Gorlach *et al.*, 1996; Morris *et al.*, 1998; Pasquer *et al.*, 2005; Makandar *et al.*, 2006). In case of viruses, SA promotes the inhibition of viral replication, cell-to-cell movement and also long-distance movement (Singh *et al.*, 2004). SA has been shown to modulate HR-associated cell death, reactive oxygen species (ROS) level, activation of lipid peroxidation and generation of free radicals, all of which could potentially influence plant defense against pathogens (Dempsey *et al.*, 1999; Shah and Klessig, 1999). SA at low concentrations also promotes the faster and stronger activation of callose deposition and gene expression in response to pathogen or microbial elicitors, a process called 'priming', which contributes

to induced defense mechanisms (Kohler *et al.*, 2002). The first evidence that SA is an endogenous signal molecule in plant defense came from studies with pathogen challenged tobacco and cucumber plants. SA levels increased 20-50 fold in leaves of the TMV-resistant tobacco variety, *Nicotiana tabaccum* cv *Xanthi* nc, upon challenge with TMV (Malamy *et al.*, 1990); smaller increases in SA level were also found in the uninoculated leaves that exhibited SAR. Similarly, 10-100 fold increases in SA levels were found in the phloem sap of cucumber plants infected with *Colletotrichum lagenarium*, *Pseudomonas syringae* or Tobacco necrosis virus (Mettraux *et al.*, 1990; Rasmussen *et al.*, 1991; Smith *et al.*, 1991). In these studies, the increases in endogenous levels of SA either paralleled or preceded the increase in expression of *PR* genes and development of SAR. Since then, increases in SA level (500 – 2000 ng g⁻¹ fresh weight) have been reported in pathogen challenged leaves of various other monocotyledonous and dicotyledonous plant species (Delaney *et al.*, 1994, 1995; Summermatter *et al.*, 1995; Shah *et al.*, 1997; Vallelian-Binschedler *et al.*, 1998). An exception is rice, in which pathogen infection does not result in an increase in SA level (Silverman *et al.*, 1995). Furthermore, exogenously applied SA is not a good inducer of *PR* gene expression and disease resistance in rice. Interestingly, the basal level of SA in rice (5,000 – 30,000 ng g⁻¹ fresh weight) is two orders of magnitudes higher than the basal level of SA in *Arabidopsis*, tobacco and wheat. Furthermore, these levels in rice are higher than the level of SA found after pathogen infection in many other plant species (Silverman *et al.*, 1995; Chen *et al.*, 1997; Yang *et al.*, 2004). However, Silverman *et al.* (1995) have reported a tight correlation between the level of resistance to rice blast caused by *Magnaporthe grisea* and the endogenous levels of SA amongst rice cultivars; those with the highest level of SA exhibited the highest level of resistance to the fungus, suggesting that SA does contribute to rice defense against the blast fungus. The importance of SA in resistance to rice blast was further confirmed in transgenic plants that were unable to accumulate SA (Yang *et al.*, 2004). Like rice, SA levels are constitutively high in potato, and SA application does not enhance disease resistance in potato. But like in rice, endogenous SA has an important role in defense against the potato late blight pathogen, *Phytophthora infestans* (Coquoz *et al.*, 1995). It has been suggested that in rice and potato the factor limiting activation of SA dependent responses is not SA accumulation, but rather a component of the signal transduction pathway downstream of SA (Yu *et al.*, 1997). This may explain why SA application does not induce defense responses in these plants. Indeed constitutive expression of the *NPRI* (*NON-EXPRESSOR OF PRI*) gene, which is a key component of SA signaling in *Arabidopsis* (see below), results in constitutive expression of SA-regulated defenses in transgenic rice

(Chern *et al.*, 2001; Fitzgerald *et al.*, 2004). Elevated levels of SA and constitutive expression of the *PR* genes also correlated with elevated resistance to TMV in a *Nicotiana glutinosa* x *N. debneyi* hybrid (Yalpani *et al.*, 1993), and resistance to bacterial and oomycete pathogens in the *Arabidopsis thaliana* *cpr*, *ssi* and *acd* mutants (Bowling *et al.*, 1994, 1997; Rate *et al.*, 1999; Shah *et al.*, 1999, 2001; Clarke *et al.*, 2000; Brodersen *et al.*, 2002; Shirano *et al.*, 2002).

Additional evidence for the involvement of SA in plant defense came from studies with transgenic tobacco and Arabidopsis plants that express a SA degrading enzyme, salicylate hydroxylase, encoded by the *Pseudomonas putida nahG* gene, which converts SA to catechol. These plants were unable to accumulate high levels of SA when challenged by pathogen (Gaffney *et al.*, 1993; Delaney *et al.*, 1994). In these transgenic NahG plants, pathogen induced expression of the *PR* genes and resistance to avirulent pathogens was compromised (Gaffney *et al.*, 1993; Delaney *et al.*, 1994). Expression of salicylate hydroxylase also enhances disease in compatible interactions. *nahG* expression also reduced the basal level of SA in rice, resulting in enhanced susceptibility against avirulent races of *M. grisea* and a reduction in age dependent resistance against virulent strains of *M. grisea* (Yang *et al.*, 2004). The ability of INA and BTH to restore resistance in SA depleted transgenic NahG tobacco (Friedrich *et al.*, 1996) and Arabidopsis (Lawton *et al.*, 1996) plants further confirmed the importance of SA in disease resistance. However, recently some concerns have been raised on the use of the *nahG* gene in transgenic plants as an exclusive means to test the involvement of SA in plant defense. Catechol, the product of salicylate hydroxylase catalyzed degradation of SA, has been shown to enhance growth of the bean pathogen *Pseudomonas syringae* pv *phaseolicola* in Arabidopsis, which is normally not a host for this pathogen (Van Wees and Glazebrook, 2003). Catechol application causes production of reactive oxygen species (ROS) in animals (Schweigert *et al.*, 2001). Similarly, in plants, catechol could cause the production of ROS, which could affect plant defense response. Indeed, the effect of catechol on growth of *P. syringae* pv *phaseolicola* could be reversed by the application of catalase, which degrades hydrogen peroxide, suggesting that catechol-induced production of hydrogen peroxide may be involved in the *nahG* transgene-conferred loss of non-host resistance against *P. syringae* pv *phaseolicola* in Arabidopsis (Van Wees and Glazebrook, 2003).

Blocking SA synthesis is another approach that has been utilized to evaluate its role in plant defense. For example, application of 2-aminoindan-2-phosphonic acid, which is an inhibitor of phenylalanine ammonia-lyase (PAL) activity, prevented SA accumulation and simultaneously resulted in the conversion of an otherwise resistant *Arabidopsis* plant into a plant that is

susceptible to an avirulent race of the oomycete pathogen *Peronospora parasitica* (recently renamed as *Hyaloperonospora parasitica*) (Mauch-Mani and Slusarenko, 1996). However, resistance could be restored by the application of SA to these 2-aminoindan-2-phosphonic acid treated plants. More recently, mutations in the Arabidopsis *SID2* and *EDS5* genes, which are required for SA synthesis (see below), were shown to enhance susceptibility to bacterial and oomycete pathogens (Nawrath *et al.*, 1999, 2002; Wildermuth *et al.*, 2001). SA application restored resistance in the *sid2* and *eds5* mutants thus confirming the importance of SA in plant defense.

Although the exact mechanism by which SA confers enhanced resistance to pathogens is unclear, SA affects the activity of mitochondrial alternative oxidase. Alternative oxidase is an enzyme that directly links the oxidation of the ubiquinol/ubiquinone pool in mitochondria to the reduction of oxygen to water, without the synthesis of ATP. This ability of SA to affect alternative oxidase has been associated with SA mediated resistance to some viruses (Singh *et al.*, 2004). It has been suggested that SA action on the alternative oxidase capacity could affect ROS levels in the mitochondria, which in turn could activate antiviral defenses (Singh *et al.*, 2004). SA also binds enzymes like catalase, ascorbate peroxidase, aconitase and a carbonic anhydrase from tobacco (Chen *et al.*, 1993; Durner and Klessig, 1995; Ruffer *et al.*, 1999; Slaymaker *et al.*, 2002). Some of these enzymes are involved in the metabolism of reactive oxygen species (ROS) and in REDOX homeostasis. REDOX changes are associated with plant defense responses (Mittler, 2002; Torres *et al.*, 2002; Durrant and Dong, 2004). SA binding affects the biochemical activity of catalase and ascorbate peroxidase (Chen *et al.*, 1993; Durner and Klessig, 1995) and may have a role in the vicinity of the HR, where SA concentrations are high. In addition, SA also affects lipid peroxidation, which may have a role in plant defense (Anderson *et al.*, 1998). Indeed, genetic studies in Arabidopsis have demonstrated that genes associated with lipid metabolism and putative lipid transfer proteins are required for SAR (Maldonado *et al.*, 2002; Nandi *et al.*, 2004; Shah, 2005).

4. SALICYLIC ACID METABOLISM IN PLANT DEFENSE

At least two routes for SA biosynthesis in plant defense against pathogen have been documented (Sticher *et al.*, 1997; Verberne *et al.*, 1999; Métraux, 2002; Shah, 2003) (Figure 2). In some bacteria, SA is synthesized from chorismate via isochorismate in two steps involving the enzymes

isochorismate synthase (ICS) and isochorismate pyruvate lyase (IPL). Overexpression of these two bacterial enzymes in transgenic plants enhances SA accumulation, suggesting that plants do have the ability to synthesize SA from chorismate (Serino *et al.*, 1995; Mauch-Mani *et al.*, 2001). Indeed, a recent study of the *SID2* (*SALICYLIC ACID INDUCTION-DEFICIENT2*) gene (also referred to as *ENHANCED DISEASE SUSCEPTIBILITY16* [*EDS16*]) has confirmed the presence of a similar SA biosynthesis mechanism in Arabidopsis. *SID2/EDS16* encodes a protein with homology to bacterial ICS (Wildermuth *et al.*, 2001). In response to pathogen infection, the *sid2/eds16* mutant plants accumulate only 5-10% of wild type levels of SA. Furthermore, these mutants exhibit enhanced susceptibility to pathogens and are compromised in their ability to activate SAR. SA application complemented the enhanced disease susceptibility phenotype associated with the *sid2/eds16* mutants. These experiments demonstrated that the isochorismate pathway in Arabidopsis is the main source of SA synthesis during plant-pathogen interaction. The presence of plastid transit peptide and cleavage site in the *SID2* protein indicates that SA may be synthesized in the plastids and supports the notion that the *SID2*-dependent SA biosynthesis pathway may have been derived evolutionarily from prokaryotic endosymbionts. The *EDS5/SID1* protein, which is also required for SA synthesis in pathogen-infected Arabidopsis, is also predicted to localize to the chloroplast. *EDS5* has homology to animal multidrug and toxin extrusion (MATE) family of transporter proteins, which are involved in moving organic molecules across membranes (Nawrath *et al.*, 2002). *EDS5* may be involved in the transport of phenolic compound(s) involved in SA biosynthesis, across the chloroplastic membrane. The chloroplast may also be the site for SA action; one of the SA binding proteins, *SABP3*, which is involved in the development of the HR, is localized in the chloroplast (Slaymaker *et al.*, 2002). Furthermore, mutations in several Arabidopsis genes that encode chloroplast localized proteins impact SA synthesis and signaling (Shah, 2003), suggesting that chloroplast has an important role in SA synthesis/signaling.

SA is also synthesized by the phenylpropanoid pathway, which also feeds into the synthesis of phytoalexins, coumarins and lignins (Sticher *et al.*, 1997; Verberne *et al.*, 1999; Métraux, 2002; Shah, 2003). SA biosynthesis via this pathway begins with phenylalanine. PAL (phenylalanine ammonia lyase), which catalyzes the conversion of phenylalanine to *trans*-cinnamic acid (Sticher *et al.*, 1997; Verberne *et al.*, 1999). Subsequently, *trans*-cinnamic acid is hydroxylated to form *ortho*-coumaric acid followed by oxidation of the side chain to yield SA. Alternatively, the side chain of *trans*-cinnamic acid can be initially oxidized to give benzoic acid, which is then hydroxylated by benzoic acid-2-hydroxylase (*BA2H*) in the *ortho*-

position to give SA. In tobacco, the activity of a partially purified BA2H was strongly induced by BA application and in response to TMV infection, suggesting that this pathway may be involved in tobacco response to TMV (Léon *et al.*, 1995b). The biochemical mechanism by which benzoic acid is generated from *trans*-cinnamic acid is poorly understood; it has been suggested that this may involve a mechanism analogous to β -oxidation of fatty acids, involving benzaldehyde as an intermediate (Ribnicky *et al.*, 1998). Besides tobacco, the synthesis of SA from *trans*-cinnamic acid has also been documented in cucumber, potato and rice (Sticher *et al.*, 1997). Expression of *PAL* is rapidly induced during plant-pathogen interaction, and as mentioned above, the inhibition of *PAL* activity resulted in the breakdown of an incompatible interaction between Arabidopsis and *Hyaloperonospora parasitica* (Mauch-Mani and Slusarenko, 1996). SA application complemented the defense phenotype of these *PAL*-inhibited plants, suggesting an important role for *PAL* in localized defense against this oomycete pathogen. In Arabidopsis, SA derived from isochorismate, the major SA biosynthesis mechanism, may be important for sustained SA synthesis during the manifestation of SAR (Wildermuth *et al.*, 2001). In contrast, the phenylpropanoid pathway may be responsible for the residual SA observed in the absence of ICS activity, in the Arabidopsis *sid2* mutant, and for the rapid production of SA associated with the HR.

In plants like tobacco and Arabidopsis, SA can also be found as its glucose derivative, salicylic acid- β -glucoside (SAG). Glucose derivatives of SA have also been reported in cucumber (Meuwly *et al.*, 1995) and rice (Silverman *et al.*, 1995). Likewise, benzoic acid can also be found conjugated to glucose, for example as benzoyl-glucose. In tobacco SA can also be released from benzoyl-glucose during the elicitation of defense responses (Chong *et al.*, 2001). The enzyme responsible for conjugating glucose with SA, and possibly benzoic acid, is UDP-glucose:SA glucosyltransferase (SAGT). SAGT from oat and tobacco have high specificity for SA as a substrate (Yalpani *et al.*, 1992; Lee *et al.*, 1995). In addition, SA induces their activities. Furthermore, in tobacco, expression of the gene encoding this enzyme is induced during pathogen-infection (Enyedi and Raskin, 1993). Although, in tobacco SAG application can induce expression of the *PR1* gene, it is believed that this induction was most likely mediated via SA, released from the hydrolysis of SAG by a cell wall associated β -glucosidase (Hennig *et al.*, 1993). Similar to many other plant hormones, SAG may provide a storage form of SA or a means to remove free SA.

Methyl-SA (MeSA), which is produced from SA, also accumulates during pathogen infection of plants (Sticher *et al.*, 1997). It was proposed that MeSA, which is volatile, may function as an airborne signal for

activating plant defense responses (Shulaev *et al.*, 1997). A gene, which encodes a methyltransferase that synthesizes MeSA was recently identified in *Arabidopsis* (Chen *et al.*, 2003). MeSA could be hydrolyzed by esterases to release SA. Recently, the tobacco SA-binding protein 2 (SABP2), which exhibits homology to acyl-hydrolases, was shown to possess MeSA esterase activity. SABP2 is required for basal resistance to TMV in a TMV-resistant tobacco variety (Kumar and Klessig, 2003). Furthermore, SA binding stimulated the acyl-hydrolase activity of SABP2, suggesting that SABP2 is required subsequent to SA accumulation in plant defense. SABP2 may be involved in the response of plant cells to exogenously perceived MeSA.

4.1 Regulation of SA biosynthesis in plant defense

SA biosynthesis associated with plant defense is tightly regulated. Expressions of the *SID2*, *EDS5* and *PAL* genes that are involved in SA biosynthesis are induced when plants are challenged with pathogen. Similarly, the activity of tobacco BA2H is activated in response to TMV infection (Léon *et al.*, 1995a). SA accumulation during gene-for-gene resistance conferred by several *Arabidopsis* *R* genes requires the *EDS1* and *PAD4* genes (Wiermer *et al.*, 2005). Expression of *EDS1* and *PAD4* are also induced during pathogen infection. Interestingly, *EDS1* and *PAD4* expression can also be induced by SA application suggesting the involvement of the EDS1 and PAD4 proteins in positive feedback regulation of SA synthesis. The EDS1 and PAD4 proteins physically interact, suggesting that EDS1 in association with PAD4 amplifies SA synthesis (Wiermer *et al.*, 2005). EDS1 and PAD4 influence each other's expression in pathogen-infected plants and also influence the stability of each other (Feys *et al.*, 2005). Although the mechanism by which EDS1 and PAD4 influence SA synthesis is not known, the EDS1-PAD4 protein complex was found to co-localize to the nucleus, suggesting a role of this complex in the nucleus (Feys *et al.*, 2005). *ALD1* is another *Arabidopsis* gene that is potentially part of a feedback loop affecting SA synthesis (Song *et al.*, 2004). Like the *pad4* mutant plant, pathogen induced SA synthesis is blocked in the *ald1* mutant. Furthermore, the *ald1* mutant exhibits heightened susceptibility to virulent and avirulent pathogens. *ALD1* and *PAD4* modulate the expression of each other. SA is also known to induce the expression the *R* gene, *RPW8*, and some others that belong to the toll-interleukin-2 receptor (TIR)-NBS-LRR type *R* genes (Xiao *et al.*, 2003). Furthermore, SA also potentiates the expression of the *PAL* gene in response to pathogen derived elicitors (Kohler *et al.*, 2002), suggesting that positive feedback regulation by SA may be exerted at multiple steps upstream of SA synthesis.

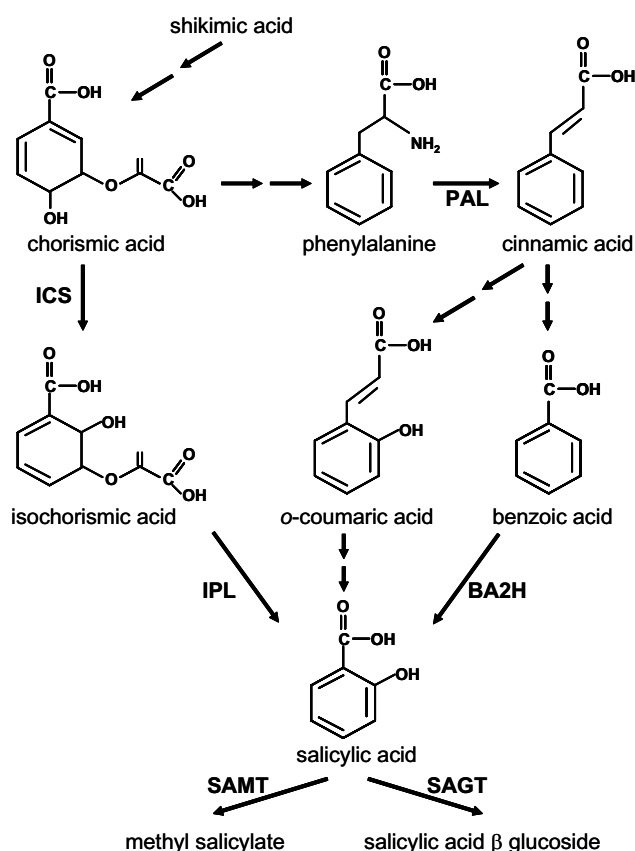

Figure 2. Salicylic acid biosynthesis pathways in plants. The shikimate pathway provides chorismic acid, which can be converted into salicylic acid, via two mechanisms. In the first mechanism, salicylic acid is synthesized from isochorismic acid. The Arabidopsis SID2 gene encodes a predicted isochorismate synthase (ICS). The SID2-encoded ICS is proposed to catalyze the conversion of chorismic acid to isochorismic acid. By analogy to the mechanism of SA biosynthesis in bacteria, it is suggested that an isochorismate pyruvate lyase (IPL) catalyzes the conversion of isochorismic acid to salicylic acid. In the second mechanism, phenylalanine, which is derived from chorismic acid, is first deaminated by phenylalanine ammonia lyase (PAL) to yield cinnamic acid. Cinnamic acid is subsequently converted into benzoic acid. Salicylic acid is then synthesized from benzoic acid by benzoic acid 2-hydroxylase (BA2H). In an alternative pathway, salicylic acid is synthesized from cinnamic acid via o-coumaric acid. The enzyme salicylic acid methyl transferase (SAMT) synthesizes methyl salicylate from salicylic acid, while the enzyme salicylic acid glucosyl transferase (SAGT) catalyzes the glycosylation of salicylic acid to yield salicylic acid β glucoside.

Treatment of tobacco with high concentrations (>300 mM) of hydrogen peroxide resulted in a dose-dependent accumulation of SA (Leon *et al.*, 1995a; Neuenschwander *et al.*, 1995). In addition, high concentration of SA can potentially increase the accumulation of hydrogen peroxide as a result of inhibition of the H₂O₂-scavenging activities of catalase and ascorbate peroxidase by SA binding to these enzymes (Chen *et al.*, 1993; Durner and Klessig, 1995). In soybean suspension cells, presence of SA potentiated the production of ROS and HR cell death in response to the bacterial pathogen, *Pseudomonas syringae* (Shirasu *et al.*, 1997; Tenhaken *et al.*, 1997). These observations suggest that SA synthesis may also be influenced by a signal amplification loop involving reactive oxygen species (ROS) (Shirasu *et al.*, 1997). However, considering that very high concentrations of SA are required to inhibit catalase and ascorbate peroxidase activity, the biological significance of such a loop in cells distal to the HR is unclear. Positive feedback loops like the once described above may be important for amplifying plant defense responses and provide a point for integrating environmental and developmental signals that influence plant defense responses. Indeed, plant age and environmental factors like light, humidity and ozone levels are known to influence the activation of SA-regulated mechanisms (Yoshioka *et al.*, 2001; Genoud *et al.*, 2002; Hua *et al.*, 2001; Kus *et al.*, 2002; Mateo *et al.*, 2004).

SA synthesis is also under negative feedback regulation. SA levels and *SID2* expression were higher in pathogen-inoculated Arabidopsis *npr1* mutant plants than the wild type plant (Delaney *et al.*, 1995; Shah *et al.*, 1997; Wildermuth *et al.*, 2001). As described below, *NPR1* gene is required for SA signaling. Likewise, the presence of the wild type *NPR1* gene also influenced the constitutive high levels of SA in the Arabidopsis *ssi1*, *ssi2* and *cpr* mutants; SA levels were higher in the *npr1* mutant background than the *NPR1* background (Shah *et al.*, 1999, 2001; Clarke *et al.*, 2000). High levels of SA are known to compromise other signaling mechanisms that contribute to defense against other pathogens (Bostock, 2005). Furthermore, the accumulation of high level of SA in several Arabidopsis mutants is associated with adverse growth phenotypes, for example dwarfing and cell death. These observations suggest that high level of SA accumulation and activation of downstream signaling results in the diversion of resources from plant growth and development. Indeed, BTH application in field grown plants in the absence of pathogen results in lowered seed yield than in untreated plants (Heil *et al.*, 2000), and the repeated spraying with BTH retards growth of wild type plants (Durrant and Dong, 2004). Hence, regulating SA synthesis may be critical for plant growth, development and fitness under stress. A combination of positive and negative regulatory mechanisms allows for tighter regulation of SA synthesis and fine-tuning of

plant defense responses. Moreover, such a feedback regulation will also allow for defense responses to be dampened once the threat of infection has subsided.

5. SALICYLIC ACID SIGNAL TRANSDUCTION IN PLANT DEFENSE

Biochemical screens set up to identify the SA receptor have identified several SA-binding proteins from tobacco. The hydrogen peroxide scavenging enzymes, catalase and ascorbate peroxidase were identified as SA-binding proteins in these screens (Chen *et al.*, 1993; Durner and Klessig, 1995). It was proposed that SA exerts its effect by inhibiting these enzymes and thus increasing ROS levels. However, the affinity of these enzymes for SA is not high and the level of SA (0.5 – 10 μ M) found in the tissues exhibiting SAR is probably not sufficient to inhibit catalase and ascorbate peroxidase activities. In addition, in several other studies SA application was not found to result in the accumulation of ROS (Neuenschwander *et al.*, 1995; Allan and Fluhr, 1997) and no decrease in catalase activity was observed in pathogen inoculated tobacco or SA-treated leaf discs (Bi *et al.*, 1995). Furthermore, SA is capable of binding other iron containing enzymes of plant and non-plant origin (Rüffer *et al.*, 1995). Moreover, other studies have shown that ROS functions upstream of SA and not downstream of SA (Bi *et al.*, 1995; Neuenschwander *et al.*, 1995; Du and Klessig, 1997; Takahashi *et al.*, 1997; Chamnongpol *et al.*, 1998). SA binding protein 3 (SABP3), which encodes an enzyme with homology to carbonic anhydrase also binds SA ($K_d = 3\text{--}4 \mu\text{M}$) (Slaymaker *et al.*, 2002). RNAi silencing of SABP3 expression compromised HR in tobacco. However, since SA binding did not affect SABP3's carbonic anhydrase activity it was suggested that SABP3's carbonic anhydrase activity is not critical for its role in plant defense. SABP3 also has an antioxidant activity. It remains to be determined if SABP3's role in plant defense is associated with its antioxidant activity. The only high affinity SA-binding protein known to date is SABP2 ($K_d = 90 \text{ nM}$) (Du and Klessig, 1997; Kumar and Klessig, 2003). Suppression of SABP2 expression compromised gene-for-gene resistance against TMV (Kumar and Klessig, 2003). Crystal structure and biochemical analysis revealed an acyl hydrolase activity for SABP2, with methyl salicylate as a substrate and SA as a product inhibitor (Forouhar *et al.*, 2005). The activity of SABP2 against artificial substrates was stimulated by SA binding (Kumar and Klessig, 2003). SABP2's involvement in plant defense may have to do with processing MeSA. However, the presence of other lipid substrates of this enzyme that may also be involved in plant

defense cannot be ruled out. Although the above studies have not uncovered a classical high affinity receptor for SA, they do underscore the complexities associated with these biochemical approaches.

5.1 NPR1-dependent salicylic acid signaling

Various genetic screens in *Arabidopsis* have identified genes that are potentially involved in SA signaling. Mutations in the *NPR1* gene, also known as *NIM1* (*NON-INDUCIBLE IMMUNITY 1*) and *SAII* (*SALICYLIC ACID-INSENSITIVE 1*), were independently identified in several studies in screens for mutants that were non-responsive to SA and its analogs, or in screens for enhanced disease susceptibility mutants (Cao *et al.*, 1994; Delaney *et al.*, 1995; Glazebrook *et al.*, 1996; Shah *et al.*, 1997). In comparison to the wild type plant, in the *npr1* mutant, the *PR1* gene is induced poorly after SA application and slowly after pathogen infection. Furthermore, basal resistance to virulent and some avirulent pathogens and SAR were compromised in *npr1* plants (Durrant and Dong, 2004). NPR1 protein does not bind SA, indicating that it is not a receptor for SAR. Expression of the *NPR1* gene is induced 2-3 fold after treatment with SA or pathogen infection (Cao *et al.*, 1997; Ryals *et al.*, 1997). The NPR1 promoter contains binding sites (W-boxes) for the WRKY family of DNA binding proteins. Mutation in the W-box in the promoter of the *NPR1* gene adversely affected expression of *NPR1*, suggesting that a WRKY transcription factor(s) is involved in the expression of *NPR1* (Yu *et al.*, 2001).

SA and its functional analogs also stimulate the movement of NPR1 protein from the cytosol to the nucleus. Likewise, NPR1 protein also get localized into the nucleus in response to pathogen infection (Kinkema *et al.*, 2000). Nuclear localization of the NPR1 protein is critical for the activation of SAR. Recently, it was shown that the movement of the NPR1 protein into the nucleus may be sensitive to SA induced changes in cellular redox status. The positions of ten Cys residues, some of which may be prone to oxidation/reduction, are conserved amongst NPR1 proteins from different species. Mou *et al.* (2003) showed that in extracts from untreated plants NPR1 protein was found as a large complex; the monomeric form was only detected when the plants were treated with INA, a functional analog of SA, or after pathogen infection. Replacement of one of the Cys with Ala caused the NPR1 monomer to accumulate constitutively and localize to the nucleus in uninduced plants. Moreover, these plants constitutively expressed the *PR1* gene. Mou *et al.* (2003) further observed that the activation of SAR is associated with changes in redox state; following SAR induction with INA there was a rapid oxidative burst. The cellular redox status then recovered

and rebounded to a relatively reduced environment. The appearance of the NPR1 monomer was accompanied with this transition to the reduced condition. These results demonstrate that the NPR1 monomer is the biologically active form and that the transition of oligomer to monomer controls NPR1 nuclear transport and the activation of *PR* genes.

NPR1 itself does not exhibit DNA binding activity. However, NPR1 was found to interact with the TGA family of DNA binding proteins in yeast two hybrid assays and in immunoprecipitation assays (Durrant and Dong, 2004). The TGA factors bind to *activator sequence-1 (as-1)*, which is present in the promoter of the *PR1* gene. *PR1* promoter has two such elements, *LS5* and *LS7* (Lebel *et al.*, 1998). While *LS7* is a positive regulatory element required for high level expression of *PR-1*, *LS5* is a negative regulatory element. Using gel-mobility shift assays it was shown that TGA2 and TGA4 could bind the *LS7* element, whereas only TGA2 could bind the *LS5* element (Despres *et al.*, 2000). Furthermore, binding of TGA to *LS7* was enhanced in the presence of NPR1. These results suggest that NPR1 may enhance the DNA binding activity of some TGA proteins and thus affects expression of *PR1* gene. Chromatin immunoprecipitation studies confirmed that the TGA2 factor is recruited to the *PR1* promoter only after being treated with SA but not in untreated plants or in SA treated *npr1* mutant plants (Johnson *et al.*, 2003). Mutational analysis of *TGA* genes indicated redundancy in the function of these factors in SA signaling. Mutations in the *TGA2*, *TGA5* and *TGA6* genes had no impact on SA signaling. However, like the *npr1* mutant, SAR was compromised in the *tga2 tga5 tga6* triple mutant plant (Zhang *et al.*, 2003). However, unlike the *npr1* mutant, basal resistance to *P. syringae* remained unaffected in *tga2 tga5 tga6* triple mutant, suggesting additional redundancy amongst TGA factors, or alternatively, the involvement of other TGA factors in basal resistance. Interestingly, like NPR1, activity of some TGA proteins is also regulated by the redox state of the cell. Despres *et al.* (2003) demonstrated that in leaves of untreated plants the TGA1 protein exists in both reduced and oxidized form. However, only the reduced form was detected after SA treatment. This reduction in TGA1 presumably increases its DNA binding activity by promoting its interaction with NPR1, as mutations in Cys residues in TGA1 enhanced its *in vitro* interaction with NPR1. The question of how SA, which is known to induce an oxidative burst, promotes the reduced state is not clear. Perhaps the oxidative burst induced in response to SA results in the activation of antioxidant mechanisms, which not only protect the cell from oxidative damage, but also result in an overall reduced state that leads to the activation of SAR. Indeed, some of the genes (e.g. glutathione-S-transferase) expressed at elevated levels subsequent to the oxidative burst induced by SA are those involved in protecting the plant against oxidative stress (Uquillas *et al.*, 2004). It has

been suggested that glucose-6-phosphate-1-dehydrogenase is possibly involved in providing the reducing equivalents for the reduction of NPR1 during the activation of SAR (Dong, 2004).

Recently, it was shown that in addition to controlling the expression of the *PR* genes, NPR1 also controls the expression of genes that encode proteins associated with the protein secretory pathway. The expression of these genes is induced in response to pathogen infection. Mutations in some of these genes compromised resistance and were associated with the diminished secretion of PR proteins (e.g. PR1) into the apoplast (Wang *et al.*, 2005).

5.2 NPR1-independent salicylic acid signaling

Several studies have suggested that SA signaling is also mediated via an NPR1-independent mechanism. Gene-for gene resistance to certain cultivars of *P. syringae* and *H. parasitica* biotypes was effectively compromised by the expression of the *nahG* encoded salicylate hydroxylase, but not in the *npr1* mutant (Raridan and Delaney, 2000). Similarly, gene-for-gene resistance in Arabidopsis, to Turnip crinkle virus (TCV) and Cucumber mosaic virus-Y (CMV-Y), conferred by the *HRT* and *RCY1* genes, respectively, were suppressed by *nahG*, but not *npr1* (Kachroo *et al.*, 2001; Takahashi *et al.*, 2002). Presence of NPR1-independent SA signaling mechanism is also implicated by studies of the Arabidopsis *ssi2* mutant. In the *ssi2* mutant, which constitutively accumulates elevated level of SA, the *PR* genes were constitutively expressed even in the absence of a functional NPR1 gene (Clarke *et al.*, 2000; Shah *et al.*, 2001). Moreover, the *ssi2 npr1* mutant plant retained some of the *ssi2*-conferred resistance against bacterial and oomycete pathogens. Furthermore, the presence of *ssi2* mutant allele enhanced resistance to CMV-Y (Sekine *et al.*, 2004) and TCV (Chandra Shekara *et al.*, 2004). However, *ssi2*-conferred resistance against CMV-Y and *P. syringae* was compromised in the SA-deficient *ssi2 nahG* plant (Shah *et al.* 2001; Takahashi *et al.*, 2002; Sekine *et al.* 2004), suggesting the involvement of an NPR1-independent SA-signaling mechanism in *ssi2*. Similarly, NPR1-independent, SA-dependent defense mechanisms are also activated in the Arabidopsis *cpr5*, *cpr6*, *ssi1* and *hrl1* mutants (Shah *et al.*, 1999; Clarke *et al.*, 2000; Devadas *et al.*, 2002). In case of the *cpr5* and *cpr6* mutants it was shown that ethylene and JA signaling are involved in the expression of the NPR1-independent resistance (Clarke *et al.*, 2000). Ethylene signaling was also required for *hrl1*-conferred resistance (Devadas *et al.*, 2002). Similarly, ethylene and JA signaling have also been shown to be involved in local resistance during an incompatible interaction (Clarke *et al.*, 2000). Application of SA or BTH is not sufficient to activate *PR1*

expression and resistance in the *npr1* mutant plant. This suggests that SA on the outside is perceived differently than being synthesized within a cell. Alternatively, in addition to SA, another pathogen-induced signal may be required for the activation of the NPR1-independent mechanism in the above mutants. The *ssi1*, *ssi2*, *cpr5* and *hrl1* mutants also manifest a spontaneous cell death phenotype, which exhibits some similarity to the hypersensitive response (HR) that occurs in response to avirulent pathogens. It is possible that the HR-like cell death that is observed in the *ssi1*, *ssi2*, *cpr5* and *hrl1* mutants provides the second signal required for the activation of the NPR1-independent SA signaling pathway.

The activation of NPR1-independent, SA dependent defense mechanism was reported in the Arabidopsis *sn1l* mutant, which constitutively expresses *PR1* gene and resistance against biotrophic and oomycete pathogens in the absence of *NPR1* (Li *et al.*, 1999). It was suggested that SNI1 is a repressor of *PR* gene expression. Indeed, when expressed in yeast as a fusion with the GAL4-DNA binding domain, SNI1 repressed transcription from a *GAL4^{UAS}* containing promoter (Durrant and Dong, 2004). A SNI1-GFP fusion was shown to be localized to the nucleus (Li *et al.*, 1999), consistent with a role for SNI1 in the nucleus, presumably as a repressor of transcription. Since SNI1 does not contain a recognizable DNA binding domain it has been suggested that it represses transcription by interacting with other factors (Durrant and Dong, 2004).

Another set of genes that may be involved in SA regulated, NPR1-independent mechanism are the *WHIRLY* (*WHY*) genes, which encode putative DNA binding proteins. The potato StWhy1 protein, which binds the promoter of the *PR10a* gene, specifically binds the single stranded form of the promoter DNA (Desveaux *et al.*, 2002). In Arabidopsis, which possesses three *WHIRLY* genes, SA treatment induces the single stranded DNA binding activity of the AtWHY1 protein in both wild type and also in *npr1* mutant plants, suggesting that AtWHY1 activation is independent of NPR1 (Desveaux *et al.*, 2004). Missense mutations in the putative single stranded DNA-binding domain or the central α -helical region reduced the DNA-binding activity of AtWHY1 protein and simultaneously compromised with SA induced *PR1* gene transcript accumulation and resistance to oomycete pathogen. These results suggest that AtWHY1 is important for the SA-dependent but NPR1-independent expression of the *PR1* and resistance against pathogen.

6. THE SAR SIGNAL

Grafting and girdling experiments suggested that the development of SAR requires the movement of a signal via the phloem from the pathogen inoculated organ to the distal organs (Guedes *et al.*, 1980; Ross, 1966). However, studies in *Arabidopsis* suggest that although the phloem may be the major conduit for the SAR signal(s), some signal may move via a different route (Kiefer and Slusarenko, 2003); the pattern of SAR induction did not completely match the phloem-transport of labeled sugars out of the infected leaf. SA can be found in the phloem. Furthermore, in cucumber and tobacco, SA levels in the phloem increased during the activation of SAR (Métraux *et al.*, 1990; Rasmussen, 1991; Yalpani *et al.*, 1991). Studies with tobacco plants in which the TMV-inoculated leaves were enclosed in an $^{18}\text{O}_2$ -enriched environment provided additional evidence that SA is transported from the infected to uninfected leaves (Shulaev *et al.*, 1995). In tobacco, the conversion of benzoic acid to SA by BA2H is O_2 -dependent, thus any ^{18}O -labeled SA that appears in the distal leaves was expected to have originated in the TMV-inoculated leaf. Indeed, the radiolabel was found in approximately 70% of the SA, in uninfected leaves. Similar studies with ^{14}C -labeled benzoic acid in cucumber cotyledons infected with *Colletotrichum lagenarium* showed the appearance of ^{14}C -labeled SA in uninoculated leaves, suggesting that SA synthesized in the pathogen-inoculated leaf was transported to the uninoculated portions of the plant (Mölders *et al.*, 1996). In these experiments, it is possible that the radio-labeled SA found in the uninfected organs was derived from airborne radio-labeled MeSA released from the pathogen-infected leaves. It is equally likely that the radio-labeled SA was synthesized *de novo* in the uninfected organs from radio-labeled metabolites moving from the pathogen-infected to the uninfected leaves.

Despite SA being capable of moving from the pathogen-infected organ to the uninfected organ, grafting experiments with NahG tobacco plants have suggested that SA is not the translocated signal required for SAR (Vernooij *et al.*, 1994). When non-transgenic tobacco scions were grafted onto NahG tobacco rootstocks, following TMV infection of the rootstock, SAR was activated in the distal organs. Since the NahG rootstock, was unable to accumulate SA, the manifestation of SAR in these grafted plants indicates that SA is not the translocated signal required for the activation of SAR. Similar conclusions were derived with grafting experiments involving rootstocks from transgenic tobacco plants expressing a subunit of the cholera toxin (Beffa *et al.*, 1995). These transgenic plants accumulate very high levels of SA and exhibit enhanced resistance to pathogen. However, SAR was not constitutively activated in the wild type scions that were grafted on

the transgenic rootstock. Previous, studies in cucumber also suggested that SA may not be the phloem translocated signal in SAR; the translocated signal moved out of *P. syringae*-infected cucumber leaves before any detectable increase in SA level was observed in the phloem sap (Rasmussen *et al.*, 1991). However, although SA is not the translocated signal, it is required for the establishment of SAR in the uninfected leaves.

6.1 Involvement of lipids in systemic acquired resistance

Mutations in Arabidopsis *SFD1* (*SUPPRESSOR OF FATTY ACID DESATURASE DEFICIENCY-1*) gene compromised the activation of SAR-conferred enhanced resistance. However, basal resistance to a bacterial pathogen was unaffected in *sfd1* mutant plants, suggesting that *SFD1* is not required for basal defenses. In comparison to the wild type plant, the SAR-associated increase in SA level was compromised in *sfd1* mutants. The SAR defect of *sfd1* was restored by the application of BTH, suggesting that the block in the *sfd1* mutant is upstream of SAR-associated SA accumulation. This suggests that *SFD1* is more likely required for the synthesis and/or translocation of the mobile signal from the necrotizing pathogen-inoculated organ, or for the perception of the mobile signal or subsequent signal transduction, leading to SA accumulation in the distal organs (Nandi *et al.*, 2004). *SFD1* encodes a dihydroxyacetone phosphate (DHAP) reductase, which catalyzes the interconversion of DHAP and glycerol-3-phosphate. Glycerol-3-phosphate provides the glycerol backbone for glycerolipid synthesis. Indeed glycerolipid composition was affected in the *sfd1* mutant, especially composition of chloroplastic lipids (Nandi *et al.*, 2003, 2004). SAR is compromised and chloroplastic glycerolipid composition altered in the Arabidopsis *sfd2* and *fad7* mutants (K. Krothapalli, A. Nandi, R. Chaturvedi and J. Shah, unpublished), providing further support to the participation of a glycerolipid-derived molecule in SAR. Studies of the Arabidopsis *defective in induced resistance1* (*dir1*) mutant provided additional support for the involvement of a lipid-derived factor in the activation of SAR (Maldonado *et al.*, 2002; Suzuki *et al.*, 2004). *DIR1* is a putative lipid transfer protein. *DIR1* localizes to the phloem. Phloem localization of *DIR1* is activated during SAR. Furthermore, like the *sfd1* mutant, SAR is compromised in the *dir1* mutant (Maldonado *et al.*, 2002; Suzuki *et al.*, 2004). Unlike petiole exudate, which is enriched in phloem sap, collected from avirulent pathogen-inoculated wild type leaves, similar exudates collected from petioles of leaves from the *dir1* mutant were unable to activate *PR1* expression when applied to the leaves of wild type plant (Maldonado *et al.*, 2002). These results suggest that *DIR1* may be involved

in the synthesis or transport of a lipid-derived factor to the distal tissues for the establishment of SAR.

The SALICYLIC ACID-BINDING PROTEIN 2 (SABP2) of tobacco, which has lipase/esterase activity, is required for the SAR-conferred resistance to TMV (Kumar and Klessig, 2003). MeSA is one of the substrates for SABP2 (Forouhar *et al.*, 2005). Similarly, the *EDS1* and *PAD4* genes, which encode proteins that have homology to acyl hydrolases, are also required for the activation of SAR (Wiermer *et al.*, 2005). In addition, to their involvement in SAR, *SABP2*, *EDS1* and *PAD4* are also required for local defenses, suggesting that lipids may affect SA-mediated plant defenses at multiple stages.

7. CROSS TALK BETWEEN SALICYLIC ACID SIGNALING AND OTHER DEFENSE SIGNALING MECHANISMS

In addition to SAR, *NPR1* is also required for Induced Systemic Resistance (ISR), which is activated by root colonizing rhizobacteria (Pieterse *et al.*, 2001; Pieterse and Van Loon, 2004). ISR confers enhanced resistance in foliar tissues against a variety of pathogens. In Arabidopsis, ISR and SAR have a combinatorial effect on controlling growth of *P. syringae*. Unlike SAR, SA is not required for the activation of ISR, which requires ethylene and JA signaling. *NPR1* function in the nucleus is required for the activation of SAR. However, in case of ISR, *NPR1* is required in the cytosol (Spoel *et al.*, 2003). These results suggest that *NPR1* may be a key component regulating cross talk between SA regulated SAR and ethylene/JA regulated ISR. Several studies have suggested that SA and JA signaling antagonize each other. For example, when co-applied to leaves, the presence of SA represses expression of JA-induced genes. In contrast, in comparison to the wild type plant, preventing SA accumulation during pathogen infection due to expression of the *nahG* resulting in the enhanced expression of several JA induced genes (Spoel *et al.*, 2003). Furthermore, the antagonistic effect of SA on JA signaling was overcome in the *npr1* mutant background, suggesting that SA signaling through *NPR1* is required for repressing JA signaling (Spoel *et al.*, 2003). Previously, in tomato SA was also shown to inhibit the activity of enzymes involved in JA synthesis (Doares *et al.*, 1995; Doherty *et al.*, 1988), suggesting that the antagonistic effect of SA is exerted at the level of JA synthesis and signaling.

Recently, the Arabidopsis WRKY70 gene encoded transcription factor was shown to be involved in modulating this cross talk between SA and JA signaling (Li *et al.*, 2004). While WRKY70 functions as a positive regulator of SA signaling, it also functions as a repressor of JA signaling. Antisense-suppression of *WRKY70* expression compromised the expression of *PR* genes but simultaneously allowed constitutive expression of JA-inducible genes in Arabidopsis. The overexpression of *WRKY70* conferred constitutive, SA- and NPR1-independent expression of *PR* genes. In contrast, the JA-activated expression of *PDF1.2* was compromised in these *WRKY70*-overexpressing Arabidopsis plants. Whether NPR1 and WRKY70 function in concert in repressing JA signaling and promoting SA signaling is not known. Genetic studies with Arabidopsis *eds4* and *pad4* mutants, that are impaired in SA accumulation, and the *cpr6* mutant, which accumulates elevated SA level and constitutively expresses SA dependent defense responses, provided additional evidence for an antagonistic effect of SA on JA signaling (Clarke *et al.*, 2000; Gupta *et al.*, 2000). Expression of JA-inducible genes was hyperactivated in the *eds4* and *pad4* mutants. Furthermore, in contrast to the *cpr6* mutant, blocking *cpr6*-conferred accumulation of high SA level in the *cpr6 eds5* double mutant plants resulted in higher level of expression of JA-modulated genes (Clarke *et al.*, 2000). However, in another study it was suggested that the EDS5 and PAD4 proteins could affect JA signaling independently of their involvement with SA signaling (Nandi *et al.*, 2005). SA signaling is also known to antagonize plant defense against insects. For example, TMV infection, and SA and BTH application increased the vulnerability of plants to some insect herbivores (Stout *et al.*, 1998, 1999; Preston *et al.*, 1999; Thaler *et al.*, 1999). In contrast, a heightened level of resistance to feeding by larvae of the tobacco hornworm, *Manduca sexta* was observed in PAL silenced tobacco and NahG tobacco plants (Felton and Korth, 2000).

Growing evidences also point to an antagonistic effect of JA on SA signaling. In tobacco, studies with elicitors produced by *Erwinia carotovora* have revealed that JA inhibits the expression of SA-dependent genes (Vidal *et al.*, 1997; Niki *et al.*, 1998; Norman-Setterblad *et al.*, 2000). Several studies in Arabidopsis have also suggested that JA antagonizes SA signaling. For example, a loss-of-function mutation in the Arabidopsis *MPK4* gene, which encodes a mitogen-activated kinase, impaired JA signaling and simultaneously conferred enhanced resistance against bacterial and oomycete pathogens as a result of constitutive activation of SA signaling (Petersen *et al.*, 2000). However, expression of JA-mediated responses was also observed in the *mpk4 nahG* plant, suggesting that the impairment of JA signaling in the *mpk4* mutants is not due to an inhibitory effect of elevated levels of SA. Similarly, JA signaling is repressed in the Arabidopsis *ssi2*

mutant, in which SA signaling is constitutively active (Kachroo *et al.*, 2001; Shah *et al.*, 2001). The *ssi2* mutant is not impaired in its ability to accumulate JA (Kachroo *et al.*, 2003). Furthermore, the *ssi2*-conferred repression of JA signaling was retained in the SA-deficient *ssi2 nahG* plants, suggesting that the *ssi2*-conferred repression is exerted at the level of JA signaling and not JA accumulation. In addition, the above observations also suggest that the *ssi2*-conferred impairment of JA signaling is not due to the constitutive activation of SA signaling in the *ssi2* mutant (Kachroo *et al.*, 2001). Kunkel and Brooks (2002) have suggested that the constitutive SA signaling in the *mpk4* and *ssi2* mutants is likely due to loss of an antagonistic effect of JA signaling on the SA pathway. Some pathogens have evolved to co-opt the plant hosts JA signaling pathway to repress SA signaling, thereby allowing pathogen growth. Coronatine, which is produced by some *P. syringae* pathovars, mimics JA. Activation of JA signaling by coronatine results in the repression of SA signaling. This explains why mutations like *coil*, which compromise JA signaling, confer enhanced resistance to *P. syringae* (Kunkel and Brooks, 2002). Indeed, the enhanced resistance of the *coil* mutant correlated with the faster activation of SA-induced defense genes in the mutant plant (Kloek *et al.*, 2001). Furthermore, SA was required for the *coil*-conferred enhanced resistance.

Despite the strong evidence of mutual antagonism between SA and JA signaling pathways, SA and JA are also known to function synergistically in plant defense. For example, the co-application of SA and JA was found to synergistically activate *PR1b* expression in tobacco (Xu *et al.*, 1994). In addition, significant overlap exists in the expression pattern of genes induced by SA and JA; the same genes being induced by both SA and JA (Schenk *et al.*, 2000). Microarray studies have shown that in addition to the SA mediated genes, expression of a large set of JA and ethylene inducible genes was also affected in the Arabidopsis *npr1-1* mutant (Glazebrook *et al.*, 2003). JA/ethylene and SA also have an additive effect in the rhizobacteria-induced resistance of Arabidopsis to the bacterial pathogen *P. syringae* pv *tomato* (Van Wees *et al.*, 2000). Rhizobacteria mediated protection, which is dependent on JA-/ET-signaling, was greater in the *cpr1* mutant, in which SA signaling is hyperactive, than the wild type plant. In tomato seedlings, the simultaneous application of BTH and ISR-inducing PGPR resulted in the reduced incidence of bacterial wilt caused by *Ralstonia solanacearum* (Anith *et al.*, 2004). In the Arabidopsis *ssi1*, *cpr5*, *cpr6* and *hrl1* mutants, SA and JA-regulated defenses are constitutively expressed (Shah *et al.*, 1999; Clarke *et al.*, 2000; Devadas *et al.*, 2002). Furthermore, ethylene and JA signaling were required for *crp5* and *crp6*-conferred resistance to bacterial and oomycete pathogens (Clarke *et al.*, 2000), and ethylene

signaling was also required for the enhanced resistance conferred by *hrl1* (Devadas *et al.*, 2002).

8. TARGETING SALICYLIC ACID SIGNALING FOR ENHANCING PLANT RESISTANCE AGAINST PATHOGEN

Besides Arabidopsis and tobacco, SA and its functional analogs, INA and BTH, also induce defense responses in agronomically important plants. For example, BTH protects rice from the blast fungus *M. grisea* and maize from downy mildew (Gorlach *et al.*, 1996; Morris *et al.*, 1998), while INA activates defense gene expression as well as resistance to powdery mildew in barley (Kogel *et al.*, 1994; Wasternack *et al.*, 1994). Likewise, these two chemicals also protect wheat from leaf rust caused by *Puccinia recondita*, septorial leaf spot, and powdery mildew caused by *Erysiphe graminis* f sp. *tritici* (Gorlach *et al.*, 1996). In rice SA is required for limiting the growth of the rice blast pathogen (Yang *et al.*, 2004). Homologues of NPR1 have been identified in rice, tobacco, tomato, apple, wheat and orange (Chern *et al.*, 2001; Durrant and Dong, 2004; Makandar and Shah, unpublished), suggesting conservation of SA mediated defense signaling between dicots and monocots.

Attempts have been made to target induced resistance mechanisms for enhancing disease resistance in plants (Kogel and Langen, 2005). Previously, overexpression of the *NPR1* gene was shown to confer enhanced resistance in Arabidopsis (Cao *et al.*, 1998; Friedrich *et al.*, 2001) under controlled conditions. In rice constitutive expression of the Arabidopsis *NPR1* gene conferred enhanced resistance to bacterial blight, caused by *Xanthomonas oryzae* (Chern *et al.*, 2001), while in tomato, overexpression of Arabidopsis *NPR1* conferred enhanced resistance against bacterial and fungal pathogens (Lin *et al.*, 2004). Similarly in wheat, constitutive expression of Arabidopsis *NPR1* under green house conditions conferred enhanced resistance against scab disease caused by *Fusarium graminearum* (Makandar *et al.*, 2006). In Arabidopsis, rice and wheat it was shown that constitutive expression of Arabidopsis *NPR1* confers faster and stronger activation of SA-mediated defense responses. Thus the SA signaling pathway is amenable for engineering disease resistance in plants.

8.1 Fitness costs associated with the activation of salicylic acid signaling

Although, under conditions of high pathogen pressure, the ability to induce SAR is expected to have a positive effect on plant fitness, constitutive expression of SA signaling may carry a fitness cost due to the allocation of resources and energy away from growth and reproduction to the expression of defense responses (Heil and Baldwin, 2002; Heil, 2002). For example, SA treatment decreased seed yield in *Arabidopsis* (Cipollini, 2002). Furthermore, several *Arabidopsis* mutants in which SA signaling is constitutively active exhibit reduced plant size, loss of apical dominance, curly leaves and decreased fertility (Heil and Bostock, 2002). In wheat, a study carried out to observe the effect of BTH application on plant fitness in the absence of pathogen pressure, showed reduction in biomass and number of ears and grain (Heil *et al.*, 2000). These adverse effects of BTH treatment on plant fitness were more severe under conditions of N-limitation. Similarly, N-limitation was shown to adversely affect the induction of SA mediated responses in *Nicotiana attenuata* (Lou and Baldwin, 2004). In rice, overexpression of either the *Arabidopsis NPR1* or the rice *NPR1* gene was associated with the spontaneous development of chlorotic lesions containing dead cells and the accumulation of hydrogen peroxide under certain growth conditions (Fitzgerald *et al.*, 2004; Chern *et al.*, 2005). Furthermore, these detrimental phenotypes were more pronounced when the plants were treated with BTH (Fitzgerald *et al.*, 2004; Chern *et al.*, 2005), further suggesting the cost association with the inappropriate activation of plant defenses. Hence, future efforts to target plant defense mechanisms will have to consider this fine line between cost and benefit and will have to circumvent the negative impacts associated with the activation of defense responses.

9. CONCLUSIONS

Our understanding of the role of SA in plant defense against pathogens has increased considerably over the recent years. SA biosynthesis mechanisms have been elucidated. Furthermore, genetic studies in *Arabidopsis thaliana* have greatly contributed towards understanding the signaling mechanisms underlying the involvement of SA in plant defense. The *NPR1* gene, which is conserved amongst plants, is a key regulator of SA signaling. There is evidence for negative and positive feedback regulation of SA synthesis, signaling and cross-talk between SA and other defense signaling pathways. Important challenges for the future, include

identification of the mobile signal for SAR. Recent studies suggest that a lipid-derived molecule may have a role in the translocation of SAR signal. SAR provides an excellent target for controlling losses due to plant diseases. NPR1 overexpression has been successfully demonstrated to enhance disease resistance in tomato, wheat and rice, conferring resistance against a variety of pathogens. The ability to target this pathway offers promise in reducing our dependence on toxic chemicals to protect plants without endangering our environment and health.

10. ACKNOWLEDGEMENTS

Work in Shah's laboratory was supported by the funds received from National Science Foundation, United States Department of Agriculture, and US Wheat and Barley Scab Initiative.

11. REFERENCES

- Allan, A. C., and Fluhr, R., 1997. Two distinct sources of elicited reactive oxygen species in tobacco epidermal cells. *Plant Cell*, **9**: 1559-1572.
- Anderson, M. D., Chen, Z., and Klessig, D. F., 1998. Possible involvement of lipid peroxidation in salicylic acid-mediated induction of *PR1* gene expression. *Phytochem.*, **47**: 555-566.
- Anith, K. N., Momol, M. T., Kloepper, J. W., Marois, J. J., Olson, S. M., and Jones, J. B. 2004. Efficacy of plant growth-promoting rhizobacteria, acibenzolar-S-methyl, and soil amendment for integrated management of bacterial wilt on tomato. *Plant Dis.*, **88**: 669-673.
- Antoniw, J. F., and White, R. F., 1980. The effects of aspirin and polyacrylic acid on soluble leaf proteins and resistance to virus infection in five cultivars of tobacco. *Phytopathol. Z.*, **98**: 331-341.
- Beffa, R., Szell, M., Meuwly, P., Pay, A., Vögeli-Lange, R., Métraux, J.-P., Neuhaus, G., Meins, F. Jr., and Nagy, F., 1995. Cholera toxin elevates pathogen resistance and induces pathogenesis-related gene expression in tobacco. *EMBO J.*, **14**: 5753-5761.
- Belkhadir, Y., Subramaniam, R., and Dangl, J. L., 2004. Plant disease resistance protein signaling: NBS-LRR proteins and their partners. *Curr. Opin Plant Biol.*, **7**: 391-399.
- Belfanti, E., Silfverberg-Dilworth, E., Tartarini, S., Patocchi, A., Barbieri, M., Zhu, J., Vinatzer, B. A., Gianfranceschi, L., Gessler, C., and Sansavini, S., 2004. The *HcrVf2* gene from a wild apple confers scab resistance to a transgenic cultivated variety. *Proc. Natl. Acad. Sci. USA.*, **101**: 886-890.
- Bi, Y. M., Kenton, P., Mur, L., Darby, R., and Draper, J., 1995. Hydrogen peroxide does not function downstream of salicylic acid in the induction of PR protein expression. *Plant J.*, **8**: 235-245.

- Bowling, S. A., Guo, A., Cao, H., Gordon, A. S., Klessig, D. F., and Dong, X., 1994. A mutation in *Arabidopsis* that leads to constitutive expression of systemic acquired resistance. *Plant Cell*, **6**: 1845-1857.
- Bowling, S. A., Clarke, J. D., Liu, Y., Klessig, D. F., and Dong, X., 1997. The *cpr5* mutant of *Arabidopsis* expresses both NPR1-dependent and NPR1-independent resistance. *Plant Cell*, **9**: 1573-1584.
- Bostock, R. M., 2005. Crosstalk and induced resistance: Straddling the line between cost and benefit. *Annu. Rev. Phytopath.*, **43**: 545-580.
- Brodersen, P., Petersen, M., Pike, M. H., Olszak, B., Skov, S., Odum, N., Jorgensen, L. B., Brown, R. E., and Mundy, J., 2002. Knockout of *Arabidopsis ACCELERATED-CELL DEATH11* encoding a sphingosine transfer protein causes activation of programmed cell death and defense. *Genes Dev.*, **16**: 490-502.
- Cao, H., Bowling, S. A., Gordon, A. S., and Dong, X., 1994. Characterization of an *Arabidopsis* mutant that is nonresponsive to inducers of systemic acquired resistance. *Plant Cell*, **6**: 1583-1592.
- Cao, H., Glazebrook, J., Clark, J. D., Volko, S., and Dong, X., 1997. The *Arabidopsis NPR1* gene that controls systemic acquired resistance encodes a novel protein containing ankyrin repeats. *Cell*, **88**: 57-63.
- Cao, H., Li, X., and Dong, X., 1998. Generation of broad-spectrum disease resistance by overexpression of an essential regulatory gene in systemic acquired resistance. *Proc. Natl. Acad. Sci. USA.*, **95**: 6531-6536.
- Chamngpol, S., Willekens H., Moeder, W., Langebartels, C., Sandermann, H. Jr., Van Montagu M., Inze, D., and Van Camp, W., 1998. Defense activation and enhanced pathogen tolerance induced by H₂O₂ in transgenic tobacco. *Proc. Natl. Acad. Sci. USA.*, **95**: 588-1823.
- Chandra-Shekara A. C., Navarre, D., Kachroo, A., Kang, H. G., Klessig, D., and Kachroo, P., 2004. Signaling requirements and role of salicylic acid in *HRT*- and *rrt*-mediated resistance to turnip crinkle virus in *Arabidopsis*. *Plant J.*, **40**: 647-659.
- Chen, F., D'Auria, J. C., Tholl, D., Ross, J. R., Gerzhenzon, J., Noel, J. P., and Pichersky, E., 2003. An *Arabidopsis thaliana* gene for methylsalicylate biosynthesis, identified by a biochemical genomics approach, has a role in defense. *Plant J.*, **36**: 577-588.
- Chen, Z., Iyer, S., Caplan, A., Klessig, D. F., and Fan, B., 1997. Differential accumulation of salicylic acid and salicylic acid sensitive catalase in different rice tissue. *Plant Physiol.*, **114**: 193-201.
- Chen, Z., Silva, H., and Klessig, D. F., 1993. Active oxygen species in the induction of plant systemic acquired resistance by salicylic acid. *Science*, **262**: 1883-1886.
- Chern, M. S., Fitzgerald, H. A., Yadav, R. C., Canlas, P.E., Dong, X. N., and Ronald, P. C., 2001. Evidence for a disease-resistance pathway in rice similar to the NPR1-mediated signaling pathway in *Arabidopsis*. *Plant J.*, **27**: 101-113.
- Chern, M. S., Fitzgerald, H. A., Yadav, R. C., Canlas, P. E., Navarre, D. A., and Ronald, P. C., 2005. Overexpression of a rice NPR1 homolog leads to constitutive activation of defense response and hypersensitivity to light. *Mol. Plant-Micro. Int.*, **18**: 511-520.
- Cipollini, D.F., 2002. Does competition magnify the fitness costs of induced responses in *Arabidopsis thaliana*? A manipulative approach. *Oecologia*, **131**: 514-520.
- Clarke, J. D., Volko, S. M., Ledford, H., Ausubel, F. M., and Dong, X., 2000. Roles of salicylic acid, jasmonic acid, and ethylene in *cpr*-induced resistance in *Arabidopsis*. *Plant Cell*, **12**: 2175-2190.

- Coquoz, J. L., Buchala, A., and Métraux, P., 1995. Arachidonic acid induces local but not systemic synthesis of salicylic acid and confers systemic resistance in potato plants to *Phytophthora infestans* and *Alternaria solani*. *Phytopath.*, **85**: 1219–1224
- Chong, J. Marie-Agnès Pierrel, M.A., Atanassova, R., Reichhart, D.W., Fritig, B., and Saindrenan, P., 2001. Free and conjugated benzoic acid in tobacco plants and cell cultures. Induced accumulation upon elicitation of defense responses and role as salicylic acid precursors. *Plant Physiol.*, **125**: 318–328.
- Dangl, J. L., and Jones, J. D. G., 2001. Plant pathogens and integrated defense responses to infection. *Nature*, **411**: 826-833.
- Delaney, T.P., Uknes, S., Vernooij, B., Friedrich, L., Weymann, K., Negrotto, D., Gaffney, T., Gut-Rella, M., Kessmann, H., Ward, E., and Ryals, J., 1994. A central role of salicylic acid in plant disease resistance. *Science*, **266**: 1247–1250.
- Delaney, T.P., Friedrich, L., and Ryals, J.A., 1995. *Arabidopsis* signal transduction mutant defective in chemically and biologically induced disease resistance. *Proc. Natl. Acad. Sci. USA.*, **92**: 6602-6606.
- Dempsey, D.A., Shah, J., and Klessig, D. F., 1999. Salicylic acid and disease resistance in plants. *Crit. Rev. Plant Sci.*, **18**: 547-575.
- Després, C., Chubak, C., Rochon, A., Clark, R., Bethune, T., Desveaux, D., and Fobert, P. R., 2003. The *Arabidopsis* NPR1 disease resistance protein is a novel cofactor that confers redox regulation of DNA binding activity to the basic domain/leucine zipper transcription factor TGA1. *Plant Cell*, **15**: 2181–2191.
- Després, C., De Long, C., Glaze, S., Liu, E., and Fobert, P.R., 2000. The Arabidopsis NPR1/NIM1 protein enhances the DNA binding activity of a subgroup of the *TGA* family of *bZIP* transcription factors. *Plant Cell*, **12**: 279-290.
- Devadas, S. K., Enyedi, A., and Raina, R., 2002. The *Arabidopsis hrl1* mutation reveals novel overlapping roles for salicylic acid, jasmonic acid and ethylene signaling in cell death and defence against pathogens. *Plant J.*, **30**: 467–80.
- Desveaux, D., Allard, J., Brisson, N., and Sygusch, J., 2002. A new family of plant transcription factors displays a novel ssDNA-binding surface. *Nat. Str. Biol.*, **9**: 512-517.
- Desveaux, D., Subramaniam, R., Després, C., Mess, J. N., Lévesque, C. L., Fobert, P. R., Dangl, J. L., and Brisson, N., 2004. A “Whirly” Transcription Factor Is Required for Salicylic Acid-Dependent Disease Resistance in *Arabidopsis*. *Dev. Cell*, **6**: 229–240.
- Devoto, A., and Turner, J. G., 2003. Regulation of jasmonate-mediated plant responses in *Arabidopsis*. *Ann. Bot.*, **92**: 329–337.
- Doares, S. H., Narvaez-Vasquez, J., Conconi, A., and Ryan, C., 1995. Salicylic acid inhibits synthesis of proteinase inhibitors in tomato leaves induced by systemin and jasmonic acid. *Plant Physiol.*, **108**: 1741–1746.
- Doherty, H., Selvendran, R., and Bowles, D., 1988. The wound response of tomato plants can be inhibited by aspirin and related hydroxy-benzoic acids. *Physiol. Mol. Plant Pathol.*, **33**: 377–384.
- Dong, X. N., 2004. NPR1, all things considered. *Curr. Opin. Plant Biol.*, **7**:547–552
- Du, H., and Klessig, D. F. 1997. Identification of a soluble, high-affinity salicylic acid binding protein in tobacco. *Plant Physiol.*, **113**: 1319–1327.
- Durner, J., and Klessig, D. F., 1995. Inhibition of ascorbate peroxidase by salicylic acid and 2, 6-dichloroisonicotinic acid, two inducers of plant defense responses. *Proc. Natl. Acad. Sci. USA.*, **92**: 11312–11316.
- Durrant, W. E., and Dong, X., 2004. Systemic acquired resistance. *Annu. Rev. Phytopath.*, **42**: 185–209.

- Enyedi, A. J., and Raskin, I., 1993. Induction of UDP-glucose salicylic acid and glucosyltransferase activity in tobacco mosaic virus-inoculated tobacco *Nicotiana tabacum* leaves. *Plant Physiol.*, **101**: 1375-1380.
- Falk, A., Feys, B. J., Frost, L. N., Jones, J. D.G., Daniels, M. J., and Parker, J. E., 1999. EDS1, an essential component of *R* gene-mediated disease resistance in *Arabidopsis* has homology to eukaryotic lipases. *Proc. Natl. Acad. Sci. USA.*, **96**: 3292-3297.
- Felton, G. W., and Korth, K. L., 2000. Trade-offs between pathogen and herbivore resistance. *Curr. Opin. Plant Biol.*, **3**: 309-314.
- Feys, B.J., Wiermer, M., Bhat, A., R., Lisa J. Moisan, J. M., Escobar, M. N., Neu, C., Cabral, A., and Parker, J. E., 2005. Arabidopsis SENESCENCE-ASSOCIATED GENE101 stabilizes and signals within an ENHANCED DISEASE SUSCEPTIBILITY1 complex in plant innate immunity. *Plant Cell.*, **17**: 2601-2613.
- Feys, B. J., Moisan, L. J., Newman, M. A., and Parker, J. E., 2001. Direct interaction between the *Arabidopsis* disease resistance signaling proteins, EDS1 and PAD4. *EMBO J.*, **20**: 5400-5411.
- Fitzgerald, H. A., Chern, M. S., Navarre, R., and Ronald. P. C., 2004. Overexpression of (*At*)*NPR1* in rice leads to a BTH-and environment-induced lesion-mimic/cell death phenotype. *Mol. Plant-Microbe Inter.*, **17**: 140-151.
- Forouhar, F., Yang, Y., Kumar, D., Chen, Y., Fridman, E., Park, W.S., Chiang, Y., Acton, B. T., Montelione T.G., Pichersky, E., Klessig, D.F., and Tong, L., 2005. Structural and biochemical studies identify tobacco SABP2 as a methyl salicylate esterase and implicate it in plant innate immunity. *Proc. Natl. Acad. Sci. USA.*, **102**: 1773-1778.
- Friedrich, L., Lawton, K., Dietrich, R., Willits, M., Cade, R., and Ryals, J., 2001. *NIMI* overexpression in Arabidopsis potentiates plant disease resistance and results in enhanced effectiveness of fungicides. *Mol. Plant Microbe Inter.*, **14**: 1114-1124.
- Friedrich, L., Lawton, K., Reuss, W., Masner, P., Specker, N., Friedrich, L. N., Lawton, K., Ruess, W., Masner, P., Specker, N., Gut-Rella, M., Meier, B., Dincher, S., Staub, T., Uknes, S., Métraux, J. P., Kessmann, H., and Ryals, J., 1996. A benzothiadiazole induces systemic acquired resistance in tobacco. *Plant J.*, **10**: 61-70.
- Gaffney, T., Friedrich, L., Vernooij, B., Negrotto, D., Nye, G., Uknes, S., Ward, E., Kessmann, H., and Ryals, J., 1993. Requirement of salicylic acid for the induction of systemic acquired resistance. *Science*, **261**: 754-756.
- Genoud, T., Buchala, A.J., Chua, N.-H., and Métraux, J.-P., 2002. Phytochrome signalling modulates the SA-perceptive pathway in Arabidopsis. *Plant J.*, **31**: 87-95.
- Gilbert, R. D., Johnson, A. N., and Dean, R. A., 1996. Chemical signals responsible for appressorium formation in the rice blast fungus *Magnaporthe grisea*. *Physiol. Mol. Plant Pathol.*, **48**: 335-346.
- Glazebrook, J., Chen, W. J., Estes, B., Chang, H. S., Nawrath, C., Métraux, J. P., Zhuand, T., and Katagiri, F., 2003. Topology of the network integrating salicylate and jasmonate signal transduction derived from global expression phenotyping. *Plant J.*, **34**: 217-228.
- Glazebrook, J., Rogers, E. E., and Ausubel, F. M., 1996. Isolation of Arabidopsis mutants with enhanced disease susceptibility by direct screening. *Genetics*, **143**: 973-982.
- Gomez-Gomez, L., and Boller, T., 2002. Flagellin perception: a paradigm for innate immunity. *Tren. Plant. Sci.*, **6**: 251-256.
- Gorlach, J., Volrath, S., Knauf-Beiter, G., Hengy, G., Beckhove, U., Kogel, K.-H., Oostendorp, M., Staub, T., Ward, E., Kessmann, H., and Ryals, J., 1996. Benzothiadiazole, a novel class of inducers of systemic acquired resistance, activates gene expression and disease resistance in wheat. *Plant Cell*, **8**: 629-643.

- Guedes, M.E.M., Richmond, S., and Kuc, J., 1980. Induced systemic resistance to anthracnose in cucumber as influenced by the location of the inducer inoculation with *Colletotrichum lagenarium* and the onset of flowering and fruiting. *Physiol. Plant Pathol.*, **17**: 229–233.
- Gupta, V., Willits, M.G., and Glazebrook, J., 2000. *Arabidopsis thaliana EDS4* contributes to salicylic acid (SA)-dependent expression of defense responses: evidence for inhibition of jasmonic acid signaling by SA. *Mol. Plant Microbe Inter.*, **13**: 503–511.
- Heil, M., 2002. Ecological costs of induced resistance. *Curr. Opin. Plant Biol.*, **5**: 345–350.
- Heil, M., and Baldwin, I. T., 2002. Fitness costs of induced resistance: emerging experimental support for a slippery concept. *Tren. Plant Sci.*, **7**: 61–67.
- Heil, M., and Bostock, R. M. 2002. Induced systemic resistance (ISR) against pathogens in the context of induced plant defences. *Ann. Bot.*, **89**: 503–512.
- Heil, M., Hilpert, A., Kaiser, W., and Linsenmair, K. E., 2000. Reduced growth and seed set following chemical induction of pathogen defence: does systemic acquired resistance (SAR) incur allocation costs? *J. Ecol.*, **88**: 645–654.
- Hennig, J., Malamy, J., Gryniewicz, G., Indulski, J., and Klessig, D. F. 1993. Interconversion of the salicylic acid signal and its glucoside in tobacco. *Plant J.*, **4**: 593–600.
- Hua, J., Grisafi, P., Cheng, S. H., and Fink, G. R., 2001. Plant growth homeostasis is controlled by the *Arabidopsis BON1* and *BAP1* genes. *Genes Dev.*, **15**: 2263–2272.
- Johnson, C., Boden, E., and Arias, J., 2003. Salicylic acid and NPR1 induce the recruitment of *trans*-activating TGA factors to a defense gene promoter in *Arabidopsis*. *Plant Cell*, **15**: 1846–1858.
- Jones, J. D., 2001. Putting knowledge of plant disease resistance genes to work. *Curr. Opin. Plant. Biol.*, **4**: 281–287.
- Kachroo, P., Kachroo, A., Lapchyk, L., Hildebrand, D., and Klessig, D. F., 2003. Restoration of defective cross talk in *ssi2* mutants: role of salicylic acid, jasmonic acid, and fatty acids in SSI2-mediated signaling. *Mol. Plant-Microbe. Inter.*, **16**: 1022–1029.
- Kachroo, P., Shanklin, J., Shah, J., Whittle, E. J., and Klessig, D.F., 2001. A fatty acid desaturase modulates the activation of defense signaling pathways in plants. *Proc. Natl. Acad. Sci. USA.*, **98**: 9448–9453.
- Kiefer, I. W., and Slusarenko, A.J., 2003. The pattern of systemic acquired resistance induction within the *Arabidopsis* rosette in relation to the pattern of translocation. *Plant Physiol.*, **132**: 840–847.
- Kinkema, M., Fan, W., and Dong, X., 2000. Nuclear localization of NPR1 is required for activation of *PR* gene expression. *Plant Cell*, **12**: 2339–2350.
- Kloek, A. P., Verbsky, M. L., Sharma, S. B., Schoelz, J. E., Vogel, J., Klessig, D. F., and Kunkel, B.N., 2001. Resistance to *Pseudomonas syringae* conferred by an *Arabidopsis thaliana coronatine-insensitive (coi1)* mutation occurs through two distinct mechanisms. *Plant J.*, **26**: 509–522.
- Kogel, K.-H., Beckhove, U., Dreschers, J., Münch, S., and Rommé, Y., 1994. Acquired resistance in barley. *Plant Physiol.*, **106**: 1269–1277.
- Kogel, K.-H., and Langen, G., 2005. Induced disease resistance and gene expression in cereals. *Cell. Microbiol.*, **7**: 1555–1564.
- Kohler, A., Schwindling, S., and Conrath U., 2002. Benzothiadiazole-induced priming for potentiated responses to pathogen infection, wounding, and infiltration of water into leaves require the *NPR1/NIM1* gene in *Arabidopsis*. *Plant Physiol.*, **128**: 1046–1056.

- Kumar, D., and Klessig, D.F., 2003. High-affinity salicylic acid-binding protein 2 is required for plant innate immunity and has salicylic acid-stimulated lipase activity. *Proc. Natl. Acad. Sci. USA*, **100**: 16101-16106.
- Kunkel, B. N., and Brooks, D. M., 2002. Cross talk between signaling pathways in pathogen defense. *Curr. Opin. Plant Biol.*, **5**: 325-331.
- Kus, J.V., Zaton, K., Sarkar, R., and Cameron, R.K., 2002. Age-related resistance in *Arabidopsis* is a developmentally regulated defense response to *Pseudomonas syringae*. *Plant Cell*, **14**: 479-490.
- Lam, E., 2004. Controlled cell death, plant survival and development. *Nature Rev. Mol. Cell Biol.*, **5**: 305-315.
- Lam, E., Kato, N., and Lawton, M., 2001. Programmed cell death, mitochondria and the plant hypersensitive response. *Nature*, **411**: 848-853.
- Lawton, K.A., Friedrich, L., Hunt, M., Weymann, K., Delaney, T., Kessmann, H., Staub, T., and Ryals, J., 1996. Benzothiadiazole induces disease resistance in *Arabidopsis* by activation of the systemic acquired resistance signal transduction pathway. *Plant J.*, **10**: 71-82.
- Léon, J., Lawton, M.A., and Raskin, I., 1995a. Hydrogen peroxide stimulates salicylic acid biosynthesis in tobacco. *Plant Physiol.*, **108**: 1673-1678.
- Léon, J., Shulaev, V., Yalpani, N., Lawton, M. A., and Raskin, I., 1995b. Benzoic acid 2-hydroxylase, a soluble oxygenase from tobacco, catalyzes salicylic acid biosynthesis. *Proc. Natl. Acad. Sci. USA*, **92**: 10413-10417.
- Lebel, E., Heifetz, P., Thorne, L., Uknes, S., Ryals, J., and Ward, E., 1998. Functional analysis of regulatory sequences controlling PR-1 gene expression in *Arabidopsis*. *Plant J.*, **16**: 223-233.
- Lee, H. I., Leon, J., and Raskin, I., 1995. Biosynthesis and metabolism of salicylic acid. *Proc. Natl. Acad. Sci. USA*, **92**: 4076-4079.
- Li, J., Brader, G., and Palva, E. T., 2004. The WRKY70 transcription factor: a node of convergence for jasmonate-mediated and salicylate-mediated signals in plant defense. *Plant Cell*, **16**: 319-331.
- Li, X., Zhang, Y., Clarke, J.D., Li, Y., and Dong, X., 1999. Identification and cloning of a negative regulator of systemic acquired resistance, SN11, through a screen for suppressors of *npr1-1*. *Cell*, **98**: 329-339.
- Lin, W.C., Lu, C. F., Wu, J. W., Cheng, M. L., Lin, Y. M., Yang, N. S., Black, L., Green, S. K., Wang, J. F., and Cheng, C.P., 2004. Transgenic tomato plants expressing the *Arabidopsis NPR1* gene display enhanced resistance to a spectrum of fungal and bacterial diseases. *Transgenic Res.*, **13**: 567-581.
- Lou, Y. G., and Baldwin, I. T., 2004. Nitrogen supply influences herbivore-induced direct and indirect defenses and transcriptional responses to *Nicotiana attenuata*. *Plant Physiol.*, **135**: 496-506.
- Makandar, R., Essig, J. S., Schapaugh, M. A., Trick, H. N., and Shah, J., 2006. Genetically engineered resistance to *Fusarium* head blight in wheat by expression of *Arabidopsis* NPR1. *Mol. Plant-Microbe Inter.*, **19**: 123-129.
- Malamy, J., Carr, J.P. and Klessig, D.F., and Raskin, I., 1990. Salicylic acid: a likely endogenous signal in the resistance response of tobacco to viral infection. *Science*, **250**: 1002-1004.
- Malamy, J., and Klessig, D. F., 1992. Salicylic acid and plant disease resistance. *Plant J.*, **2**: 643-654.

- Maldonado, A.M., Doerner, P., Dixon, R. A., Lamb, C. J., and Cameron, R. K., 2002. A putative lipid transfer protein involved in systemic resistance signaling in *Arabidopsis*. *Nature*, **419**: 399–403.
- Mateo, A., Mühlenbock, P., Rustérucchi, C., Chi-Chen Chang, C., Miszalski, Z., Karpinska, B., Parker, J. E., Mullineaux, P. M., and Karpinski, S., 2004. *LESION SIMULATING DISEASE 1* is required for acclimation to conditions that promote excess excitation energy. *Plant Physiol.*, **136**: 2818–2830.
- Mauch-Mani, B., and Slusarenko, A.J., 1996. Production of salicylic acid precursors is a major function of phenylalanine ammonia-lyase in the resistance of *Arabidopsis* to *Peronospora parasitica*. *Plant Cell*, **8**: 203–212.
- Mauch, F., Mauch-Mani, B., Gaille, C., Kull, B., Haas, D., and Reimmann, C., 2001. Manipulation of salicylate content in *Arabidopsis thaliana* by the expression of an engineered bacterial salicylate synthase. *Plant J.*, **25**: 62–77.
- McDowell, M.J., and Woffenden, J.B., 2003. Plant disease resistance genes: recent insights and potential applications. *Trend. Biotech.*, **21**: 178–183.
- Métraux, J. P., 2002. Recent breakthroughs in the study of salicylic acid biosynthesis. *Tren. Plant. Sci.* **7**: 332–334.
- Métraux, J.P., Signer, H., Ryals, J., Ward, E., Wyss-Benz, M., Gaudin, J., Raschdorf, K., Schmid, E., Blum, W., and Inverardi, B., 1990. Increase in salicylic acid at the onset of systemic acquired resistance in cucumber. *Science*, **250**: 1004–1006.
- Meuwly, P., Mölders, W., Buchala, A., and Métraux, J. P. 1995. Local and systemic biosynthesis of salicylic acid in infected cucumber plants. *Plant Physiol.*, **109**: 1107–1114.
- Mitchell, J.A., Akarasereonont, P., Thiernemann, C., Flower, R.J., and Vane, J.R., 1993. Selectivity of nonsteroidal antiinflammatory drugs as inhibitors of constitutive and inducible cyclooxygenase. *Proc. Natl. Acad. Sci. USA.*, **90**: 11693–11697.
- Mittler, R., 2002. Oxidative stress, antioxidants and stress tolerance. *Tren. Plant. Sci.*, **7**: 405–410.
- Mou, Z., Fan, W.H., and Dong, X.N., 2003. Inducers of plant systemic acquired resistance regulate NPR1 function through redox changes. *Cell*, **113**: 935–944.
- Mölders, W., Buchala, A., and Métraux, J.-P., 1996. Transport of salicylic acid in tobacco necrosis virus-infected cucumber plants. *Plant Physiol.*, **112**: 787–792.
- Morris, S.W., Vernooij, B., Titatarn, S., Starrett, M., Thomas, S., Wiltse, C.C., Frederiksen, R.A., Bhandhufalck, A., Hulbert, S., and Uknes, S., 1998. Induced resistance responses in maize. *Mol. Plant-Microbe Inter.*, **11**: 643–658.
- Nandi, A., Moeder, W., Kachroo, P., Klessig, D. F., and Shah, J., 2005. The *Arabidopsis* *ssi2*-conferred susceptibility to *Botrytis cinerea* is dependent on *EDS5* and *PAD4*. *Mol. Plant-Microbe Interact.*, **18**: 363–370.
- Nandi, A., Welti, R., and Shah, J., 2004. The *Arabidopsis thaliana* dihydroxyacetone phosphate reductase gene *SUPPRESSOR OF FATTY ACID DESATURASE DEFICIENCY 1* is required for glycerolipid metabolism and for the activation of systemic acquired resistance. *Plant Cell*, **16**: 465–477.
- Nandi, A., Krothapalli, K., Buseman, M.C., Li, M., Enyedi, A., and Shah, J., 2003. *Arabidopsis* *sfd* mutants affect plastidic lipid composition and suppress dwarfing, cell death, and enhanced disease resistance phenotypes resulting from the deficiency of a fatty acid desaturase. *Plant Cell*, **15**: 2383–2398.
- Nawrath, C., and Métraux, J. P. 1999. Salicylic acid induction-deficient mutants of *Arabidopsis* express *PR-2* and *PR-5* and accumulate high levels of camalexin after pathogen inoculation. *Plant Cell*, **11**: 1393–1404.

- Nawrath, C., Heck, S., Parinthewong, N., and Métraux, J. P., 2002. EDS5, an essential component of salicylic acid-dependent signaling for disease resistance in *Arabidopsis*, is a member of the MATE transporter family. *Plant Cell*, **14**: 275-286.
- Neuenschwander, U., Vernooij, B., Friedrich, L., Uknes, S., Kessmann, H., and Ryals, J., 1995. Is hydrogen peroxide a second messenger of salicylic acid in systemic acquired resistance. *Plant J.*, **8**: 227-233.
- Niki, T., Mitsubara, I., Seo, S., Ohtsubo, N., and Ohashi, Y., 1998. Antagonistic effect of salicylic acid and jasmonic acid on the expression of pathogenesis-related (PR) protein genes in wounded mature tobacco leaves. *Plant Cell Physiol.*, **39**: 500-507.
- Norman-Setterblad, C., Vidal, S., and Palva, T. E. 2000. Interacting signal pathways control defense gene expression in *Arabidopsis* in response to cell wall-degrading enzymes from *Erwinia carotovora*. *Mol. Plant Micro. Inter.*, **13**: 430-438.
- Nürnbergger, T., and Brunner, F. 2002. Innate immunity in plants and animals: emerging parallels between the recognition of general elicitors and pathogen-associated molecular patterns. *Curr. Opin. Plant Biol.*, **5**: 318-324.
- Parker, J. E. 2003. Plant recognition of microbial patterns. *Tren. Plant Sci.*, **8**: 245-247.
- Pasquer, F., Isidore, E., Zarn, J., and Keller, B., 2005. Specific patterns of changes in wheat gene expression after treatment with three antifungal compounds. *Plant Mol. Biol.*, **57**: 693-707.
- Petersen, M., Brodersen, P., Naested, H., Andreasson, E., Lindhart, U., Johansen, B., Nielsen, H. B., Lacy, M., Austin, M. J., Parker, J. E., Sharma, S.B., Klessig, D. F., Martienssen, R., Mattsson, O., Jensen, A.B., and Mundy, J., 2000. *Arabidopsis* map kinase 4 negatively regulates systemic acquired resistance. *Cell*, **103**: 1111-1120.
- Pieterse, C. M. J., Ton, J. and Van Loon, L. C., 2001. Cross-talk between plant defense signaling pathways: boost or burden? *Ag.Biotech.Net*, **3**: 1-8.
- Pieterse, C. M. J., and Van Loon, L.C., 2004. NPR1: the spider in the web of induced resistance signaling pathways. *Curr. Opin. Plant Biol.*, **7**: 456-464.
- Pieterse, C. M. J., VanWees, S. C. M., Ton, J., Van Pelt, J. A., and Van Loon, L. C., 2002. Signalling in rhizobacteria-induced systemic resistance in *Arabidopsis thaliana*. *Plant Biol.*, **4**: 535-544.
- Pink, D. A. C., 2002. Strategies using genes for non-durable resistance. *Euphytica*, **1**: 227-236.
- Preston, C.A., Lewandowski, C., Enyedi, A.J., and Baldwin, I.T., 1999. Tobacco mosaic virus inoculation inhibits wound-induced jasmonic acid-mediated responses within but not between plants. *Planta*, **209**: 87-95.
- Rainsford, K. D., 1984. Aspirin and the salicylates. Butterworth, London.
- Raridan, G. J., and Delaney, T. P., 2002. Role of salicylic acid and NIMI/NPRI in race-specific resistance in *Arabidopsis*. *Genetics*, **29**: 439-451.
- Raskin, I., 1992. Role of salicylic acid in plants. *Annu. Rev. Plant Physiol. Plant Mol. Biol.*, **43**: 439-463.
- Rasmussen, J.B., Hammerschmidt, R., and Zook, M.N. 1991. Systemic induction of salicylic acid accumulation in cucumber after inoculation with *Pseudomonas syringae* pv *syringae*. *Plant Physiol.*, **97**: 1342-1347.
- Rate, D.N., Cuenca, J.V., Bowman, G.R., Guttman, D.S., and Greenberg, J.T., 1999. The gain-of-function *Arabidopsis acd6* mutant reveals novel regulation and function of the salicylic acid signaling pathway in controlling cell death, defenses, and cell growth. *Plant Cell*, **11**: 1695-1708.
- Ribnicky, D.M., Shulaev, V., and Raskin, I., 1998. Intermediates of salicylic acid biosynthesis in tobacco. *Plant Physiol.*, **118**: 565-572.

- Ross, A.F., 1966. Systemic effects of local lesion formation. In: Beemster ABR, Dijkstra J, eds. *Viruses of Plants*, Amsterdam, North-Holland. 127–150.
- Rüffer, M., Steipe, B., and Zenk, M. H., 1999. Evidence against specific binding of salicylic acid to catalase. *FEBS Lett.*, **377**: 175-180.
- Ryals, J.A., Neuenschwander, U.H., Willits, M.G., Molina, A., Steiner, H.Y., and Hunt, M.D., 1996. Systemic acquired resistance. *Plant Cell*, **8**: 1809–1819.
- Ryals, J., Weymann, K., Lawton, K., Friedrich, L., Ellis, D., Steiner, H.-Y., Johnson, J., Delaney, T.P., Jesse, T., Vos, P., and Uknes, S., 1997. The Arabidopsis *NIMI* protein shows homology to the mammalian transcription factor inhibitor I κ B. *Plant Cell*, **9**: 425–439.
- Schweigert, N., Zehnder, A. J. B., and Eggen, R. I. L., 2001. Chemical properties of catechols and their molecular modes of toxic action in cells, from microorganisms to mammals. *Environ. Microbiol.*, **3**: 81-91.
- Sekine, K.T., Nandi, A., Ishihara, T., Hase, S., Ikegami, M., Shah, J., and Takahashi, H., 2004. Enhanced resistance to Cucumber mosaic virus in the *Arabidopsis thaliana ssi2* mutant is mediated via an SA-independent mechanism. *Mol. Plant-Microbe Inter.*, **17**: 623-632.
- Serino, L., Reimann, C., Baur, H., Beyeler, M., Visca, P., and Hass, D., 1995. Structural genes for salicylate biosynthesis from chorismate in *Pseudomonas aeruginosa*. *Mol. Gen. Genet.*, **249**: 217–228.
- Shah, J., 2003. The salicylic acid loop in plant defense. *Curr. Opin. Plant. Biol.*, **6**: 365-371.
- Shah, J., 2005. Lipids, lipases and lipid modifying enzymes in plant disease resistance. *Annu. Rev. Phytopath.*, **43**: 229-260.
- Shah, J., Kachroo, P., and Klessig, D.F., 1999. The Arabidopsis *ssi1* mutation restores pathogenesis-related gene expression in *npr1* plants and renders Defensin gene expression SA dependent. *Plant Cell*, **11**: 191-206.
- Shah, J., Kachroo, P., Nandi, A., and Klessig, D.F., 2001. A recessive mutation in the Arabidopsis *SSI2* gene confers SA and NPR1-independent expression of PR genes and resistance against bacterial and oomycete pathogens. *Plant J.*, **25**: 563–574.
- Shah, J., and Klessig, D. F., 1999. Salicylic acid: signal perception and transduction. In: Hooykaas, P. P. J., Hall, M. A., Libbenga, K. R., eds., *Biochemistry and Molecular Biology of Plant Hormones*. Amsterdam, Netherlands: Elsevier. 513–541.
- Shah, J., Tsui, F., and Klessig, D.F., 1997. Characterization of a *salicylic acid insensitive mutant (sai1)* of *Arabidopsis thaliana*, identified in a selective screen utilizing the SA-inducible expression of the *tms2* gene. *Mol. Plant Microbe Inter.*, **10**: 69-78.
- Shirano, Y., Kachroo, P., Shah, J., and Klessig, D.F., 2002. A gain-of-function mutation in an Arabidopsis toll interleukin 1 receptor–nucleotide binding site–leucine-rich repeat type *R* gene triggers defense responses and results in enhanced disease resistance. *Plant Cell*, **14**: 3149–3162.
- Shirasu, K., Nakajima, H., Rajasekhar, V.K., Dixon, R.A., and Lamb, C., 1997. Salicylic acid potentiates an agonist-dependent gain control that amplifies pathogen signals in the activation of defense mechanisms. *Plant Cell*, **9**: 261–270.
- Shulaev V, Léon J, and Raskin I., 1995. Is salicylic acid a translocated signal of systemic acquired resistance in tobacco? *Plant Cell*, **7**: 1691–1701.
- Shulaev, V., Silverman, P., and Raskin, I., 1997. Airborne signalling by methyl salicylate in plant pathogen resistance. *Nature*, **385**: 718–721.
- Silverman, P., Seskar, M., Kanter, D., Schweizer, P., Métraux, J.-P., and Raskin, I., 1995. Salicylic acid in rice: biosynthesis, conjugation, and possible role. *Plant Physiol.*, **108**: 633-639.

- Singh, D. P., Moore, C. A., Gilliland, A., and Carr, J. P., 2004. Activation of multiple antiviral defense mechanisms by salicylic acid. *Mol. Plant Pathol.*, **5**: 57-63.
- Slaymaker, D.H., Navarre, D.A., Clark, D., Del Pozo, O., Martin, G.B., and Klessig, D.F., 2002. The tobacco salicylic acid-binding protein 3 (SABP3) is the chloroplast carbonic anhydrase, which exhibits antioxidant activity and plays a role in the hypersensitive defense response. *Proc. Natl. Acad. Sci. USA.*, **99**: 11640-11645.
- Smith, J. A., Hammerschmidt, R., and Fulbright, D. W., 1991, Rapid induction of systemic resistance in cucumber by *Pseudomonas syringae* pv. *syringae*. *Physiol. Mol. Plant Pathol.*, **38**: 223-235.
- Song, J.T., Lu, H., McDowell, J.M., and Greenberg, J.T., 2004. A key role for *ALDI* in activation of local and systemic defenses in Arabidopsis. *Plant J.*, **40**: 200-212.
- Spoel, S.H., Koornneef, A., Claessens, S.M.C., Korzelius, J.P., Van Pelt, J. A., Mueller, M. J., Buchala, A. J., Métraux, J.-P., Brown, R., Kazan, K., Van Loon, L. C., Dong, X., and Pieterse, C. M. J., 2003. NPR1 modulates cross-talk between salicylate- and jasmonate-dependent defense pathways through a novel function in the cytosol. *Plant Cell*, **15**: 760–770.
- Sticher, L., Mauch-Mani, B., and Métraux, J.P., 1997. Systemic acquired resistance. *Annu. Rev. Phytopathol.*, **35**: 235–270.
- Stout, M. J., Fidantsef, A.L., Duffey, S. S., and Bostock, R. M., 1999. Signal interactions in pathogen and insect attack: Systemic plant-mediated interactions between pathogens and herbivores of the tomato, *Lycopersicon esculentum*. *Physiol. Mol. Plant Pathol.*, **54**: 115–130.
- Stout, M. J., Workman, K.V., Bostock, R. M., and Duffey, S.S., 1998. Specificity of induced resistance in the tomato, *Lycopersicon esculentum*. *Oecologia.*, **113**: 74–81.
- Summermatter, K., Sticher, L., and Métraux, J. P., 1995. Systemic responses in *Arabidopsis thaliana* infected and challenged with *Pseudomonas syringae* pv. *syringae*. *Plant. Physiol.*, **108**: 1379-1385.
- Suzuki, H., Xia, Y., Cameron, R., Shadle, G., Blount, J., Lamb, C., and Dixon, R.A., 2004. Signals for local and systemic responses of plants to pathogen attack. *J. Exp. Bot.*, **55**: 169-179.
- Takahashi, H., Chen, Z., Du, H., Liu, Y., and Klessig, D.F. 1997. Development of necrosis and activation of disease resistance in transgenic tobacco plants with severely reduced catalase levels. *Plant J.*, **11**: 993-1005.
- Takahashi, H., Miller, J., Nozaki, Y., Sukamoto, Takeda, M., Shah, J., Hase, S., Ikegami, M., Ehara, Y., and Dinesh-Kumar, S.P., 2002. *RCY1*, an Arabidopsis thaliana *RPP8/HRT* family resistance gene, conferring resistance to cucumber mosaic virus requires salicylic acid, ethylene and a novel signal transduction mechanism. *Plant J.*, **32**: 655-667.
- Tenhaken, R., and Rubel, C., 1997. Salicylic acid is needed in hypersensitive cell death in soybean but does not act as a catalase inhibitor. *Plant Physiol.*, **115**: 291–298.
- Thaler, J. S., Fidantsef, A.L., Duffey, S. S., and Bostock, R. M., 1999. Trade-offs in plant defense against pathogens and herbivores: A field demonstration of chemical elicitors of induced resistance. *J. Chem. Ecol.*, **25**: 1597–1609.
- Torres, M. A., Dangl, J. L., and Jones, J. D. G., 2002. *Arabidopsis* gp91^{phox} homologues *AtrbohD* and *AtrbohF* are required for accumulation of reactive oxygen intermediates in the plant defense response. *Proc. Natl. Acad. Sci. USA.*, **99**: 517-522.
- Turner, J. G., Ellis, C., and Devoto, A., 2002. The jasmonate signal pathway. *Plant. Cell*, **14**: S153–S164.

- Uquillas, C., Letelier, I., Blanco, F., Jordana, X., and Holuigue, L., 2004. NPR1-independent activation of immediate early salicylic acid-responsive genes in Arabidopsis. *Mol. Plant Micro. Inter.*, **17**: 34-42.
- Vallélian-Bindschedler, L., Métraux, J. P., and Schweizer, P., 1998. Salicylic acid accumulation in barley is pathogen specific but not required for defense gene activation. *Mol. Plant Micro. Inter.*, **11**: 702-705.
- Van Loon, L.C., 2000. Systemic induced resistance. In *Mechanisms of Resistance to Plant Diseases*, ed. A.J. Slusarenko, R.S.S. Fraser, L.C. Van Loon, pp. 521-74. Dordrecht, Netherlands: Kluwer.
- Van Wees, S. C. M., and Glazebrook, J. 2003. Loss of non-host resistance of Arabidopsis NahG to *Pseudomonas syringae* pv. *phaseolicola* is due to degradation products of salicylic acid. *Plant J.*, **33**:733-742.
- Van Wees, S. C. M., De Swart, E. A. M., Van Pelt, J. A., Van Loon, L. C., and Pieterse, C. M. J., 2000. Enhancement of induced disease resistance by simultaneous activation of salicylate and jasmonate-dependent defense pathways in *Arabidopsis thaliana*. *Proc. Natl. Acad. Sci. USA.*, **97**: 8711-8716.
- Verberne M. C. Budi Muljono, A. B., and Verpoorte, R., 1999. Salicylic acid biosynthesis, In: Hooykaas, P. P. J., Hall, M. A., Libbenga, K. R., eds., *Biochemistry and Molecular Biology of Plant Hormones*. Amsterdam, Netherlands: Elsevier. 295-312.
- Vernooij, B., Friedrich, L., Morse, A., Reist, R., Kolditz-Jawhar, R., Ward, E., Uknes, S., Kessmann, H., and Ryals, J., 1994. Salicylic acid is not the translocated signal responsible for inducing systemic acquired resistance but is required in signal transduction. *Plant Cell*, **6**: 959-965.
- Vidal, S., Ponce de Léon, I., Denecke, J., and Palva, T. E., 1997. Salicylic acid and the plant pathogen *Erwinia carotovora* induce defense genes via antagonistic pathways. *Plant J.*, **11**: 115-123.
- Wang, K. L. C., Li, H., and Ecker, J. R., 2002. Ethylene biosynthesis and signaling networks. *Plant Cell*, **14**: S131-S151.
- Wang, D., Weaver, D.N., Kesharwani, M., and Dong, X., 2005. Induction of protein secretory pathway is required for systemic acquired resistance. *Science*, **308**: 1036-1040.
- Wasternack, C., Atzorn, R., Jarosch, B., and Kogel, K.H., 1994. Induction of a thionin, the jasmonate-induced 6 kDa protein of barley by 2,6-dichloroisonicotinic acid. *J. Phytopath.*, **140**: 280-284.
- Weissman, G., 1991. Aspirin. *Scient. Amer.*, **264**: 84-90.
- White, R. F., 1979. Acetylsalicylic acid (aspirin) induces resistance to tobacco mosaic virus in tobacco. *Virology*, **99**: 410-412.
- Wiermer, M., Feys, B.J., and Parker, J.E., 2005. Plant immunity: the EDS1 regulatory node. *Curr. Opin. Plant. Biol.*, **8**: 383-389.
- Wildermuth, M.C., Dewdney, J., Wu, G., and Ausubel, F.M., 2001. Isochorismate synthase is required to synthesize salicylic acid for plant defense. *Nature*, **414**: 562-565.
- Xiao, S., Brown, S., Patrick, E., Brearley, C., and Turner, J.G., 2003. Enhanced transcription of the Arabidopsis disease resistance genes *RPW8.1* and *RPW8.2* via a salicylic acid-dependent amplification circuit is required for hypersensitive cell death. *Plant Cell*, **15**: 87-95.
- Xu, Y., Chang, P. F. L., Liu, D., Narasimhan, M. L., Raghothama, K.G., Hasegawa, P. M., and Bressan, R. A., 1994. Plant defense genes are synergistically induced by ethylene and methyl jasmonate. *Plant Cell*, **6**: 1077-1085.

- Yang, Y., Qi, M., and Mei, C., 2004. Endogenous salicylic acid protects rice plants from oxidative damage caused by aging as well as biotic and abiotic stress. *Plant J.*, **40**: 909-919.
- Yalpani, N., Shulaev, V., and Raskin, I., 1993. Endogenous salicylic acid levels correlate with accumulation of pathogenesis-related proteins and virus resistance in tobacco. *Phytopath.*, **83**: 702-708.
- Yalpani, N., Silverman, P., Wilson, T.M.A., Kleier, D.A., and Raskin, I., 1991. Salicylic acid is a systemic signal and an inducer of pathogenesis-related proteins in virus-infected tobacco. *Plant Cell*, **3**: 809-818.
- Yoshioka, K., Kachroo, P.K., Tsui, F., Sharma, S.B., Shah, J., and Klessig, D.F., 2001. Environmentally-sensitive SA-dependent defense responses in the *cpr22* mutant of *Arabidopsis*. *Plant J.*, **26**: 447-459.
- Yu, D., Chen, C., and Chen, Z. 2001. Evidence for an important role of WRKY DNA binding proteins in the regulation of NPR1 gene expression. *Plant Cell*, **13**: 1527-1539.
- Yu, D., Liu, Y., Fan, B., Klessig, D.F., and Chen, Z. 1997. Is the high basal level of salicylic acid important for disease resistance in potato? *Plant Physiol.*, **115**: 343-349.
- Zhang, Y., Tessaro, M. J., Lassner, M., and Li, X., 2003. Knockout analysis of *Arabidopsis* transcription factors TGA2, TGA5, and TGA6 reveals their redundant and essential roles in systemic acquired resistance. *Plant Cell*, **15**: 2647-2653.

Chapter 13

TRANSCRIPTOMIC ANALYSIS OF SALICYLIC ACID-RESPONSIVE GENES IN TOBACCO BY-2 CELLS

I. GALIS and K. MATSUOKA

RIKEN Plant Science Center, 1-7-22 Suehiro-cho, Tsurumi-ku, Yokohama, JAPAN.

Abstract: Tobacco has played historically important role in the discovery and functional analysis of salicylic acid (SA) as a plant hormone. Using this model, it was demonstrated for the first time that tobacco mosaic virus (TMV) infection results in the accumulation of SA in infected tissues that is to activate local and systemic expression of pathogenesis-related proteins in the cells. Furthermore, SA has been shown to function as a major factor in the development of systemic acquired resistance (SAR) in plants. To promote the importance of tobacco as a model plant, we generated and sequenced cDNA libraries from tobacco BY-2 cells, depositing about 20,000 EST sequence information in the public databases. Selected cDNA clones were then used to prepare the first large-scale 16K microarray of tobacco. In this chapter, we describe our results of a large scale gene expression analysis, using the tobacco BY-2 cells, treated with a 40 μ M salicylic acid. In total, 376 genes (corresponding to individual ESTs) were at least 2-fold upregulated by SA, relative to their expression levels in control cells. Amid, a large number of genes overlapped with known defense-related genes in plants, whilst the others represented novel targets of SA in plants. The kinetic analysis of the SA-responsive genes, together with functional analysis of these genes in the plant defense, is presented in this chapter.

Key words: Global gene expression; microarray analysis; plant defense; salicylic acid; tobacco BY-2 cells.

1. INTRODUCTION

Tobacco is one of the widely used models in plant biology. In modern era of plant molecular biology, tobacco species gained importance especially because of the high success rate in *Agrobacterium*-based plant transformation systems, allowing easy generation of transgenic tobacco plants in early 90's. For example, tobacco was the first system to investigate the plant morphogenesis in plants harboring cytokinin synthesising gene, isopentenyltransferase (Smart *et al.*, 1991; Smigocki, 1991). In plant-pathogen interactions, tobacco mosaic virus (TMV) and tobacco are one of the most preferred models to investigate virus action in plants (Scholthof, 2004). It is not surprising that this model system was at the discovery of salicylic acid as new plant pathogenesis-related hormone (Malamy *et al.*, 1990). In the following years, a number of papers using tobacco as model system in plant-pathogen field have been published. However, the knowledge of genome-wide information of tobacco has been lacking for a long time, thus delaying further extension of the rich tobacco knowledgebase in comparison to other plant models, including *Arabidopsis* and rice.

In our laboratory, we started the contribution to improvement of tobacco transcriptomic information by sequencing large numbers of expressed sequence tags (EST) from normally grown tobacco Bright Yellow-2 (BY-2) cells as well as from the cells treated with various plant hormones, including SA. This cell culture, like that of the role of tobacco plants in plant-pathogen interactions, is an invaluable tool in the cell cycle-related research in plants (Section I in Nagata *et al.*, 2004). This work was initiated as a Transcriptome Analysis of BY-2 cells (TAB; <http://mrg.psc.riken.go.jp/strc/index.htm>) project with an aim to find and characterize novel and/or useful genes using tobacco BY-2 information.

At the same time, we initialized microarray-based screening of hormone responsive genes in tobacco cells. The first two reports included full description of tobacco methyl jasmonate transcriptome (Galis *et al.*, 2006) and partial descriptions of ABA and SA transcriptomes in the earlier paper (Matsuoka *et al.*, 2004). In this chapter, we present more detailed data describing SA-induced/repressed genes as a prerequisite for understanding the action of SA in tobacco.

2. MICROARRAY ANALYSIS

2.1 Microarrays as tool to understand plant gene expression networks

Since the beginning of this century, the progress by adopting sequencing technologies, together with development of high density printing tools which gave rise to high density DNA microarrays is satisfactory. DNA microarrays rapidly became the most powerful tool in (near) genome-wide transcriptome analysis of biological samples. Using microarray technology, the expression of (tens of) thousands of genes can be monitored simultaneously, envisaging global changes in transcription activity of the cells and most importantly, close interactions between the individual transcripts. This is critically important, for example, in the case of plant hormones that work in closely interacting networks, providing plasticity in response of the plants to environment as well as directing plant growth and development.

2.2 Microarrays in plant-pathogen interactions

The plants have usually no avoidance mechanisms to prevent injuries caused by insects, larger herbivores or other pathogens. Plants have, therefore, evolved competence, at the level of each cell, to activate defense responses, which largely depend on transcriptional activation of specific genes (Leon *et al.*, 2001).

Reflecting the above facts, substantial attention has been recently paid to the use of microarrays in plant-pathogen interactions. For example, De Vos *et al.*, (2005) used several pathogens with different modes of attack to monitor the dynamics of pathogen signaling and crosstalk between these signals in *Arabidopsis*. In first place, the response to attacker showed pathogen specific kinetics of SA, jasmonic acid and ethylene production, suggesting that plants respond differentially to these challenges. The conclusions of this comprehensive analysis suggest that, indeed, these hormones play a primary role in the orchestration of plant's defense response. In addition, the authors concluded that apart from general response, other regulatory mechanisms such as pathway crosstalk or additional attacker-induced signals, eventually shape the highly complex attacker specific defense response. It was shown that even the pathogens with very different modes of attack induce large number of overlapping genes that may be considered as universal response to stress in plants.

2.3 Microarrays in plant hormone action

In the previous example, natural pathogens were used, triggering production of at least three stress hormones, SA, jasmonic acid and ethylene. This approach typically brings highly complex responses that do not allow assignment of individual roles of plant hormones in the process. Alternatively, exogenous application of the hormone in the absence of pathogen can be used to identify genes that are under direct transcriptional control of the specific hormone, free from complex crosstalk interactions.

Currently, various plant hormones, as major regulators and housekeeping chemicals, have been centered by researchers and microarray analyses of hormone-treated plant tissues have been widely reported in the literature. A large scale *Arabidopsis* transcriptomic information is now available for development-specific hormones, cytokinins (Rashotte *et al.*, 2003), auxin (Goda *et al.*, 2004), brassinosteroids (Goda *et al.*, 2002; Goda *et al.*, 2004), gibberellins (Ogawa *et al.*, 2003) and stress/developmental signals in abscisic acid (Takahashi *et al.*, 2004), ethylene (Van Zhong *et al.*, 2003; De Paepe *et al.*, 2004), salicylic acid and methyl jasmonate (Schenk *et al.* 2000), ozone (Tamaoki *et al.*, 2003; Ludwikow *et al.*, 2004) and nitric oxide (Parani *et al.*, 2004). At the same time, information covering other model species is rapidly emerging, including microarray profiling of *Sorghum bicolor* plants (SA, methyl jasmonate and ethylene; Salzman *et al.*, 2005; abscisic acid, Buchanan *et al.*, 2005), *Medicago truncatula* (methyl jasmonate, Suzuki *et al.*, 2005), rice (abscisic acid, Yazaki *et al.*, 2004) and tobacco cells (methyl jasmonate, Galis *et al.*, 2006). The new results of SA-regulated gene expression in tobacco cells are presented as the main topic throughout the rest of this chapter.

3. MICROARRAY ANALYSIS OF SALICYLIC ACID ACTION IN TOBACCO CELLS

3.1 Hormone concentrations

While designing a microarray experiment, the concentration of hormone used in exogenous application must be considered carefully. Only physiologically relevant concentrations of hormone should be used to avoid non-specific adverse effects from overloading of the cells by the hormone.

In the case of SA, it also has to be considered that plant species contain highly variable levels of SA: for example the levels of free SA in mock-inoculated tobacco leaves are about 100 ng/g fresh weight and increase to as

much as 20 $\mu\text{g/g}$ fresh weight locally and 1.5 $\mu\text{g/g}$ fresh weight in systemic leaves after hypersensitive response (HR) induced by TMV (Enyedi *et al.*, 1992). Amounts of SA reported in cucumber phloem exudates after infection with tobacco necrosis virus (TNV) reached up to 7 μM concentrations (Metraux *et al.*, 1990), suggesting that 40 μM concentration of SA used to treat tobacco BY-2 cells may be within the expected physiological range of concentrations that function in plants, during stress response. Furthermore, SA is rapidly metabolized to *O*- β -D-glucosyl-SA and other minor conjugates in tobacco (Enyedi *et al.*, 1992). It is then expected that exogenously applied SA to BY-2 cells can be rapidly metabolized, resulting in transient character of response of the cells at the gene expression level.

3.2 Transient character of SA response in BY-2 cells

This expectation was confirmed experimentally as described in Figure 1. It shows that 48 hours after the application of SA, the treated and control cells have very similar expression levels of the vast majority of examined transcripts. In contrary and despite to comparable concentrations of the hormones, our previous results suggest that methyl jasmonate-induced changes in tobacco are substantially more profound, resulting in highly diversified cell expression profiles at 48 hours (Galis *et al.*, 2006).

This may suggest that SA mounts defense mainly by the activation of genes with immediate protective function, while JA regulates more complex changes in the cells, including cessation of cell division (Swiatek *et al.*, 2002) and mounting of physical barriers, including repair of damaged tissues that prevent the spread of pathogen (Goossens *et al.*, 2003; Galis *et al.*, 2006).

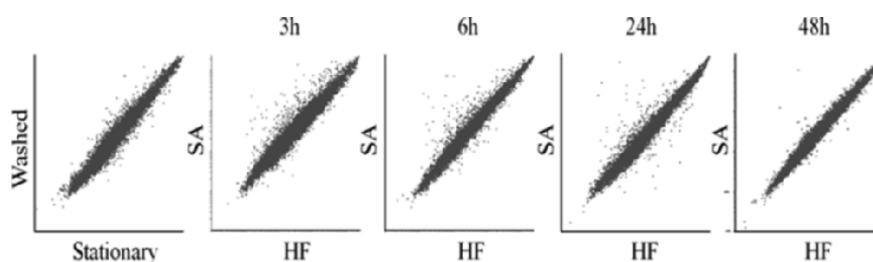

Figure 1. Scatter plots of HF (control) and SA-treated cells. On the most left, the cells after washing are plotted against stationary cells at the beginning of the experiment. Next, the raw expression data for each gene in control (x-axes) and SA-treated samples (y-axes) at individual time points are plotted against each other. This analysis shows that the cells at 48 hours have very similar gene expression in both control and treated samples. Also, at 3h and 6h, the upregulated genes by SA clearly prevail over the downregulated transcripts.

3.3 Numbers of SA-regulated genes

We compared the number of genes with 2-fold induction (repression) by SA in three independent experiments using tobacco cells, *Sorghum* (Salzman *et al.*, 2005) and *Arabidopsis* (Schenk *et al.*, 2000) plants (Table 1). However, these results do not allow a simple alignment due to substantial differences in experimental approaches and concentrations of exogenous SA. Nevertheless, it can be estimated that there are at least several hundreds of genes that can respond to SA in plants. This induction occurs at as low as 40 μM SA (tobacco cells) and can be manifested through root uptake (*Sorghum*) as well as by direct spray and diffusion of SA in the leaves of *Arabidopsis*. It suggests that gene regulation by SA occurs in dicotyledonous as well as in monocotyledons species. Furthermore, the functional groups of genes that were represented in all the three experiments show significant overlapping, allowing partial generalization of the results.

Table 1. Comparison of genes that show at least 2-fold induction (repression) in three independent experiments with tobacco (this chapter), monocot grass *Sorghum bicolor* (Salzman *et al.*, 2005) and *Arabidopsis thaliana* (Schenk *et al.*, 2000). Table shows the differences in experimental designs between the individual experiments.

Plant species	<i>Nicotiana tabacum</i>		<i>Sorghum bicolor</i>				<i>Arabidopsis thaliana</i>	
Application	Suspension culture		Hydroponic through roots				Spray on the leaves	
Concentration	40 μM		1 mM				4 mM	
Size of array	16,224		12,982				2,375	
Redundancy	yes		no				no	
Biased selection	no		no				Defense genes	
Tissue	Cell culture		Roots		Shoots		Leaves	
Regulated	up	down	up	down	up	down	up	down
3 hours	249	46	569	60	1141	452		
6 hours	181	29						
24-27 hours	156	33	988	19	674	377	263	144
48 hours	11	12						

3.4 Kinetic properties of tobacco SA-induced genes

In our experiments, we mostly collected the expression data from several independent time points to assess the behavior of individual transcripts in response to hormone treatments. Although the BY-2 cells are cytokinin-autonomous, they still require auxin for successful proliferation in the culture. As we prefer to use rather non-dividing cells in the analyses, the

cells are usually kept in auxin-free media during the experiment. A typical experimental setup then includes (i) washing of stationary phase (S; 7-day-old) cells in the medium devoid of auxin, 2,4D (see details in Galis *et al.*, 2006), (ii) transfer of washed (W) cells into fresh auxin-free medium supplied with hormone in test and (iii) cultivation of the cells for another 48h with samplings at 3h, 6h, 24h and 48h time points. Simultaneously, samples from untreated cells (hormone-free; HF) were collected and used for comparison.

We use the kinetic properties of the gene expression as one important parameter during functional analysis of the transcripts. This approach, for example, helps to identify genes with immediate response to the hormone and the genes with indirect (late) regulation. It can also help to identify possible key regulators of hormone action; in the previous work, we identified a novel methyl jasmonate-controlled MYB transcription regulator of phenylpropanoid genes because it was apparently co-expressed with its target genes (Galis *et al.*, 2006).

In the recent microarray experiment, we used a 2-fold induction (suppression) threshold for SA-upregulated (downregulated) genes. In our analysis, we only included data points that showed increase (decrease) in two independent replicates of the experiment, applying the strictest criteria on the selection of genes. Under these criteria, out of 16,224 cDNA spots, we found 376 spots that were induced by SA at one or more time points of the experiment and 85 spots with suppressed signals, relative to the signals in control samples.

We then classified the upregulated genes, using Self Organizing Maps (GeneSpring software, Silicon Genetics) to seven groups with specific expression profiles (Fig. 2). In general, SA-induced genes were divided into constitutively induced group A (14 ESTs), transcripts with transient induction (groups B, 82; C, 135; D, 56 ESTs) and genes that were highly expressed in stationary cells but rapidly suppressed after being transferred to a fresh, nutrient-rich medium (group E, 24 ESTs). In contrast, the salicylate-treated cells in the group E showed rather slower suppression than control cells. Similar pattern was also typical for genes in group F (54 ESTs) which showed transient decrease in expression in control cells but remained rather constitutively expressed in SA-treated cells. The last group G contained 11 mostly redundant transcripts (five ESTs belonging to the expressed unknown homologue of the *Arabidopsis* protein, At3g49570) with peak of expression at 3h in both SA and control cells.

Considering the stress-related character of SA signal, the transient profiles in groups B, C and D suit the best to this established function. Expectedly, many of the genes involved in defense response were expressed with these profiles (Table 2).

The profiles in group E and F evoke speculation that the stationary BY-2 cells may contain certain level of SA, imposed on the cells as a result of culture/nutritional stress in fully grown, 7-day-old culture. Soon after transfer to fresh medium, the stress level may have got alleviated, resulting in decrease of active SA and simultaneous drop in expression of SA (stress)-responsive genes. A close-to-identical gene for tobacco UDP-glucose: salicylic acid glucosyltransferase (BP535220) was expressed with F group profile, suggesting that, indeed, the stationary cells may produce free SA. On the other hand, these genes may be under a dual control of SA and some other stress-related signals, including ROS and NO.

The most peculiar constitutive expression profile in group A was of the BP533512, a TID771 tumor-related protein of hybrid *Nicotiana glauca* x *Nicotiana langsdorffii* tobacco plants (Fujita *et al.*, 1994). This gene showed remarkable, an overall highest induction of all genes on the tobacco array. The expression of this gene is associated with late stages of genetic tumor development in the interspecific tobacco hybrids (Fujita *et al.*, 1994). In fact, another SA-induced clone (BP533071) is identical to expansin-like TID301 that was also preferentially expressed in tobacco genetic tumors, together with other pathogen response-related transcripts (glucan endo-1,3- β -glucosidase, proteinase inhibitor, PR1-like proteins and osmotin), suggesting that SA and/or other stress signals may be actively involved in the development and/or maintenance of genetic tumors in tobacco.

3.5 SA-induced metabolic genes

3.5.1 Non-redundant gene list of induced genes

The non-redundant list of genes induced by SA in BY-2 cells is summarized in tables 2 and 3. Table 2 includes 156 metabolic genes or genes with unknown function and table 3 contains 45 genes with putative regulatory function in SA action. Remaining 143 EST sequences showed no homology to known genes. These transcripts represent a pool of novel genes with unknown function that could be involved in yet uncharacterized cellular processes. Because of the space limitations of this chapter, we excluded these ESTs, and additional redundant EST clones from the current analysis and data presented in Tables 2 and 3.

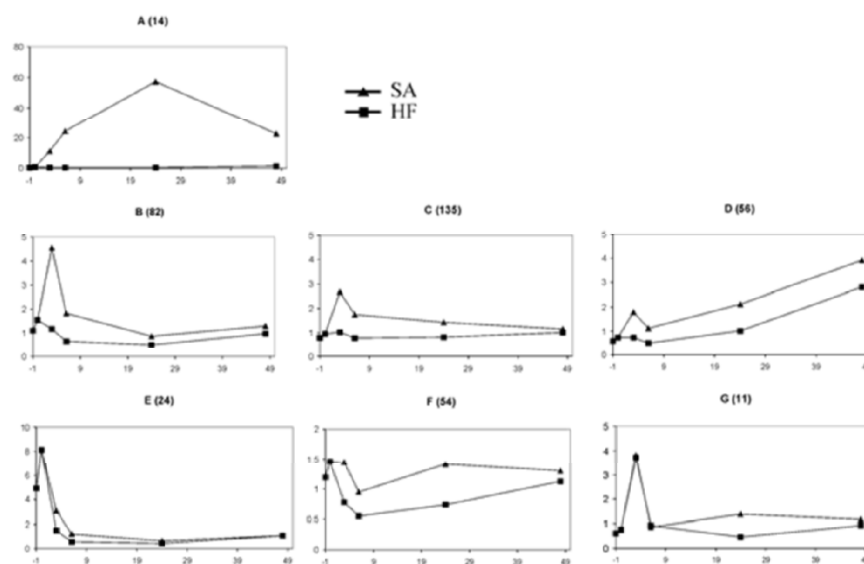

Figure 2. SA-induced transcripts were classified into SOM groups depending on their expression profile in the time course of the experiment. The graphs show average expression in the group and numbers in brackets indicate number of individual ESTs, classified in the group.

Where possible, we divided tobacco and *Arabidopsis* genes into groups similar to *Sorghum* data (Salzman *et al.*, 2005) and compared the functional classes of SA-inducible genes in these species. In agreement with demonstrated role of SA in plant defense, the genes involved in response to oxidative stress and pathogen defense represented the most abundant groups of SA-upregulated transcripts.

3.5.2 Redox potential of the SA-treated cells

Pathogen attack is often accompanied by induction of oxidative burst in plant cells. This burst involves formation of reactive oxygen intermediates (ROI) that have detrimental effect on the pathogen as well as on plant cells. Because ROI also participate in signaling events, the cells must use various antioxidant systems to control the level of free radicals in the cells (Foyer and Noctor, 2005; De Gara *et al.*, 2003). Major ROI scavenging mechanisms in plants include superoxide dismutase (SOD), ascorbate peroxidase (APX) and catalase (CAT) (reviewed by Mittler 2002).

In rice, which naturally contains high levels of free SA, this hormone is required for natural protection from oxidative damage. It was shown that SA-deficient rice plants contain elevated levels of superoxide and hydrogen

peroxide (H_2O_2), and exhibit spontaneous lesion formation in an age- and light-dependent manner (Yang *et al.*, 2004). In contrary, some literature data suggest that SA increases the levels of intracellular H_2O_2 through inhibition of CAT activity, although different CAT isoenzymes showed marked differences in SA sensitivity (De Gara *et al.*, 2003). These data suggest that SA actively contributes to regulate redox homeostasis in plant cells but the exact role of SA needs to be carefully considered. Here, a global expression data may help to elucidate the role of SA in this process.

The maintenance of high reduced/oxidized ratio of ascorbate and glutathione is essential for proper scavenging of ROI in the cells (Mittler 2002). Among others, this ratio is maintained by glutathione reductase which is induced in response to SA in tobacco cells. In addition, glutaredoxin, thioredoxin H, protein disulphide isomerase (PDI) and several anionic peroxidases were among tobacco SA-induced genes. Furthermore, Cu-Zn SOD, catalase, glutathione peroxidase and glutathione disulphide reductase were induced by SA in *Sorghum*, suggesting that SA controls variety of genes, involved in the regulation of redox status of the cells. However, the most abundant group of redox/detoxification-related genes in both plant species is represented by various isoforms of glutathione-S-transferase proteins (GSTs). Stress-inducible GSTs catalyze the formation of glutathione-xenobiotic conjugates, a key step in their metabolic detoxification. In *Arabidopsis*, specific members of GST family respond to SA with differences in terms of magnitude, timing and dose response (Sappl *et al.*, 2004). The first phase of GST conjugation involves oxidative activation of xenobiotic substrate that is mainly catalyzed by cytochrome P450 system (Frova 2003). A number of cytochrome P450-related proteins can be found among SA-induced genes in all three species, i.e. tobacco, *Sorghum* and *Arabidopsis*. In addition, some GSTs possess glutathione-dependent peroxidase activity thus playing direct role in prevention of oxidative damage (Frova 2003).

3.5.3 Phenylpropanoid pathway

The main source for building physical barriers is associated with secondary metabolism of plants, mainly phenylpropanoid pathway-derived components of cell walls, lignins. Other phenylpropanoid-derived substrates include flavonoids, tannins and hydroxycinnamate esters. These compounds have broad biological activities in stress responses, acting as chemical deterrents to herbivores and pathogens, antifungal compounds and screening filters against harmful ultraviolet (UV) radiation (Bieza and Lois 2001; Ryan *et al.*, 2001). They also act as likely scavengers of free radicals and other oxidative species through their hydrogen donating (antioxidant) potential

(Grace and Logan 2000). For example, chlorogenate and caffeate were more effective antioxidants in the ABTS⁺ radical scavenging test than the “classical” antioxidant ascorbate (Grace and Logan 2000).

In this context, the activation of phenylpropanoid metabolism by SA plays important role in defense response of the plant cells. As mentioned previously, the activation of phenylpropanoid metabolism in methyl jasmonate-treated BY-2 cells was much more profound than in SA-treated cells (Galis *et al.*, 2006 and this chapter). This may be related to the fact that while methyl jasmonate functions as main coordinator in wound response and repair of damaged tissues, SA may have more specific role in the synthesis of specialized phytoalexins with antibacterial and antifungal properties in the cells. It is well known, that TMV infection and SA-dependent development of HR in tobacco are closely associated with accumulation of highly fluorescent coumarins around the lesions, suggesting that these phenolic compounds play important role in development of HR (Gachon *et al.*, 2004; Goy *et al.*, 1993).

The main transcripts induced by SA in *Sorghum* included chalcon synthase and metabolic enzymes in flavonoid synthesis, and cinnamyl-alcohol dehydrogenase for lignin biosynthesis. However, the levels of induction of the key input-controlling phenylpropanoid gene, phenylalanine ammonia-lyase (PAL), were within 1.6-2.2-fold range, showing that even the 1mM concentration of SA is not able to promote the expression of this gene at substantial level. In *Phaseolus vulgaris* plants, the PAL gene was also marginally induced in the leaves by 1 mM SA which was wick-fed through the vasculature of the plants (Galis *et al.*, 2004). In tobacco cells, PAL and other backbone phenylpropanoid genes 4-coumarate:CoA ligase (4CL) and caffeic acid 3-O-methyltransferase (COMT) were all upregulated by SA, showing rather mild induction over the time course of the experiment. In contrast, two phenylpropanoid:glucosyltransferase-related genes from tobacco (BP136191; BP526618; Fraissinet-Tachet *et al.*, 1998) were induced with strong transient peak at 3h.

A number of cytochrome P450 enzymes with unknown function can be found in all three species, among SA-inducible genes. Some of these P450's are very strongly induced, especially in *Sorghum* roots (3 h and 27 h) and shoots at 3 h. The monooxygenase activity of these enzymes is often required for phenolic biosynthesis and some of these genes then may represent novel genes from this pathway (Dixon and Paiva, 1995).

3.5.4 Alkaloid biosynthesis

A clear difference in alkaloid accumulation exists between SA and methyl jasmonate-hormone generated signals. While jasmonates strongly

induced alkaloid biosynthetic pathway in tobacco (Goossens *et al.*, 2003; Galis *et al.*, 2006), this was not observed with SA. It suggests that the role of tobacco alkaloids in defense response differs significantly, attributing the main defense function of tobacco nicotine derivatives to jasmonate-mediated resistance against mechanical wounding-associated pathogens, insects and larger herbivores.

3.5.5 Pathogenesis-related genes

Various defense-related transcripts, outline one of the most abundant groups of SA-induced genes. These transcripts include canonical pathogenesis-related (PR) proteins, heat shock proteins (chaperones), protease inhibitors, proteases and various pathogen-inducible transcripts with putative function in plant defense.

The PR proteins, produced by the host plant, under stress conditions, have been classified into 14 families, denoted as PR-1 to PR-14. Many of these proteins have been characterized and shown to possess specific enzymatic activities (PR-2, β -1,3-glucanases; PR-3, PR-4, PR-8 and PR11, chitinases; PR-9, peroxidase; Gozzo, 2003; Veronese *et al.*, 2003). Surprisingly, the molecular function of molecular markers of SAR, acidic PR-1 type proteins, has not yet been clearly established (Uknes *et al.*, 1993). Microarray results show expected induction of various PR proteins in all three studied species, namely PR-1 proteins (tobacco, *Sorghum* and *Arabidopsis*), various chitinases (*Sorghum*), β -1,3-glucanases (tobacco and *Sorghum*) and thaumatins (PR-5; *Sorghum* and *Arabidopsis*).

Another type of SA-induced defense-related genes found in tobacco and *Sorghum* are broad substrate specific, ATP-binding cassette (ABC) transporters. In the plant cells, the transport of alkaloids and vacuolar sequestration of various glucosides of endogenous secondary metabolites and xenobiotics, glucuronides and glutathione conjugates are mediated by multidrug resistance-associated protein (MRP)-type ABC transporters (Yazaki, 2005).

3.5.6 Interactions with other hormones

In plant-pathogen interactions, it is often observed that one hormone influences its own synthesis or that of other hormones in the cells. For example, exogenous application of jasmonic acid induces self amplification loop of JA biosynthesis (Goossens *et al.*, 2003; Kubigsteltig and Weiler, 2003; Galis *et al.*, 2006). In the case of SA biosynthesis, both routes using (i) phenylalanine, cinnamic and benzoic acids or (ii) isochlorogenic acid intermediates have been proposed (Metraux, 2002). The current microarray

results do not allow exact tracking of SA-induced SA biosynthesis in tobacco or *Sorghum*, however, both these data suggest an active crosstalk of jasmonic acid and ethylene with SA. In both species, the expression of the rate limiting allene oxide synthase gene in JA biosynthesis (Kubigsteltig and Weiler, 2003) was induced by SA, together with another enzyme, 12-oxophytodienoate reductase. Moreover, the Lox1 lipoxygenase implied in JA biosynthesis was induced in *Arabidopsis* microarray. Furthermore, several genes for sensing the ethylene signal were induced by SA in all three species, under study.

The induction of UDP-glucose:salicylic acid glucosyltransferase gene in tobacco and upregulation of S-adenosyl-L-methionine:salicylic acid carboxyl methyltransferase in *Sorghum* suggest that the exogenously applied SA is rapidly metabolized in these species (Seskar *et al.*, 1998).

3.5.7 Miscellaneous metabolism

In tobacco and *Sorghum*, induction of a number of glucosyltransferases (GTs) by SA could represent the response of the cells to the presence of various free GT substrates, including SA and phenylpropanoids within the cells. As mentioned earlier, glucosylation and sequestration of cytotoxic substrates represent one of the major defense mechanisms in the cells (Bowles *et al.*, 2005; Yazaki, 2005). In *Sorghum*, majority of GTs belonged to flavonol glucosyltransferases, thus being related to phenylpropanoid metabolism. Simultaneously, several β -glucosidases were remarkably induced by SA, suggesting for the occurrence of active metabolic transitions in SA-treated *Sorghum* cells.

In summary, all these independent experiments denote large variety of metabolic genes that change their expression in response to exogenous SA, suggesting that SA has pleiotropic effect on various cellular processes, including ion transport, photosynthesis, amino acid metabolism, nucleic acid metabolism and others.

3.6 SA-induced regulatory genes

3.6.1 Overview of regulators

Many plant defense genes, under transcriptional regulation of SA, jasmonic acid and ethylene, have already been identified (Thatcher *et al.*, 2005). However, we still lack knowledge about the intrinsic regulatory elements, involved in coordination of expression of these genes. Reflecting

BP130185	BY2126	2.00E-29	a	expressed protein At1g14870	At	0.2	0.8	0.2	0.1	0.2	1.5	1.8	1.2	1.5	1.4
BP135896	BY8447	3.00E-17	f	expressed protein At1g23710	At	0.8	1.3	0.6	0.5	0.9	1.0	1.4	1.1	1.2	0.9
BP134497	BY6896	3.00E-09	d	expressed protein At3g21710	At	0.8	1.0	0.5	0.5	0.9	1.8	1.1	0.9	1.7	2.8
BP534005	BY31337*	7.00E-11	g	expressed protein At3g49570	At	0.2	0.3	3.8	0.9	0.4	0.9	3.0	0.7	1.4	1.3
BP535405	BY35245	3.00E-10	b	expressed protein At4g29330	At	0.8	0.7	2.0	1.0	0.7	1.2	5.3	1.7	0.7	1.0
BP136757	BY9375	3.00E-51	c	expressed protein At5g13210	At	0.9	1.4	1.7	0.3	1.1	0.5	2.5	0.7	1.1	0.9
BP531586	BY25106	2.00E-10	g	expressed protein At5g24660	At	0.3	0.4	4.8	1.1	0.4	0.9	3.7	0.7	1.4	1.3
BP529218	BY14108	3.00E-06	c	hypothetical protein At1g11220	At	0.9	1.2	0.9	1.1	0.7	0.8	1.7	1.1	3.0	1.1
BP135114	BY7587	0.00013	c	hypothetical protein At3g13130	At	0.8	1.0	0.7	0.4	0.5	1.2	2.9	3.6	2.0	1.1
BP134919	BY7371	2.00E-19	f	hypothetical protein At4g02880	At	1.9	1.7	1.1	0.7	0.8	1.0	1.3	1.6	0.9	0.9
BP529343	BY14237	2.00E-28	g	hypothetical protein At5g42610	At	0.8	1.3	2.4	1.0	0.7	0.7	2.9	1.1	2.0	0.9
BP131163	BY3190	5.00E-28	c	hypothetical protein At5g43390	At	0.6	1.7	2.4	0.3	1.0	0.5	5.5	0.7	1.4	0.6
BP135927	BY8478	1.00E-09	f	hypothetical protein OSJNBa0040E01.12	Os	1.2	1.4	0.8	0.5	0.7	0.7	1.5	1.2	1.1	1.0
BP133583	BY5864	3.00E-05	f	hypothetical protein OSJNBa0070N04.16	Os	1.5	1.4	0.4	0.6	0.9	1.3	0.6	0.9	2.0	1.6
BP135438	BY7949	4.00E-06	c	hypothetical protein OSJNBa0086P08.14	Os	0.9	1.5	0.8	1.0	0.9	1.1	2.5	1.5	1.1	1.2
BP133572	BY5852	5.00E-08	c	hypothetical protein OSJNBa0093P23.15	Os	0.4	0.4	1.0	0.7	0.6	1.3	5.8	2.5	0.9	1.6
BP133665	BY5955	2.00E-06	c	hypothetical protein T32O22.13	At	0.8	1.4	0.8	0.8	1.4	0.9	2.3	1.4	2.0	1.0
BP532574	BY27380	1.00E-23	c	unknown B2 protein	Dc	0.9	1.1	0.9	0.4	0.6	1.3	1.8	1.2	0.5	1.6
BP531994	BY26154	6.00E-07	f	unknown Pi starvation induced protein	Nt	1.6	1.8	1.1	0.7	0.6	0.7	1.7	1.7	0.6	1.2
BP530034	BY21011	4.00E-68	d	unknown pRIB5 protein [imported]	Rn	0.4	0.4	0.5	0.7	1.0	2.9	1.9	1.1	1.4	2.9

The overall examination of regulators, induced by SA application in tobacco shows that the most abundant regulatory class are protein kinases/phosphatases, followed by various transcription factors (Fig. 3; Tab. 3). Analysis of *Sorghum* and *Arabidopsis* transcriptomes shows virtually same spectrum of SA-induced regulators in these plant species. In addition, a significant number of GTP-binding proteins were induced by 1 mM application of SA in *Sorghum*.

3.6.2 Protein kinases

One of the most important regulatory mechanisms in living organism involves phosphorylation of target proteins by protein kinases. The mitogen-activated protein (MAP) kinases have been implicated in stress response signal transduction as well as in the regulation of mitotic activities of the cells. The activation of SA-dependent tobacco protein kinase (SIPK) was shown to be required for activation of tobacco defense genes and induction of hypersensitive response (Zhang and Klessig, 1997; Zhang and Liu, 2001). The activation of SIPK by SA occurs at posttranslational level by phosphorylation with MAP kinase kinase, NtMEK2 (Yang *et al.*, 2001). The identity of MAPKK kinase, required for phosphorylation of NtMEK2 is still unknown (reviewed by Pedley and Martin, 2005). Even though the phosphorylation cascade by MAP kinases is independent of transcription, several MAP kinase-like genes in *Sorghum*, *Arabidopsis* AtMPK3 and tobacco MAP kinase kinase (BP530009) were induced by SA at transcription level, suggesting that these genes may also be under transcriptional control of SA.

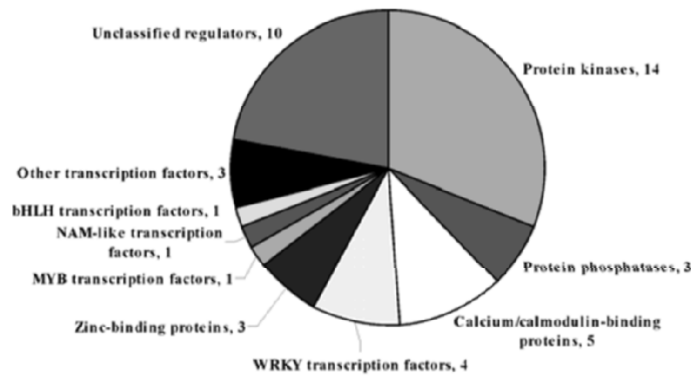

Figure 3. Schematic representation of SA-induced regulatory genes in tobacco BY-2 cells. A list of 45 SA-induced regulators in tobacco was divided into 10 classes based on functional analysis of the nearest database homologues of the transcripts.

Other classes of SA-transcriptionally-induced protein kinases in tobacco, *Sorghum* and *Arabidopsis* involve receptor-like protein kinases and serine/threonine protein kinases, suggesting that phosphorylation process is dynamically involved in SA-regulated stress signal transduction.

3.6.3 Transcription factors

Transcription factors mediate a variety of cellular signals to endogenous gene expression. The major classes of transcription factors involved in defense response have been reviewed, for example, by Singh *et al.* (2002) and Thatcher *et al.* (2005). Among others, it has been shown that many of the pathogen- and/or SA-responsive genes are regulated by WRKY-type transcription factors that interact with W-box sequences in the promoters of target genes (Eulgem *et al.*, 2000; Dong *et al.*, 2003). For example, the promoter of an important regulator of PR genes, NPR1, contains several W-box motifs and when these are mutated, promoter activity is abolished in response to SA (Thatcher *et al.*, 2005).

In microarray-examined species, the transcripts of large variety of transcription factors accumulated in the presence of SA. These include several WRKY proteins, zinc finger proteins and other classes of transcription factors. Further, functional analysis of these proteins is required to reveal their function in SA-signal transduction and regulation of target (defense) genes expression.

3.6.4 Other regulatory elements

A number of regulations in the cells occur via specific protein-protein interactions. For example, it has been shown that SA activation of PR protein expression depends on ankyrin repeat type protein NPR1, which binds to bZIP-type TGA transcription factors. The NPR1-TGA protein complex then binds to SA-responsive elements in the PR genes and activates their expression (Pieterse and Van Loon, 2004; Eulgem, 2005). Protein interaction domains can be found in some of the tobacco, *Sorghum* and *Arabidopsis* SA-induced genes, suggesting that these proteins may be involved in the regulation of SA action by interacting with other proteins, including transcription factors.

In addition, calcium binding proteins also belong to SA-induced class of genes, showing that calcium fluxes may also be directly involved in SA action.

The group of the genes with emerged regulatory role is the ubiquitin/26S proteasome-related group of genes. It appears that number of processes in plant growth and development are controlled by the selective removal of short lived regulatory proteins (e.g. cell division, DNA repair, light and phytohormone signaling) through ubiquitin/26S proteasome-mediated degradation. In this system, specific transcription factors/repressor proteins are recognized by the interacting F-box proteins, ubiquitylated and subsequently degraded by the 26S proteasome (Thomann *et al.*, 2005). Among plant hormones, ubiquitin controlled degradation was found in signaling pathways of auxin, jasmonic acid, gibberellin and ethylene (Thomann *et al.*, 2005). In addition, TIR1 F-box protein has been found to encode an auxin receptor in *Arabidopsis* (Dharmasiri *et al.*, 2005; Kepinski and Leyser, 2005). In SA action, it has been shown that a specific F-box protein SON1 acts as negative regulator of defense responses in *Arabidopsis* (Kim and Delaney, 2002).

In *Sorghum* and *Arabidopsis* microarrays, there are several SA-activated ubiquitin-protein ligases, RING zinc finger proteins and genes encoding polyubiquitin, suggesting that at least some of the components of the ubiquitylation machinery are required for SA action. However, in all the three array results, there were virtually no upregulated typical F-box proteins, which function as important recognition determinants in the ubiquitin/proteasome system, targeting specific proteins for degradation.

An important regulator EDS1 was induced in tobacco and *Sorghum* (shoots/3 h). This protein with homology to lipase is an interactor of PAD4 that cooperates in defense signaling (Wiermer *et al.*, 2005). Furthermore, another important regulator of defense response, putative seven trans-

3.7 Suppressed genes

Interestingly, *Sorghum* roots and tobacco BY-2 cells showed relatively low number of SA-suppressed genes. In contrast, green and photosynthetically active tissues of *Sorghum* and *Arabidopsis* contained substantially higher numbers of SA-downregulated transcripts (Table 1), suggesting that these tissues may respond differentially to SA signal.

Functional classification of SA-suppressed genes, particularly in the green tissues, shows that SA negatively affects the process of cell proliferation. Number of proteins involved in DNA replication and proteosynthesis, including histones, tubulins, elongation factors, RNA helicases and ribosomal proteins were downregulated by SA in *Sorghum* and, to a lower extent, also in tobacco cells (Table 4).

Furthermore, a number of regulatory proteins have been downregulated 2 to 5-fold in *Sorghum* and *Arabidopsis* green tissues. Further analysis of these transcripts will be required to gain full understanding of their role in SA-mediated plant defense.

4. CONCLUSIONS

We have used a moderate concentration of salicylic acid to examine the response of tobacco cells to this plant hormone. In comparison to two other large scale expression analyses of SA-regulated genes, tobacco produced significantly similar lists of functionally classified genes as the other two objects, classical plant model *Arabidopsis thaliana* and monocot grass *Sorghum bicolor*. In particular, the cells showed enhanced expression of defense-related genes as well as activation of a number of regulatory proteins that are under transcriptional control of SA. Future detailed analysis of these proteins will contribute to elucidation of complex mechanisms that provide plant protection against variable environmental stress, including plant pathogens. In conclusion, this work has proven the useful potential of microarray analysis in understanding SA action and also supported the role of salicylic acid as one of the classical hormones in plants.

5. REFERENCES

- Bieza, K., and Lois, R., 2001. An *Arabidopsis* mutant tolerant to lethal ultraviolet-B levels shows constitutively elevated accumulation of flavonoids and other phenolics. *Plant Physiol.*, **126**: 1105-1115.
- Bowles, D., Isayenkova, J., Lim, E. K., and Poppenberger, B., 2005. Glycosyltransferases: managers of small molecules. *Curr. Opin. Plant Biol.*, **8**: 254-263.

- Buchanan, C. D., Lim, S. Y., Salzman, R. A., Kagiampakis, L., Morishige, D. T., Weers, B. D., Klein, R. R., Pratt, L. H., Cordonnier-Pratt, M. M., Klein, P. E., and Mullet, J. E., 2005. *Sorghum bicolor*'s transcriptome response to dehydration, high salinity and ABA. *Plant Mol. Biol.*, **58**: 699-720.
- De Gara, L., de Pinto, M. C., and Tommasi, F., 2003. The antioxidant systems vis-a-vis reactive oxygen species during plant-pathogen interaction. *Plant Physiol. Biochem.*, **41**: 863-870.
- De Paepe, A., Vuylsteke, M., Van Hummelen, P., Zabeau, M., and Van Der Straeten, D., 2004. Transcriptional profiling by cDNA-AFLP and microarray analysis reveals novel insights into the early response to ethylene in *Arabidopsis*. *Plant J.*, **39**: 537-559.
- De Vos, M., Van Oosten, V. R., Van Poecke, R. M. P., Van Pelt, J. A., Pozo, M. J., Mueller, M. J., Buchala, A. J., Mettraux, J. P., Van Loon, L. C., Dicke, M., and Pieterse, C. M. J., 2005. Signal signature and transcriptome changes of *Arabidopsis* during pathogen and insect attack. *Mol. Plant Micro. Inter.*, **18**: 923-937.
- Dharmasiri, N., Dharmasiri, S., and Estelle, M., 2005. The F-box protein TIR1 is an auxin receptor. *Nature*, **435**: 441-445.
- Dixon, R. A., and Paiva, N. L., 1995. Stress-induced phenylpropanoid metabolism. *Plant Cell*, **7**: 1085-1097.
- Dong, J. X., Chen, C. H., and Chen, Z. X., 2003. Expression profiles of the *Arabidopsis* WRKY gene superfamily during plant defense response. *Plant Mol. Biol.*, **51**: 21-37.
- Enyedi, A. J., Yalpani, N., Silverman, P., and Raskin, I., 1992. Localization, conjugation, and function of salicylic acid in tobacco during the hypersensitive reaction to tobacco mosaic virus. *Proc. Natl. Acad. Sci. USA.*, **89**: 2480-2484.
- Eulgem, T., 2005. Regulation of the *Arabidopsis* defense transcriptome. *Tren. Plant Sci.*, **10**: 71-78.
- Eulgem, T., Rushton, P. J., Robatzek, S., and Somssich, I. E., 2000. The WRKY superfamily of plant transcription factors. *Tren. Plant Sci.*, **5**: 199-206.
- Foyer, C. H., and Noctor, G., 2005. Oxidant and antioxidant signalling in plants: a re-evaluation of the concept of oxidative stress in a physiological context. *Plant Cell Environ.*, **28**: 1056-1071.
- Fraissinet-Tachet, L., Baltz, R., Chong, J., Kauffmann, S., Fritig, B., and Saindrenan, P., 1998. Two tobacco genes induced by infection, elicitor and salicylic acid encode glucosyltransferases acting on phenylpropanoids and benzoic acid derivatives, including salicylic acid. *FEBS Lett.*, **437**: 319-323.
- Frova, C., 2003. The plant glutathione transferase gene family: genomic structure, functions, expression and evolution. *Physiol. Plant.*, **119**: 469-479.
- Fujita, T., Kouchi, H., Ichikawa, T., and Syono, K., 1994. Cloning of cDNAs for genes that are specifically or preferentially expressed during the development of tobacco genetic tumors. *Plant J.*, **5**: 645-654.
- Gachon, C., Baltz, R., and Saindrenan, P., 2004. Over-expression of a scopoletin glucosyltransferase in *Nicotiana tabacum* leads to precocious lesion formation during the hypersensitive response to tobacco mosaic virus but does not affect virus resistance. *Plant Mol. Biol.*, **54**: 137-146.
- Galis, I., Šimek, P., Narisawa, T., Sasaki, M., Horiguchi, T., Fukuda, F., and Matsuoka, K., 2006. A novel R2R3 MYB transcription factor NtMYBJS1 is a methyl jasmonate-dependent regulator of phenylpropanoid-conjugate biosynthesis in tobacco. *Plant J. (In Press)*.
- Galis, I., Smith, J. L., and Jameson, P. E., 2004. Salicylic acid-, but not cytokinin-induced, resistance to WCIMV is associated with increased expression of SA-dependent resistance genes in *Phaseolus vulgaris*. *J. Plant Physiol.*, **161**: 459-466.

- Goda, H., Sawa, S., Asami, T., Fujioka, S., Shimada, Y., and Yoshida, S., 2004. Comprehensive comparison of auxin-regulated and brassinosteroid-regulated genes in *Arabidopsis*. *Plant Physiol.*, **134**: 1555-1573.
- Goda, H., Shimada, Y., Asami, T., Fujioka, S., and Yoshida, S., 2002. Microarray analysis of brassinosteroid-regulated genes in *Arabidopsis*. *Plant Physiol.*, **130**: 1319-1334.
- Goossens, A., Hakkinen, S. T., Laakso, I., Seppanen-Laakso, T., Biondi, S., De Sutter, V., Lammertyn, F., Nuutila, A. M., Soderlund, H., Zabeau, M., Inze, D., and Oksman-Caldentey, K. M., 2003. A functional genomics approach toward the understanding of secondary metabolism in plant cells. *Proc. Natl. Acad. Sci. USA.*, **100**: 8595-8600.
- Goy, P. A., Signer, H., Reist, R., Aichholz, R., Blum, W., Schmidt, E., and Kessmann, H., 1993. Accumulation of scopoletin is associated with the high disease resistance of the hybrid *Nicotiana-glutinosa* X *Nicotiana-debneyi*. *Planta*, **191**: 200-206.
- Gozzo, F., 2003. Systemic acquired resistance in crop protection: From nature to a chemical approach. *J. Agric. Food Chem.*, **51**: 4487-4503.
- Grace, S. C., and Logan, B. A., 2000. Energy dissipation and radical scavenging by the plant phenylpropanoid pathway. *Philos. Trans. R. Soc. Lond. Ser. B-Biol. Sci.*, **355**: 1499-1510.
- Kepinski, S. and Leyser, O., 2005. The *Arabidopsis* F-box protein TIR1 is an auxin receptor. *Nature*, **435**: 446-451.
- Kim, H. S., and Delaney, T. P., 2002. *Arabidopsis* SON1 is an F-box protein that regulates a novel induced defense response independent of both salicylic acid and systemic acquired resistance. *Plant Cell*, **14**: 1469-1482.
- Kubigsteltig, II., and Weiler, E. W., 2003. *Arabidopsis* mutants affected in the transcriptional control of allene oxide synthase, the enzyme catalyzing the entrance step in octadecanoid biosynthesis. *Planta*, **217**: 748-757.
- Leon, J., Rojo, E., and Sanchez-Serrano, J. J., 2001. Wound signalling in plants. *J. Exp. Bot.*, **52**: 1-9.
- Ludwikow, A., Gallois, P., and Sadowski, J., 2004. Ozone-induced oxidative stress response in *Arabidopsis*: Transcription profiling by microarray approach. *Cell. Mol. Biol. Lett.*, **9**: 829-842.
- Malamy, J., Carr, J. P., Klessig, D. F., and Raskin, I., 1990. Salicylic-acid - a likely endogenous signal in the resistance response of tobacco to viral-infection. *Science*, **250**: 1002-1004.
- Matsuoka, K., Demura, T., Galis, I., Horiguchi, T., Sasaki, M., Tashiro, G., and Fukuda, H., 2004. A comprehensive gene expression analysis toward the understanding of growth and differentiation of tobacco BY-2 cells. *Plant Cell Physiol.*, **45**: 1280-1289.
- Metraux, J. P., 2002. Recent breakthroughs in the study of salicylic acid biosynthesis. *Tren. Plant Sci.*, **7**: 332-334.
- Metraux, J. P., Signer, H., Ryals, J., Ward, E., Wyssbenz, M., Gaudin, J., Raschdorf, K., Schmid, E., Blum, W., and Inverardi, B., 1990. Increase in salicylic-acid at the onset of systemic acquired-resistance in cucumber. *Science*, **250**: 1004-1006.
- Mittler, R., 2002. Oxidative stress, antioxidants and stress tolerance. *Tren. Plant Sci.* **7**: 405-410.
- Nagata, T., Hasezawa, S., and Inze, D. 2004. Tobacco BY-2 cells: Biotechnology in Agriculture and Forestry, vol. 53, Springer-Verlag, Heidelberg, pp. 7-65.
- Ogawa, M., Hanada, A., Yamauchi, Y., Kuwahara, A., Kamiya, Y., and Yamaguchi, S., 2003. Gibberellin biosynthesis and response during *Arabidopsis* seed germination. *Plant Cell*, **15**: 1591-1604.
- Parani, M., Rudrabhatla, S., Myers, R., Weirich, H., Smith, B., Leaman, D. W., and Goldman, S. L., 2004. Microarray analysis of nitric oxide responsive transcripts in *Arabidopsis*. *Plant Biotech. J.*, **2**: 359-366.

- Pedley, K. F., and Martin, G. B., 2005. Role of mitogen-activated protein kinases in plant immunity. *Curr. Opin. Plant Biol.*, **8**: 541-547.
- Pieterse, C. M., and Van Loon, L., 2004. NPR1: the spider in the web of induced resistance signaling pathways. *Curr. Opin. Plant Biol.*, **7**: 456-464.
- Rashotte, A. M., Carson, S. D. B., To, J. P. C., and Kieber, J. J., 2003. Expression profiling of cytokinin action in *Arabidopsis*. *Plant Physiol.*, **132**: 1998-2011.
- Ryan, K. G., Swinny, E. E., Winefield, C., and Markham, K. R., 2001. Flavonoids and UV photoprotection in *Arabidopsis* mutants. *Z.Naturforsch.*, **56**: 745-754.
- Salzman, R. A., Brady, J. A., Finlayson, S. A., Buchanan, C. D., Sumner, E. J., Sun, F., Klein, P. E., Klein, R. R., Pratt, L. H., Cordonnier-Pratt, M. M., and Mullet, J. E., 2005. Transcriptional profiling of sorghum induced by methyl jasmonate, salicylic acid, and aminocyclopropane carboxylic acid reveals cooperative regulation and novel gene responses. *Plant Physiol.*, **138**: 352-368.
- Sappl, P. G., Onate-Sanchez, L., Singh, K. B., and Millar, A. H., 2004. Proteomic analysis of glutathione S-transferases of *Arabidopsis thaliana* reveals differential salicylic acid-induced expression of the plant-specific phi and tau classes. *Plant Mol. Biol.*, **54**: 205-219.
- Schenk, P. M., Kazan, K., Wilson, I., Anderson, J. P., Richmond, T., Somerville, S. C., and Manners, J. M., 2000. Coordinated plant defense responses in *Arabidopsis* revealed by microarray analysis. *Proc. Natl. Acad. Sci. USA.*, **97**: 11655-11660.
- Scholthof, K. B. G., 2004. Tobacco mosaic virus: A model system for plant biology. *Annu. Rev. Phytopath.*, **42**: 13-34.
- Seskar, M., Shulaev, V., and Raskin, I., 1998. Endogenous methyl salicylate in pathogen-inoculated tobacco plants. *Plant Physiol.*, **116**: 387-392.
- Singh, K. B., Foley, R. C., and Onate-Sanchez, L., 2002. Transcription factors in plant defense and stress responses. *Curr. Opin. Plant Biol.*, **5**: 430-436.
- Smart, C. M., Scofield, S. R., Bevan, M. W., and Dyer, T. A., 1991. Delayed leaf senescence in tobacco plants transformed with *tmr*, a gene for cytokinin production in *Agrobacterium*. *Plant Cell*, **3**: 647-656.
- Smigocki, A. C., 1991. Cytokinin content and tissue distribution in plants transformed by a reconstructed isopentenyl transferase gene. *Plant Mol. Biol.*, **16**: 105-115.
- Stein, M., and Somerville, S. C., 2002. MLO, a novel modulator of plant defenses and cell death, binds calmodulin. *Tren. Plant Sci.*, **7**: 379-380.
- Suzuki, H., Reddy, M. S. S., Naoumkina, M., Aziz, N., May, G. D., Huhman, D. V., Sumner, L. W., Blount, J. W., Mendes, P., and Dixon, R. A., 2005. Methyl jasmonate and yeast elicitor induce differential transcriptional and metabolic re-programming in cell suspension cultures of the model legume *Medicago truncatula*. *Planta*, **220**: 696-707.
- Swiatek, A., Lenjou, M., Van Bockstaele, D., Inze, D., and Van Onckelen, H., 2002. Differential effect of jasmonic acid and abscisic acid on cell cycle progression in tobacco BY-2 cells. *Plant Physiol.*, **128**: 201-211.
- Takahashi, S., Seki, M., Ishida, J., Satou, M., Sakurai, T., Narusaka, M., Kamiya, A., Nakajima, M., Enju, A., Akiyama, K., Yamaguchi-Shinozaki, K., and Shinozaki, K., 2004. Monitoring the expression profiles of genes induced by hyperosmotic, high salinity, and oxidative stress and abscisic acid treatment in *Arabidopsis* cell culture using a full-length cDNA microarray. *Plant Mol. Biol.*, **56**: 29-55.
- Tamaoki, M., Nakajima, N., Kubo, A., Aono, M., Matsuyama, T., and Saji, H., 2003. Transcriptome analysis of O-3-exposed *Arabidopsis* reveals that multiple signal pathways act mutually antagonistically to induce gene expression. *Plant Mol. Biol.*, **53**: 443-456.
- Thatcher, L. F., Anderson, J. P., and Singh, K. B., 2005. Plant defence responses: what have we learnt from *Arabidopsis*? *Funct. Plant Biol.*, **32**: 1-19.

- Thomann, A., Dieterle, M., and Genschik, P., 2005. Plant CULLIN-based E3s: Phytohormones come first. *FEBS Lett.*, **579**: 3239-3245.
- Uknes, S., Dincher, S., Friedrich, L., Negrotto, D., Williams, S., Thompson-taylor, H., Potter, S., Ward, E., and Ryals, J., 1993. Regulation of pathogenesis-related protein-1a gene-expression in tobacco. *Plant Cell*, **5**: 159-169.
- Van Zhong, G., and Burns, J. K., 2003. Profiling ethylene-regulated gene expression in *Arabidopsis thaliana* by microarray analysis. *Plant Mol. Biol.*, **53**: 117-131.
- Veronese, P., Ruiz, M. T., Coca, M. A., Hernandez-Lopez, A., Lee, H., Ibeas, J. I., Damsz, B., Pardo, J. M., Hasegawa, P. M., Bressan, R. A., and Narasimhan, M. L., 2003. In defense against pathogens. Both plant sentinels and foot soldiers need to know the enemy. *Plant Physiol.*, **131**: 1580-1590.
- Wiermer, M., Feys, B. J., and Parker, J. E., 2005. Plant immunity: the EDS1 regulatory node. *Curr. Opin. Plant Biol.*, **8**: 383-389.
- Yalpani, N., Silverman, P., Wilson, T. M. A., Kleier, D. A., and Raskin, I., 1991. Salicylic acid is a systemic signal and an inducer of pathogenesis-related proteins in virus-infected tobacco. *Plant Cell*, **3**: 809-818.
- Yang, K. Y., Liu, Y. D., and Zhang, S. Q., 2001. Activation of a mitogen-activated protein kinase pathway is involved in disease resistance in tobacco. *PNAS*, **98**: 741-746.
- Yang, Y. N., Qi, M., and Mei, C. S., 2004. Endogenous salicylic acid protects rice plants from oxidative damage caused by aging as well as biotic and abiotic stress. *Plant J.*, **40**: 909-919.
- Yazaki, J., Shimatani, Z., Hashimoto, A., Nagata, Y., Fujii, F., Kojima, K., Suzuki, K., Taya, T., Tonouchi, M., Nelson, C., Nakagawa, A., Otomo, Y., Murakami, K., Matsubara, K., Kawai, J., Carninci, P., Hayashizaki, Y., and Kikuchi, S., 2004. Transcriptional profiling of genes responsive to abscisic acid and gibberellin in rice: phenotyping and comparative analysis between rice and *Arabidopsis*. *Physiol. Genom.*, **17**: 87-100.
- Yazaki, K., 2005. Transporters of secondary metabolites. *Curr. Opin. Plant Biol.*, **8**: 301-307.
- Zhang, S. Q., and Klessig, D. F., 1997. Salicylic acid activates a 48-kD MAP kinase in tobacco. *Plant Cell*, **9**: 809-824.
- Zhang, S. Q., and Liu, Y. D., 2001. Activation of salicylic acid-induced protein kinase, a mitogen-activated protein kinase, induces multiple defense responses in tobacco. *Plant Cell*, **13**: 1877-1889.

Index

- ABC transporters, 382
Abiotic stress, 91, 94, 95, 100,
110, 112, 114, 115, 117, 119,
121, 122, 123, 124, 125, 128,
131, 132, 133, 134, 135, 137,
138, 140, 142, 144, 145, 149
Abiotic stresses, 151, 153, 156,
157, 158
Abscisic acid, 22, 23, 277,
297, 317
Acetylsalicylic acid, 164
Activation sequence-1, 277, 305
Alkaloid biosynthesis, 381
Alternative oxidase, 93, 107, 126,
127, 138, 139, 141
Antioxidant activity, 141
Antioxidant, 70, 79, 80, 82, 83,
84, 85, 86, 87, 88
Arabidopsis thaliana, 30, 50, 62,
64, 67
Arabidopsis, 372, 373, 374, 376,
377, 379, 380, 382, 383, 384,
387, 388, 390, 391, 392, 393,
394, 395, 396
as-1, 198, 211, 215, 216, 217,
218, 233, 234, 235, 238, 242,
243, 244, 246
Ascorbate peroxidase, 186, 187
Aspirin, 16

BAP, 167, 168, 169, 170, 171,
172, 189
Beans, 16
Beet, 20
Benzenoid carboxyl
methyltransferase, 277, 286,
312, 317
Benzoic acid 2-hydroxylase, 277,
283, 315
Benzoic acid, 92, 137, 141, 147
Biomass, 18
Bioproductivity, 15, 16, 20,
22, 23
Biosynthesis, 1,2, 4,11, 12, 13, 14
Bradyrhizobium japonicum, 153,
154, 155, 160
Brassica juncea, 5, 6, 9, 12

Calcium, 277, 279, 295, 296, 297,
308, 309, 310, 313, 314, 315,
316, 317, 318, 319, 320
Calcium-dependent protein
kinase, 277
Callose synthesis, 48, 49, 50, 53,
58, 59
Callose, 25, 47, 48, 49, 50, 51, 52,
53, 56, 57, 58, 59, 62, 63, 64,
65, 66, 67
Calmodulin, 277, 295, 312, 313,
317, 320
Carbonic anhydrase, 7
Carica papaya, 20, 21, 22, 23
Catalase, 101, 102, 103, 105, 106,
114, 122, 123, 137, 138, 140,
146, 163, 175, 177, 178, 179,
180, 181, 186, 187, 190,
191, 193
CCC, 166, 167, 168, 169, 171
Chlorophyll, 1, 5, 6, 12, 13
Clitoria, 18, 23
Cold, 98, 100, 104, 106, 107, 110,
116, 117, 118, 120, 121, 126,
127, 130, 131, 133, 135, 137,
140, 141, 142, 146, 147,
148, 149
Commelina, 16
Cross talk, 335, 354, 363
Cucumber, 22

- Cytochrome P450, 380, 381, 384
- Defence, 323, 326, 332, 334
- Density, 15, 16
- Dihydroxybenzoic acid, 277, 279
- Diphenyleiodonium, 277
- Drought, 15, 22, 23, 97, 98, 99, 106, 109, 110, 115, 116, 117, 118, 119, 120, 121, 129, 132, 134, 137, 140, 141, 145, 146, 147
- Electron spin resonance, 277, 291, 293
- Elicitor treatment, 28, 29, 30
- Engineering disease resistance, 335, 357
- Erwinia carotovora*, 247, 273
- Ethylene, 1, 9, 13, 14, 247, 250, 251, 262, 263, 266, 269, 270, 271, 272, 273, 275, 276, 302, 312, 315, 318, 373, 374, 383, 386, 389, 390, 393, 396
- Explants, 164, 166, 167, 168, 169, 170, 171, 173, 174, 175, 176, 177, 178, 179, 180, 181
- Flowering, 5, 10, 11, 12, 13, 14, 15, 19, 20, 23
- Freezing tolerance, 163, 185, 186, 193, 195
- Freezing, 104, 107, 126, 134, 147, 148, 163, 185, 186, 187, 193, 195
- Gene expression, 277, 284, 287, 293, 301, 303, 304, 305, 309, 310, 311, 318
- Germplasm preservation, 163, 164, 190
- Germplasm storage, 165, 171, 190
- Gloxinia*, 18, 20, 23
- Glucosyltransferase, 378, 381, 383, 385, 386, 393
- Glutathione-S-transferase, 380
- Heat, 93, 100, 101, 102, 103, 106, 107, 114, 115, 116, 118, 119, 126, 134, 137, 138, 140, 143, 144, 146, 149
- Hormonal balance, 71, 76, 85
- Horseradish peroxidase, 277, 294, 313, 314, 315
- Hypersensitive response, 277, 300
- Indolacetic acid, 16
- Ion transport, 25, 26, 27, 30, 31, 35, 37, 41, 42, 56, 59
- Isochorismate pyruvate-lyase, 277, 283
- Isochorismate synthase, 277, 283, 319, 320
- Jasmonic acid, 247, 250, 261, 265, 269, 270, 277, 303, 312, 317, 373, 374, 382, 383, 390, 391, 395
- Late blight, 163, 164, 188, 189
- Legumes, 152, 155, 159
- Lemna*, 19
- Lignin, 381
- Maintenance, 171
- Meristem, 182, 191
- Metabolism, 1, 3, 12
- Methyl jasmonate, 372, 374, 375, 377, 381, 393, 395
- Methyl salicylate, 278, 281, 313, 319
- Microarray analysis, 371, 373, 374, 392, 393, 394, 395, 396
- Microarrays, 198, 222
- Microplants, 163, 164, 165, 166, 168, 169, 171, 172, 173, 175,

- 176, 177, 178, 179, 180, 181,
182, 183, 184, 189, 192, 193
- Mineral nutrients, 9
- Mitochondrial membranes, 25,
37, 39, 40
- Mitogen-activated protein kinase,
277, 300, 313, 314, 320, 321
- NahG, 94, 102, 103, 108, 109,
112, 135, 148
- Nitrate metabolism, 8
- Nitrate reductase, 8, 12, 13
- Nitric oxide, 247, 263, 265, 266,
267, 268, 269, 274
- Nitrogen fixation, 155
- Nodulation, 151, 155, 160,
161, 162
- NPR1, 198, 210, 212, 213, 214,
215, 216, 217, 218, 219, 220,
221, 223, 227, 233, 234, 235,
236, 237, 238, 239, 240, 241,
242, 243, 245, 246
- Oxalate oxidase, 323, 332, 334
- Oxidative burst, 379
- Ozone, 91, 111, 112, 113, 114,
125, 131, 132, 136, 137, 138,
139, 141, 144, 145, 146,
147, 149
- Papaya, 20, 22
- Pathogen interactions, 255, 269
- Pathogen resistance, 335,
359, 367
- Pathogen transport, 25, 48
- Pathogenesis, 25, 28, 33, 34, 41,
55, 59, 60, 61, 65, 67
- Pathogenesis-related, 335, 338,
359, 365, 367, 369
- PCD events, 253, 256, 257, 259,
262, 264
- Phaseolus lunatus*, 30
- Phaseolus vulgaris*, 6, 13
- Phenylalanine ammonia-lyase
(PAL), 381
- Phenylalanine ammonia-lyase,
277, 283, 316
- Phenylpropanoid pathway, 380,
385, 394
- Photosynthetic rate, 1, 7, 12
- Phytoalexin synthesis, 34, 41, 58
- Plant defense, 277, 278, 279, 284,
286, 290, 295, 296, 306, 312,
314, 317, 318, 320, 335, 336,
337, 338, 340, 341, 343, 344,
346, 347, 354, 355, 356, 358,
361, 364, 366, 367, 368, 369
- Plant growth, 1, 4, 5, 11
- Plant isoperoxidase, 327
- Plant-pathogen interactions, 248,
249, 250, 253, 255, 256,
258, 262
- Plasma membrane, 25, 26, 27, 28,
29, 30, 31, 32, 35, 36, 37, 42,
48, 52, 53, 54, 55, 56, 57, 60,
61, 62, 63, 64, 65, 66, 68
- Plasmodesmata, 25, 41, 42, 43,
44, 45, 46, 47, 48, 49, 51, 53,
54, 55, 56, 57, 58, 60, 61, 63,
64, 67
- Productivity, 16, 19
- Programmed cell death, 247, 252,
253, 263, 264, 265, 266, 268,
269, 270, 271, 272, 273, 274,
275, 276, 300
- Proline, 158, 159, 160, 161, 162
- Proteasome, 390
- Protein kinases, 387, 388,
389, 395
- Radish, 20
- Reactive oxygen intermediates,
324, 332, 379

- Reactive oxygen species, 26, 35, 55, 56, 57, 63, 66, 94, 141, 247, 248, 249, 250, 253, 254, 255, 256, 264, 265, 269, 270, 277, 278, 279, 311, 314, 315, 316, 317
- Regulatory genes, 383, 388, 389
- Resistance to salinity, 80
- Rhizobium leguminosarum*, 154, 155
- Rhizobium meliloti*, 154, 155, 161
- Rhizobium*, 151, 152, 154, 155, 159, 161
- Root, 15, 16, 17, 20, 22, 23
- Rooting, 16, 22
- ROS, 26, 35, 36, 37, 38, 42, 53, 79, 80, 81, 82, 83, 84, 85, 86, 197, 198, 199, 200, 201, 202, 203, 204, 205, 206, 207, 208, 209, 210, 219, 223, 226, 232, 233, 234, 236, 247, 248, 249, 250, 251, 253, 254, 255, 256, 257, 260, 261, 262, 263, 264, 265, 270
- Salicylates, 163, 164, 170, 174, 190
- Salicylhydroxamic acid, 280
- salicylic acid, 1, 2, 3, 4, 5, 6, 7, 8, 9, 10, 11, 12, 13, 14, 15, 16, 17, 18, 19, 20, 21, 22, 23, 25, 35, 37, 41, 42, 43, 46, 48, 51, 54, 55, 56, 57, 58, 59, 60, 61, 62, 63, 64, 65, 66, 67, 68, 69, 70, 71, 72, 85, 86, 87, 88, 151, 153, 155, 156, 157, 159, 160, 161, 162, 163, 164, 185, 186, 187, 188, 190, 191, 192, 193, 194, 195, 197, 198, 207, 235, 236, 237, 238, 239, 240, 241, 242, 243, 244, 245, 246, 247, 248, 249, 250, 258, 260, 265, 266, 267, 268, 269, 270, 271, 272, 273, 274, 275, 276, 277, 278, 281, 286, 303, 311, 312, 313, 314, 315, 316, 317, 318, 319, 320, 321, 371, 372, 374, 378, 383, 386, 392, 393, 394, 395, 396
- Salinity, 108, 109, 115, 116, 117, 118, 121, 134, 139, 140, 147, 148
- Secondary roots, 16
- Shoot growth, 18
- Signal transduction pathway, 198, 226, 233
- Signal transduction, 277, 279, 287, 291, 296, 303, 306, 307, 308, 311, 312, 315, 320
- Signalling, 270, 319
- Soil, 16
- Sorghum, 374, 376, 379, 380, 381, 382, 383, 384, 387, 388, 390, 392, 393, 395
- Soybean, 16, 23
- β -1,3-glucanase activity, 51, 52, 59
- Stolons, 164, 165, 174
- Stress defense genes, 197, 198, 203, 204, 207, 217, 221, 223, 232
- Symbiosis, 151, 153, 154, 155, 161
- Systemic acquired resistance, 278, 283, 311, 312, 313, 314, 315, 316, 319, 320, 321, 335, 338, 353, 359, 360, 361, 362, 363, 364, 365, 366, 367, 368, 369, 370
- Tagetes erecta*, 17, 18, 19, 23
- TGA, 198, 210, 212, 213, 214, 215, 216, 217, 218, 219, 220,

- 221, 224, 228, 233, 234, 235,
237, 238, 239, 240, 242, 243,
244, 246
- Thermotherapy, 163, 164, 175,
181, 182, 183, 184, 193
- Thermotolerance, 163, 175, 177,
178, 180, 181, 182, 184, 190,
191, 192
- Tobacco BY-2 cells, 371, 375,
388, 392, 394, 395
- Tobacco mosaic virus, 278, 279,
312, 316, 318, 320
- Tobacco necrosis virus, 278, 283,
287, 317
- Tomato, 20
- Transcription factors, 387, 388,
389, 390, 393, 395
- Transcriptome, 372, 373,
393, 395
- Trichoderma viride*, 30
- Tuberization, 163, 164, 165, 166,
167, 168, 169, 170, 171, 189,
190, 192, 194, 195
- UV, 91, 103, 113, 114, 117, 119,
121, 128, 129, 130
- Vigna mungo*, 5, 8, 11
- Violet, 18, 20, 23
- Virulence factors, 41, 64
- Virus-eradication, 182
- Virus-free, 164, 175, 182,
184, 191
- Wheat seedlings, 70, 71, 72, 73,
75, 76, 77, 78, 79, 81, 82, 83,
84, 85, 86, 88
- Wounding-induced protein
kinase, 280, 303
- Yield, 15, 16, 20, 21