

THE  
**MUSHROOM**  
CULTIVATOR



**A PRACTICAL GUIDE TO  
GROWING MUSHROOMS AT HOME  
BY PAUL STAMETS AND J.S. CHILTON**

---

# TABLE OF CONTENTS

<b>FOREWORD</b> by Dr. Andrew Weil . . . . .	<b>.xi</b>
<b>PREFACE</b> . . . . .	<b>xii</b>
<b>I. INTRODUCTION TO MUSHROOM CULTURE</b> . . . . .	<b>1</b>
An <i>Overview</i> of Techniques for Mushroom Cultivation . . . . .	3
Mushrooms and Mushroom Culture . . . . .	4
The Mushroom Life Cycle . . . . .	6
<b>II. STERILE TECHNIQUE AND AGAR CULTURE</b> . . . . .	<b>15</b>
Design and Construction of a Sterile Laboratory . . . . .	16
Preparation of Agar Media . . . . .	19
Starting A Culture from Spores . . . . .	23
Taking a Spore Print . . . . .	23
Techniques for Spore Germination . . . . .	24
Characteristics of the Mushroom Mycelium . . . . .	25
Ramifications of Multispore Culture . . . . .	25
Sectoring: Strain Selection and <i>Development</i> . . . . .	31
Stock Cultures: Methods For Preserving Mushroom Strains . . . . .	37
<b>III. GRAIN CULTURE</b> . . . . .	<b>41</b>
The Development of Grain Spawn . . . . .	42
Preparation of Grain Spawn . . . . .	45
Spawn Formulas . . . . .	46
Inoculation of <i>Sterilized</i> Grain from Agar Media . . . . .	48
Inoculation of Sterilized Grain from Grain Masters . . . . .	49
Alternative Spawn Media . . . . .	54
Liquid Inoculation Techniques . . . . .	55
Incubation of Spawn . . . . .	57
<b>IV. THE MUSHROOM GROWING ROOM</b> . . . . .	<b>61</b>
Structure and Growing Systems . . . . .	62
Structure . . . . .	63
Shelves . . . . .	64
Trays . . . . .	65
Environmental Control Systems . . . . .	66
Fresh Air . . . . .	66
Fans . . . . .	68
Air Ducting . . . . .	70
Filters . . . . .	70
Exhaust Vents . . . . .	72
Heating . . . . .	73

---

Cooling . . . . .	73
Humidification . . . . .	74
Thermostats and Humidistats . . . . .	74
Lighting . . . . .	74
Environmental Monitoring Equipment . . . . .	76
<b>V. COMPOST PREPARATION . . . . .</b>	<b>77</b>
Phase I Composting . . . . .	78
Basic Raw Materials . . . . .	78
Supplements . . . . .	79
Formulas . . . . .	81
Ammonia . . . . .	82
Carbon:Nitrogen Ratio . . . . .	83
Water:Air . . . . .	83
Pre-Wetting . . . . .	84
Building the Pile . . . . .	85
Turning . . . . .	87
Temperature . . . . .	88
Long Composting . . . . .	89
Short Composting . . . . .	90
Synthetic Compost Procedure . . . . .	91
Composting Tools . . . . .	92
Characteristics of the Compost at Filling . . . . .	93
Supplementation at Filling . . . . .	95
Phase II Composting . . . . .	96
Basic Air Requirements . . . . .	97
Phase II Room Design . . . . .	98
Filling Procedures . . . . .	98
Depth of Fill . . . . .	99
Phase II Procedures: Trays or Shelves . . . . .	100
Phase II in Bulk . . . . .	101
Bulk Room Design Features . . . . .	102
Bulk Room Filling Procedures . . . . .	104
Bulk Room Phase II Program . . . . .	104
Testing for Ammonia . . . . .	104
Aspect of the Finished Compost . . . . .	105
Alternative Composts and Composting Procedures . . . . .	106
Sugar Cane Bagasse Compost . . . . .	106
The Five Day Express Composting Method . . . . .	106
<b>VI. NON-COMPOSTED SUBSTRATES . . . . .</b>	<b>109</b>
Natural Culture . . . . .	110
Wood Based Substrates . . . . .	114

Straw . . . . .	117
<b>VII. SPAWNING AND SPAWN RUNNING IN BULK SUBSTRATES. . . . .</b>	<b>121</b>
Moisture Content . . . . .	122
Substrate Temperature . . . . .	122
Dry Weight of Substrate . . . . .	122
Duration of Spawn Run . . . . .	124
Spawning Methods . . . . .	124
Environmental Conditions . . . . .	125
Super Spawning . . . . .	126
Supplementation at Spawning . . . . .	126
Supplementation at Casing . . . . .	126
<b>VIII. THE CASING LAYER. . . . .</b>	<b>127</b>
Function . . . . .	128
Properties . . . . .	129
Materials . . . . .	130
Formulas and Preparation . . . . .	132
Application . . . . .	133
Casing Colonization . . . . .	135
Casing Moisture and Mycelial Appearance . . . . .	137
<b>IX. STRATEGIES FOR MUSHROOM FORMATION (PINHEAD INITIATION) . . . . .</b>	<b>139</b>
Basic Pinning Strategy . . . . .	140
Primordia Formation Procedures . . . . .	141
The Relationship Between Primordia Formation and Yield . . . . .	146
The Influence of Light on Pinhead Initiation . . . . .	147
<b>X. ENVIRONMENTAL FACTORS: SUSTAINING THE MUSHROOM CROP. . . . .</b>	<b>149</b>
Temperature . . . . .	150
Flushing Pattern . . . . .	150
Air Movement . . . . .	152
Watering . . . . .	154
Harvesting . . . . .	155
Preserving Mushrooms . . . . .	156
<b>XI. GROWING PARAMETERS FOR VARIOUS MUSHROOM SPECIES. . . . .</b>	<b>159</b>
<i>Agaricus bitorquis</i> . . . . .	161
<i>Agaricus brunnescens</i> . . . . .	164
<i>Coprinus comatus</i> . . . . .	168
<i>Flammulina velutipes</i> . . . . .	172
<i>Lentinus edodes</i> . . . . .	176
<i>Lepista nuda</i> . . . . .	180
<i>Panaeolus cyanescens</i> . . . . .	183
<i>Panaeolus subbalteatus</i> . . . . .	186

Pleurotus ostreatus (Type Variety) . . . . .	189
Pleurotus ostreatus (Florida Variety) . . . . .	193
Psilocybe cubensis . . . . .	196
Psilocybe cyanescens . . . . .	200
Psilocybe mexicana . . . . .	204
Psilocybe tampanensis . . . . .	207
Stropharia rugoso-annulata . . . . .	210
Volvariella volvacea . . . . .	214

## **XII. CULTIVATION PROBLEMS AND THEIR SOLUTIONS:**

<b>A TROUBLE SHOOTING GUIDE . . . . .</b>	<b>217</b>
Sterile Technique . . . . .	219
Agar Culture . . . . .	219
Grain Culture . . . . .	220
Compost Preparation . . . . .	223
Phase I . . . . .	223
Phase II . . . . .	224
Spawn Running . . . . .	226
Case Running . . . . .	227
Mushroom Formation and Development . . . . .	229
Pinhead Initiation . . . . .	229
Cropping . . . . .	231

## **XIII. THE CONTAMINANTS OF MUSHROOM CULTURE:**

<b>IDENTIFICATION AND CONTROL . . . . .</b>	<b>233</b>
A Key to the Common Contaminants of Mushroom Culture . . . . .	238
Virus (Die-Back Disease) . . . . .	244
Actinomyces (Firefang) . . . . .	246
Bacillus (Wet Spot) . . . . .	248
Pseudomonas (Bacterial Blotch & Pit) . . . . .	252
Streptomyces (Firefang) . . . . .	255
Alternaria (Black Mold) . . . . .	257
Aspergillus (Green Mold) . . . . .	259
Botrytis (Brown Mold) . . . . .	262
Chaetomium (Olive Green Mold) . . . . .	264
Chrysosporium (Yellow Mold) . . . . .	266
Cladosporium (Dark Green Mold) . . . . .	268
Coprinus (Inky Cap) . . . . .	270
Cryptococcus (Cream Colored Yeast) . . . . .	273
Dactylium (Cobweb Mold) . . . . .	275
Doratomyces (Black Whisker Mold) . . . . .	277
Epicoccum (Yellow Mold) . . . . .	279

Fusarium (Pink Mold) . . . . .	281
Geotrichum (Lipstick Mold). . . . .	284
Humicola (Gray Mold). . . . .	286
Monilia (White Flour Mold). . . . .	288
Mucor (Black Pin Mold). . . . .	290
Mycelia Sterilia (White Mold). . . . .	292
Mycogone (Wet Bubble). . . . .	294
Neurospora (Pink Mold). . . . .	296
Papulospora (Brown Plaster Mold). . . . .	298
Penicillium (Bluish Green Mold). . . . .	300
Rhizopus (Black Pin Mold). . . . .	302
Scopulariopsis (White Plaster Mold). . . . .	304
Sepedonium (White or Yellow Mold). . . . .	306
Torula (Black Yeast). . . . .	308
Trichoderma (Forest Green Mold). . . . .	310
Trichothecium (Pink Mold). . . . .	313
Verticillium (Dry Bubble). . . . .	315
XIV. THE PESTS OF MUSHROOM CULTURE. . . . .	319
Mushroom <i>Flies</i> . . . . .	320
Fly Control Measures. . . . .	320
Sciarid Fly. . . . .	321
Phorid Fly. . . . .	323
Cecid Fly. . . . .	325
Mites. . . . .	328
Nematodes (Eelworms). . . . .	331
XV. MUSHROOM GENETICS. . . . .	333
Reproductive Strategies. . . . .	336
Implications for Culture Work. . . . .	338
APPENDICES . . . . .	343
I. Medicinal Properties of Mushrooms. . . . .	345
II. Laminar Flow Systems. . . . .	347
III. The Effect of <i>Bacteria</i> and Other Microorganisms on Fruiting. . . . .	253
IV. The Use of Mushroom <i>Extracts</i> to Induce Fruiting. . . . .	357
V. Data Collection and Environmental Monitoring Records. . . . .	359
VI. Analyses of Basic Materials Used in <i>Substrate</i> Preparation. . . . .	369
VII. Resources For Mushroom Growing Equipment and Supplies. . . . .	384
VIII. English to Metric Conversion Tables. . . . .	386
GLOSSARY. . . . .	389
BIBLIOGRAPHY . . . . .	397

---

<b>INDEX</b> .....	<b>409</b>
PHOTOGRAPHY AND ILLUSTRATION CREDITS.....	414
ACKNOWLEDGEMENTS.....	415

---

---

# FOREWORD

Ever since French growers pioneered the cultivation of the common *Agaricus* more than two hundred years ago, mushroom cultivation in the Western world has been a mysterious art. Professional cultivators, fearful of competition, have guarded their techniques as trade secrets, sharing them only with closest associates, never with amateurs. The difficulty of domesticating mushrooms adds to the mystery: they are just harder to grow than flowering plants. Some species refuse to grow at all under artificial conditions; many more refuse to fruit; and even the familiar *Agaricus* of supermarkets demands a level of care and attention to detail much beyond the scope of ordinary gardening and agriculture.

In the past ten years, interest in mushrooms has literally mushroomed in America. For the first time in history the English-speaking world is flooded with good field guides to the higher fungi, and significant numbers of people are learning to collect and eat choice wild species. In the United States and Canada mushroom conferences and forays attract more and more participants. Cultivated forms of species other than the common *Agaricus* have begun to appear in specialty shops and even supermarkets.

The reasons for this dramatic change in a traditionally mycophobic part of the world may never be known. I have been fascinated with mushrooms as symbols of the unconscious mind and think their growing popularity here is a hopeful sign of progress in the revolution of consciousness that began in the 1960s. A more specific reason may be the rediscovery of psychedelic mushrooms—the *Psilocybes* and their allies—which have thoroughly invaded American society in recent years.

The possibility of collecting wild psychoactive mushrooms in many parts of North America has motivated thousands of people to buy field guides and attend mushroom conferences. The possibility of growing *Psilocybe cubensis* at home, one of the easier species to cultivate, has made many people eager to learn the art of mushroom production. As they pursue their hobby, fans of *Psilocybes* often find their interest in mushrooms broadening to include other genera that boast nonpsychoactive but delicious edible species. Other mycophiles, uninterested in altered states of consciousness, have grown so fond of some edible species as to want better access to them than foraging in the wild provides. The result has been a demand from a variety of amateurs for the trade secrets of professional cultivators.

The book you are about to read is a milestone in the new awareness of mushrooms. THE MUSHROOM CULTIVATOR by Paul Stamets and Jeff Chilton is easily the best source of information on growing mushrooms at home. Both authors are experts on the higher fungi, on their technical aspects as well as the practical methods of working with the most interesting species. Paul Stamets is a recognized authority on the *Psilocybes* and their relatives; Jeff Chilton has been a professional consultant to large-scale, commercial producers of the common *Agaricus* and the once-exotic shiitake of Japan and China. Together they have organized a number of successful mushroom conferences in the Pacific Northwest and have championed the cause of growing at home.

---



Unlike experts of the past (and some of the present), they are willing and ready to share their knowledge and practical information with all lovers of mushrooms, whether they are amateurs or professionals, devotees of *Psilocybe* or of *Pleurotus*.

THE MUSHROOM CULTIVATOR is indeed "A Practical Guide to Growing Mushrooms at Home," as its subtitle indicates. It covers every aspect of the subject in a readable style and in sufficient detail to enable both rank amateurs and serious mycologists to succeed at growing the mushrooms they like. By including a wealth of excellent illustrations, information on obtaining equipment and supplies, and step-by-step directions for every procedure, from starting spore cultures to harvesting fruiting bodies to dealing with contaminants and pests, the authors demystify the art of mushroom cultivation and put mastery of it within everyone's reach. It is a pleasure to introduce this fine book. If you have been searching for information on this topic, you will find it to be all that you have been looking for and more.

Andrew Weil, M.D., F.L.S.

---

---

# PREFACE

The use of mushrooms as food crosses all cultural boundaries. Highly prized by the Greeks, mushroom consumption in European nations has deep traditional roots. The Agari, a pre-Scythian people from Samartia (now Poland and the western Soviet Union), held mushrooms in high esteem and used them medicinally. The early Greeks held a similar fascination for fungi and apparently worked them into their religious rituals, even to the extent that to discuss the use of these sacraments violated strong taboos. For thousands of years, the Chinese and Japanese have prized a variety of mushroom species for their beneficial properties. In the New World, the Aztec and Mazatec Indians of Mexico used mushrooms for both their healing and divining properties. Clearly, mushrooms have played a significant role in the course of human cultures worldwide.

Although the Japanese have cultivated the Shiitake mushroom for two thousand years, the earliest record of European mushroom cultivation was in the 17th century when an agronomist to Louis XIV, Olivier de Serres, retrieved wild specimens and implanted mushroom mycelium in prepared substrates. In those times mushroom growing was a small scale outdoor activity practiced by the rural populace. Materials in which mushrooms grew naturally were collected and concentrated into prepared beds. These beds were cropped and then used to start new beds. As demand increased and new methods improved yields, mushroom growing developed into a large scale commercial business complete with computer controlled indoor environments and scientifically formulated substrates. Spawn with which to plant prepared beds, initially gathered in nature, became standardized as sterile culture techniques were perfected.

It is now known that many of the mushrooms presently under cultivation rank above all vegetable and legumes (except soybeans) in protein content, and have significant levels of B and C vitamins and are low in fat. Research has shown that certain cultivated mushrooms reduce serum cholesterol, inhibit tumors, stimulate interferon production and possess antiviral properties. It is no surprise, therefore, that as food plants were developed into cultivars, mushrooms were among those selected.

Discovering the methods most successful for mushroom cultivation has been a long and arduous task, evolving from the experience of lifetimes of research. As mushroom growing expanded from the realm of home cultivators to that of a multimillion dollar industry, it is not surprising that growers became more secretive about their methods. For prospective home cultivators, finding appropriate information has become increasingly difficult. As a result, the number of small growers decreased and home cultivation became a rare enterprise.

The Mushroom Cultivator is written expressly for the home cultivator and is without bias against any group of interested growers. For the first time, information previously unavailable to the general public is presented in a clear and easy to understand fashion. The book reflects not only the work of the authors but also the cumulative knowledge gained through countless

---

trials by mushroom growers and researchers. It is the sincere hope of the authors that this work will re-open the door to the fascinating world of mushroom culture. The Mushroom Cultivator is dedicated to this goal as we pursue the Art and Science of mushroom cultivation.

*[The remainder of the page contains extremely faint, illegible text, likely bleed-through from the reverse side of the page.]*

---

# CHAPTER I

## INTRODUCTION TO MUSHROOM CULTURE



Figure 0 Wall of *Pleurotus ostreatus* fruitbodies.

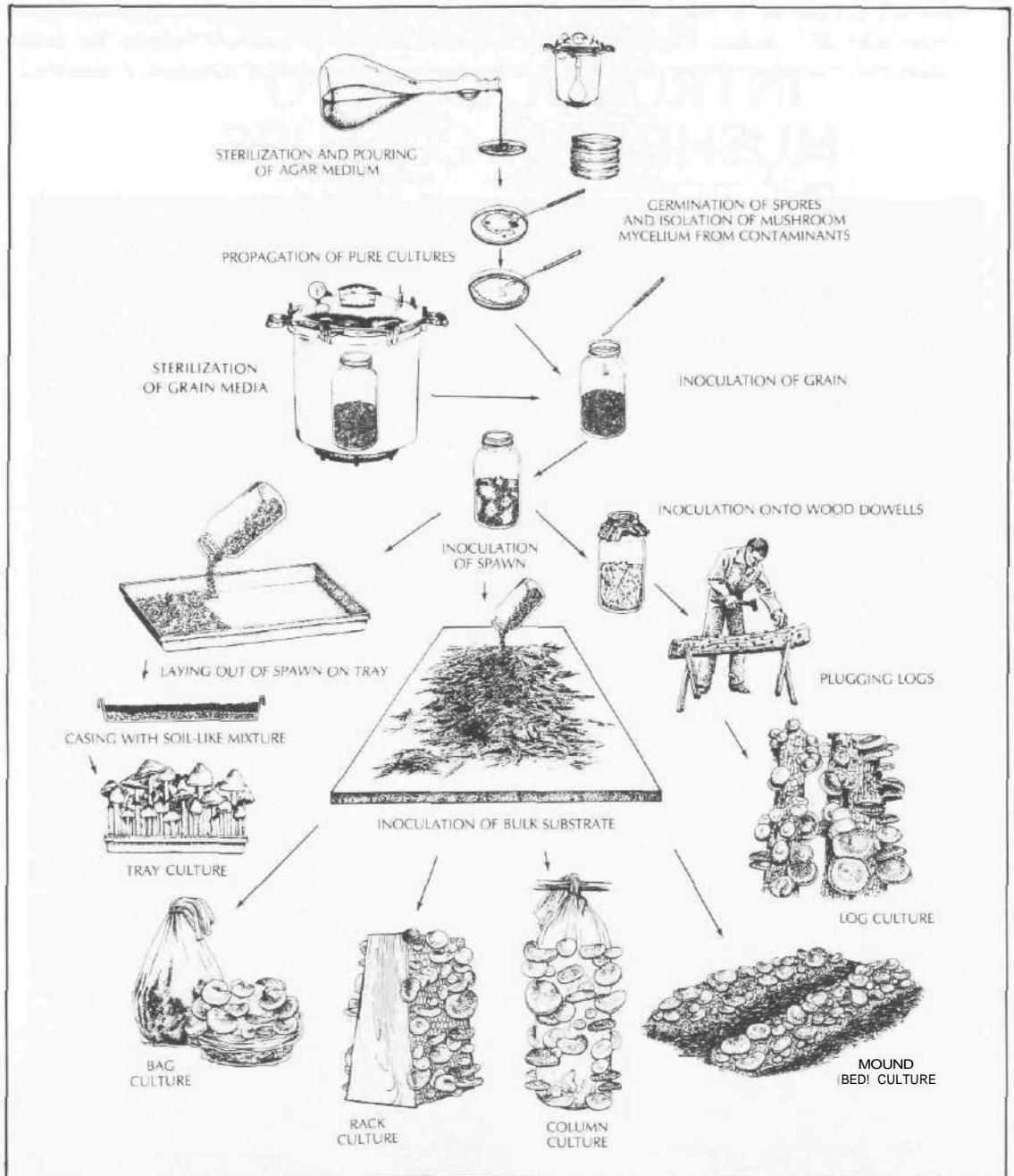

Figure 1 Diagram illustrating overview of general techniques for the cultivation of mushrooms.

## AN OVERVIEW OF TECHNIQUES FOR MUSHROOM CULTIVATION

**T**echniques for cultivating mushrooms, *whatever* the species, follow the same basic pattern. Whereas two species may differ in temperature requirements, pH preferences or the substrate on which they grow, the steps leading to fruiting are essentially the same. They can be summarized as follows:

1. Preparation and pouring of agar media into petri dishes.
2. Germination of spores and isolation of pure mushroom mycelium.
3. Expansion of mycelial mass on agar media.
4. Preparation of grain media.
5. Inoculation of grain media with pure mycelium grown on agar media.
6. Incubation of inoculated grain media (spawn).
7. A. Laying out grain spawn onto trays.  
or  
B. Inoculation of grain spawn into bulk substrates.
8. Casing—covering of substrate with a moist mixture of peat and other materials.
9. Initiation—lowering temperature, increasing humidity to 95%, increasing air circulation, decreasing carbon dioxide and/or introducing light.
10. Cropping—maintaining temperature, lowering humidity to 85-92%, maintaining air circulation, carbon dioxide and/or light levels.

With many species moderate crops can be produced on cased grain cultures. Or, the cultivator can go one step further and inoculate compost, straw or wood. In either case, the fruiting of mushrooms requires a high humidity environment that can be readily controlled. Without proper moisture, mushrooms don't grow.

In the subsequent chapters standard methods for germinating spores are discussed, followed by Techniques for growing mycelium on agar, producing grain and/or bran "spawn", preparing composted and non-composted substrates, spawn running, casing and pinhead formation. With this last step the methods for fruiting various species diverge and techniques specific to each mushroom are individually outlined. A trouble-shooting guide helps cultivators identify and solve problems that are commonly encountered. This is followed by a thorough analysis of the contaminants and pests of mushroom culture and a chapter explaining the nature of mushroom genetics. In all, the book is a system of knowledge that integrates the various techniques developed by commercial growers worldwide and makes the cultivation of mushrooms at home a practical endeavor.

---

## MUSHROOMS AND MUSHROOM CULTURE

Mushrooms inspire awe in those encountering them. They seem different. Neither plant-like nor animal-like, mushrooms have a *texture*, appearance and manner of *growth* all their own. Mushrooms represent a small branch in the evolution of the fungal kingdom Eumycota and are commonly known as the "fleshy *fungi*". In fact, fungi are non-photosynthetic organisms that evolved from algae. The primary role of fungi in the ecosystem is decomposition, one organism in a succession of microbes that break down dead organic matter. And although tens of thousands of fungi are known, mushrooms constitute only a small fraction, amounting to a few thousand species.

Regardless of the species, several steps are universal to the cultivation of all mushrooms. Not surprisingly, these initial steps directly reflect the life cycle of the mushroom. The role of the cultivator is to isolate a particular mushroom species from the highly competitive natural *world* and implant it in an environment that gives the mushroom plant a distinct advantage over competing organisms. The three major steps in the growing of mushrooms *parallel* three phases in their life cycle. They are:

1. Spore collection, spore germination and isolation of mycelium; or tissue cloning.
2. Preparation of inoculum by the expansion of mycelial mass on enriched agar media and then on grain. Implantation of grain spawn into composted and uncomposted substrates or the use of grain as a fruiting substrate.
3. Fruitbody (mushroom) initiation and development.

Having a basic understanding of the mushroom life *cycle* greatly aids the learning of techniques essential to cultivation.

Mushrooms are the fruit of the *mushroom* plant, the **mycelium**. A mycelium is a vast network of interconnected cells that permeates the ground and lives perennially. This resident mycelium only produces **fruitbodies**, what are commonly called mushrooms, under optimum conditions of temperature, humidity and nutrition. For the most part, the parent mycelium has but one recourse for insuring the survival of the species: to release enormous numbers of spores. This is accomplished through the generation of mushrooms.

In the life cycle of the mushroom plant, the fruitbody occurs briefly. The mycelial network can sit dormant for months, sometimes years and may only produce a single *flush* of mushrooms. During those few weeks of fruiting, the mycelium is in a frenzied state of growth, amassing nutrients and forming dense ball-like masses called **primordia** that eventually enlarge into the towering mushroom structure. The gills first develop from the *tissue* on the underside of the cap, appearing as folds, then becoming blunt ridges and eventually extending into flat, vertically aligned plates. These efficiently arranged symmetrical gills are populated with spore producing *cells* called **basidia**.

From a structural point of view, the mushroom is an efficient reproductive body. The cap acts as a domed shield protecting the underlying gills from the damaging effects of rain, wind and sun. Covering the gills in many species is a well developed layer of tissue called the **partial veil** which extends from the cap margin to the stem. Spores start falling from the gills just before the partial veil tears. *After* the partial veil has fallen, spores are projected from the gills in ever increasing numbers.

---

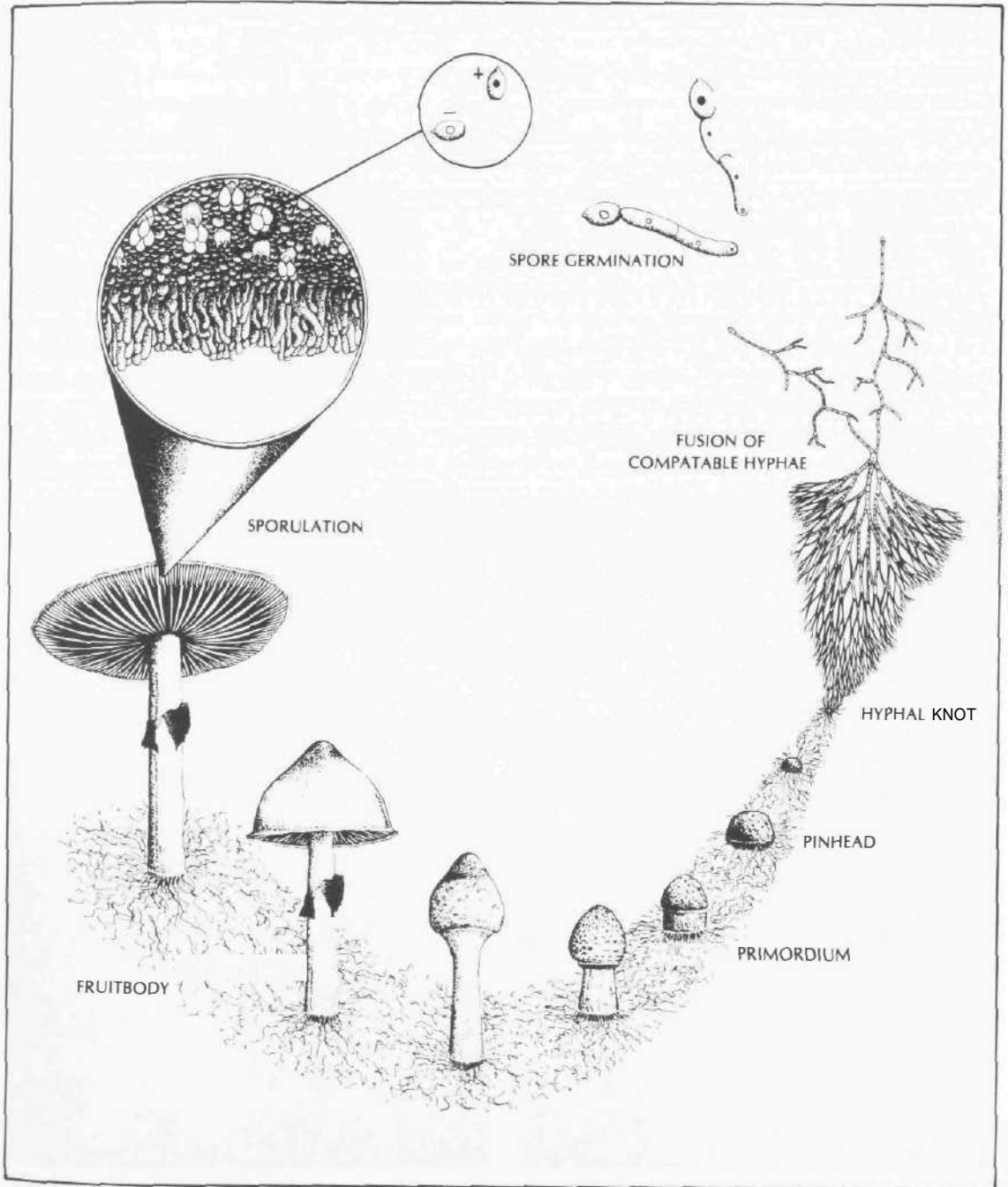

Figure 2 The Mushroom Life Cycle.



The cap is supported by a pillar-like stem that elevates the gills above ground where the spores can be carried off by the slightest wind currents. Clearly, every part of the mushroom fruitbody is designed to give the spores the best opportunity to mature and spread in an external environment that is often harsh and drastically fluctuating.

As the mushroom matures, spore production slows and eventually stops. At this time mushrooms are in their last hours of life. Soon decay from bacteria and other fungi sets in, reducing the once majestic mushroom into a soggy mass of fetid tissue that melts into the ground from which it sprung.

## THE MUSHROOM LIFE CYCLE

Cultivating mushrooms is one of the best ways to observe the entirety of the Mushroom Life Cycle. The life cycle first starts with a spore which produces a **primary** mycelium. When the mycelium originating from two spores mates, a **secondary mycelium** is produced. This mycelium continues to grow *vegetatively*. When vegetative mycelium has matured, its cells are capable of a phenomenal rate of reproduction which culminates in the erection of mushroom fruitbody. This represents the last functional change and it has become, in effect, **tertiary** mycelium. These types of mycelia represent the three major phases in the progression of the mushroom life cycle.

Most mushrooms produce spores that are **uninucleate** and genetically **haploid** (1N). This means each spore contains one nucleus and has half the complement of chromosomes for the species. Thus spores have a "sex" in that each has to mate with mycelia from another spore type to be fertile for producing offspring. When spores are first released they are fully inflated "moist" cells that can easily germinate. Soon they dehydrate, collapsing at their centers and in this phase they can sit dormant through long periods of dry weather or severe drought. When weather conditions pro-

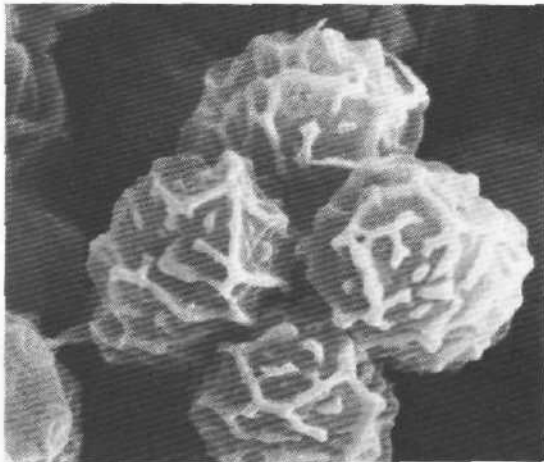

Figure 3 Scanning electron micrograph of *Russula* spores.

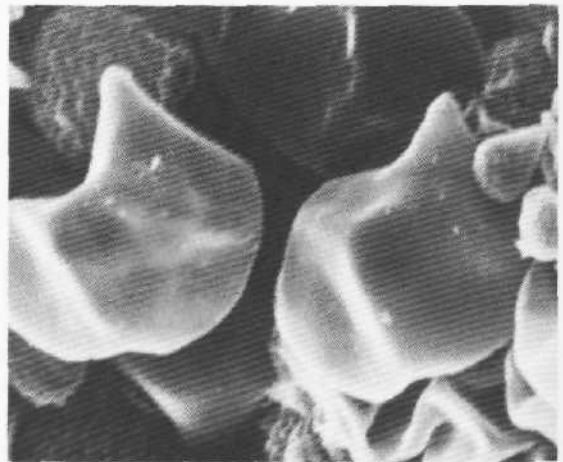
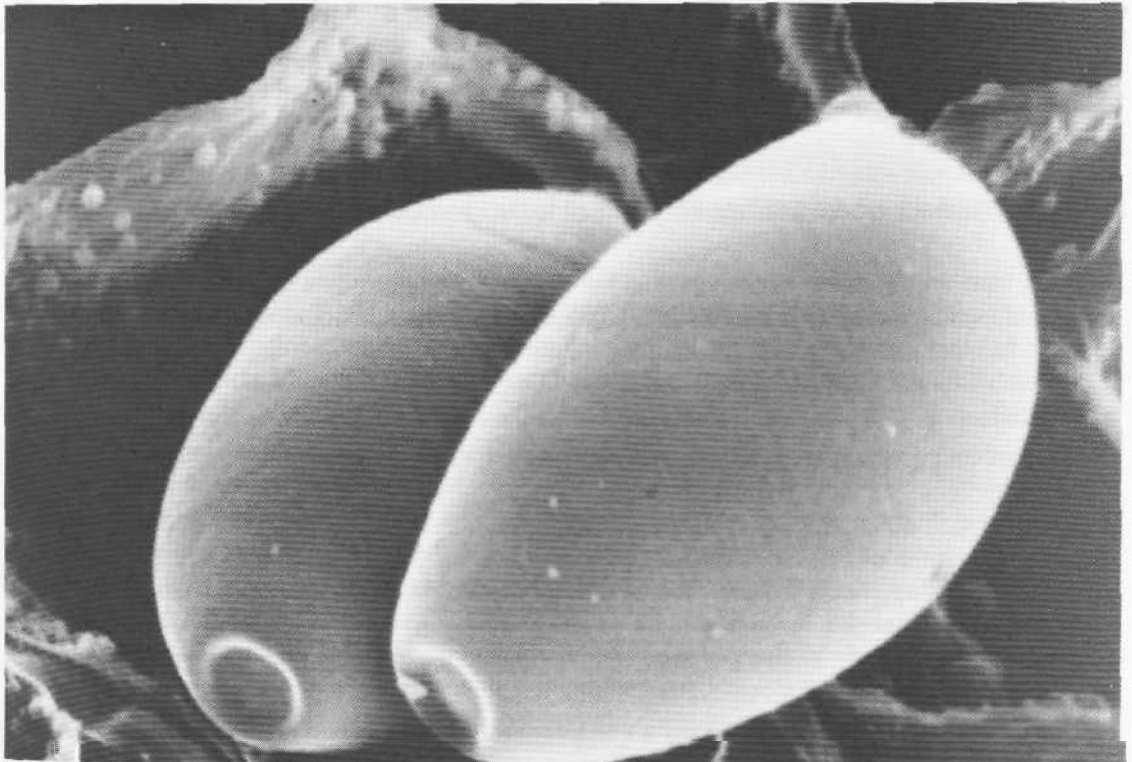

Figure 4 Scanning electron micrograph of *Entoloma* spores.

vide a sufficiently moist environment, the spores rehydrate and fully inflate. Only then is germination possible.

Spores within an individual species are fairly constant in their shape and structure. However, many mushroom species differ remarkably in their spore types. Some are smooth and lemon shaped (in the genus *Copelandia*, for instance); many are ellipsoid (as in the genus *Psilocybe*); while others are highly ornamented and irregularly shaped (such as those in *Lactarius* or *Entoloma*). A feature common to the spores of many mushrooms, particularly the *psilocybian* species, is the formation of an apical **germ pore**.

The germ pore, a circular depression at one end of the spore, is the site of germination from which a haploid strand of mycelium called a **hypha** emanates. This **hypha** continues to grow, branches and becomes a **mycelial network**. When two sexually complementary hyphal networks intercept one another and make **contact**, cell walls separating the two hyphal systems dissolve and cytoplasmic and **genetic** materials are exchanged. Erotic or not, this is "mushroom sex". Henceforth, all resulting mycelium is **binucleate** and **dikaryotic**. This means each cell has two nuclei and a full complement of chromosomes. With few exceptions, only mated (dikaryotic) mycelia is fertile and capable of producing fruitbodies. Typically, dikaryotic mycelia is faster running and more



**Figure 5** High resolution scanning electron micrograph showing germ pores of *Psilocybe pelliculosa* spores.

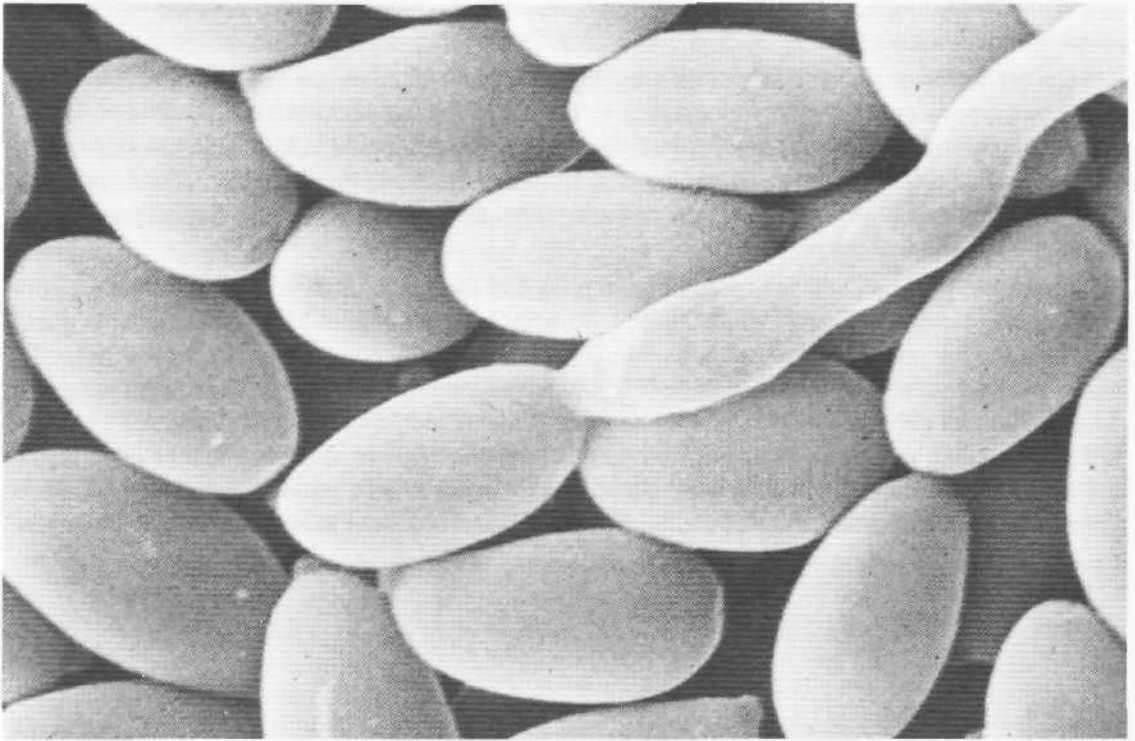

**Figure 6** Scanning electron micrograph of a *Psilocybe baeocystis* spore germinating.

vigorous than unmated, monokaryotic mycelia. Once a mycelium has entered into the dikaryo-phase, fruiting can occur shortly thereafter. In *Psilocybe cubensis*, the time between spore germination and fruitbody initials can be as brief as two weeks; in some *Panaeolus* species only a week transpires before mushrooms appear. Most mushroom species, however, take several weeks or months before mushrooms can be generated from the time of spore germination.

Cultivators interested in developing new strains by crossing single spore isolates take advantage of the occurrence of **clamp connections** to tell whether or not mating has taken place. Clamp connections are microscopic bridges that protrude from one adjoining cell to another and are only found in dikaryotic mycelia. Clamps can be readily seen with a light microscope at 100-400X magnification. Not all species form clamp connections. (*Agaricus brunnescens* does not; most all *Psilocybe* and *Panaeolus* species do). In contrast, mycelia resulting from haploid spores lack clamps. This feature is an invaluable tool for the researcher developing new strains. (For more information on breeding strategies, see Chapter XV.)

Two dikaryotic mycelial networks can also grow together, exchange genetic material and form a new strain. Such an encounter, where two hyphal systems fuse, is known as **anastomosis**. When two incompatible colonies of mycelia meet, a zone of inhibited growth frequently forms. On agar media, this zone of incompatibility is visible to the unaided eye.

---

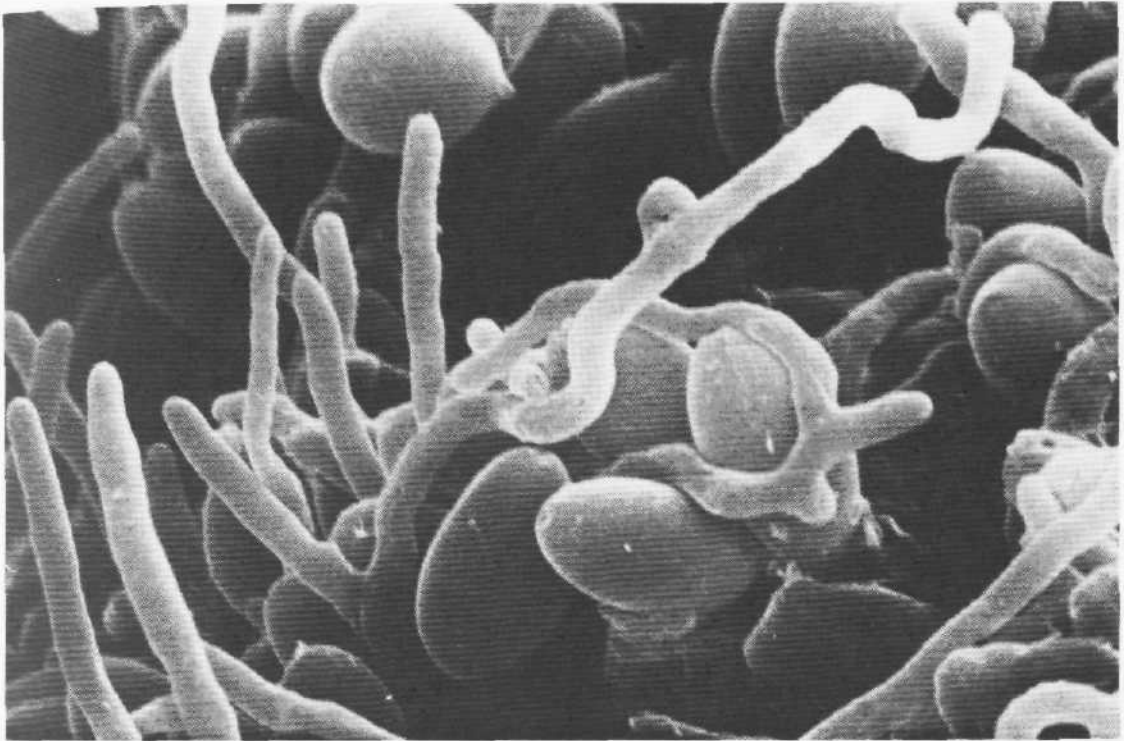

**Figure 7** Scanning electron micrograph of hyphae emanating from a bed of germinating *Psilocybe cubensis* spores.

When a mycelium produces mushrooms, several radical changes in its metabolism occurs. Up to this point, the mycelium has been growing vegetatively. In the vegetative state, hyphal cells are amassing nutrients. Curiously, there is a gradual increase in the number of nuclei per cell, sometimes to as many as ten just prior to the formation of mushrooms. Immediately before fruitbodies form, new cell walls divide the nuclei, reducing their number per cell to an average of two. The high number of nuclei per cell in pre-generative mycelia seems to be a prerequisite for fruiting in many mushroom species.

As the gills mature, basidia cells emerge in ever increasing numbers, first appearing as small bubble-like cells and resembling cobblestones on a street. The basidia are the focal point in the reproductive phase of the mushroom life cycle. The basidia, however, do not mature all at once. In the genus *Panaeolus* for instance, the basidia cells mature regionally, giving the gill surface a spotted look. The cells giving rise to the basidia are typically binucleate, each nucleus is haploid (1N) and the cell is said to be dikaryotic. The composition of the young basidia cells are similar. At a specific point in time, the two nuclei in the basidium migrate towards one another and merge into a single diploid (2N) nucleus. This event is known as **karyogamy**. Soon thereafter, the diploid nucleus undergoes meiosis and typically produces four haploid daughter cells.

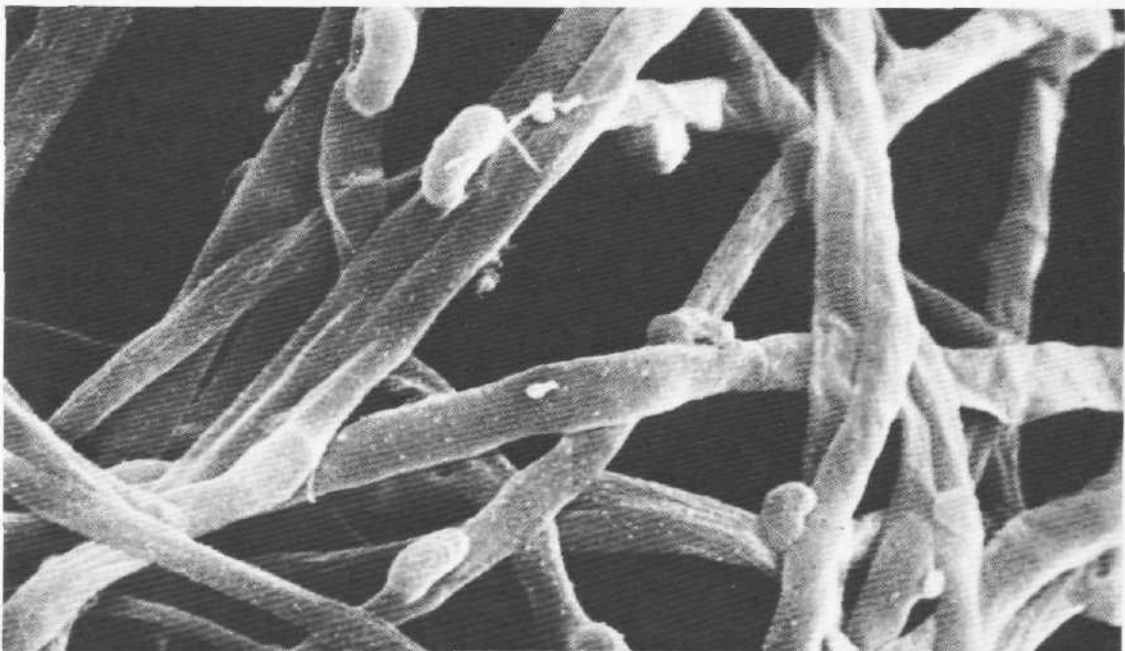
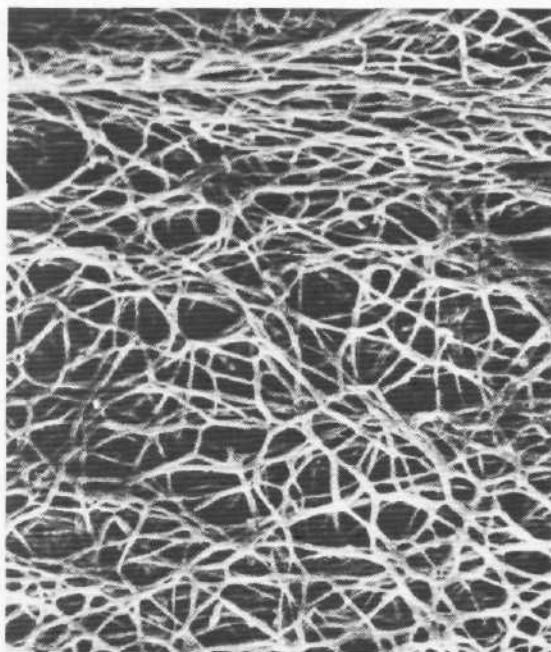
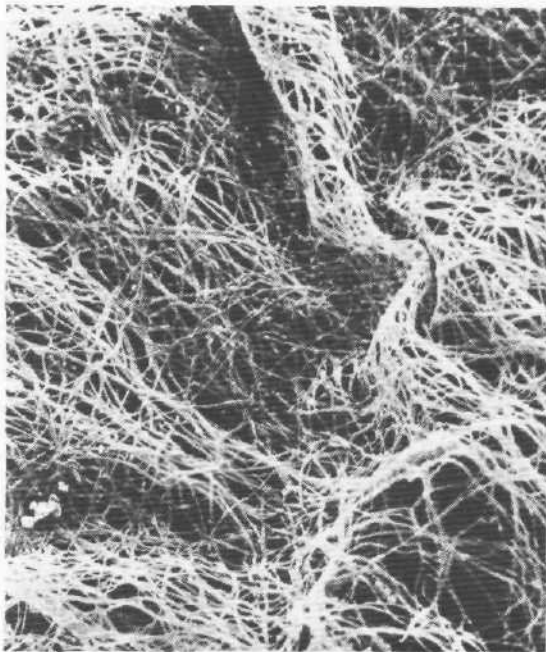

**Figure 8, 9, & 10** Scanning electron micrographs of the mycelial network of *Psilocybe cubensis*. Note hyphal crossings and clamp connections.

On the surface of the basidia, arm-like projections called **sterigmatae** arise through which these nuclei then migrate. In most species four spores form at the tips of these projections. The spores continue to develop until they are forcefully liberated from the basidia and propelled into free space. The mechanism for spore release has not yet been proven. But, the model most widely accepted within the mycological community is one where a "gas bubble" forms at the junction of the spore and the sterigmata. This gas bubble inflates, violently explodes and jettisons the spore into the cavity between the gills where it is taken away by air currents. Most commonly, sets of opposing spores are released in this manner. With spore release, the life cycle is completed.

Not all mushroom species have basidia that produce four haploid spores. *Agaricus brunnescens* (= *Agaricus bisporus*), the common button mushroom, has basidia with two diploid (2N) spores. This means each spore can evolve into a mycelium that is fully capable of producing mushrooms. *Agaricus brunnescens* is one example of a diploid bipolar species. Some Copelandian Panaeoli (the strongly bluing species in the genus *Panaeolus*) are two spored and have mating properties similar to *Agaricus brunnescens*. Other mushroom species have exclusively three spored basidia; some have five spored basidia; and a few, like the common Chantarelle, have as many as eight spores per basidium!

An awareness of the life cycle will greatly aid beginning cultivators in their initial attempts to cultivate mushrooms. Once a basic understanding of mushroom culture and the life processes of these organisms is achieved, cultivators can progress to more advanced subjects like genetics, strain selection and breeding. This wholistic approach increases the depth of one's understanding and facilitates development of innovative approaches to mushroom cultivation.

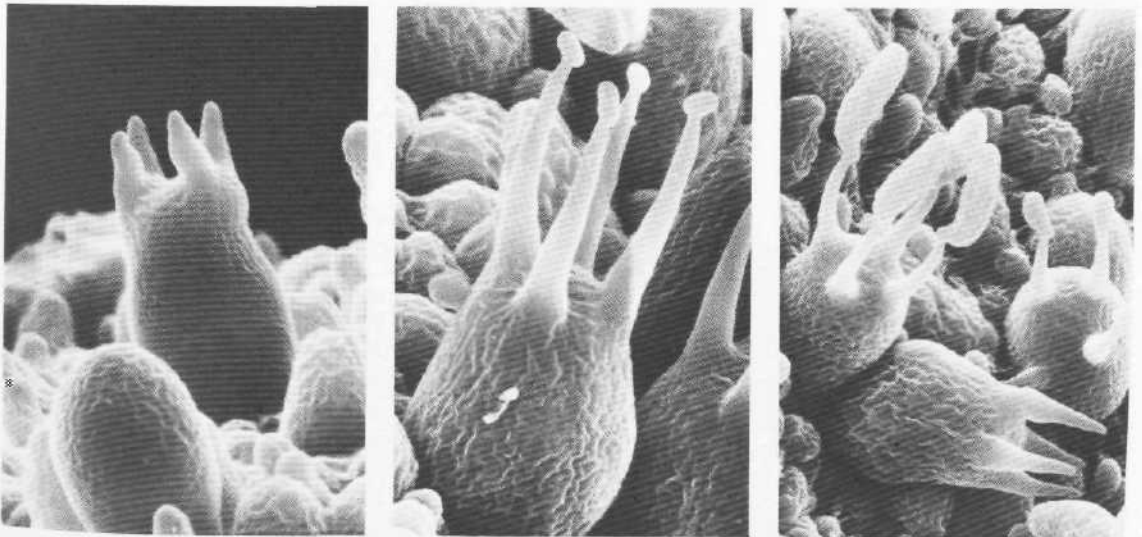

Figure 11, 12 & 13 Scanning electron micrographs showing the development of the basidium and spores in *Ramaria longispora*, a coral fungus.

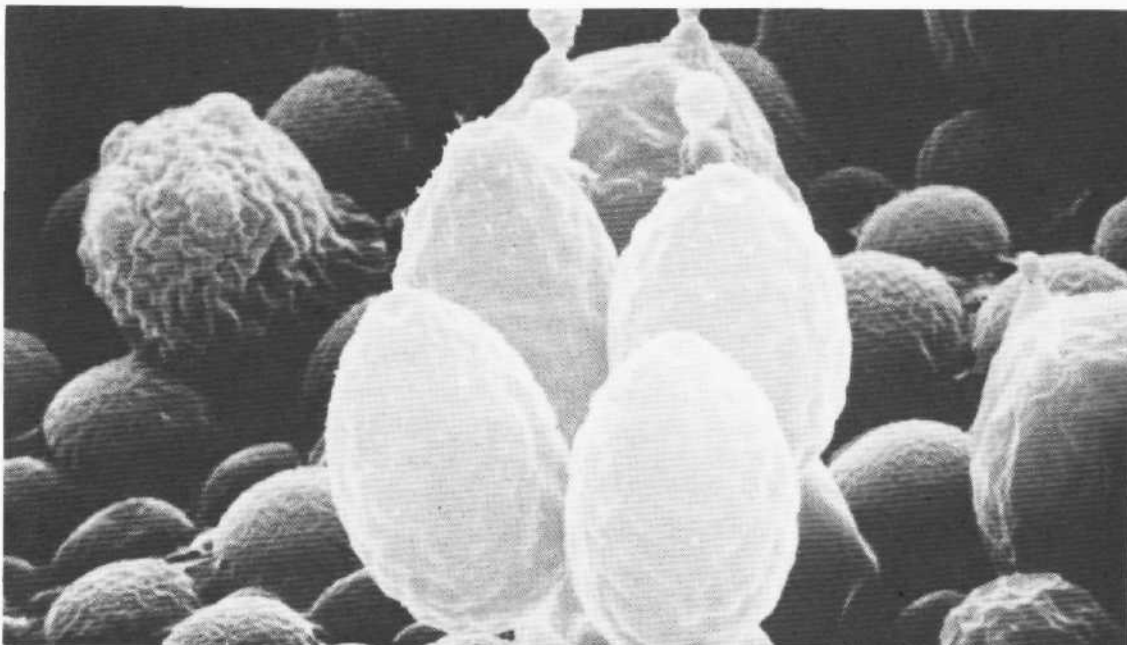

Figure 14 Scanning electron micrograph of mature basidium in *Panaeofus foeniseeii*.

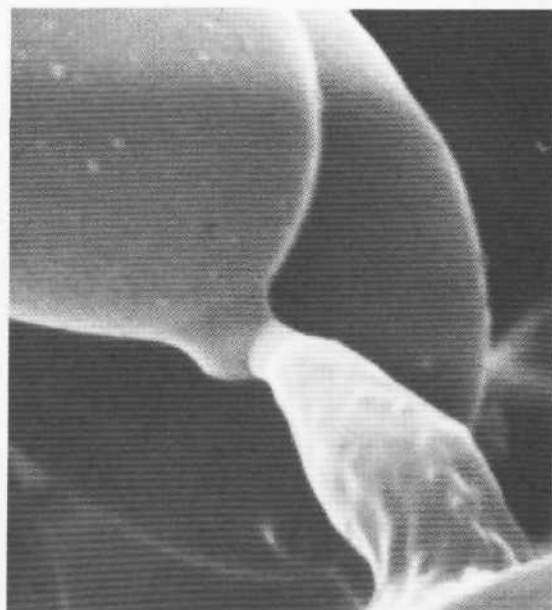
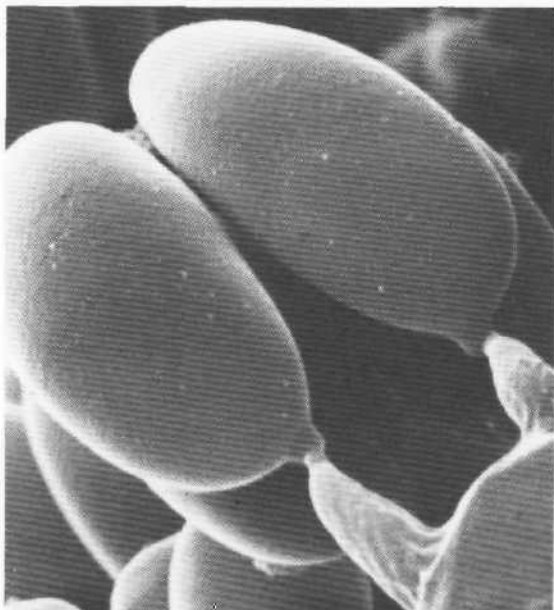

Figure 15a, 15b Scanning electron micrographs showing basidium of *Psilocybe pelliculosa*. Note spore/sterigmata junction.

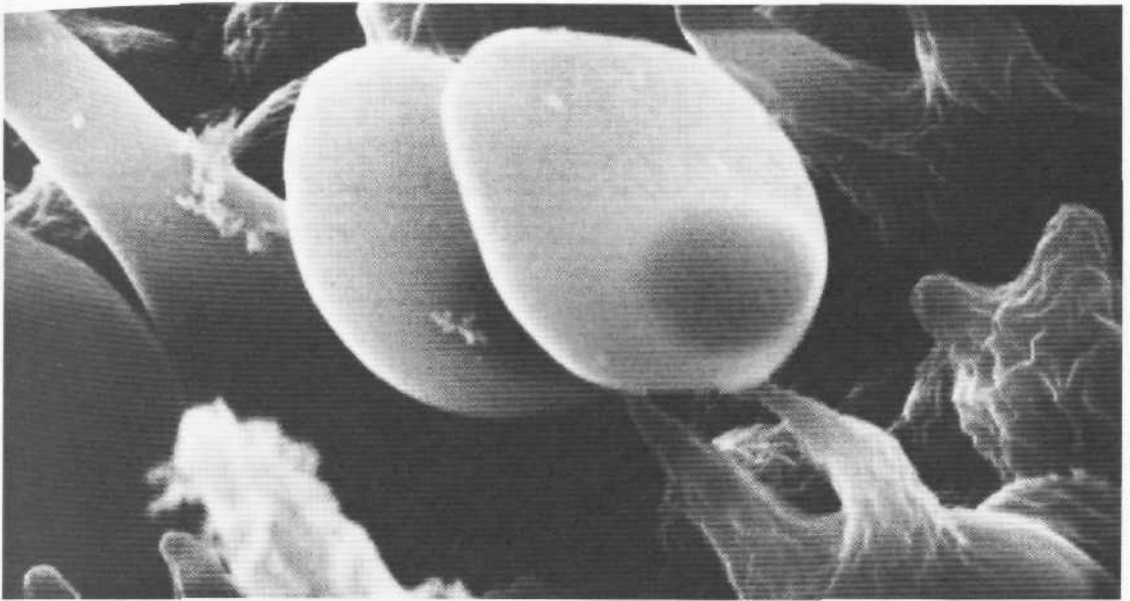

Figure 16 Scanning electron micrograph of two spored basidium of an as yet **unpub-**lished species closely related to *Copelandia cyanescens*. Note “shadow” nuclei visible within each spore.

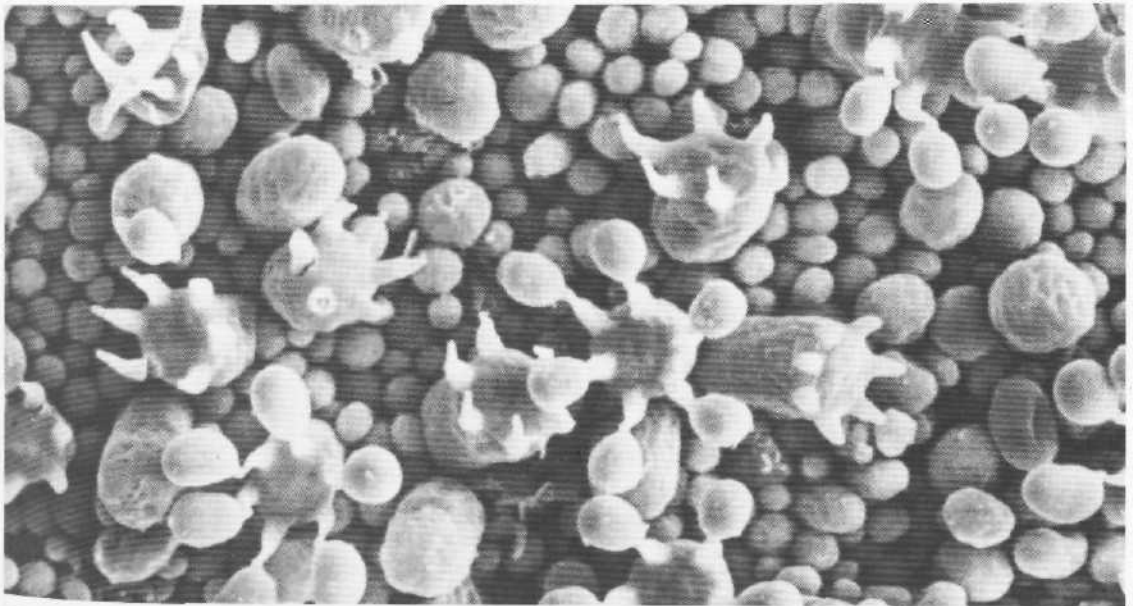

Figure 17 Scanning electron micrograph of the gill surface of *Cantharellus cibarius*. Note six and eight spored basidia.



## CHAPTER II STERILE TECHNIQUE AND AGAR CULTURE



Figure 18 A home cultivator's pantry converted into a sterile laboratory.

**T**he air we breathe is a living sea of microscopic organisms that ebbs and flows with the slightest wind currents. Fungi, bacteria, viruses and plants use the atmosphere to carry their offspring to new environments. These microscopic particles can make sterile technique difficult unless proper precautions are taken, [f one can eliminate or reduce the movement of these organisms in the air, however, success in sterile technique is assured.

There are five primary sources of contamination in mushroom culture work:

1. The immediate external environment
2. The culture medium
3. The culturing equipment
4. The cultivator and his or her clothes
5. The mushroom spores or the mycelium

Mushrooms—and all living organisms—are in constant competition for available nutrients. In creating a sterile environment, the cultivator seeks to give advantage to the mushroom over the myriad legions of other competitors. Before culture work can begin, the first step is the construction of an inoculation chamber or sterile laboratory.

## **DESIGN AND CONSTRUCTION OF A STERILE LABORATORY**

The majority of cultivators fail because they do not take the time to construct a laboratory for sterile work. An afternoon's work is usually all that is required to convert a walk-in closet, a pantry or a small storage room into a workable inoculation chamber.

Begin by removing all rugs, curtains and other cloth-like material that can harbor dust and spores. Thoroughly clean the floors, walls and ceiling with a mild disinfectant. Painting the room with a high gloss white enamel will make future cleaning easier. Cover windows or any other sources of potential air leaks with plastic sheeting. On either side of the room's entrance, using plastic sheeting or other materials, construct an antechamber which serves as an airlock. This acts as a protective buffer between the laboratory and the outside environment. The chamber should be designed so that the sterile room door is closed while the anteroom is entered. Equip the lab with these items:

1. a chair and a sturdy table with a smooth surface
2. a propane torch, an alcohol lamp, a bunsen burner or a butane lighter.
3. a clearly marked spray bottle containing a 10% bleach solution.
4. sterile petri dishes and test tube "slants".
5. stick-on labels, notebook, ballpoint pen and a permanent marking pen.
6. an agar knife and inoculating loop.

All these items should remain in the laboratory. If any equipment is removed, make sure it is absolutely clean before being returned to the room.

---

A semisterile environment can be established in the laboratory through simple maintenance depending on the frequency of use. The amount of cleaning necessary will be a function of the spore load in the external environment. In winter the number of free spores drastically decreases while in the spring and summer months one sees a remarkable increase. Consequently, more cleaning is necessary during these peak contamination periods. More importantly, all contaminated jars and petri dishes should be disposed of in a fashion that poses no risk to the sterile lab.

Once the sterile work room has been constructed, follow a strict and unwavering regimen of hygiene. The room should be cleaned with a disinfectant, the floors mopped and lastly the room's air washed with a fine mist of 10% bleach solution. After spraying, the laboratory should not be re-entered for a minimum of 15 minutes until the suspended particles have settled. A regimen of cleaning **MUST** precede every set of inoculations. As a rule, contamination is easier to prevent than to eliminate after it occurs.

Before going further, a few words of caution are required. Sterile work demands concentration, attention to detail and a steady hand. Work for reasonable periods of time and not to the point of exhaustion. Never leave a lit alcohol lamp or butane torch unattended and be conscious of the fact that in an airtight space oxygen can soon be depleted.

Some cultivators wage war on contamination to an unhealthy and unnecessary extreme. They tend to "overkill" their laboratory with toxic fungicides and bacteriocides, exposing themselves to dangerously mutagenic chemical agents. In one incident a worker entered a room that had just been heavily sprayed with a phenol based germicide. Because of congestion he could not sense the danger and minutes later experienced extreme shortness of breath, numbness of the extremities and convulsions. These symptoms persisted for hours and he did not recover for several days. In yet another instance, a person mounted a short wave ultraviolet light in a glove box and conducted transfers over a period of months with no protection and unaware of the danger. This type of light can cause skin cancer after prolonged exposure. Other alternatives, posing little or no health hazard, can just as effectively eliminate contaminants, sometimes more so.

If despite one's best efforts a high contamination rate persists, several additional measures can be implemented. The first is inexpensive and simple, utilizing a colloidal suspension of light oil into the laboratory's atmosphere; the second involves the construction of a still air chamber called a glove box; and the third is moderately expensive, employing high efficiency micron filters.

- 1 - By asperating sterile oil, a cloud of highly viscous droplets is created. As the droplets descend they trap airborne contaminant particles. This technique uses triethylene glycol that is vaporized through a heated wick. Finer and more volatile than mineral oil, triethylene glycol leaves little or no noticeable film layer. However a daily schedule of hygiene maintenance is still recommended. (A German Firm sells a product called an "aero-disinfector" that utilizes the low boiling point of Triethylene glycol. For information write: Chemische Fabrik Bruno Vogelmann & Co., Postfach 440, 718 Crailsheim, West Germany. The unit sells for less than \$50.00).
2. A glovebox is an airtight chamber that provides a semisterile still air environment in which to conduct transfers. Typically, it is constructed of wood, with a sneeze window for viewing

and is sometimes equipped with rubber gloves into which The cultivator inserts his hands. Often, in place of gloves, the front face is covered with a removable cotton cloth that is periodically sterilized. The main advantage of a glove box is that it provides an inexpensive, easily cleaned area where culture work can Take place with little or no air movement.

3. Modern laboratories solve the problem of airborne contamination by installing High Efficiency Particulate Air (HEPA) filters. These filters screen out all particulates exceeding 0.1 -0.3 microns in diameter, smaller than the spores of all fungi and practically all bacteria. HEPA filters are built into what is commonly known as a laminar flow hood. Some sterile laboratories have an entire wall or ceiling constructed of HEPA filters through which pressurized air is forced from the outside. In effect, a positive pressure, sterile environment is created. Specific data regarding the building and design of laminar flow systems is discussed in greater detail in Appendix IV.

Some cultivators have few problems with contaminants while working in what seems like the most primitive conditions. Others encounter pronounced contamination levels and have to invest in high technology controls. Each circumstance dictates an appropriate counter-measure. Whether one is a home cultivator or a spawn maker in a commercial laboratory, the problems encountered are similar, differing not in kind, but in degree.

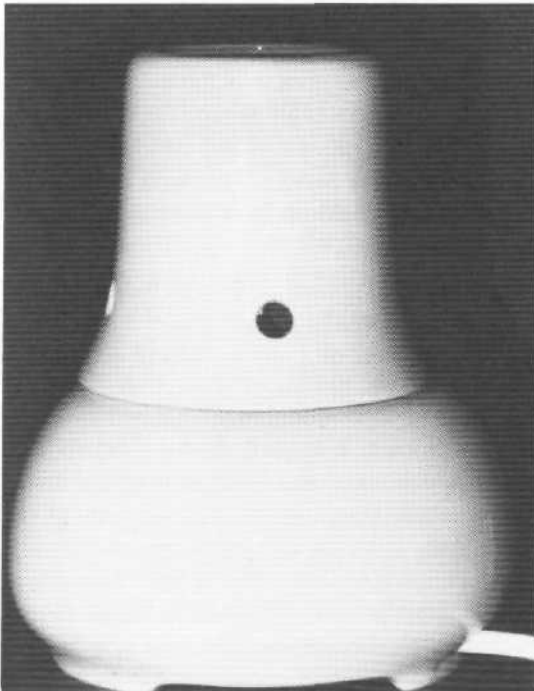

**Figure 19** Aero-disinfector for reducing contaminant spore load in laboratory.

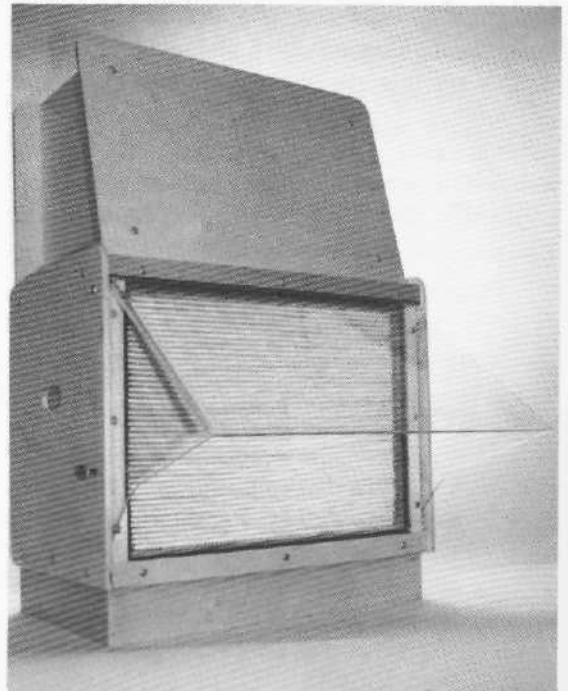

**Figure 20** Laminar flow hood,

## PREPARATION OF AGAR MEDIA

Once the sterile laboratory is completed, the next step is the preparation of nutrified agar media. Derived from seaweed, agar is a solidifying agent similar to but more effective than gelatin. There are many recipes for producing enriched agar media suitable for mushroom culture. The standard formulas have been Potato Dextrose Agar (PDA) and Malt Extract Agar (MEA) to which yeast is often added as a nutritional supplement. Many of the mycological journals list agar media containing peptone or neopeptone, two easily accessed sources of protein for mushroom mycelium. Another type of agar media that the authors recommend is a broth made from boiling wheat or rye kernels which is then supplemented with malt sugar.

If a high rate of contamination from bacteria is experienced, the addition of antibiotics to the culture media will prevent their growth. Most antibiotics, like streptomycin, are not autoclavable and must be added to the agar media after sterilization while it is still molten. One antibiotic, gentamycin sulphate, survives autoclaving and is effective against a broad range of bacteria. Antibiotics should be used sparingly and only as a temporary control until the sources of bacteria can be eliminated. The mycelia of some mushroom species are adversely affected by antibiotics.

Dozens of enriched agar media have been used successfully in the cultivation of fungi and every cultivator develops distinct preferences based on experience. Regardless of the type of agar medium employed, a major consideration is its pH, a logarithmic scale denoting the level of acidity or alkalinity in a range from 0 (highly acidic) to 14 (highly basic) with 7 being neutral. Species of *Psilocybe* thrive in media balanced between 6.0-7.0 whereas *Agaricus brunnescens* and allies grow better in near neutral media. Most mycelia are fairly tolerant and grow well in the 5.5-7.5 pH

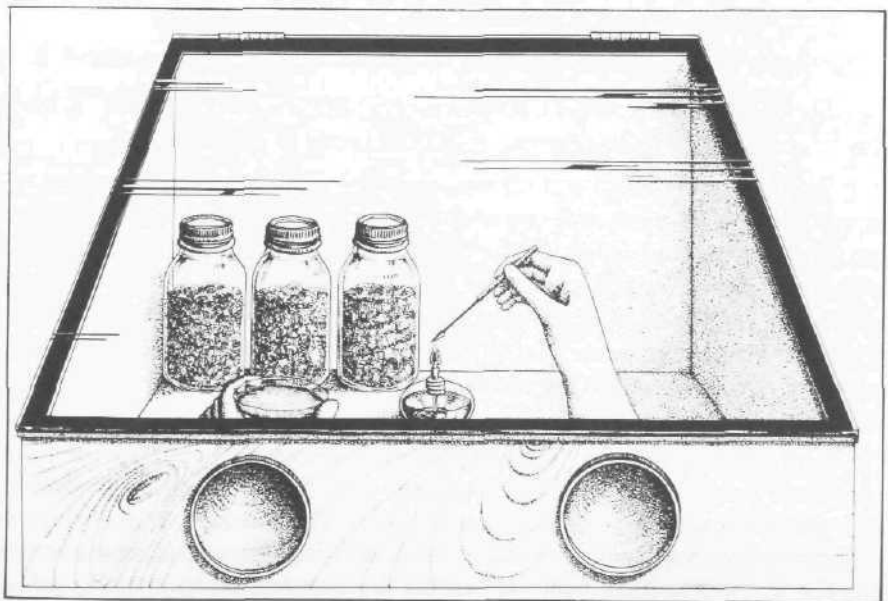

**Figure 21**  
Standard  
glove box.

range. One needs to be concerned with exact pH levels only if spores fail to germinate or if mycelial growth is unusually slow.

What follows are several formulas for the preparation of nutritionally balanced enriched agar media, any one of which is highly suited for the growth of *Agaricus*, *Pleurotus*, *Lentinus*, *Stropharia*, *Lepisia*, *Flammulina*, *Volvariella*, *Panaeolus* and *Psilocybe* mycelia. Of these the authors have two preferences: PDY (Potato Dextrose Yeast) and MPG (Malt Peptone Grain) agar media. The addition of ground rye grain or grain extract to whatever media is chosen clearly promotes the growth of strandy mycelium, the kind that is generally preferred for its fast growth.

Choose one formula, mix the ingredients in dry form, place into a flask and add water until one liter of medium is made.

**PDY (Potato Dextrose Yeast) Agar**

the filtered, extracted broth from boiling  
300 grams of sliced potatoes in 1 liter of  
water for 1 hour  
20 grams agar  
10 grams dextrose sugar  
20 grams yeast

**MEA (Malt Extract Agar)**

20 grams tan malt  
2 grams yeast

Avoid dark brewer's malts which have become carmellized. The malt that should be used is a light tan brewer's (optional)

**MPG (Malt Peptone Grain) Agar**

20 grams tan malt  
5 grams ground rye grain  
5 grams peptone or neopeptone  
2 grams yeast (optional)  
20 grams agar

For controlling bacteria, 0.10 grams of 60-80% pure gentamycin sulphate can be added to each liter of media prior to sterilization. (See Resources in Appendix.)

Water quality—its pH and mineral content—varies from region to region. If living in an area of questionable water purity, the use of distilled water is advisable. For all practical purposes, however, tap water can be used without harm to the mushroom mycelium. A time may come when balancing pH is important—especially at spore germination or in the culture of exotic species. The pH of media can be altered by adding a drop at a time of 1 molar concentration of hydrochloric acid (HCL) or sodium hydroxide (NaOH). The medium is thoroughly mixed and then measured using a pH meter or pH papers. (One molar HCL has a pH of 0; one molar NaOH has a pH of 12; and distilled water has a pH of 7).

After thoroughly mixing these ingredients, sterilize the medium in a pressure cooker for 30 minutes at 15 psi. (Pressure cookers are a safe and effective means of sterilizing media provided they are operated according to the manufacturer's instructions). A small mouthed vessel is recommended for holding the agar media. If not using a flask specifically manufactured for pouring media, any narrow necked glass bottle will suffice. Be sure to plug its opening with cotton and cover with

---

aluminum foil before inserting into the pressure cooker. The media container should be filled only to  $\frac{2}{3}$  to  $\frac{3}{4}$  of its capacity.

Place the media filled container into the pressure cooker along with an adequate amount of water for generating steam. (Usually a  $\frac{1}{2}$  inch layer of water at the bottom will do). Seal the cooker according to the manufacturer's directions. Place the pressure cooker on a burner and heat until ample steam is being generated. Allow the steam to vent for 4-5 minutes before closing the stop-cock. Slowly bring the pressure up to 15 psi and maintain for  $\frac{1}{2}$  hour. Do not let the temperature of the cooker exceed 250 °F. or else the sugar in the media will caramelize. Media with caramelized sugar inhibits mycelial growth and promotes genetic mutations.

A sterilized pot holder or newly laundered cloth should be handy in the sterile lab to aid in removing the media flask from the pressure cooker. While the media is being sterilized, immaculately clean the laboratory.

The time necessary for sterilization varies at different altitudes. At a constant volume, pressure and temperature directly correspond (a relationship known as Boyle's Law). When a certain pressure (= temperature) is recommended, it is based on a sea level standard. Those cultivating at higher elevations must cook at higher pressures To achieve the same sterilization effect. Here are two abbreviated charts showing the relationships between Temperature and pressure and the changes in the boiling point of water at various elevations. Increase the amount of pressure over the recommended amount based on the difference of the boiling point at sea level and one's own altitude. For example, at 5000 feet the difference in the boiling point of water is approximately 10° F. This means that the pressure must be increased to 20 psi, 5 psi above the recommended 15 psi sea level standard, to correspond To a "10° F. increase" in temperature. (Actually temperature remains the same; it is pressure that differs).

Relationship of Pressure and Temperature at Constant Volume		The Relationship of Altitude to the Boiling Point of Water	
Pressure (psi)	° Fahrenheit	Altitude	Boiling Point (° F.)
1	212	Sea Level	212
3	220	1,025	210
5	228	2,063	208
10	240	3,115	206
15	250	4,169	204
20	259	5,225	202
25	267	6,304	200
		7,381	197
		8,481	196
		9,031	195

Note that the effect achieved from sterilizing at 60 minutes at 15 psi is the same as that from 30 minutes at 30 psi. Hence a doubling of pressure reduces sterilization time by one half. Most pressure cookers can not be safely operated at this level unless carefully modified according to the

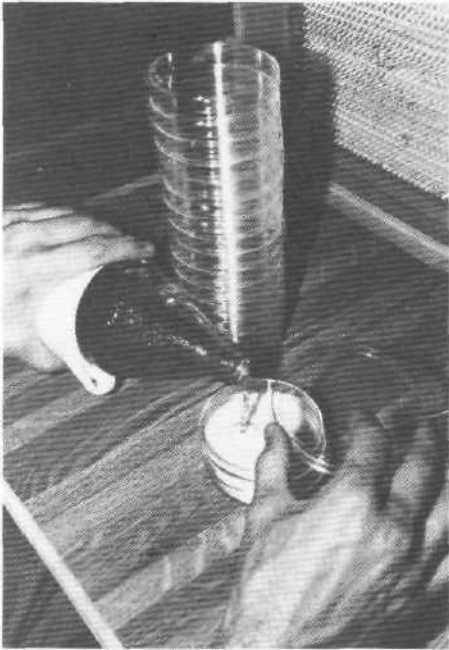

**Figure 22 & 23** Pouring agar media into sterile petri dishes. At left, vertical stack technique.

manufacturer's recommendations. And some extra time must be allowed for adequate penetration of steam, especially in densely packed, large autoclaves.

Once sterilized, place the cooker in the laboratory or in a semisterile room and allow the pressure to return to 1 psi before opening. One liter of agar media can generously fill thirty 100 x 15 mm. petri dishes. Techniques for pouring vary with the cultivator. If only one or two sleeves of petri dishes are being prepared, the plates should be laid out side by side on the working surface. If more Than two sleeves are being poured or table space is limited, pouring the sterile petri dishes in a vertical stack is usually more convenient.

Before pouring, vigorously shake the molten media to evenly distribute its ingredients. Experienced cultivators fill the plates rhythmically and without interruption. Allow the agar media to cool and solidify before using. Condensation often forms on The inside surface of The upper lid of a petri dish when the agar media being poured is still at a high temperature. To reduce condensation, one can wait a period of time before pouring. If the pressure cooker sits for 45 minutes after reaching 1 psi, a liter of liquid media can be poured with little discomfort To unprotected hands.

Two types of culTures can be obTained from a selected mushroom: one from its **spores** and The oTher from living **tissue** of a mushroom. Either Type can produce a viable strain of mycelia. Each has advantages and disadvantages.



## STARTING A CULTURE FROM SPORES

A mushroom culture can be started in one of two ways. Most growers start a culture from spores. The advantage of using spores is that they are viable for weeks to months after the mushroom has decomposed. The other way of obtaining a culture is to cut a piece of interior tissue from a live specimen, in effect a clone. Tissue cultures must be taken within a day or two from the time the mushroom has been picked, after which a healthy clone becomes increasingly difficult to establish.

### Taking a Spore Print

To collect spores, sever the cap from the stem of a fresh, well cleaned mushroom and place it gills down on a piece of clean white paper or a clean glass surface such as a microscope slide. If a specimen is partially dried, add a drop or two of water to the cap surface to aid in the release of spores. To lessen evaporation and disturbance from air currents, place a cup or glass over the mushroom cap. After a few hours, the spores will have fallen according to the radiating symmetry of the gills. If the spore print has been taken on paper, cut it out, fold it in half, seal in an airtight container and label the print with the date, species and collection number. When using microscope slides, the spores can be sandwiched between two pieces of glass and taped along the edges to prevent the entry of contaminant spores. A spore print carelessly taken or stored can easily become contaminated, decreasing the chance of acquiring a pure culture.

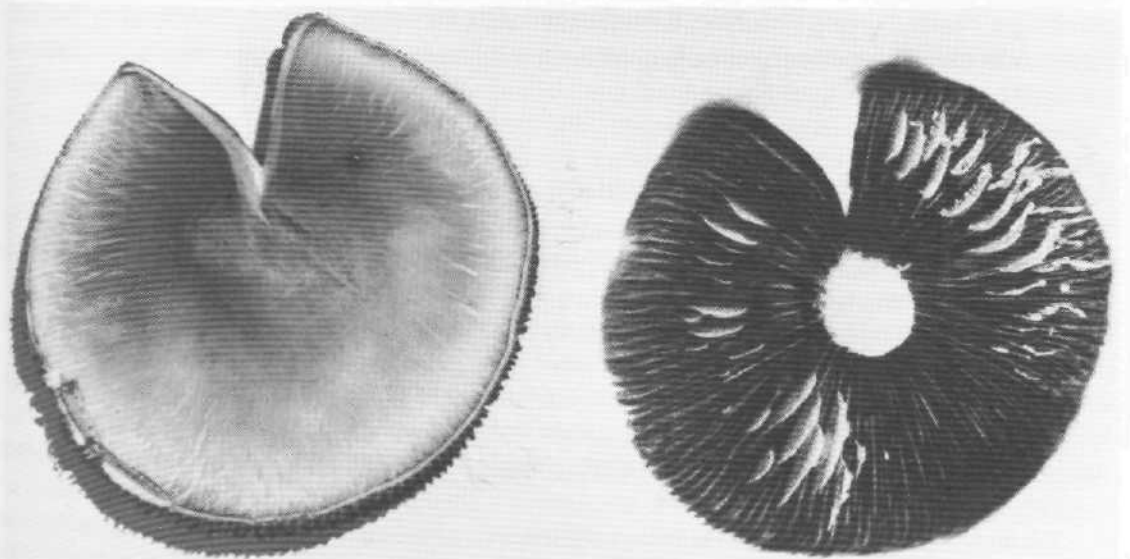

Fi Figure 24a Taking a spore print on typing paper.

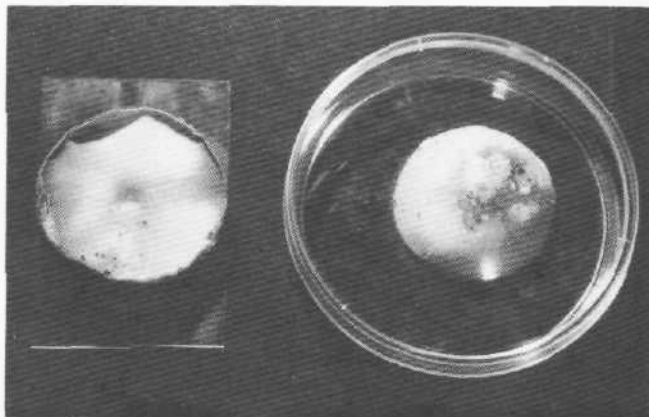
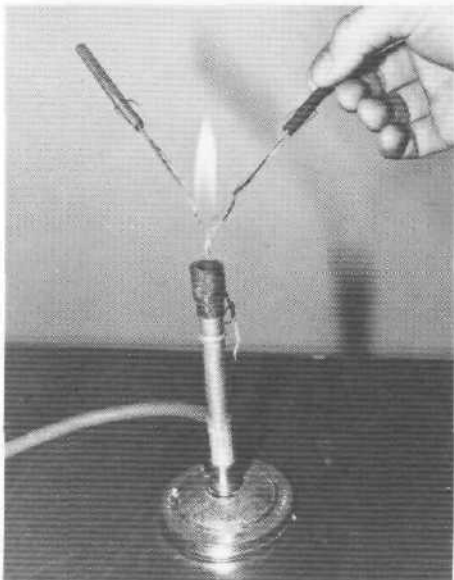

**Figure 24b** Taking a spore print on a sterile petri dish and on glass microscope slides.

**Figure 25** Sterilizing two scalpels speeds up agar transfer technique.

*Agaricus brunnescens*, *Psilocybe cubensis* and many other mushroom species have a partial veil—a thin layer of tissue extending from the cap margin to the stem. This veil can be an aid in the procurement of nearly contaminant-free spores. The veil seals the gill from the outside, creating a semi-sterile chamber from which spores can be removed with little danger of contamination. By choosing a healthy, young specimen with the veil intact, and then by carefully removing the veil tissue under aseptic conditions, a nearly pure spore print is obtained. This is the ideal way to start a multispore culture.

## Techniques for Spore Germination

Once a spore print is obtained, mushroom culture can begin. Sterilize an inoculating loop or scalpel by holding it over the flame of an alcohol lamp or butane torch for five or ten seconds until it is red hot. (If a butane torch is used, turn it down to the lowest possible setting to minimize air disturbance). Cool the tip by inserting it into the sterile media in a petri dish and scrape some spores off the print. Transfer the spores by streaking the tip of the transfer tool across the agar surface. A similar method calls for scraping the spore print above an opened petri dish and allowing them to free-fall onto the medium. When starting a new culture from spores, it is best to inoculate at least three media dishes to improve the chances of getting a successful germination. Mycelium started in this manner is called a multispore culture.

When first produced, spores are moist, inflated cells with a relatively high rate of germination. As time passes, they dry, collapse at their centers and can not easily germinate. The probability of germinating dehydrated spores increases by soaking them in sterilized water. For 30 minutes at 15 psi, sterilize an eye dropper or similar device (syringe or pipette) and a water filled test tube or

25-250 ml. Erlenmeyer flask stopped with cotton and covered with aluminum foil. Carefully touch spores onto a scalpel and insert into sterile water. Tightly seal and let stand for 6-12 hours. After this period draw up several milliliters of this spore solution with the eye dropper, syringe or pipette and inoculate several plates with one or two drops. Keep in mind that if the original spore print was taken under unsanitary conditions, this technique just as likely favors contaminant spores as the spores of mushrooms.

## Characteristics of the Mushroom Mycelium

With either method of inoculation, spore germination and any initial stages of contamination should be evident in three to seven days. Germinating spores are thread-like strands of cells emanating from a central point of origin. These mycelial strands appear grayish and diffuse at first and soon become whitish as more hyphae divide, grow and spread through the medium.

The mycelia of most species, particularly *Agaricus*, *Coprinus*, *Lentinus*, *Panaeolus* and *Psilocybe* are grayish to whitish in color. Other mushroom species have variously pigmented mycelia. *Lepista nuda* can have a remarkable purplish blue mycelium; *Psilocybe tampanensis* is often multi-colored with brownish hues. Keep in mind, however, that color varies with the strain and the media upon which the mycelium is grown. Another aspect of the mycelial appearance is its type of growth, whether it is aerial or appressed, cottony or rhizomorphic. Aerial mycelium can be species related or often it is a function of high humidity. Appressed mycelium can also be a species specific character or it can be the result of dry conditions. The subject of mycelial types is discussed in greater detail under the sub-chapter Sectoring, (See Color Photos 1 -4).

Once the mushroom mycelium has been identified, sites of germinating spores should be transferred to new media dishes. In this way the cultivator is selectively isolating mushroom mycelia and will soon establish a pure culture free of contamination. If contamination appears at the same time, cut out segments of the emerging mushroom mycelia away from the contaminant colonies. Since many of the common contaminants are sporulating molds, be careful not to jolt the culture or to do anything that might spread their spores. And be sure the scalpel is cool before cutting into the agar media. A hot scalpel causes an explosive burst of vapor which in the microcosm of the petri dish easily liberates spores of neighboring molds.

## Ramifications of Multispore Culture

Multispore culture is the least difficult method of obtaining a viable if not absolutely pure strain. In the germination of such a multitude of spores, one in fact creates many strains, some incompatible with others and each potentially different in the manner and degree to which they fruit under conditions. This mixture of inductive strains inhibiting the activity of more productive ones. In general, strains created from spores have a high probability of resembling their parents. If those parents have been domesticated and fruit well under laboratory conditions, their progeny can be expected to behave similarly. In contrast,

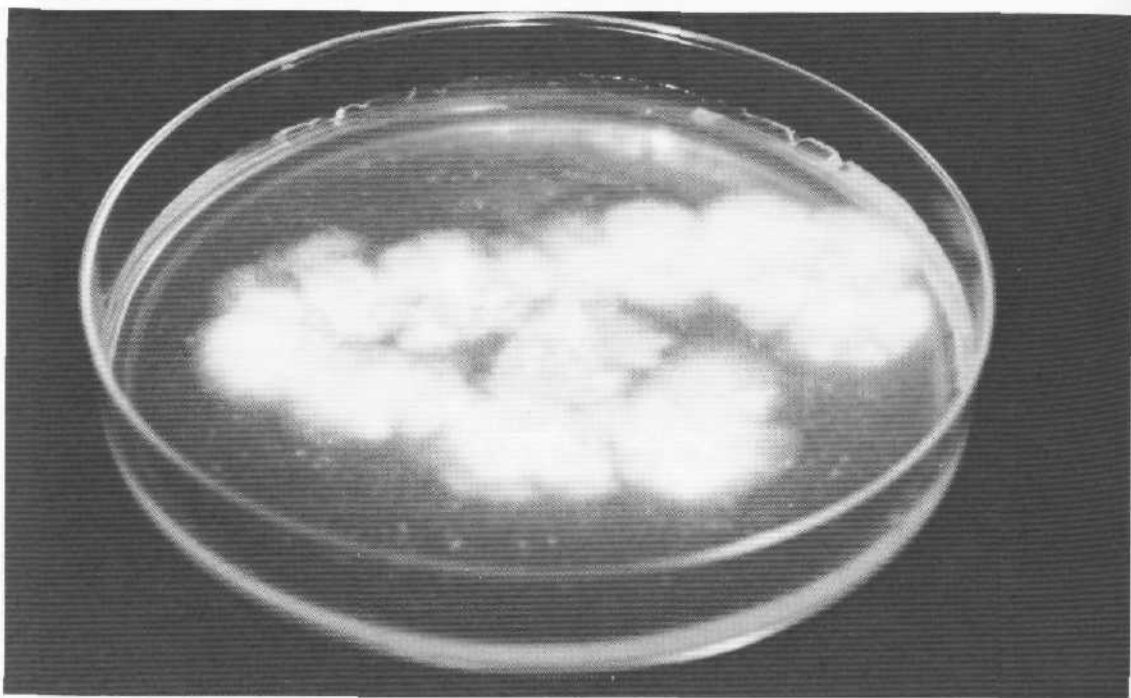

Figure 26 *Stropharia rugoso-annulata* spores germinating.

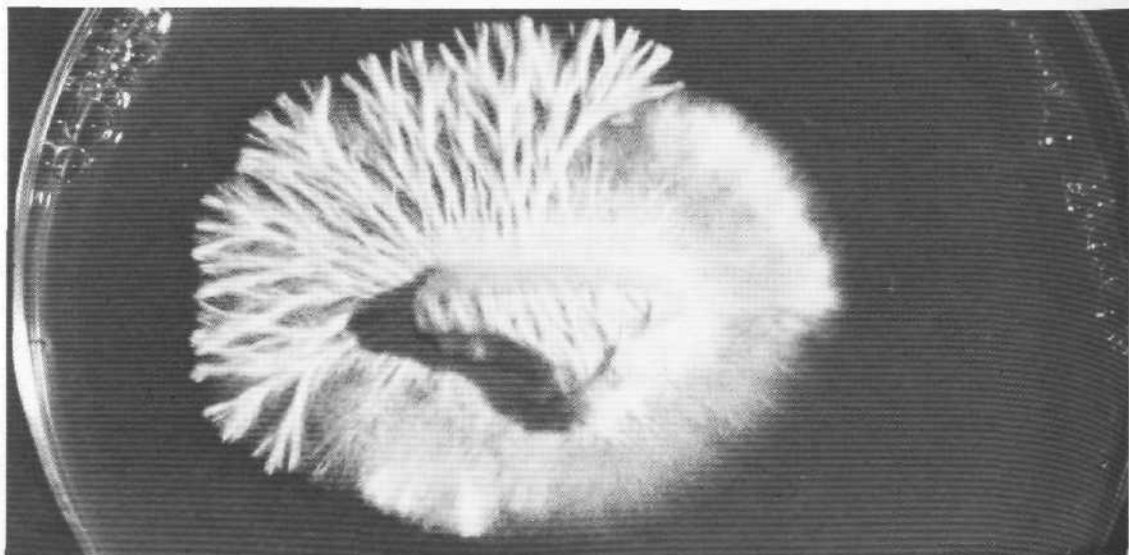

Figure 27 *Psilocybe cubensis* mycelium growing from agar wedge, transferred from a multispore germination. Note two types of mycelial growth.

Cultures from wild specimens may fruit very poorly in an artificial environment. Just as with wild plants, strains of wild mushrooms must be selectively developed.

Of the many newly created strains intrinsic to multispore germination, some may be only capable of vegetative growth. Such mycelia can assimilate nutrients but can not form a mushroom fruit-body (the product of generative growth). A network of cells coming from a single spore is called a monokaryon. As a rule, monokaryons are not capable of producing fertile spore-bearing mushrooms. When two compatible monokaryons encounter one another and mate, cytoplasmic and genetic material is exchanged. The resultant mycelium is a **dikaryon** that can produce fertile offspring in the form of mushrooms. Branching or networking between different dikaryotic strains is known as anastomosis. This process of recombination can occur at any stage of the cultivation process: on agar; on grain; or on bulk substrates. The crossing of different mushroom strains is analogous to the creation of hybrids in horticulture.

Another method for starting cultures is the creation of single spore isolates and is accomplished by diluting spores in a volume of sterile water. This spore solution is further diluted into larger volumes of sterile water which is then used to inoculate media dishes. In this way, cultivators can ob-

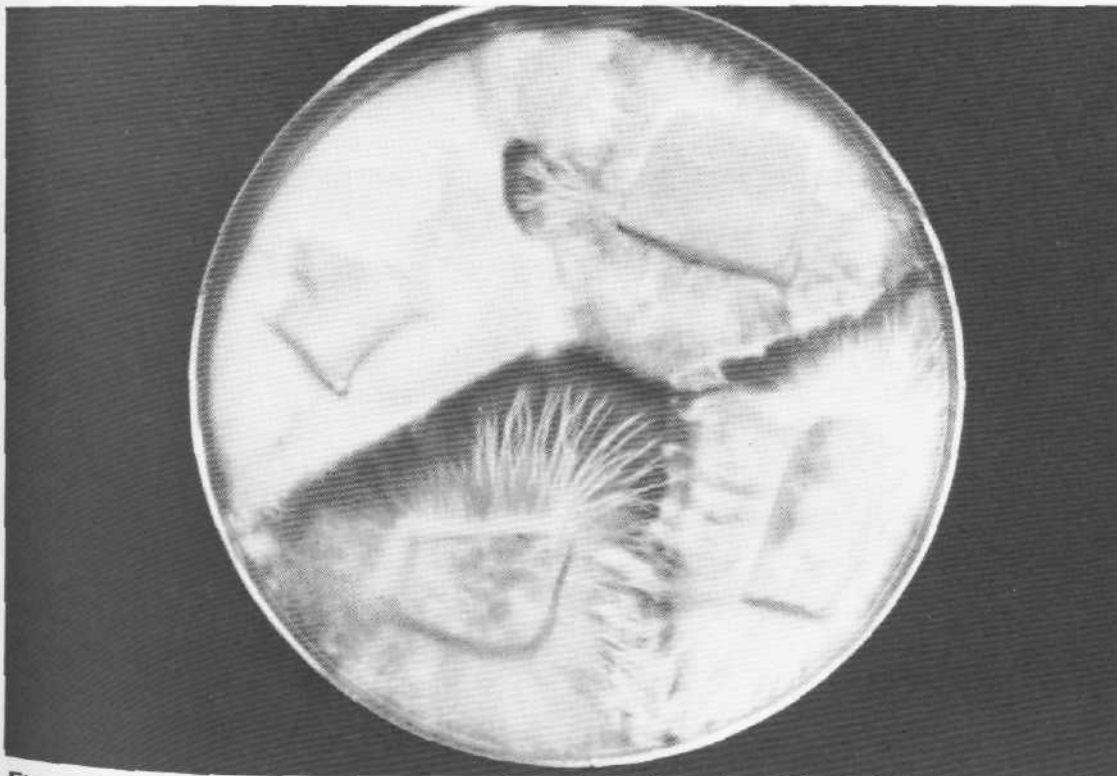

Figure 28 Four strains of *Psilocybe cubensis* mycelium: (clockwise, upper right) Matias Romero; Misantla; Amazonian; and Palenque.

serve individual monokaryons and in a controlled manner institute a mating schedule for the development of high yielding strains. For cultivators interested solely in obtaining a viable culture, this technique is unnecessary and multispore germinations generally suffice. But for those interested in crossing monokaryotic strains and studying mating characteristics, this method is of great value. Keep in mind that for every one hundred spores, only an average of one to five germinate. For a more detailed explanation of strains and strain genetics, see Chapter XV.

The greatest danger of doing concentrated multispore germinations is the increased possibility of contamination, especially from bacteria. Some bacteria parasitize the cell walls of the mycelium, while others stimulate spore germination only to be carried upon and to slowly digest the resulting mycelia. Hence, some strains are inherently unhealthy and tend to be associated with a high percentage of contamination. These infected spores, increase the likelihood of disease spreading to neighboring spores when germination is attempted in such high numbers.

Many fungi, however, have developed a unique symbiotic relationship with other microorganisms. Some bacteria and yeasts actually stimulate spore germination in mushrooms that otherwise are difficult to grow in sterile culture. The spores of *Cantharellus cibarius*, the common and highly prized Chantrelle, do not germinate under artificial conditions, resisting the efforts of world's most experienced mycologists. Recently, Nils Fries (1979), a Swedish mycologist, discovered that when activated charcoal and a red yeast, *Rhodotorula glutinis* (Fres.) Harrison, were added to the media, spore germination soon followed. (Activated charcoal is recommended for any mushroom whose spores do not easily germinate.)

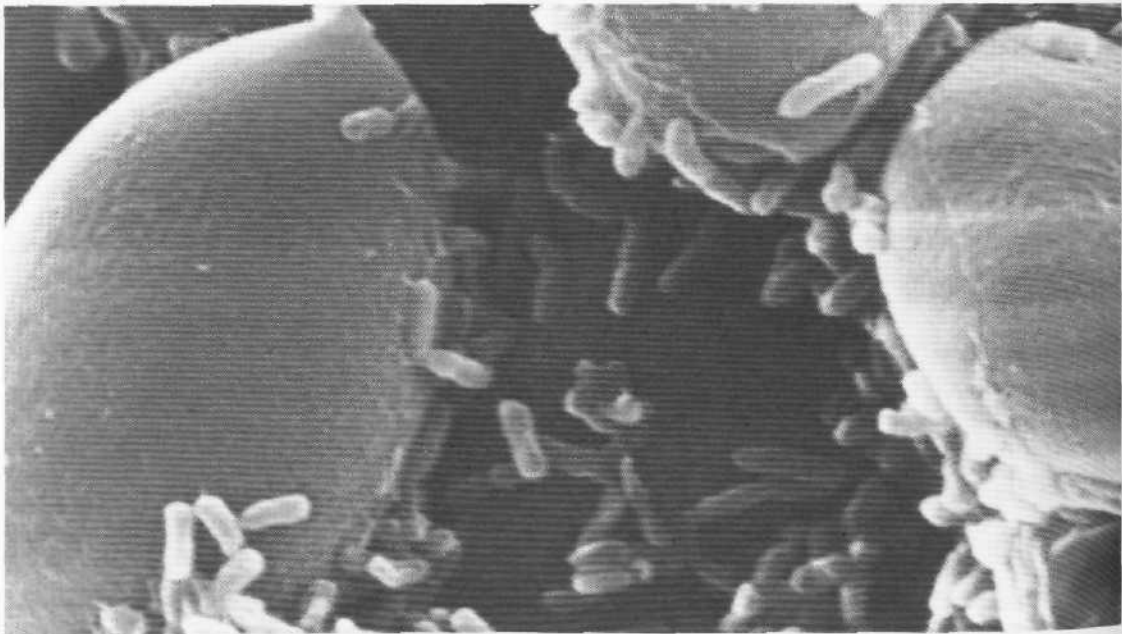

Figure 29 *Psilocybe cubensis* spores infected with rod shaped bacteria.

Many growers have reported that certain cultures flourish when a bacterium accidentally contaminates or is purposely introduced into a culture. *Pseudomonas putida*, *Bacillus megaterium*, *Azotobacter vinelandii* and others have all been shown to have stimulatory effects on various mushroom species—either in the germination of spores, the growth of mycelia or the formation of fruiting bodies (Curtoia and Favelli, 1964). These bacteria are discussed in Appendix III. However, most of the contaminants one encounters in mushroom cultivation, whether they are airborne or intrinsic to the culture, are not helpful. Bacteria can be the most pernicious of all competitors. A diligent regimen of hygiene, the use of high efficiency particulate air (HEPA) filters and good laboratory technique all but eliminate these costly contaminants.

## STARTING A CULTURE FROM LIVE TISSUE

Tissue culture is an assured method of preserving the exact genetic character of a living mushroom. In tissue culture a living specimen is cloned whereas in multisporous culture new strains are created. Tissue cultures must be taken from mushrooms within twenty-four to forty-eight hours of being picked. If the specimens are several days old, too dry or too mature, a pure culture will be difficult to isolate. Spores, on the other hand, can be saved over long periods of time.

Since the entire mushroom is composed of compressed mycelia, a viable culture can be obtained from any part of the mushroom fruitbody. The cap, the upper region of the stem and/or the area where the gill plate joins the underside of the cap are the best locations for excising clean tissue. Some mushrooms have a thick cuticle overlaying the cap. This skin can be peeled back and a tissue culture can be taken from the flesh underlying it. Wipe the surface of the mushroom with a cotton swab soaked in alcohol and remove any dirt or damaged external tissue. Break the mushroom cap or stem, exposing the interior hyphae. Immediately flame a scalpel until red-hot and cool in a media filled petri dish. Now cut into the flesh removing a small fragment of tissue. Transfer the tissue fragment to the center of the nutrient filled petri dish as quickly as possible, exposing the tissue and agar to the open air for a minimal time. Repeat this technique into at least three, preferably five more dishes. Label each dish with the species, date, type of culture (tissue) and kind of agar medium. If successful, mycelial growth will be evident in three to seven days.

An overall contamination rate of a 10% is one most cultivators can tolerate. In primary cultures however, especially those isolated from wild specimens, it is not unusual to have a 25% contamination rate. Diverse and colorful contaminants often appear near to the point of transfer. Their numbers depend on the cleanliness of the tissue or spores transferred and the hygienic state of the laboratory where the transfers were conducted. In tissue culture, the most commonly encountered contaminants are bacteria.

Contamination is a fact of life for every cultivator. Contaminants become a problem when their populations spiral above tolerable levels, an indication of impending disaster in the laboratory. If a five, ten or fifteen percent contamination rate is normal for a cultivator and suddenly the contamination level escalates without an alteration of regimen, then new measures of control should be introduced.



Figure 30 Splitting the mushroom stem to expose interior tissue.

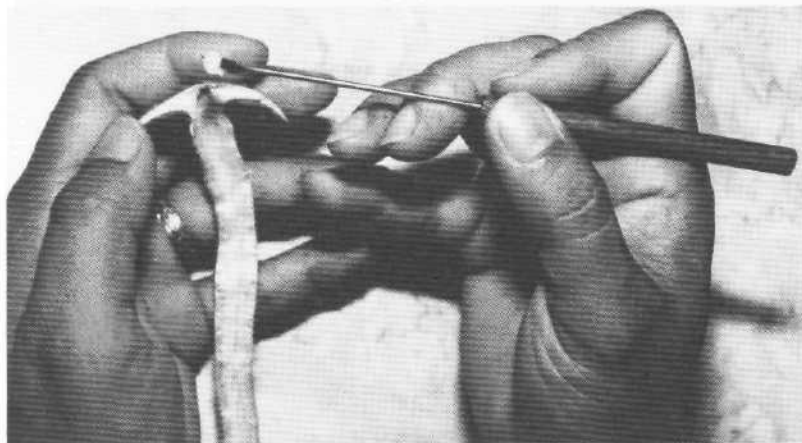

Figure 31 Cutting into mushroom flesh with a cooled, flame sterilized scalpel.

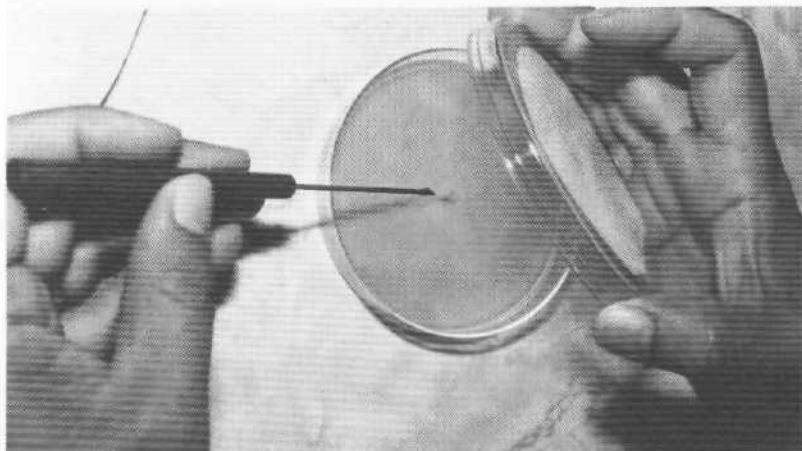

Figure 32 Excising a piece of tissue for transfer into a petri dish.



Once the tissue shows signs of growth, it should be transferred to yet another media dish. If no signs of contamination are evident, early transfer is not critical. If sporulating colonies of mold develop adjacent to the growing mycelium, the culture should be promptly isolated. Continue transferring the mycelium away from the contaminants until a pure strain is established. Obviously, isolating mycelia from a partially contaminated culture is more difficult than transferring from a pure one. The mere attempt of isolating mycelia away from a nearby contaminant is fraught with the danger of spreading its spores. Although undetectable to us, when the rim of a petri dish is lifted external air rapidly enters and spores become airborne. Therefore, the sooner the cultivator is no longer dependent upon a partially contaminated culture dish, the easier it will be to maintain pure cultures. Keep in mind that a strain isolated from a contaminated media dish can harbor spores although to the unaided eye the culture may appear pure. Only when this contaminant laden mycelium is inoculated into sterile grain will these inherent bacteria and molds become evident.

To minimize contamination in the laboratory there are many measures one can undertake. The physical ones such as the use of HEPA filters, asperated oil and glove boxes have already been discussed. One's attitude towards contamination and cleanliness is perhaps more important than the installation of any piece of equipment. The authors have seen laboratories with high contamination rates and closets that have had very little. Here are two general guidelines that should help many first-time cultivators.

1. Give the first attempt at sterile culture the best effort. Everything should be clean: the lab; clothes; tools; and especially the cultivator.
2. Once a pure culture has been established, make every attempt to preserve its purity. Save only the cultures that show no signs of mold and bacteria. Throw away all contaminated dishes, even though they may only be partially infected.

If failure greets one's first attempts at mushroom culture, do not despair. Only through practice and experience will sterile culture techniques become fluent.

Agar culture is but one in a series of steps in the cultivation of mushrooms. By itself, agar media is impractical for the production of mushrooms. The advantage of its use in mushroom culture is that mycelial mass can be rapidly multiplied using the smallest fragments of tissue. Since contaminants can be readily observed on the flat two dimensional surface of a media filled petri dish, it is fairly easy to recognize and maintain pure cultures.

## SECTORING: STRAIN SELECTION AND DEVELOPMENT

As mycelium grows out on a nutrient agar, it can display a remarkable diversity of forms. Some mycelia are fairly uniform in appearance; others can be polymorphous at first and then suddenly develop into a homogeneous looking mycelia. This is the nature of mushroom mycelia—to constantly and evolve.

When a mycelium grows from a single inoculation site and several divergent types appear, it is



Figure 33 **Bacteria** growing from contaminated mushroom mycelium.

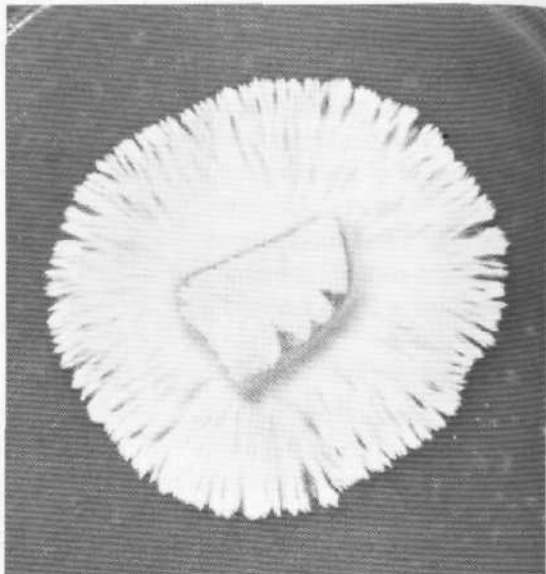

Figure 34 **Rhizomorphic mycelium.** Note divergent ropey strands.

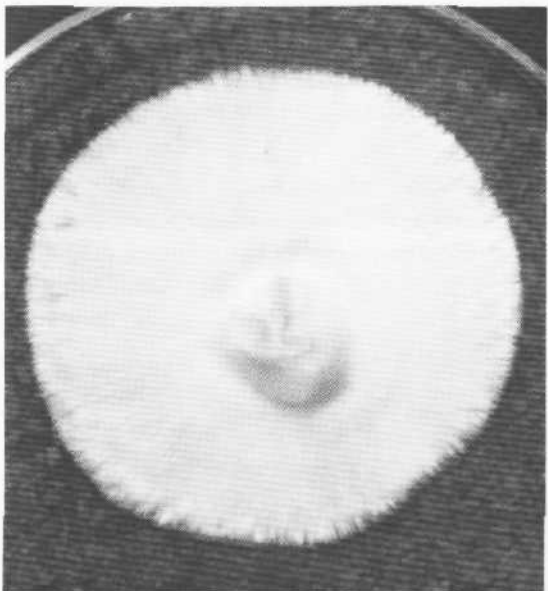

Figure 35 **Intermediate linear type mycelium.** Note longitudinally radial fine strands (*Psilocybe cyanescens* mycelium).

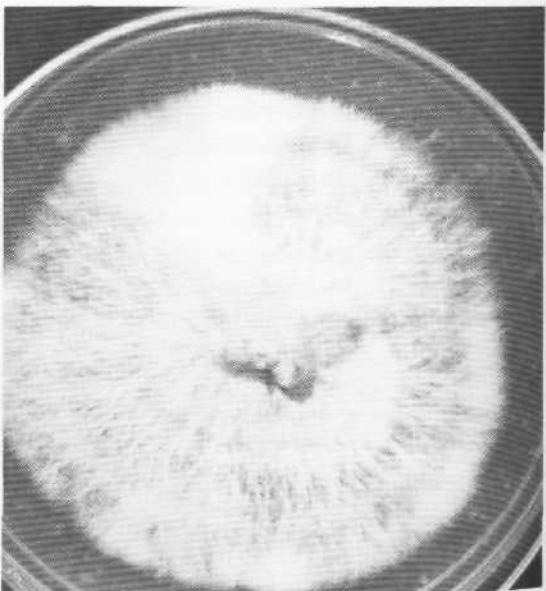

Figure 36 **Rhizomorphic mycelia with tomentose (cottony) sector** (of *Agaricus brunnescens*).

said to be **sectoring**. A sector is defined solely in contrast to the surrounding, predominant mycelia. There are two major classes of mycelial sectors: rhizomorphic (strandy) and tomentose (cottony). Also, an intermediate type of mycelium occurs which grows linearly (longitudinally radial) but does not have twisted strands of interwoven hyphae that characterize the rhizomorphic kind. Rhizomorphic mycelium is more apt to produce primordia. Linear mycelium can also produce abundant primordia but this usually occurs soon after it forms rhizomorphs. Keep in mind, however, that characteristics of fruiting mycelium are often species specific and may not conform precisely to the categories outlined here.

In a dish that is largely covered with a cottony mycelia, a fan of strandy mycelia would be called a rhizomorphic sector, and vice versa. Sectors are common in mushroom culture and although little is known as to their cause or function, it is clear that genetics, nutrition and age of the mycelium play important roles.

According to Stoller (1962) the growth of fluffy sectors is encouraged by broken and exploded kernels which increase the availability of starch in the spawn media. Working with *Agaricus brunnescens*, Stoller noted that although mycelial growth is faster at high pH levels (7.5) than at slightly acid pH levels (6.5), sectoring is more frequent. He found that sectors on grain could be re-



Figure 37 *Psilocybe cubensis* mycelia with cottony and rhizomorphic sectors. Note that primordia form abundantly on rhizomorphic mycelium but not on the cottony type.



Figure 38 Hyphal aggregates of *Agaricus bitorquis* forming on malt agar media.



Figure 39 Primordia of *Psilocybe cubensis* forming on malt agar media.

duced by avoiding exploded grains (a consequence of excessive water) and buffering the pH to 6.5 using a combination of chalk (precipitated calcium carbonate) and gypsum (calcium sulfate).

Commercial *Agaricus* cultivators have long noted that the slower growing cottony mycelium is inferior to the faster growing rhizomorphic mycelium. There is an apparent correlation between cottony mycelia on agar and the later occurrence of "stroma", a dense mat-like growth of mycelia on the casing which rarely produces mushrooms. Furthermore, primordia frequently form along generatively oriented rhizomorphs but rarely on somatically disposed cottony mycelia. It is of interest to mention that, under a microscope, the hyphae of a rhizomorphic mycelial network are larger and branch less frequently than those of the cottony network.

Rhizomorphic mycelia run faster, form more primordia and in the final analysis yield more mushrooms than cottony mycelia. One example of this is illustrated in Fig. 37. A single wedge of mycelium was transferred to a petri dish and two distinct mycelial types grew from it. The stringy sector formed abundant primordia while the cottony sector did not, an event common in agar culture.

When a mycelium grows old it is said to be senescing. Senescent mycelium, like any aged plant or animal, is far less vigorous and fertile than its counterpart. In general, a change from rhizomorphic to cottony looking mycelium should be a warning that strain degeneration has begun.

If at first a culture is predominantly rhizomorphic, and then it begins to sector, there are several measures that can be undertaken to promote rhizomorphism and prevent the strain's degeneration.

1. Propagate only rhizomorphic sectors and avoid cottony ones.
2. Alter the media regularly using the formulas described herein. Growing a strain on the same agar formula is not recommended because the nutritional composition of the medium exerts an selective influence on the ability of the mushroom mycelium To produce digestive enzymes. By varying the media, the strain's enzyme system remains broadly based and the mycelium is better suited for survival. Species vary greatly in their preferences. Unless specific data is available, trial and error is the only recourse.
3. Only grow out the amount of mycelium needed for spawn production and return the strain to storage when not in use. Do not expect mycelium that has been grown over several years at optimum temperatures to resemble the primary culture from which it came. After so many cell divisions and continual transfers, a sub-strain is likely to have been selected out, one that may distantly resemble the original in both vitality, mycelial appearance and fruiting potential.
4. If efforts to preserve a vital strain fail, re-isolate new substrains from multispore germinations.
5. Another alternative is to continuously experiment with the creation of hybrid strains that are formed from the mating of dikaryotic mycelia of Two genetically distinct parents. (experiments with *Agaricus brunnescens* have shown, however, that most hybrids yield less than both or one of the contributing strains. A minority of the hybrids resulted in more roductive strains.)

Home cultivators can selectively develop mushroom strains by rating mycelia according to several characteristics. These characteristics are:

1. Rhizomorphism—fast growing vegetative mycelium.
2. Purity of the strain—lack of cottony sectors.
3. Cleanliness of the mycelia—lack of associated competitor organisms (bacteria, molds and mites).
4. Response time to primordia formation conditions.
5. Number of primordia formed.
6. Proportion of primordia formed that grow to maturity.
7. Size, shape and/or color of fruitbodies.
8. Total yield.
9. Disease resistance.
10. CO<sub>2</sub> tolerance/sensitivity.
11. Temperature limits.
12. Ease of harvesting.

Using these characteristics, mushroom breeders can qualitatively judge strains and select ones over a period of time according to how well they conform to a grower's preferences.



**Figure 40** Mature stand of *Psilocybe cubensis* on malt agar media.

## STOCK CULTURES: METHODS FOR PRESERVING MUSHROOM STRAINS

Once a pure strain has been created and isolated, saving it in the form of a "stock culture" is wico Stock cultures—or "slants" as they are commonly called—are media filled glass test tubes which are sterilized and then inoculated with mushroom mycelium. A suitable size for a culture tube w. is 20 mm x 100 mm. with a screw cap. Every experienced cultivator maintains a collection of stock cultures known as a "species bank". The species bank is an integral part of the cultivation process. With it, a cultivator may preserve strains for years.

To prepare slants, first mix any of the agar media formulas discussed earlier in this chapter. Fill test tubes one third of the way, plug with cotton and cover with aluminum foil or simply screw on the cap if the tubes are of this type. Sterilize in a pressure cooker for 30 minutes at 15 psi. Allow the cooker to return to atmospheric pressure and then take it into the sterile room before opening. Remove the slants, gently shake them to distribute the liquified media and lay them at a 15-30 degree angle to cool and solidify.

When ready, inoculate the slants with a fragment of mushroom mycelium. Label each tube with the date, type of agar, species and strain. Make at least three slants per strain to insure against loss. Incubate for one week at 75 ° F. (24 ° C.). Once the mycelia has covered a major portion of the agar's surface and appears to be free of contamination, store at 35-40 ° F. (2-4 ° C.). At these temperatures, the metabolic activity of most mycelia is lowered to a level where growth and nutrient absorption virtually stops. Ideally one should check the vitality of stored cultures every six months by removing fragments of mycelium and inoculating more petri dishes. Once the mycelium has colonized two-thirds of the media dish, select for strandy growth (rhizomorphism) and reinoculate more slants. Label and store until needed. Often, growing out minicultures is a good way to check a stored strain's vitality and fruiting ability.

An excellent method to save cultures is by the buddy system: passing duplicates of each species or of strains to a cultivator friend. Mushroom strains are more easily lost than one might expect. Once lost, they may never be recovered.

In most cases, the method described above safely preserves cultures. Avid cultivators, however, can easily acquire fifty to a hundred strains and having to regularly revitalize them becomes tedious and time consuming. When a library of cultures has expanded to this point, there are several additional measures that further extend the life span of stock cultures.

A simple method for preserving cultures over long periods of time calls for the application of a thin layer of sterile mineral oil over the live mycelium once it has been established in a test tube. The oil is non-toxic to the mycelium, greatly reduces the mycelium's metabolism and inhibits water evaporation from the agar base. The culture is then stored at 37-41 ° F. until needed. In a recent study (Perrin, 1979), all of the 30 wood inhabiting species stored under mineral oil for 27 years produced a viable culture. To reactivate the strains, slants were first inverted upside down so the oil would drain off and then incubated at 77 ° F. Within three weeks each slant showed renewed signs of growth and when subcultured onto agar plates they yielded uncontaminated cultures.



Figure 41 Filling test tubes with liquid agar media prior to sterilization in a pressure cooker.

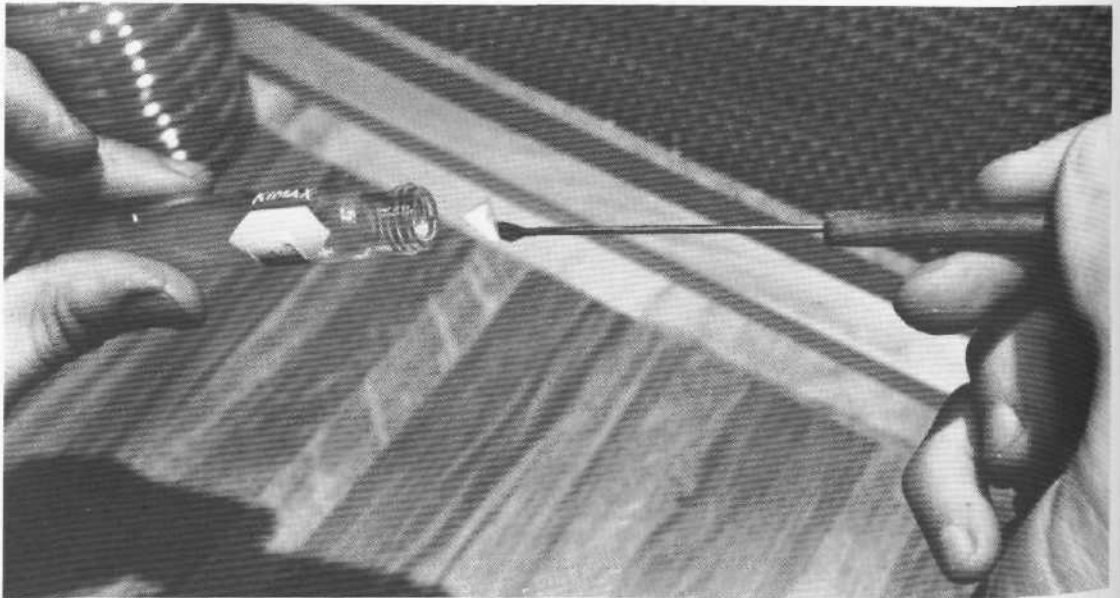

Figure 42 Inoculating a test tube slant with a piece of mycelium.



Although a strain may be preserved over the long term using this method, will it be as productive as when it was first stored? Other studies have concluded that strains saved for more than 5 years under mineral oil showed distinct signs of degeneration while these same strains were just as productive at 2½ years as the day they were preserved. Nevertheless, it is not unreasonable to resume, based on these studies, that cultures can be stored up to two years without serious impairment to their vitality.

Four other methods of preservation include: the immersion of slants into liquid nitrogen (an expensive procedure); the inoculation of washed sterilized horse manure/straw compost that is then kept at 36-38 ° F. (See Chapter V on compost preparation); the inoculation of sawdust/bran media for wood decomposers (see section in Chapter III on alternative spawn media); or saving spores aseptically under refrigerated conditions—perhaps the simplest method for home cultivators.

Whatever method is used, remember that the mushroom's nature is to fruit, sporulate and evolve. Cultivation techniques should evolve with the mushroom and the cultivator must selectively isolate and maintain promising strains as they develop. So don't be too surprised if five years down the line a stored strain poorly resembles the original in its fruiting potential or form.

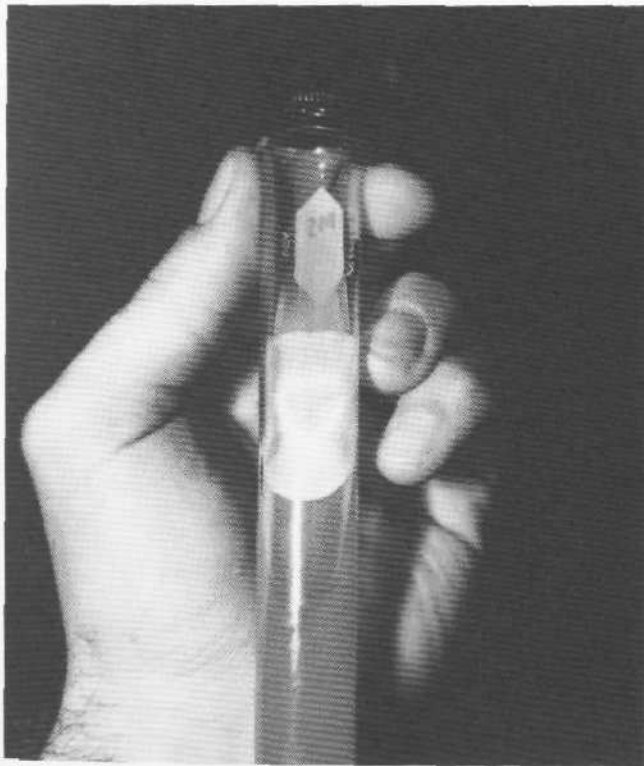

**Figure 43** Culture slant of healthy mycelium ready for cool storage.

## CHAPTER III GRAIN CULTURE

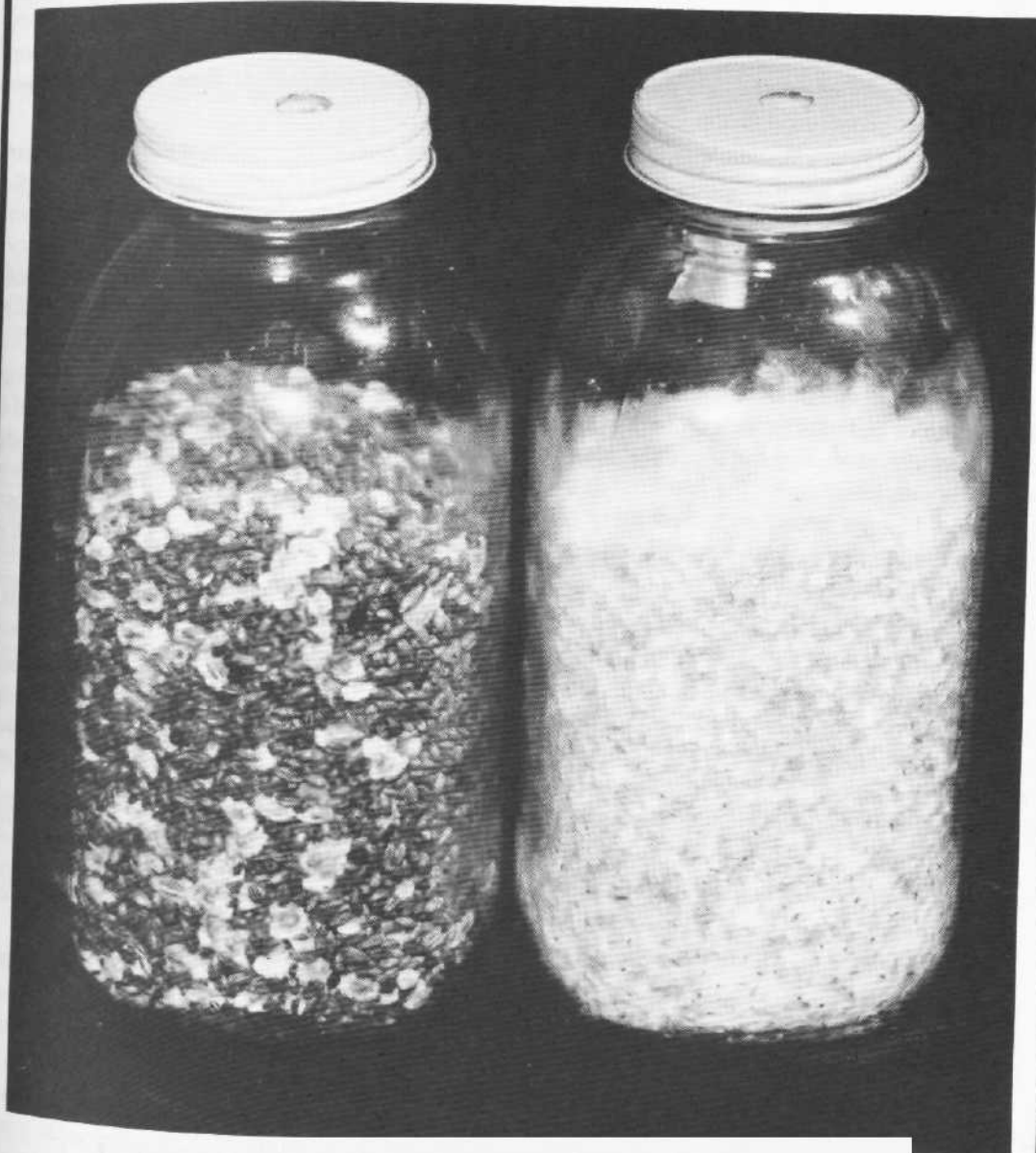

Figure 44 Half gallon spawn jars at 3 and 8 days after inoculation.

## THE DEVELOPMENT OF GRAIN SPAWN

**M**ushroom spawn is used to inoculate prepared substrates. This inoculum consists of a carrier material fully colonized by mushroom mycelium. The type of carrier varies according to the mushroom species cultivated, although rye grain is the choice of most spawn makers. The history of the development of mushroom spawn for *Agaricus brunnescens* culture illustrates how spawn production has progressed in the last hundred years.

During the 1800's *Agaricus* growers obtained spawn by gathering concentrations of mycelium from its natural habitat. To further encourage mycelial growth this "virgin spawn" was supplemented with materials similar to those occurring naturally, in this case horse manure. Spent compost from prior crops was also used as spawn. This kind of spawn, however, contained many contaminants and pests, and yielded few mushrooms. Before serious commercial cultivation could begin, methods guaranteeing the quality and mass production of the mushroom mycelium had to be developed.

With the advent of pure culture techniques, propagation of mushroom mycelium by spore germination or by living tissue completely superseded virgin spawn. Now the grower was assured of not only a clean inoculum but also a degree of certainty as to the strain itself. Strain selection and development was possible for the first time in the history of mushroom culture because high yielding strains could be preserved on a medium of precise composition. Sterilized, chopped, washed compost became the preferred medium for original pure culture spawn and was for years the standard of the *Agaricus* industry.

In 1932, Dr. James Sinden patented a new spawn making process using cereal grain as the mycelial carrier. Since then rye has been the most common grain employed although millet, milo and wheat have also been used. Sinden's novel approach set a new standard for spawn making and forms the basis for most modern spawn production. The distinct advantage of grain spawn is the increased number of inoculation sites. Each individual kernel becomes one such point from which mycelium can spread. Thus, a liter of rye grain spawn that contains approximately 25,000 kernels represents a vast improvement over inocula transmitted by coarser materials.

Listed below are cereal grains that can be used to produce spawn. Immediately following this list is a chart illustrating some of the physical properties important to the spawn maker.

**RICE:** Utilized by few cultivators. Even when it is balanced to recommended moisture levels, the kernels tend to clump together owing to the sticky nature of the outer coat.

**MILLET:** Although having a higher number of inoculation points than rye, it is more difficult to formulate as spawn. Amycel, a commercial spawn-making company, has successfully developed a formula and process utilizing millet as their primary spawn medium.

**SORGHUM:** Has spherical kernels and works relatively well as a spawn medium but it can be difficult to obtain. Milo, a type of sorghum, has been used for years by the Stoller Spawn Company.

**WHEAT:** Works equally well as rye for spawn making and fruitbody production.

**WHEAT GRASS and RYE GRASS SEED:** Both have many more kernels per gram than arain. The disadvantage of seed is the tendency to lose its moisture and its inability to separate into individual kernels, making it difficult to shake. (Rye grass and wheat grass seed are widely used to promote sclerotia formation in *Psilocybe tampanensis*, *Psilocybe mexicana* and *Psilocybe armandii*. Perennial or annual can be used although annual is far cheaper. See the species parameters for these species in Chapter XI.)

**RYE:** Its availability, low cost and ability to separate into individual kernels are all features recommending its use as a spawn and fruiting medium.

### THE CEREAL GRAINS AND THEIR PHYSICAL PROPERTIES

(Tests run by the authors)

TYPE	KERNELS/GRAM	GRAMS/100	ML	% MOISTURE
COMMERCIAL FEED RYE	30	75		15%
COMMERCIAL MUSHROOM RYE	40	72		13%
ORGANIC CO-OP RYE	55	76		11%
ORGANIC WHEAT	34	90		10%
SHORT GRAIN BROWN RICE	39	100		26%
LONG GRAIN BROWN RICE	45	86		15%
SORGHUM (MILO)	33	93		15%
PERENNIAL WHEAT GRASS SEED	450	43		16%
PERENNIAL RYE GRASS SEED	415	39		12%
MILLET	166	83		13%

In a single gram of commercial rye, *Secale cereale*, there is an estimated cell count of 50,000-100,000 bacteria, more than 200,000 actinomycetes, 12,000 fungi and a large number of yeasts. To sterilize one gram of grain would require, in effect, the destruction of more than 300,000 of grain, and with the addition of water, the cell population soars to astronomical figures. One gram of grain of spawn, if it contains one percent of the above organisms, contains 50,000-100,000 bacteria, 200,000 actinomycetes, 12,000 fungi and a large number of yeasts.

Of all the groups of these organisms, bacteria are the most pernicious. Bacteria can divide every twenty or so minutes at room temperature. At this rate, a single bacterium multiplies into

more than a million cells in less than ten hours. In another ten hours, each one of these bacteria beget another million cells. If only a small fraction of one percent of these contaminants survive the sterilization process, they can render grain spawn useless within only a few days.

Most microorganisms are killed in the sterilization process. For liquids, the standard time and pressure for steam sterilization is 25 minutes at 15 psi (250 ° F). For solids such as rye, the sterilization time must be increased to insure that the steam sufficiently penetrates the small air pockets and structural cavities in the grain. Within these cavities bacteria and other thermo-resistant organisms, partially protected from the effects of steam, have a better chance of enduring a shorter sterilization period than a longer one. Hence, a full hour at 15 psi is The minimum time recommended to sterilize jars of rye grain.

Some shipments of grain contain extraordinarily high levels of bacteria and fungi. Correspondingly the contamination rate on these grains are higher, even after autoclaving and prior to inoculation. Such grain should be discarded outright and replaced with grain of known quality.

Once the grain has been sterilized, it is presumed all competitors have been neutralized, The next most probable source of contamination is the air immediately surrounding the jars. As hot jars cool, they suck in air along with airborne contaminants. If the external spore load is excessively high, many of these contaminants will be introduced into the grain even before conducting a single inoculation! In an average room, there are 10,000 particulates exceeding .3 microns (dust, spores, etc.) per cubic foot while in a "sterile" laboratory there are less than 100 per cubic foot. With these facts in mind, two procedures will lessen the chance of contamination after the spawn jars have been autoclaved.

1. If autoclaving grain media outside The laboratory in an unsterile environment (a kitchen, for instance), be sure to clean the outside of the pressure cooker before bringing it into the sterile inoculating room.
2. Inoculate the jars as soon as they have cooled to room temperature. Although many cultivators leave uninoculated jars sitting in pressure cookers overnight, this is not recommended.

The amount of water added to the grain is an important factor contributing to the reproduction of contaminants. Excessive water in a spawn jar favors the growth of bacteria and other competitors. In wet grain the mushroom mycelium grows denser and slower. Oversaturated grain kernels explode during the sterilization process, and with their interiors exposed, the grain is even more susceptible to contamination. In addition, wet grain permeated with mycelium is difficult to break up into individual kernels. When such grain comes in contact with a non-sterile medium such as casing soil or compost, it frequently becomes contaminated. Spawn made with a balanced moisture content has none of these problems. It easily breaks apart into individual mycelium covered kernels, insuring a maximum number of inoculation points from which mycelial strands can emerge.

Determining the exact moisture content of grain is not difficult. Once done, the cultivator can easily calculate a specific moisture content that is optimal for use as spawn. Commercial rye grain, available through co-ops and feed companies, is 11 % water by mass, plus or minus 2%. The precise amount of water locked up in grain can be determined by weighing a sample of 100 grams.

---

Then reweigh the same grain after it has been dried in an oven (250° F. for 3 hours) and subtract this new weight from the original 100 grams. The resultant figure is the percentage of moisture naturally bound within the grain.

## PREPARATION OF GRAIN SPAWN

The optimum moisture content for grain in the production of spawn is between 49-54%. The following formulas are based on cereal rye grain, *Secale cereale*, which usually has a moisture content of 11%. Some variation should be expected depending on the brand, kernel size, geographical origin and the way the grain has been stored.

The standard spawn container for the home cultivator is the quart mason jar while the commercial spawn maker prefers the gallon jar. Wide mouth mason jars have been extensively used by home cultivators because of several books popularizing fruitbody production in these jars. Wide mouth jars have been preferred because mushrooms grown in them are easier to harvest than those in narrow mouth ones. Not only is this method of growing mushrooms outdated, but wide mouth jars have several disadvantages for spawn production and hence are not recommended. Narrow mouthed containers have less chance of contaminating from airborne spores because of their smaller openings and are more suited to use with synthetic filter discs. The purpose of the spawn container is to temporarily house the incubating mycelium before it is laid out in trays or used to inoculate bulk substrates. Jars are not well suited as a fruiting container.

Most commercial spawn makers cap their spawn bottles with synthetic filter discs which allow air penetration and gaseous exchange but not the free passage of contaminating spores. Home cultivators, on the other hand, have used inverted mason lids which imperfectly seal and allow some



Figure 16.45. The grain media, before and after autoclaving using the above formulas.

air exchange. This method works fine under sterile conditions although the degree of filtration is not guaranteed. The best combination uses filter discs in conjunction with one piece screw top lids having a 3/8-1/2 inch diameter hole drilled into its center and fitting a narrow mouthed autoclavable container. The authors personally find the regular mouthed 1/2 gallon mason jar to be ideal. (Note: These 1/2 gallon jars are inoculated from quart masters, a technique soon to be discussed). Using only filter discs on wide mouth jars is not recommended due to the excessive evaporation from the grain medium.

To produce grain spawn of 48-52% moisture use the formulas outlined below and autoclave in a pressure cooker for 1 hour at 15-18 psi. Note that considerable variation exists between measuring cups, differing as much as 10% in their volumes. Check the measuring cup with a graduated cylinder. Once standardized, fashion a "grain scoop" and a "water scoop" from a plastic container to the proportions specified below.

### Spawn Formulas

#### QUART JARS

1 cup rye grain  
2/3-3/4 cup water

240 ml. grain  
170-200 ml.

#### 1/2 GALLON JARS

3 cups rye grain  
1 3/4 cups water

or  
(approximately)

600 ml. rye grain  
water 400-460 ml. water

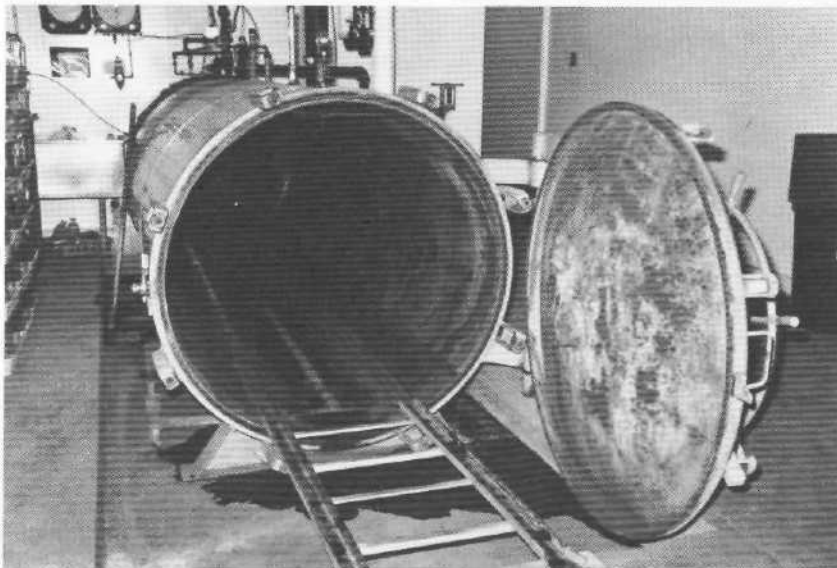

**Figure 46**  
Commercial spawn  
maker's autoclave.



**Figure 47** Pressure cooker of home cultivator.

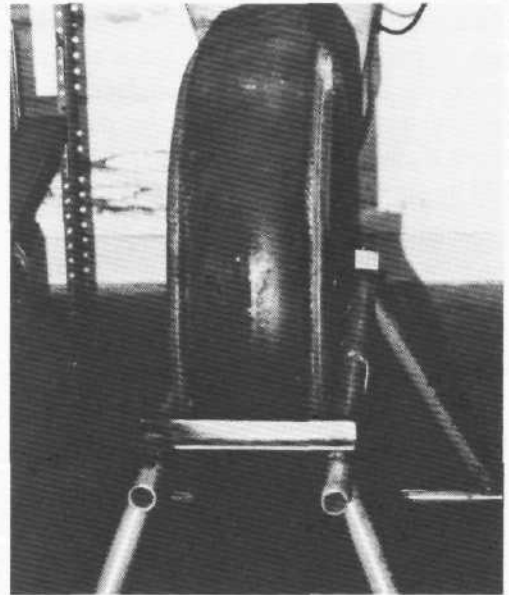

**Figure 48** The rubber tire is a helpful tool for the spawn laboratory. It is used to loosen grain spawn.

The above formulas fill a quart or a half gallon jar to nearly  $\frac{2}{3}$  of its capacity after autoclaving. In all these formulas, chalk ( $\text{CaCO}_3$ ) and gypsum ( $\text{CaSO}_4$ ) can be added at a rate of 1-3 parts by weight per 100 parts of grain (dry weight). The ratio of chalk to gypsum is 1:4. The addition of these elements to spawn is optional for most species but necessary when growing *Agaricus brunnescens*. When these calcium buffers are used, add 10% more water than that listed above.

Once the grain filled jars have been autoclaved, they should be placed in the sterile room and allowed to cool. Prior to this point, the room and its air should be disinfected, either through the use of traditional cleaning methods, HEPA filters or both.

Upon removing the warm jars from the pressure cooker or autoclave, shake them to loosen the grain and to evenly distribute wet and dry kernels. Shaking also prevents the kernels at the bottom of the jar from clumping.

An excellent tool to help in this procedure is a bald car tire or padded chair. Having been carefully cleaned and disinfected, the tire should be mounted in an upright and stable position. The tire has a perfect surface against which to shake the jars, minimizing discomfort to the hands and reducing the risk of injury from breakage. The tire will be used at another stage in grain culture, so it should be cleaned regularly. Paint shakers are employed by commercial spawn makers for this same purpose but they are inappropriate for the home cultivator. **CAUTION: ALWAYS INSPECT JARS FOR CRACKS BEFORE SHAKING.**

When the grain jars have returned to room temperature, agar to grain inoculations can com-



mence. Once again, good hygiene is of the utmost importance. When transferring mycelium from agar to grain, another dimension is added in which contaminants can replicate. In agar culture, the mycelium grows over a flat, two dimensional surface. If contamination is present, it is easily seen. In grain culture, however, the added dimension of depth comes into play and contaminants become more elusive, often escaping detection from the most discerning eye. If not noticed, contamination will be spread when this spawn is used to inoculate more sterilized grain.

Before conducting transfers, take precautions to insure the sterile quality of the inoculation environment. After cleaning the room, do not jeopardize its cleanliness by wearing soiled clothes. Few cultivators take into consideration that they are a major source of contamination. In fact, the human body is in itself a habitat crawling with bacteria, microscopic mites, and resplendent with spores of plants and fungi.

When satisfied that all these preparatory conditions are in force, the making of spawn can begin.

### **Inoculation of Sterilized Grain from Agar Media**

Select a vigorously growing culture whose mycelium covers no more than  $\frac{3}{4}$  of the agar's surface. Cultures that have entirely overrun the petri dish should be avoided because contaminants often enter along the margin of the petri dish. If that outer edge is grown over with mycelium, these invaders can go undetected. Since this peripheral mycelium can become laden with contaminant spores, any grain inoculated with it would become spoiled.

Flame sterilize a scalpel and cut out a triangular wedge of mycelium covered agar using the technique described for doing agar-to-agar transfers. With careful, deliberate movements quickly transfer the wedge to an awaiting jar, exposing the grain for a minimal amount of time. For each transfer, flame sterilize the scalpel and inoculate wedges of mycelium into as many jars as desired. A petri dish two thirds covered with mycelium should amply inoculate 6-8 quart jars of grain. (A maximum of 10-12 jars is possible). The more mycelia transferred, the faster the colonization and the less chance of contamination. Since these jars become the "master cultures", do everything possible to guarantee the highest standard of purity.

The authors recommend a "double wedge" transfer technique whereby a single triangular wedge of mycelium is cut in half, both pieces are speared and then inserted into an awaiting jar of sterilized grain. Jars inoculated with this method grow out far faster than the single wedge transfer technique.

Loosening the lids prior to inoculation facilitates speedy transfers. As each agar-to-grain transfer is completed, replace the lid and continue to the next inoculation. Once the set is finished, tightly secure the lids and shake each jar thoroughly to evenly distribute the mycelial wedges. In the course of shaking, each wedge travels throughout the grain media leaving mycelial fragments adhering to grain kernels. If a wedge sticks to the glass, distribution is hampered and spawn running is inhibited. This problem is usually an indication of agar media that has been too thinly poured or has been allowed to dehydrate. Once shaken, incubate the spawn jars at The appropriate temperature. (A second shaking may be necessary on Day 4 or Day 5). In general, the grain should be fully colonized with mycelium in seven to ten days.

---

## Inoculation of Grain from Grain Masters

Once fully colonized, these grain masters are now used for the further production of grain spawn in quart or 1/2 gallon containers. Masters must be transferred within a few days of their full colonization otherwise the myceliated kernels do not break apart easily. A step by step description of the grain to-grain transfer technique follows.

1. Carefully scrutinize each jar for any signs of contamination. Look for such abnormalities as: heavy growth; regions of sparse, inhibited growth; slimy or wet looking kernels (an indication of bacteria); exploded kernels with pallid, irregular margins; and any unusual colorations. If in doubt lift the lid and smell the spawn—a sour "rotten apple" or otherwise pungent odor is usually an indication of contamination by bacteria. Jars having this scent should be discarded. (Sometimes spawn partially contaminated with bacteria can be cased and fruited). Do NOT use any jar with a suspect appearance for subsequent inoculations.
2. After choosing the best looking spawn masters, break up the grain in each jar by shaking the jars against a tire or slamming them against the palm of the hand. The grain should break easily into individual kernels. Shake as many masters as needed knowing that each jar can amply inoculate ten to twelve quart jars or seven to nine half gallon jars.

Once completed, SET THE SPAWN JARS ON A SEPARATE SHELF AND WAIT TWELVE TO TWENTY-FOUR HOURS BEFORE USING. This waiting period is important because some of the spawn may not recover, suffering usually from bacterial contamination. Had these jars been used, the contamination rate would have been multiplied by a factor of ten.

3. Inspect the jars again for signs of contamination. After twelve to twenty-four hours, the mycelium shows signs of renewed growth.
4. If the masters had been shaken the night before, the inoculations can begin the following morning or as soon as the receiving jars (G-2) have cooled. Again, wash the lab, be personally clean and wear newly laundered clothes.

Place 10 sterilized grain-filled jars on the work-bench in the sterile room. Loosen each of the lids so they can be removed with one hand. Gently shake the master jar until the grain spawn separates into individual kernels. Hold the master in your preferred hand. Remove the master's lid and then with the other hand open the first jar to be inoculated. With a rolling of the wrist, pour one tenth of the master's contents into the first jar, replace its lid and continue to the second, third, fourth jars, until the set is completed. When this first set is done, firmly secure the lids. Replace the lid on the now empty spawn master jar and put it aside. Take each newly inoculated jar, and with a combination of rolling and shaking, distribute the mycelium covered kernels evenly throughout.

5. Incubate at the temperature appropriate for the species being cultivated. In a week the mycelium should totally permeate the grain. Designated G-2, these jars can be used for further inoculations, as spawn for the inoculation of bulk substrates, or as a fruiting medium.

Some species are less aggressive than others. *Agaricus brunnescens* for instance, can take up

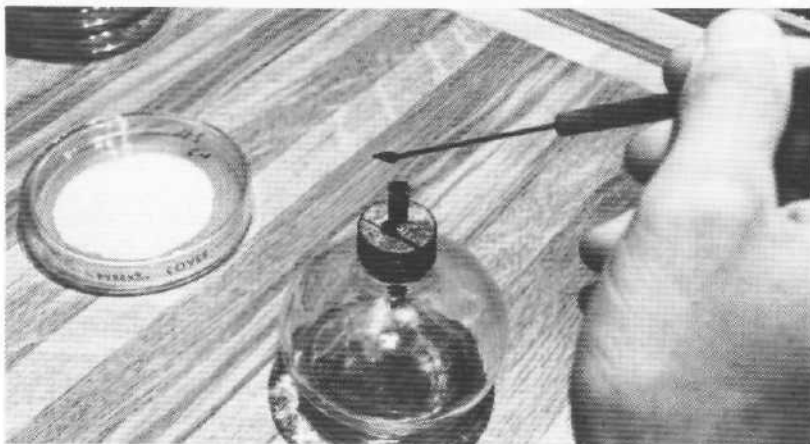

**Figure 49** Flaming the scalpel.

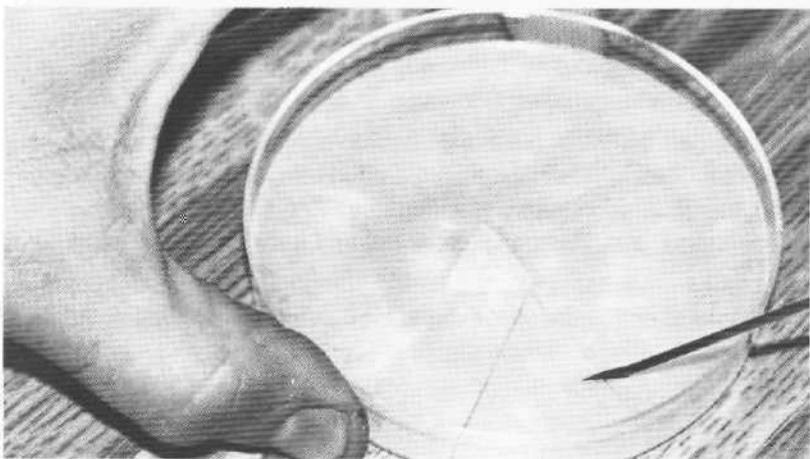

**Figure 50** Cutting two wedges of mycelium colonized agar.



**Figure 51** Inoculating sterilized grain.

and a half weeks to colonize grain while *Psilocybe cubensis* grows through in a week to ten days. Here again, the use of the tire as a striking surface can be an aid to shaking. For slower growing species, a common shaking schedule is on the 5th and 9th days after inoculation. The cultures should be incubated in a semi-sterile environment at the temperature most appropriate for the species being cultivated. (See Chapter XI).

After transferring mycelium from agar to grain, further transfers can be conducted from these grain cultures to even more grain filled jars. A schedule of successive transfers from the first inoculated grain jar, designated G-1, through two more "generations" of transfers (G-2, G-3 respectively) will result in an exponential expansion of mycelial mass. If for instance, 10 jars were inoculated from an agar grown culture (G-1), they could further inoculate 100 jars (G-2) which in turn could go into 1000 jars (G-3). As one can see, it is of critical importance that the first set of spawn masters be absolutely pure for it may ultimately inoculate as many as 1,000 jars! Inoculations beyond the third generation of transfers are not recommended. Indeed, if a contamination rate above 10% is experienced at the second generation of transfers, then consider G-2 a terminal stage. These cultures can inoculate bulk substrates or be laid out in trays, cased and fruited.

Grain-to-grain transfers are one of the most efficient methods of spawn making. This method is preferred by most commercial spawn laboratories specializing in *Agaricus* culture. They in turn sell grain spawn that is a second or third transfer to *Agaricus* farmers who use this to impregnate their compost. For the creation of large quantities of spawn, the grain-to-grain technique is far superior to agar-to-grain for both its ease and speed. However, every cultivator must ultimately return to agar culture in order to maintain the purity of the strain.



**Figure 52a** Spawn master ready for transfer.



**Figure 52b** Spawn master after shaking.



**Figure 52c** Inoculating sterilized grain from spawn master.

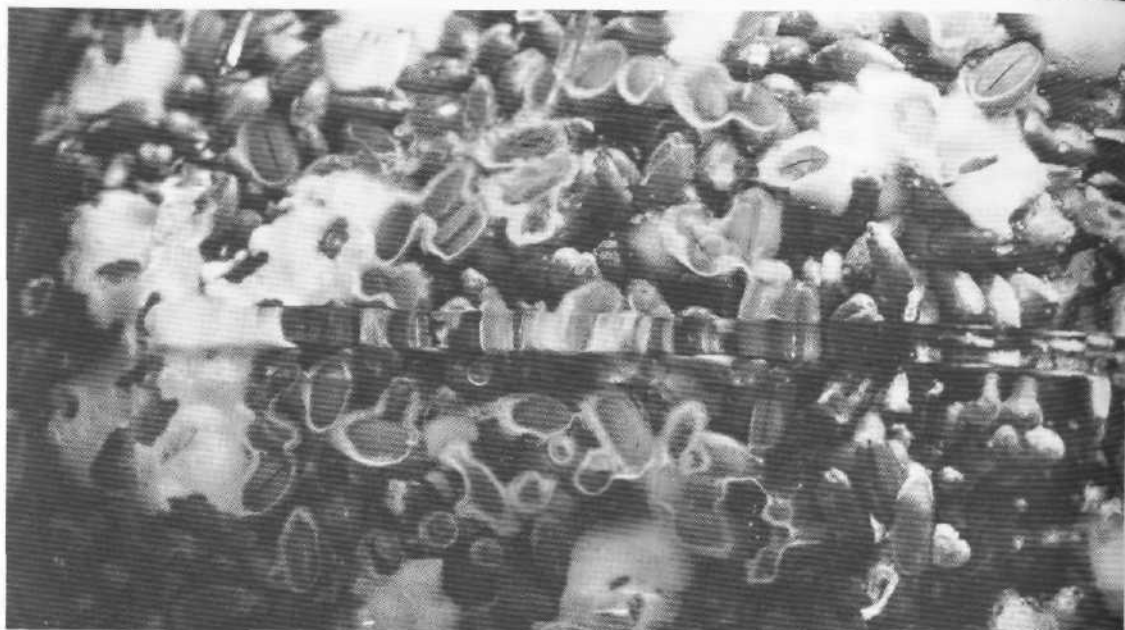

Figure 53 Spawn jar contaminated with Wet Spot bacteria, giving the grain a greasy appearance and emitting a sour odor.

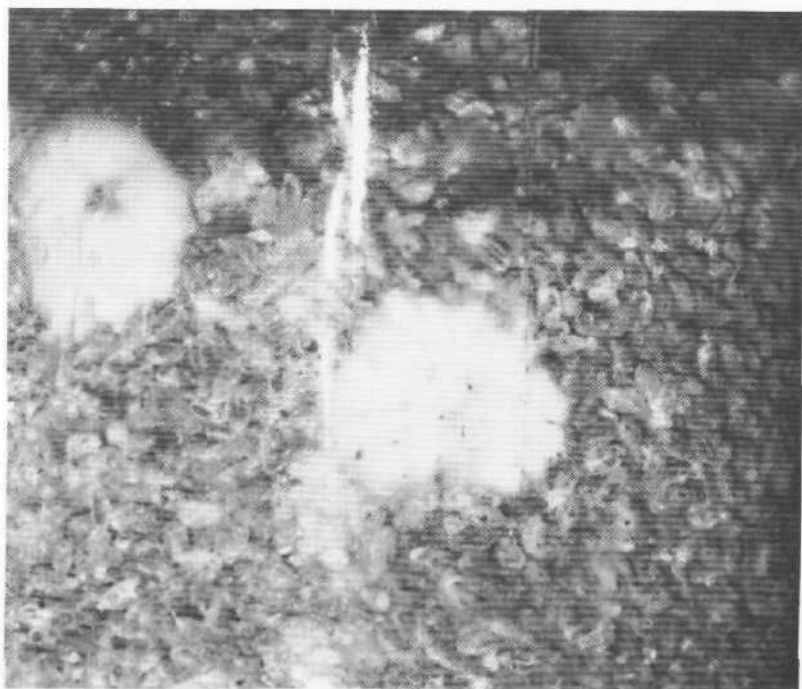

Figure 54 Spawn jar with Heavy Growth, an undesirable characteristic arising from cottony sectors.

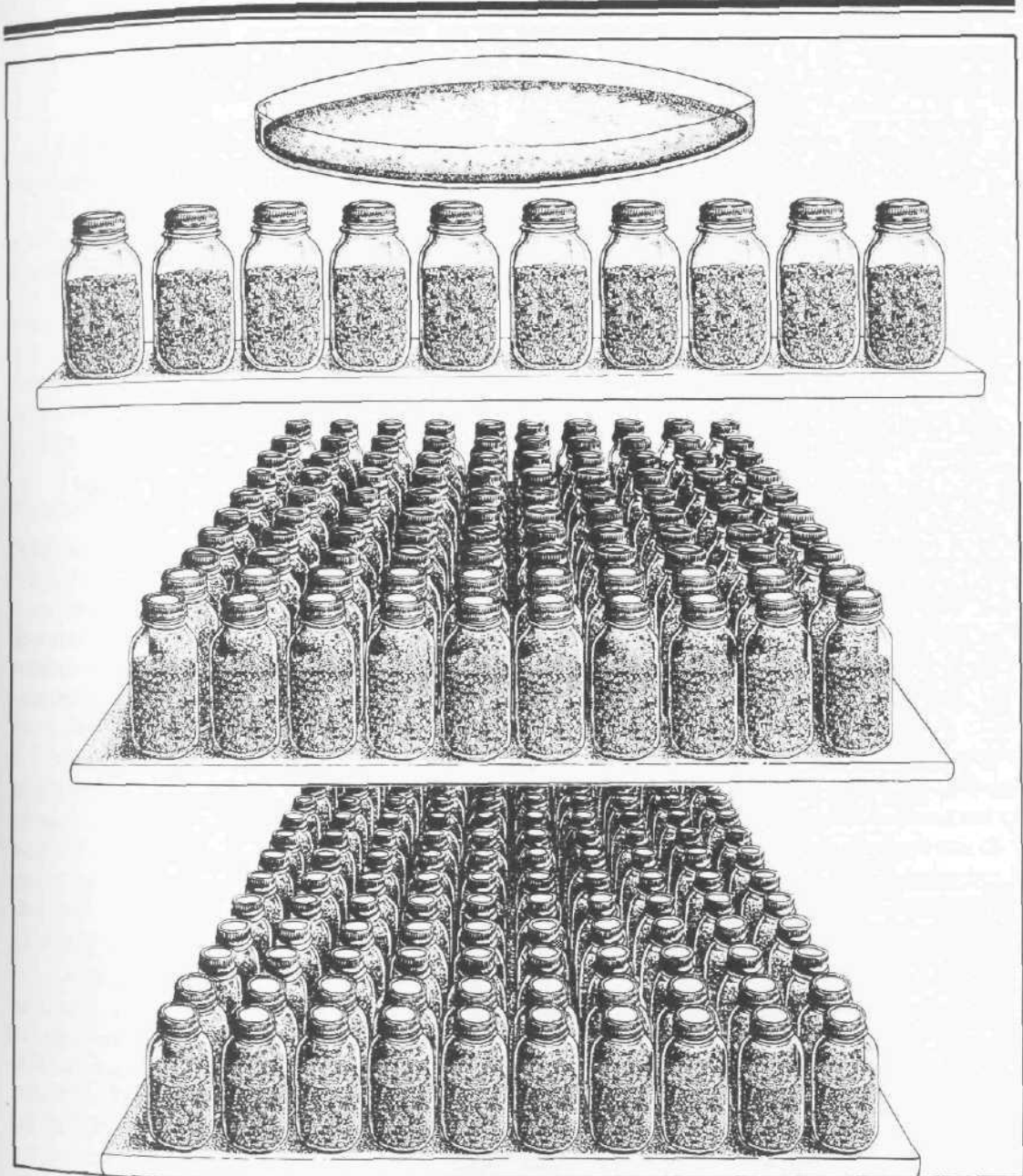

Figure 55 Diagrammatic expansion of mycelial mass using grain-to-grain transfer technique. One petri dish can inoculate 10 spawn jars (G-1) which in turn can be used to inoculate 100 more jars (G-2) and eventually 1000 jars of spawn (G-3) provided the culture remains pure.

## ALTERNATIVE SPAWN MEDIA

Some mushroom species do not grow well on grain and are better suited to alternative spawn media. Other mushrooms are grown on substrates incompatible with grain spawn. For example, sawdust and bran are the preferred spawn materials for the cultivations of wood inhabitants such as *Lentinus edodes* and *Flammulina velutipes*. Another spawn media has a perlite bran base. Perlite is vitreous rock, heated to 1000°F. and exploded like popcorn. The thin flakes of bran are readily sterilized while the perlite gives the medium its structure. The recipes are:

### Sawdust/Bran Spawn

- 4 parts sawdust (hardwood)
- 1 part bran (rice or wheat)

Soak the sawdust in water for a least twenty four hours, allow to drain and then thoroughly mix in the bran. If the mixture has the proper moisture content, a firm squeeze results in a few drops between the fingers. Fill the material firmly to the neck of the spawn container (wide mouth). Japanese spawn makers bore a ½ inch diameter hole down the center of the media into which they later insert their inoculum. Sterilize for 60-90 minutes at 15 psi. Once cooled, inoculate from agar media, liquid emulsion, or grain. A fully grown bottle of sawdust bran spawn can also be used for further inoculations.

### Perlite Spawn

- 120 milliliters water
- 40 grams perlite
- 50 grams wheat bran
- 6 grams gypsum (calcium sulfate)
- 1.5 grams calcium carbonate

Screen the perlite To remove the fine powder and particulates. Fill the container (small mouth) with the dry ingredients and mix well. Add the water and continue mixing until the ingredients are thoroughly moistened. Sterilize for one hour at 15 psi. Inoculate from agar media or liquid emulsion.



Figure 56 Mycelium running through sawdust/bran spawn.

## LIQUID INOCULATION TECHNIQUES

A highly effective technique for inoculating grain utilizes the suspension of fragmented mushroom mycelia in sterile water. This mycelium enriched solution, containing hundreds of minute cellular chains, is then injected into a jar of sterilized grain. As this water seeps down through the agar in mycelial fragments are evenly distributed, each one of which becomes a point of inoculation. For several days little or no sign of growth may be apparent. On the fourth to fifth day after injection, given optimum incubation temperatures, sites of actively growing mycelium become visible. In a matter of hours, these zones enlarge and the grain soon becomes engulfed with mycelium. Using the liquid inoculation Technique eliminates the need for repeated shaking, and a single plate of mycelium can inoculate up to 100 jars, more than ten times the number inoculated by the traditional transfer method. There are several ways to suspend mycelium in water, two of which are described here.

The first method is quite simple. Using an autoclaved glass syringe, inject 30-50 ml. of sterilized water into a healthy culture. Then scrape the surface of the mycelial mat, drawing up as many fragments of mycelium as possible. As little as 5 ml. of mycelial suspension adequately inoculates a quart jar of grain.

The second method incorporates a blender with an autoclavable container-stirrer assembly. (Several companies sell aluminum and stainless steel units specifically manufactured for liquid culture techniques—refer to the sources listed in the Appendix). Fill with water until two thirds to three quarters full, cover with aluminum foil (if a Tight fitting metal top is not handy), sterilize and allow to cool to room temperature.

Under aseptic conditions, insert an entire agar culture of vigorously grown mycelium into the sterilized stirrer by cutting it into four quadrants or into narrow strips. Because many contaminants appear along the outer periphery of a culture dish, it is recommended that these regions not be used. Place all four quadrants or mycelial strips into the liquid. Turn on the blender at high speed for no longer than 5 seconds. (Longer stirring times result not in the fragmentation of cell chains but in The fracturing of individual cells. Such suspensions are inviable). Draw up 5-10 ml. of the mycelium concentrate and inoculate an awaiting grain jar.

A further improvement on this technique calls for a 10:1 dilution of the concentrated mycelial solution. Inject 50 ml. of mycelial suspension into four vessels containing 450 ml. of sterilized water. Narrow mouth quart mason jars are well suited to this technique. Gently shaking each jar will help evenly distribute the mycelium. Next inoculate the grain jars with 10-15 milliliters of the diluted solution. This method results in an exponential increase of liquid inoculum with the water acting as a vehicle for carrying the mycelial fragments deep into the grain filled jar. This is only one technique using water suspended fragments of mycelium. Undoubtedly, there will be further improvements as mycophiles experiment and develop their own techniques.

When using metal lids a small 1-2 mm. hole can be drilled and then covered with tape. When the sterilized containers are to be inoculated, remove the tape, insert the needle of syringe, inject the suspension of mycelia and replace the tape. In this way. the aperture through which the inoculation



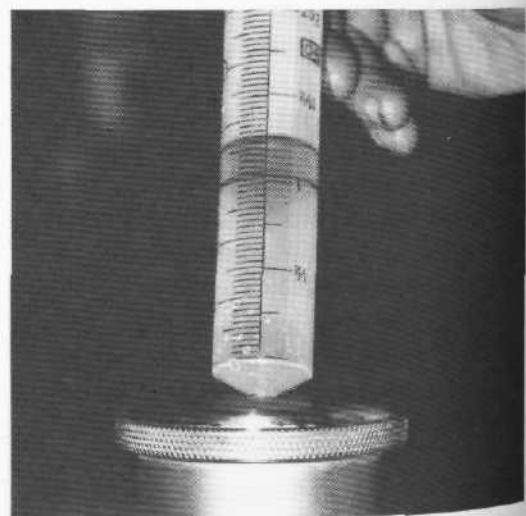

**Figure 57** Drawing up mycelium from culture dish with syringe.

**Figure 58** Syringe inoculation of sterilized grain.

**Figure 59** Eberbach container manufactured for liquid culture. Note bolt covering inoculation hole.

**Figure 60** Drawing up liquid inoculum.

takes place is of minimal size and is exposed for a only second or two. The chance of airborne contamination is minimized.

The liquid inoculation technique works well provided the cultures selected are free from foreign spores; otherwise the entire set of jars inoculated from that dish will be lost. The disadvantage with this method is that there is no opportunity to avoid suspect zones on the culture dish—the water suspends contaminant spores and mycelia alike. If a culture dish is contaminated in one region, a few jars may be lost via the traditional inoculation method while with the liquid inoculation technique whole sets of up to one hundred spawn jars would be made useless.

Although mycelial suspensions created in this manner work for many species, the mycelia of some mushrooms do not survive the stirring process.

## INCUBATION OF SPAWN

With each step in the cultivation process, the mycelial mass and its host substrate increases. In seven days to two weeks after inoculation, the spawn jars should be fully colonized with mushroom mycelia. The danger here is that, if contamination goes undetected, that mold or bacterium will likewise be produced in large quantities. Hence, as time goes by the importance of clean masters becomes paramount. By balancing environmental parameters during incubation, especially temperature, the mycelium is favored.

Once the jars have been inoculated, store them on shelves in a semisterile room whose temperature can be easily controlled. Light and humidity are not important at this time as a sealed jar should retain its moisture. Air circulation is important only if the incubating jars overheat. In packing a room tightly with spawn jars, overheating is a danger. Many thermophilic fungi that are inactive at room temperature flourish at temperatures too high for mushrooms. Herein lies one of the major problems with rooms having a high density of incubating spawn jars. If possible, some provisions should be made to prevent temperature stratification in the incubation environment.

The major factor influencing the rate of mycelial growth is temperature. For every species there is an optimum temperature at which the rate of mycelial growth is maximized. As a general rule, the best temperature for vegetative (spawn) growth is several degrees higher than the one most stimulatory for fruiting. In Chapter XI, these optimum temperatures and other parameters are listed for more than a dozen cultivated mushrooms. Yet another factor affecting both growth rate and susceptibility to contamination is moisture content, a subject covered in the previous chapter on grain culture.

Every day or so inspect the jars and check for the slightest sign of contamination. The most common are the green molds *Penicillium* and *Aspergillus*. If contamination is detected, sea the lid and remove the infected culture from the laboratory and growing facility. If a jar is suspected to be contaminated, mark it for future inspection.

Not all discolorations of the grain are *de facto* contaminants. Mushroom mycelium exudes a yellowish liquid metabolite that collects as droplets around the myceliated kernels of grain. As the culture ages and the kernels are digested, more metabolic wastes are secreted. Although this secre-



**Figure 61** Half gallon jars of spawn incubating in semisterile environment.

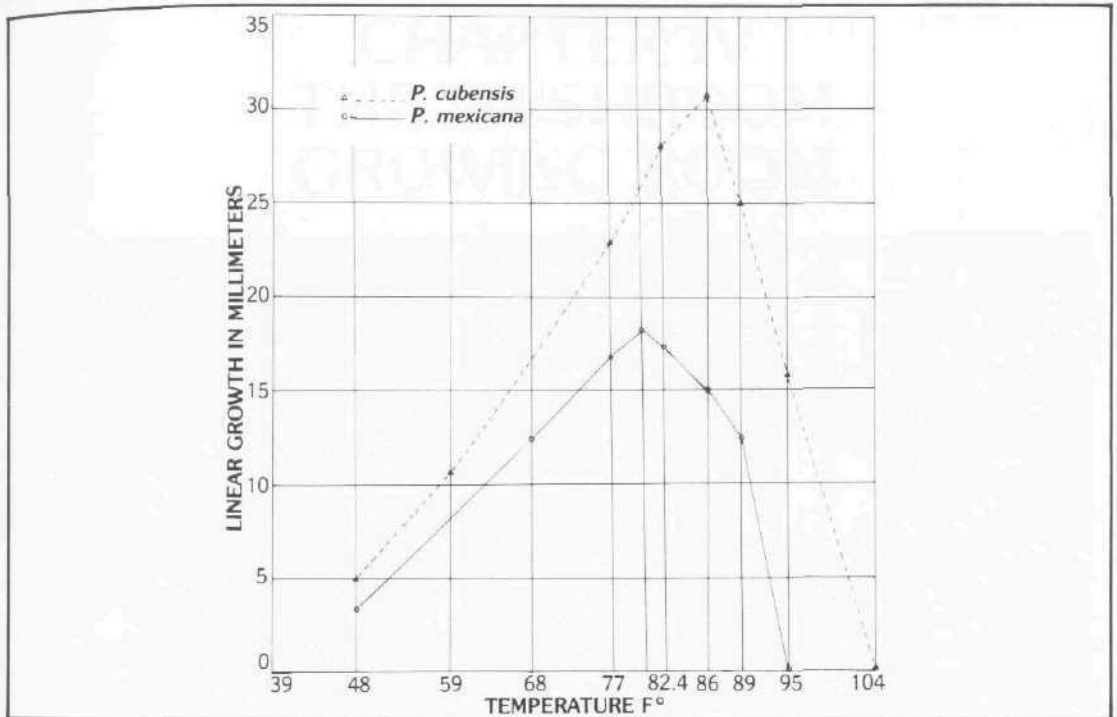

**Figure 62** Gallon jars incubating in semi-sterile environment.

tion is mostly composed of alcohols (ethanol and acetone), in time acids are produced that cause the lowering of The substrate's pH. These waste products are favorable to the propagation of bacteria that thrive in aqueous environments. Small amounts of this fluid do not endanger the culture; excessive waste fluids (where the culture takes on a yellowish hue) are definitely detrimental. If this fluid collects in quantities, the mycelium sickens and eventually dies in its own wastes. Such excessive "sweating" is indicative of one or a combination of the following conditions:

1. Incubation at too high a temperature for the species being cultivated. Note that the temperature within a spawn jar is several degrees higher than the surrounding air temperature.
2. Over-aging of the cultures; too lengthy an incubation period.
3. Lack of gas exchange, encouraging anaerobic contamination.

Contaminated jars should be sterilized on a weekly basis. Do not dig out moldy cultures unless they have been autoclaved or if the identity of the contaminant in question is known to be benign. Several contaminants in mushroom culture are pathogenic to humans, causing a variety of skin diseases and respiratory ailments. (See Chapter XIII on the contaminants of mushroom culture). Autoclave contaminated jars for 30 minutes at 15 psi and clean soon after. Many autoclaved jars, once contaminated, re-contaminate within only a few days if their contents have been not discarded.



**Figure 63** Chart showing influence of temperature on the rate of mycelial growth in *Psilocybe cubensis* and *Psilocybe mexicana*. (Adapted from Ames et al., 1958).

If an exceptionally high contamination rate persists, review the possible sources of contamination, particularly the quality of the master spawn cultures (such as the moisture content of the grain) and the general hygiene of the immediate environment. Once the cultures have grown through with mycelium and are of known purity, this spawn can be used to inoculate bulk substrates or can be laid out in trays, cased and fruited.

## CHAPTER IV THE MUSHROOM GROWING ROOM

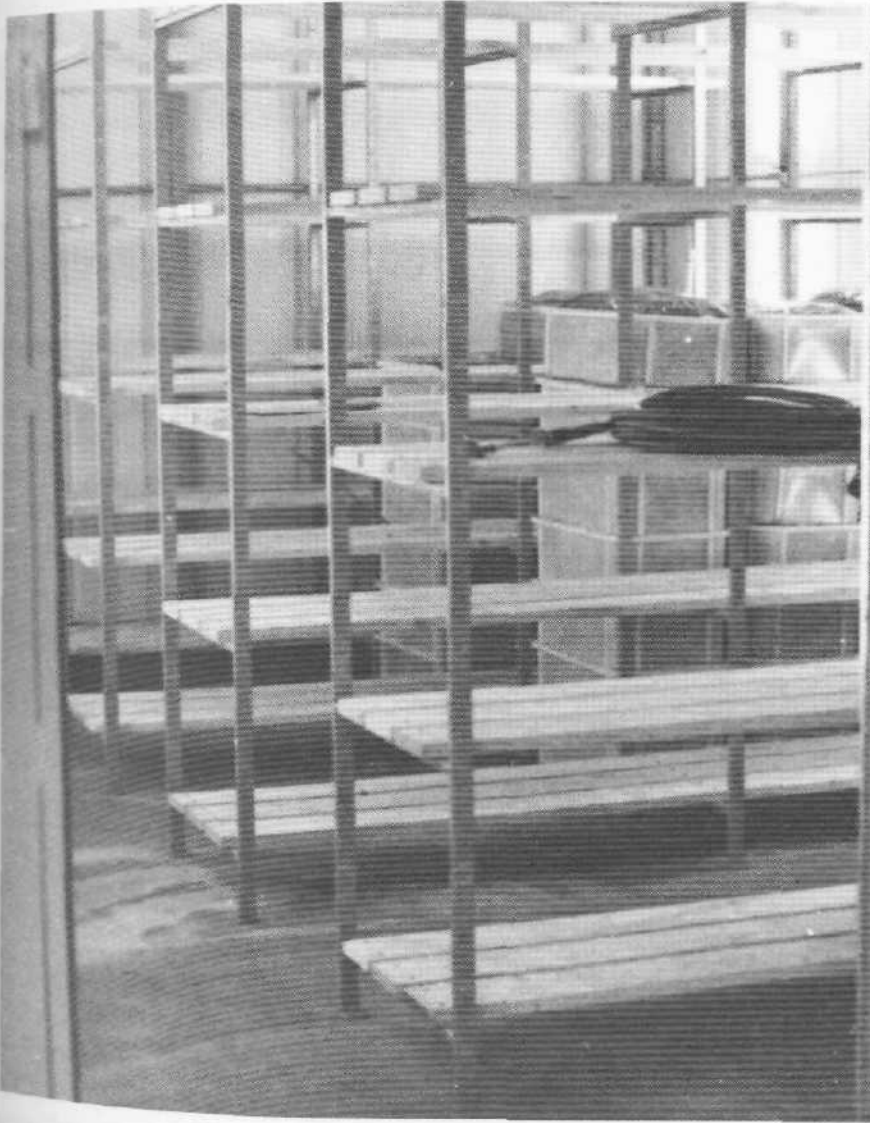

Figure 64 Small growing room utilizing shelves.

## STRUCTURE AND GROWING SYSTEMS

Mushroom cultivation was originally an outdoor activity dependent on seasonal conditions. Substrates were prepared and spawned when outside temperatures and humidity were favorable. This is still the case with many small scale growers of *Volvariella volvacea*, *Stropharia rugoso-annulata* and *Lentinus edodes*.

*Agaricus* cultivators grow solely indoors. Initially, *Agaricus* growers in France adapted the limestone mines near Paris and in the Loire valley to meet the necessary cultural requirements of that mushroom. These "caves" were well suited because of their constant temperature and high humidity, essential requirements for mushroom growing. When the first houses designed solely for mushrooms were built in the early 1900's, temperature and humidity control were the main factors guiding their construction.

For the home cultivator, a growing room should be scaled according to the scope of the project. The following guidelines supply the information to properly design and equip a growing chamber, basement growing room, outdoor shed or garage.

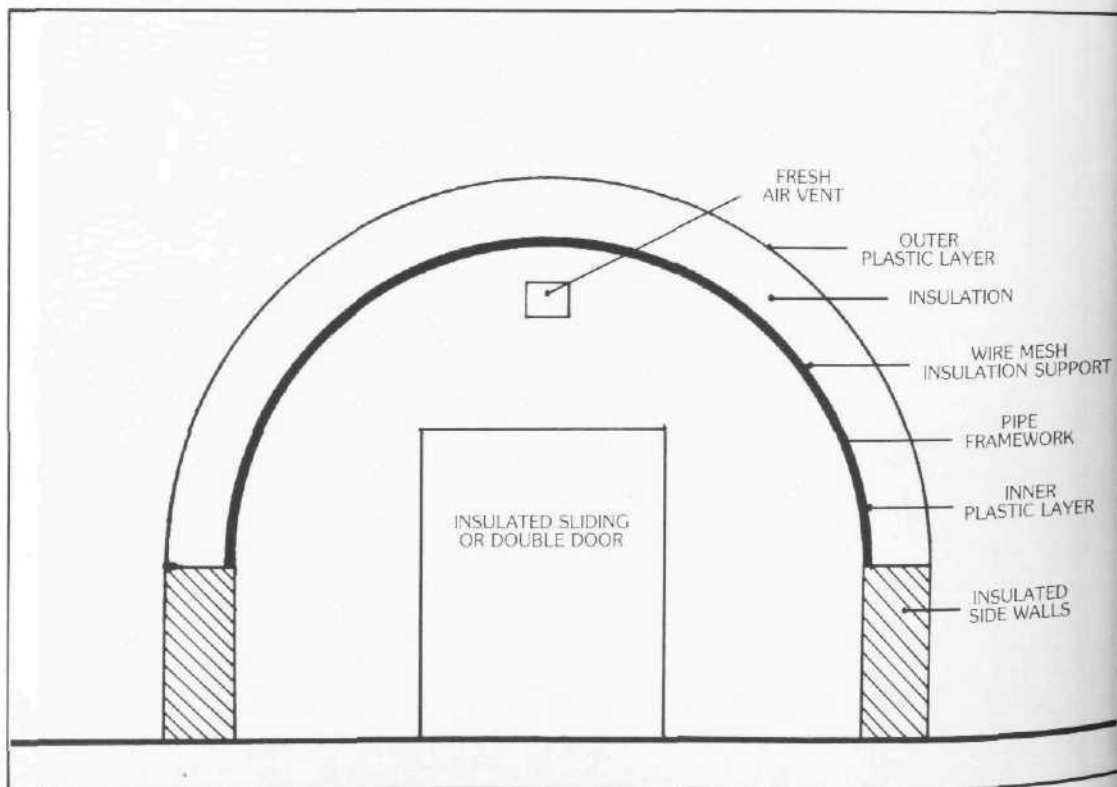

Figure 65 An insulated plastic greenhouse suitable for mushroom growing.

## Structure

The basic structure of a mushroom house is made of wood or concrete block with a cement floor. Because water collects on the floor during the cropping cycle, provisions should be made for drainage. A wood floor can be covered with a heavy guage plastic. Interior walls, ceilings and exposed wood surfaces should be treated with a marine enamel or epoxy-plastic based paint. A white color enhances lighting and exposes any contaminating molds.

The most important feature of a growing room is the ability to maintain a constant temperature. In this respect, insulation is critical. The walls should be insulated with  $R = 11$  or  $R = 19$  and the ceiling with  $R = 30$  insulating materials. Fiberglass or styrofoam work well but should be protected from the high humidities of the growing room to prevent water from saturating them. For This purpose, a 2-4 mil. plastic vapor barrier is placed between The insulation and the interior wall.

An airtight room is an essential feature of the mushroom growing environment, preventing insects and spores from entering as well as giving the cultivator full control over the fresh air supply. During The construction or modification of the room, all cracks, seams and joints should be carefully sealed.

Many growers modify existing rooms in their own homes or basements. The main consideration for this approach is to protect the house structure (normally wood) from water damage and to make the growing chamber airtight. This is accomplished by plastic sheets stapled or taped to the walls, ceiling and floor, with the seams and adjoining pieces well sealed. If the room is adjacent to an exterior house wall where a wide temperature fluctuation occurs, condensation may form between the plastic and The wall. Within these larger structures, a plastic Tent or envelope room can be con-

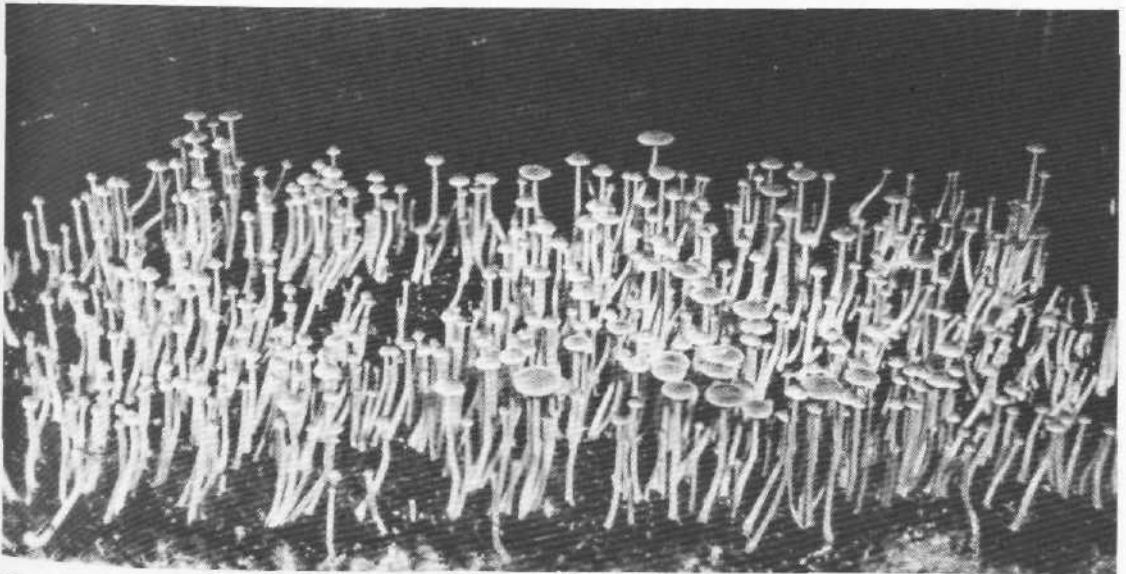

Figure 66 Cultivation of mushrooms in an aquarium.

structed. Such a structure can be framed with 2" PVC pipe. The pipe forms a box frame to which the plastic is attached. This type of growing room should not need insulation because of the air buffer between it and the larger room.

Porches, basements and garages can all be modified in the ways just mentioned. These areas can also be used with little additional change if the climate of the region is compatible with the mushroom species being grown. For example, *Lentinus edodes*, the shiitake mushroom, readily fruits at 50-60 degrees F. in a garage or basement environment.

The newest innovation in mushroom growing structures is the insulated plastic greenhouse. The framework is made of galvanized metal pipe bent into a semi-circular shape and mounted at ground level or on a 3.5 foot side wall. The ends of the walls and the doors are framed with wood. Heavy plastic (5-6 mil) is stretched over the metal framework to form the inner skin of the room. A layer of wire mesh is laid over the plastic and functions to hold 3-6 inches of fiberglass insulation in place. A second plastic sheet covers the insulation and protects it from the weather. The plastic should be stretched tight and anchored well. These layers are held in place by structural cable spanning the top and secured at each side. (See Figure 65). This type of structure, plastic coverings and plastic fasteners are all available at nursery supply companies. Remember, the design of a mushroom growing room strives to minimize heat gain and loss.

For people with little or no available space, "mini-culture" in small environmental chambers may be the most appropriate way to grow mushrooms. Styrofoam ice chests, aquariums and plastic lined wood or cardboard boxes can all be used successfully. Because of the small volume of substrates contained in one of these chambers, air exchange requirements are minimal. Usually, enough air is exchanged in opening the chamber for a daily or twice daily misting. Clear, perforated plastic covering the opening maintains the necessary humidity and the heat can be supplied by the outer room. Larger chambers can be equipped with heating coils or a light bulb on a rheostat. Both should be mounted at the base of the chamber. Mini-culture is an excellent and proven way to grow small quantities of mushrooms for those not having the time or resources to erect larger, more controlled environments.

## Shelves

The most common indoor cultivation method is the shelf system. In this system, shelves form a platform upon which the mushroom growing substrate is placed. The shelf framework consists of upright posts with cross bars at each level to support the shelf boards. This fixed framework is constructed of wood or non-corrosive tubular metal. The shelves should be a preservative-treated softwood. The bottom boards are commonly six inches wide with one inch spaces between them. Side boards are 6-8 inches high depending on the depth of fill. A standardized design is shown in Figure 67. All shelf boards are placed unattached thereby allowing easy filling, emptying and cleaning. *Agaricus* growers fill the shelf house from the bottom up. The shelf boards are stacked at the side of the room and put into place after each level is completed.

The center pole design (shown in Figure 67) is a simple variation that is less restrictive and ideally suited for growing in plastic bags. Another alternative is to use metal storage shelves. These

---



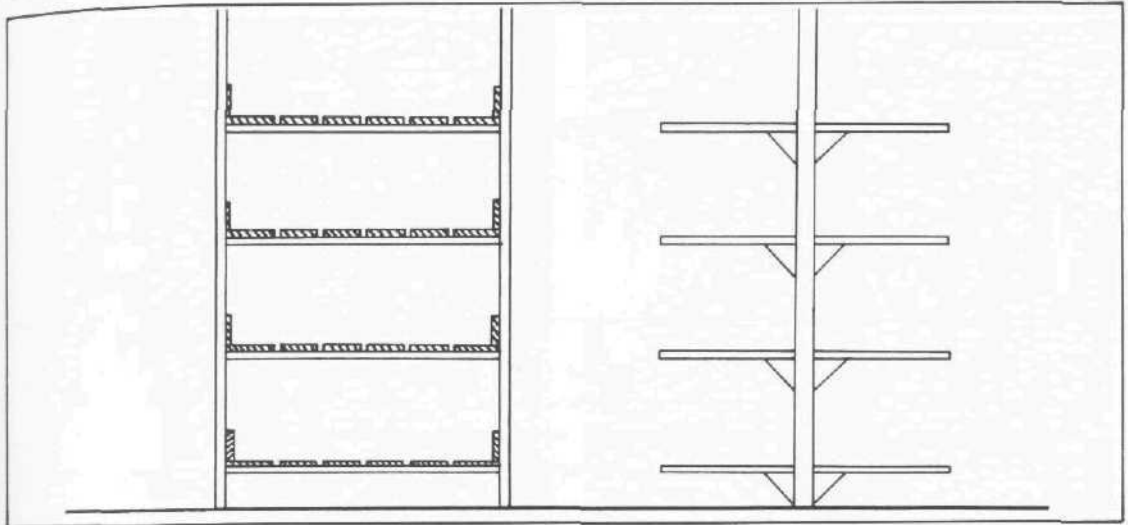

**Figure 67** Double support and centerpole design shelves. Both shelves are firmly attached to the floor and the ceiling.

units come in a variety of widths and lengths and have the distinct advantage of being impervious to disease growth. Their use is particularly appropriate for cropping on sterilized substrates in small containers.

## Trays

The development of the tray system in *Agaricus* culture is largely due to the work of Dr. James Sinden. In direct contrast to anchored static shelves, trays are individual cropping units that have the distinct advantage of being mobile. This mobility has made mechanization of commercial cultivation possible. Automated tray lines are capable of filling, spawning and casing in less time, with fewer people and with better quality management.

Whereas in the shelf system all stages of the cultural cycle occur in the same room, The tray system utilizes a separate room for Phase II composting. On a commercial tray farm only the Phase II room is equipped for steaming and high velocity air movement.

A Sinden system tray design is shown in Figure 68. This tray has short legs in the up-position. During Phase II and spawn running these trays are stacked 15 cm. apart and tightly placed within the room to fully utilize compost heat. After casing, a wooden spacer is inserted between the trays for crop management, increasing the space to 25-35 cm. Other tray designs have longer legs in the down position and higher sideboards to accommodate more compost. These trays are similarly spaced throughout the cycle. In the growing room, trays can be stacked 3-6 high in evenly spaced rows. The main considerations for the home cultivator are that the trays can be easily handled and at they fit the floor space of the room.

The real advantage of the tray system is the ability to fill, spawn and case single units in an unre-

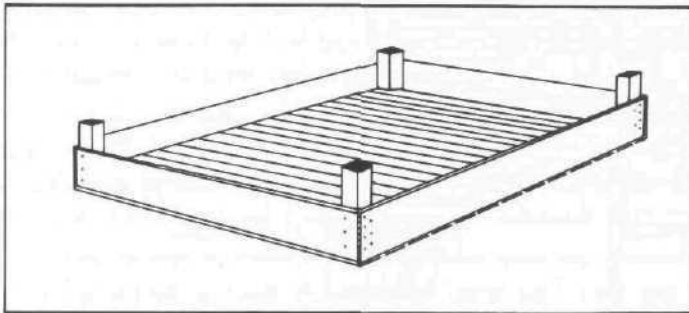

**Figure 68 Sinden system tray.** The tray can be constructed of 1 x 6 or 2 x 6 inch lumber for bottom and side boards and 4 x 4 inch corner posts. (1 x 8 or 2 x 8 inch side boards are suggested for deep fills).

stricted environment outside the actual growing room. The tray system also gives the cultivator more control over hygiene and improves the efficiency of the operation. Moving trays from room to room does present contamination possibilities; therefore, the operations room must also be clean and fly tight for spawning and casing. Because there is no fixed framework in the growing room, it is easily cleaned and disinfected.

The tray method has many distinct advantages over the mason jar method for home cultivators preferring to fruit mushrooms on sterilized grain. These advantages are: fewer necessary spawn containers; fewer aborts due to uncontrolled primordia formation between the glass/grain interface; ease of picking and watering; better ratio of surface area to grain depth; and comparatively higher yields on the first and second flushes. An inexpensive tray is the 3-4 inch deep plant propagation flat commonly sold for starting seedlings. An example of such a tray is pictured in Fig. 69.

## THE ENVIRONMENTAL CONTROL SYSTEM

The mushroom growing room is designed to maintain a selected temperature range at high relative humidities. This is accomplished Through adequate insulation and an environmental control system with provisions for heating, cooling, humidification and air handling.

In the original shelf houses the environment was controlled by a combination of active and passive means. Fresh air was introduced through adjustable vents running the length of the ceiling above the center aisle. Heat was supplied by a hot water pipe along The side walls, a foot above ground level. And humidity was controlled by similarly placed piping carrying live steam. The warm air rising up the walls in combination with the cool fresh air falling down the center aisle created convection currents for air circulation. Although no longer in general use by *Agaricus* growers, air movement based on convection can be similarly designed for small growth chambers where mechanical means are inappropriate.

Present day *Agaricus* farms integrate heating, cooling and humidification equipment into the air handling system and in this way are able to achieve balanced conditions throughout the growing room. Figure 73 shows an example of this type of system.

### Fresh Air

Filtered fresh air enters the room at the mixing box where it is proportionally regulated with re-

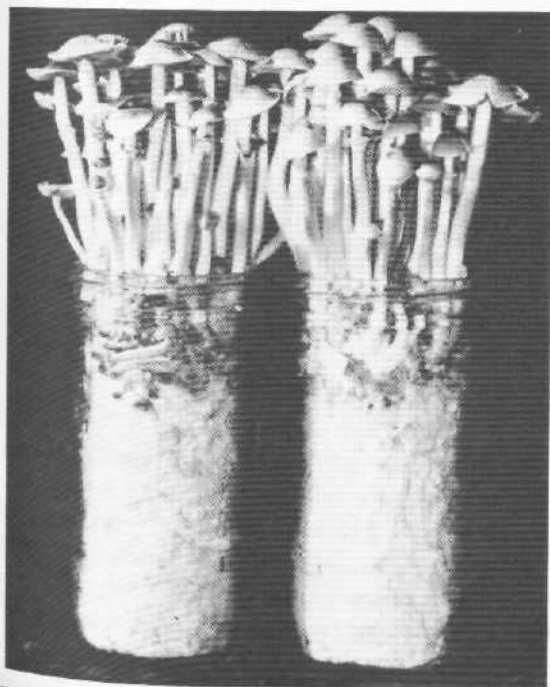
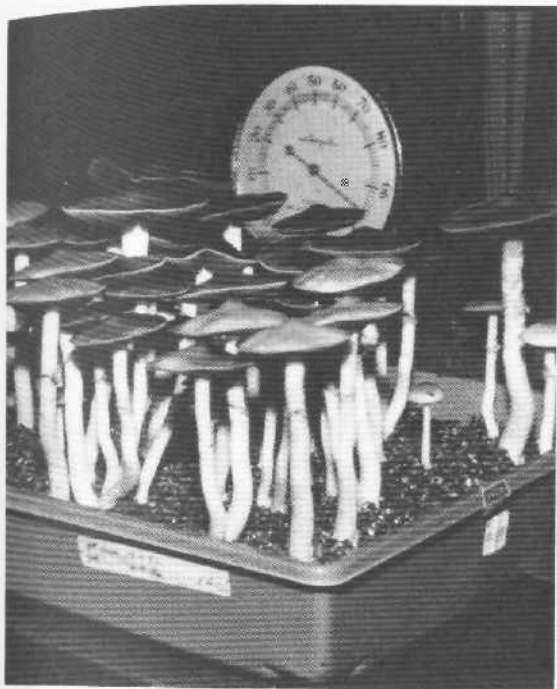
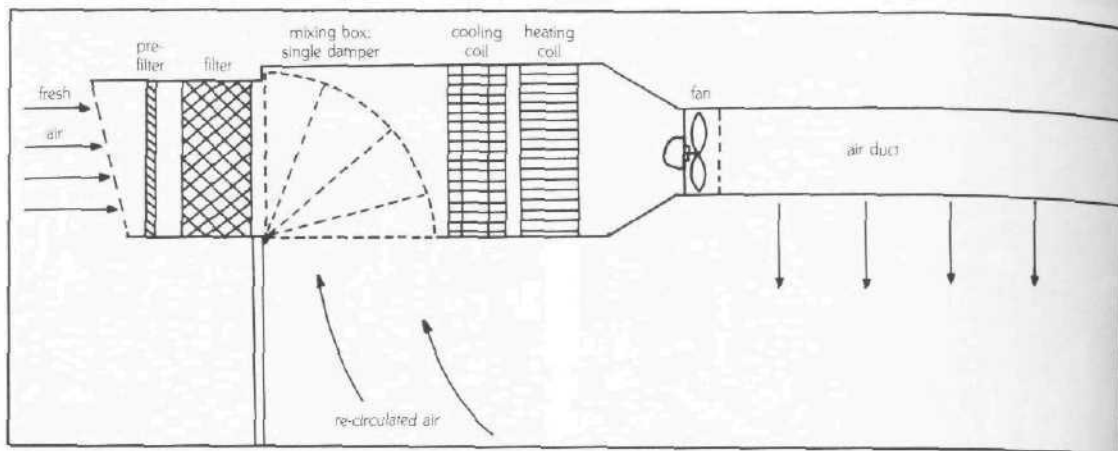

Figure 69 *Psilocybe cubensis* fruiting on cased grain in a tray.

Figure 70 *Psilocybe cubensis* fruiting in pint and a half jars.

Figure 71 *Psilocybe cubensis* fruiting in pint jars.

Figure 72 *Psilocybe cubensis* fruiting in a plastic lined box.



**Figure 73** Standard ventilation system used by *Agaricus* growers. (After Vedder)

circulated air by a single damper. To prevent leakage during spawn running and pre-pinning, the damper fits tightly against the fresh air inlet. This allows full recirculation of room air to maintain even conditions, thereby counteracting temperature and  $\text{CO}_2$  stratification. When fresh air is required, the damper can be adjusted to any setting, including complete closure of the recirculation inlet. As fresh air is introduced, room air is displaced and evacuated through an exhaust vent or cracks around the door. Because fresh air is generally at a different temperature than the one required for the growing room, it must be used judiciously in order to avoid disrupting the growing room environment or overworking the heating, cooling and humidification systems. By properly mixing the fresh outside air and the room air, a balance can be achieved and optimum conditions for mushroom growth prevail.

Fresh air serves many important functions in mushroom culture, primarily by supplying oxygen to the growing mushrooms and carrying away  $\text{CO}_2$ . Fresh air also facilitates moisture evaporation from the cropping surface. To determine the exact amount of air needed in a given situation, a knowledge of the  $\text{CO}_2$  requirements for the species being grown is necessary. (See Chapter XI on growing parameters for various species). The fresh air can also be measured in terms of air changes per hour, a common way mushroom growers size the fan in the growing room.

## Fans

Axial flow and centrifugal fans are the two most commonly used in mushroom houses. Both fans operate well against high static pressure, which is a measure of the resistance to forced air. Static pressure is measured in inches of water gauge—the height in inches to which the pressure lifts a column of water—and is caused by filters, heating and cooling coils or other obstructions to the free flow of air. Fans are rated in terms of their output, a measurement of cubic feet per minute (CFM) at varying static pressures (S.P.). When choosing a fan, these two factors must be considered for proper sizing.

*Agaricus* growers use fans capable of 4-6 changes per hour, or 0.5 CFM per square foot of cropping surface. For most small growing rooms, an axial flow fan, 6-10 inches in diameter and delivering between 100-500 CFM at up to 0.5 inches of static pressure, should meet general growing requirements. The addition of a variable speed motor control allows precise air velocity adjustment during different phases of the cultural cycle. This is especially important if the static pressure increases from spore build-up in the filter. A convenient method of testing air circulation is by blowing a small amount of cigarette smoke onto the cropping surface: the smoke should dissipate within twenty seconds.

The minimum fan output for a given room can be determined through knowledge of the air changes per hour required by the mushroom species. First calculate the volume of the room in cubic feet (height x width x length) and subtract from this The volume occupied by trays, shelves, substrate and other fixtures. This figure is the free air space in the room. By dividing the CFM (cubic feet per minute) of the fan into the cubic feet of free air space, the time in minutes it takes for one air change is determined. This number is then divided into 60 minutes to calculate the air changes per hour. Another method to determine the CFM of the fan needed is described below.

Let X = the desired net CFM of a high pressure fan pushing through a filter.

Let Y = the total cubic feet of FREE air space in the growing room.

A maximum number of air exchanges/hour for *Agaricus brunnescens* is 4-6.

A maximum number of air exchanges/hour for *Psilocybe cubensis* is 2-3.

Therefore:

$$4 \text{ air exchanges/hour} * Y = 60 \text{ minutes} * X$$

$$\frac{4 * Y}{60 \text{ minutes}} = X = \text{necessary net CFM of fan}$$

$$\frac{Y}{15} = X$$

Example: If the growing environment measures 8 ft. x 8 ft. x 15 ft., the total volume would be 960 cu. ft. If the beds occupy 160 cu. ft. the net volume of free air space would be Y = 800 cu. ft. Therefore:

$$\frac{4 * 800 \text{ cu. ft.}}{60 \text{ min.}} = X$$

$$\frac{3200 \text{ cubic feet}}{60 \text{ min.}} = X$$

$$53.3 \text{ CFM} = X$$

Another factor of importance for proper ventilation is the air-to-bed ratio, which is the cubic feet of free air space divided by square feet of cropping surface. *Agaricus* growers have found a ratio of 5:1 to be optimum and this serves as a useful guideline when cropping other mushrooms on bulk

substrates. The reason this ratio is so important is that increased amounts of substrate can generate heat and carbon dioxide beyond the handling capacity of the ventilation system. A large free air space acts to buffer these changes. Ostensibly, a ventilation system could be matched with a room having a 3:1 air-to-bed ratio, but it would have to move such a volume of air that evaporation off the sensitive cropping surface would be uncontrollable and excessive. Growing mushrooms on thin layers of grain (1 -3 inches), however, produces less CO<sub>2</sub> than growing on 8 inches of compost and consequently would emit a lower air-to-bed ratio.

## Air Ducting

Ducting for the air system is standard inflatable polyethylene tubing, sized to conform to the fan diameter. If ducting is not available in the correct size, PVC pipe can be substituted. Figures 74, 75 and 76 show different air distribution arrangements and their flow patterns. The ducts run the length of the room at ceiling level. One is centrally mounted and discharges towards both walls or directly down the center aisle, whereas the other is wall mounted and is directed across the width of the room.

The outlet holes in the duct are designed to discharge air at such a velocity that the airstream reaches the walls and passes down to the floor without directly hitting the top containers. The holes are spaced so that the boundaries of the adjacent jets meet just before reaching the wall or floor. This effectively eliminates dead-air pockets. To size and space the outlet holes exactly, two guidelines are used:

1. The total surface area of the holes is equal to the cross section of the duct. (The area of a circle is 22/7 times the radius squared,  $A = (r)^2$ ).
2. The space between the holes is equal to a quarter of the distance between the duct and the wall or floor.

The discharge of air at velocities sufficient to draw in surrounding room air is called entrainment, a phenomenon that enhances the capacity of the air circulation system. A flow pattern of even air is then reached that directly benefits the growing mushrooms. The entrainment of air is the goal of air management in the growing room.

## Filters

Fresh air filters are an important part of the ventilation system and contribute to the health of the crop. Their function is to screen out atmospheric dust particles like smoke, silica, soot and decayed biological matter. Atmospheric dust also contains spores, bacteria and plant pollen, some of which are detrimental to mushroom culture. Furthermore, spores and microorganisms originating within the cropping room can also be spread by air movement. To counteract this danger, some mushroom farms filter recirculated air as well.

*Agaricus* growers commonly use high efficiency, extended surface, dry filters. These filters are of pleated or deep fold design which gives them much more surface area than their frame opening. They filter out 0.3 micron particles with 90-95% efficiency and 5.0 micron particles with an effi-

Figure 74 Central aisle outward flow air circulation pattern.

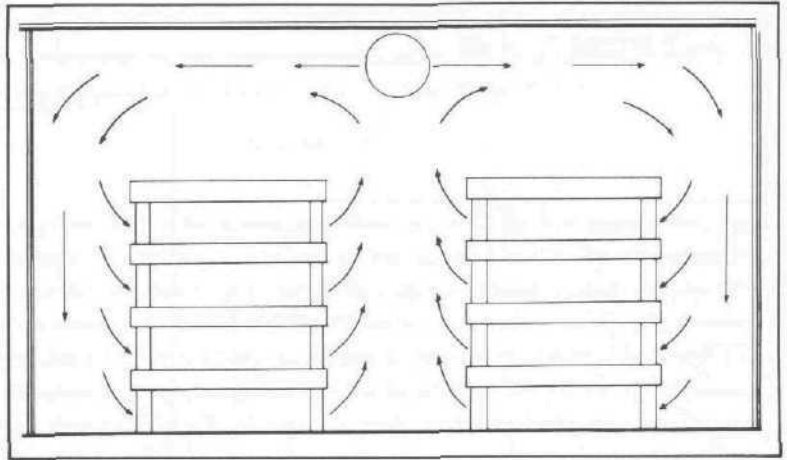

Figure 75 Central aisle downflow air circulation pattern with wall mounted baseboard heating.

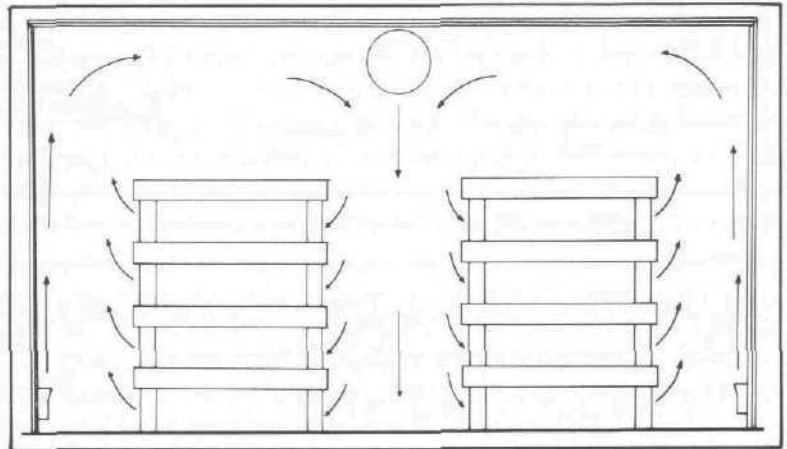
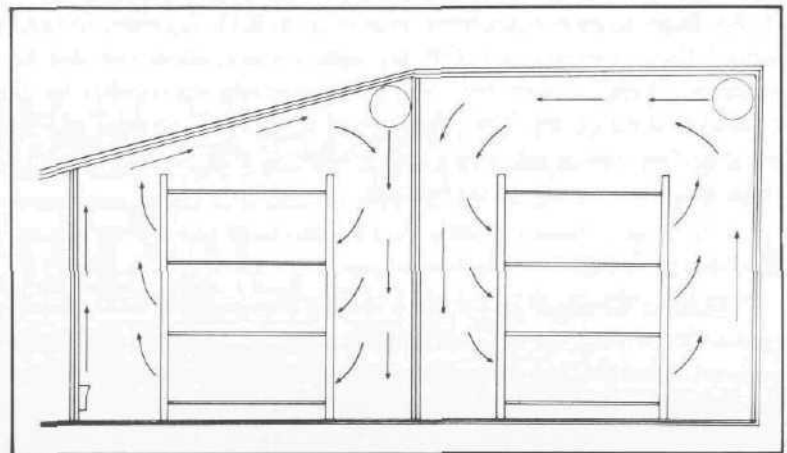
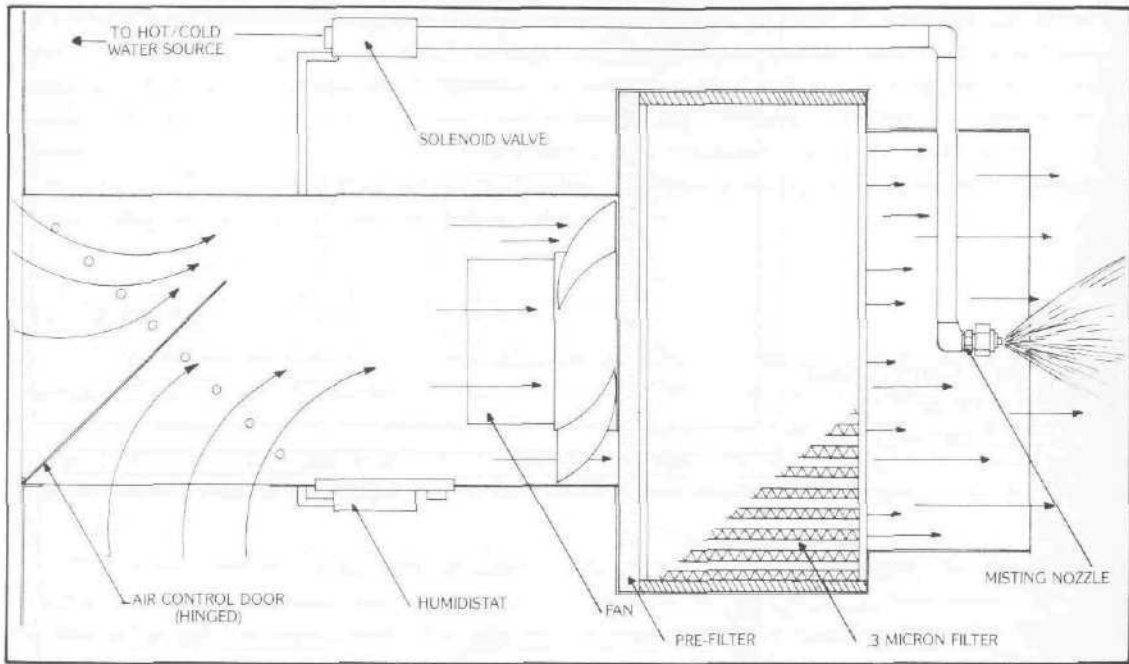

Figure 76 Wall mounted duct directing airflow across the width or down the sidewall of the room.





**Figure 77 Schematic of mixing box and controlled recirculation system in the growing room.**

ciency of 99% at an initial resistance of 0.10 to 0.50 inches of static pressure.

High efficiency Particulate air (HEPA) filters are even more efficient than those just described and are cost effective for the home cultivator. They screen out particulates down to 0.1-0.3 microns with a rated 99.96% to 99.99% efficiency and have a resistance of .75-1.00 inches of static pressure. HEPA filters are made of a variety of materials, depending on their intended application. Most HEPA filters operate in environments of up to 80% humidity without disintegration. Special "waterproof" filters operable in 100% humidity environments can also be purchased at little or no extra expense. These "waterproof" filters are especially appropriate for use with systems that push recirculated air through the filter. This type of system is illustrated in Figure 77. To protect the filters and prolong their usefulness, a one inch prefilter of open celled foam or fiberglass (of the furnace type) is installed to remove large particulates.

## Exhaust Vents

Exhaust vents are designed to relieve overpressure within the growing room caused by the introduction of fresh air. Without an exit for the air, a back pressure is created that increases resistance and reduces the CFM of the fan. Small rooms operating with low fresh air requirements can forgo special exhaust vents and allow the air to escape around the seals of the room entrance, in effect creating a positive pressure environment. Positive pressure within a room can also be created by



undersizing the exhaust vent, which should be no larger than half the size of the fresh air inlet. Free draining dampers operating on overpressure are widely employed in the mushroom growing industry. The outlet should be screened from the inside to prevent the entry of flies.

## Heating

Heating systems for cropping rooms can be based on either dry heat or live steam. Dry heat refers to a heating source that lowers the moisture content of the air as it raises the temperature. These systems utilize either hot water or steam circulating through a closed system of pipes or radiator coils. Heating systems can also be simple resistance coils or baseboard electric heaters. Heat coils are placed in the air circulation system ahead of the fan as shown in Figure 73. Small portable space heaters can also be attached to the mixing box or placed on the wall under it. Otherwise, baseboard heaters can be installed along the length of the side walls and matched with the air circulation design shown in Figure 75.

Heat supplied by live steam has the advantage of keeping the humidity high while raising the temperature of the room. If regulated correctly, steam can maintain the temperature and relative humidity within the required ranges without drawing upon other sources. Nevertheless, a backup heat source is advantageous in the event humidity levels become too high. For steam heat to function properly it should be controlled volumetrically by adjusting a hand valve (rather than simply on and off). Vaporizers well suited for small growing rooms are available in varying capacities, and can be fitted with a duct that connects with the air system downstream from the fan and filter.

To avoid high energy consumption and the expense associated with equipment purchase, operation and maintenance, the growing room should be designed to take full advantage of the heat generating capabilities of the substrate. This is done by matching the air-to-bed ratio to the type of substrate. Growing on thin layers of grain can be done with a ratio of 4:1 (or less) whereas compost demands 5:1. The influence of the outside climate and its capacity for cooling the growing room should also be considered. All these factors must be evaluated before a growing environment with efficient temperature control can be constructed.

## Cooling

Commercial farms use cooling coils with cold water or glycol circulating through them. The coils are placed before the fan as shown in Figure 73 and are supplied by a central chiller or underground tank and well. Other systems use home or industrial refrigeration or air conditioning units that operate with a compressor and liquid coolant filled coils. These units are positioned to draw in recirculated as well as fresh air. All these systems share the common trait of drawing warm air over a colder surface. In doing so, moisture condenses out of the air and in effect dehumidifies the room.

The oldest and most widely practiced method of cooling is through the use of fresh air. Cooling with fresh air depends upon the weather and the temperature requirements of the species being cultivated. However, its use is the most practical means available to the home cultivator. In climates with high daily temperatures, fresh air can be shut off or reduced to a minimum during the day and

then fully opened at night when temperatures are at their lowest.

## Humidification

Most mushroom growers use steam as the principal means of humidification. The steam is injected into the air system duct on the downstream side of the fan and filter. Household vaporizers are well suited for small growing rooms. They are available in various capacities and can be fitted with a duct running to the air system. The vaporizer can also be positioned under the mixing box for steam uptake with the recirculated air. Keep in mind that cold fresh air has much less capacity for moisture absorption and therefore does not mix well with large volumes of steam.

Another method of humidification uses atomizing nozzles to project a fine mist into the air stream. Large systems have a separate mixing chamber with nozzles mounted to spray the passing air. In a small room, a single nozzle can be mounted in the center of the duct and aimed to flow with the air as it exits the fan. (See Figure 77). An appropriately sized nozzle emits 0.5-1.0 gallons per hour at 20-30 psi. To prevent the nozzle from plugging up, filters should be incorporated in the water supply line.

In a third method, air passes through a coarse mesh absorbent material that is saturated with water. This system is widely used for cooling at nurseries. It is similar in principle to a "swamp cooler". In this system (and the water atomizing system), the temperature of the supply water can be regulated to provide a measure of heating and cooling. Both systems also produce some free water so provisions must be made for drainage.

## Thermostats and Humidistats

In general, thermostats and humidistats are designed to open and close valves in response to pre-set temperature or humidity limits. The instrument sensors are placed in a moving air stream representative of room conditions, usually in or near the recirculation inlet. Because these instruments are programmed for either on or off, heat and humidity come in surges. Often this results in uneven and fluctuating conditions within the room.

The ideal in environmental control is to supply just enough heat and humidity to make up for losses from the room and to compensate for differences in the fresh air. Modulating thermostats do this by supplying heat continuously in proportion to the deviation from the desired temperature. Positive control of this sort can also be accomplished by hand valves, alone or in conjunction with on/off instruments. Supply line volume is thereby regulated in order to attain an equilibrium. With a thermostat, this means keeping the supply volume just below the cut-off point.

## Lighting

Many cultivated mushrooms require light for pinhead initiation and proper development of the fruitbody. In fact, such phototropic mushrooms actually twist and turn towards a light source, especially if it is dim and distant in an otherwise darkened room. Consequently, it is important to equip

---

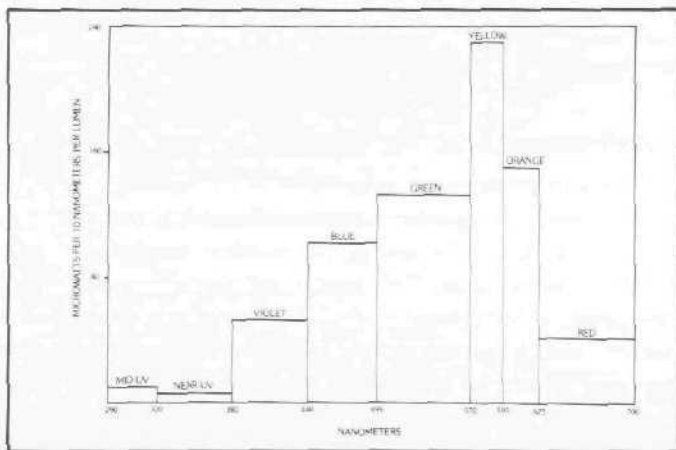
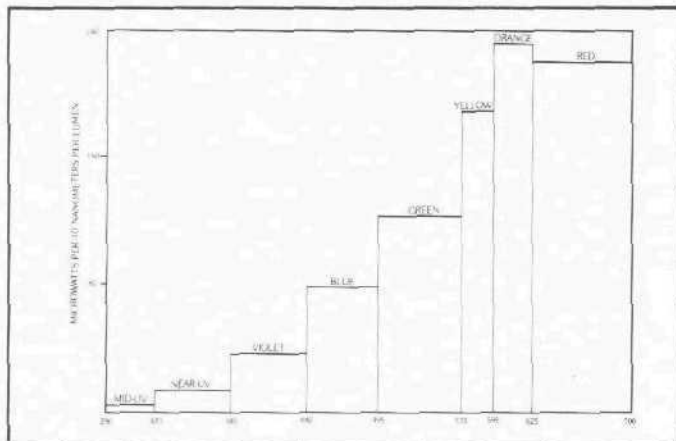
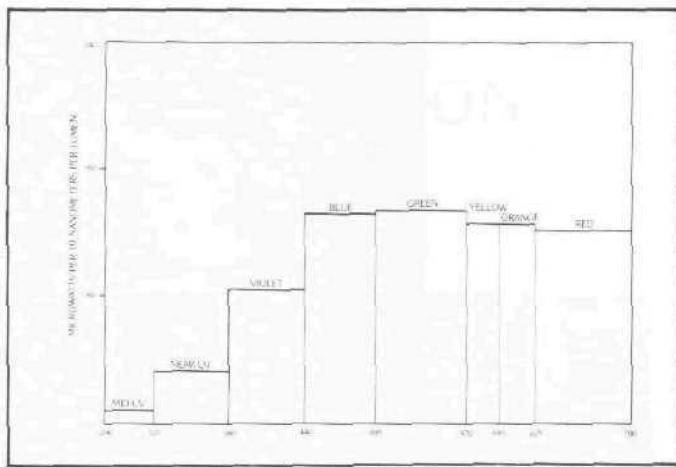

Figures 78, 79 & 80 Charts showing the proportions of spectra in incandescent, fluorescent and natural lighting.

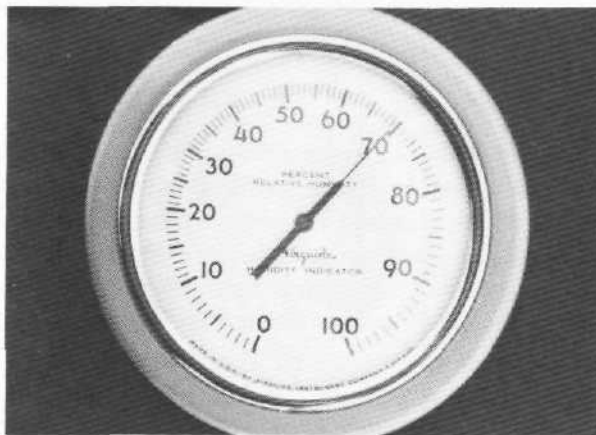

**Figure 81** An inexpensive hygrometer for measuring relative humidity.

the growing room with a lighting system that provides even illumination to all areas and levels,

Flourescent light fixtures are the most practical and give the broadest coverage. These fixtures should be evenly spaced and mounted vertically on the side walls of the room or horizontally on the ceiling above The center isle. An alternative is to mount the lights on the underside of each tier of shelf or tray, at least 18 inches above the cropping surface. To eliminate the heat and consequent drying action caused by the fixture ballasts, These can be removed and placed outside the room.

The best type of light tube is one which most closely resembles natural outdoor light: i.e. one that has at least 140 microwatts per 10 nanometer per lumen of blue spectra (440-495 nm). In contrast, warm-white flourescent light has only 40-50 microwatts/nm/lum. and cool-white has 100-110 microwatts/nm/lum. Commercial lights meeting the photo-requirements of species mentioned in this book are the "Daylite 65" kind manufactured by the Durotest Corporation and having a "color temperature" of 6500 ° K and the "Vita-Lite" flourescent at 5500 ° K. These color temperatures provide The proper amount of blue light for promoting primordia formation in *Pleurotus ostreatus*, *Psilocybe cubensis* and in other photosensitive species.

## Environmental Monitoring Equipment

Few organisms are as sensitive to fluctuations in the environment as mushrooms. A matter of a few degrees in temperature or humidity can dramatically influence the progression of fruiting and affect overall yields. To adequately monitor the growing environment, quality equipment is essential for accurate readings. This equipment should include maximum-minimum thermometers to gauge temperature fluctuations and a hygrometer or a sling psychrometer for measuring humidity. Hygrometers should be periodically calibrated with a sling psychrometer to insure accuracy. Thermometers also should be checked as there are occasional irregularities. Other more advanced, expensive but not absolutely essential equipment helpful to mushroom growers include: CO<sub>2</sub> detectors; moisture meters; anemometers; and light measuring devices.

# CHAPTER V COMPOST PREPARATION



**Figure 82** Compost pile in a standard configuration.

The purpose of composting is to prepare a nutritious medium of such characteristics that the growth of mushroom mycelium is promoted. The practical exclusion of competitor organisms. Specifically this means:

1. To create a physically and chemically homogeneous substrate.
2. To create a selective substrate, one in which the mushroom mycelium thrives better than competitor microorganisms.
3. To concentrate nutrients for use by the mushroom plant and to exhaust nutrients favored by competitors.
4. To remove the heat generating capabilities of the substrate.

Mushroom mycelium grows on a wide variety of plant matter and animal manures. These materials occur naturally in various combinations and in varying stages of decomposition. Physically and chemically they are a heterogeneous mixture containing a wide variety of insects, microorganisms and nematodes. Many of these organisms directly compete with the mushroom mycelium for the available nutrients and inhibit its growth. By composting, nutrients favored by competitors gradually diminish while nutrients available to the mushroom mycelium are accumulated. With time, the substrate becomes specific for the growth of mushrooms.

The composting process is divided into two stages, commonly called Phase I and Phase II. Each stage is designed to accomplish specific ends, these being:

**Phase I:** Termed outdoor composting, this stage involves the mixing and primary decomposition of the raw materials.

**Phase II:** Carried out indoors in specially designed rooms, the compost is pasteurized and conditioned within strict temperature zones.

## PHASE I COMPOSTING

### Basic Raw Materials

The basic raw material used for composting is cereal straw from wheat, rye, oat, barley and rye grass. Of these, wheat straw is preferred due to its more resilient nature. This characteristic helps provide structure to the compost. Other straw types, oat and barley in particular, tend to flatten out and waterlog, leading to anaerobic conditions within a compost pile. Rye grass straw is more resistant to decomposition, taking longer to compost. Given these factors and with proper management, all straw types can be used successfully.

Straw provides a compost with carbohydrates, the basic food stuffs of mushroom nutrition. Wheat straw is 36% cellulose, 25% pentosan and 16% lignin. Cellulose and pentosan are carbohydrates which upon break down yield simple sugars. These sugars supply the energy for microbial growth. Lignin, a highly resistant material also found in the heartwood of trees, is changed during composting to a "Nitrogen-rich-lignin-humus-complex", a source of protein. In essence, straw is a material with the structural and chemical properties ideal for making a mushroom compost.

When cereal straw is gathered from horse stables, it is called "horse manure". Although cultivators call it by this name, the material is actually 90% straw and 10% manure. This "horse manure" includes the droppings, urine and straw that has been bedding material. The quality of this

---

material depends on the proportions of urine and droppings present, the essential elements nitrogen, phosphorous and potassium being contained therein. The reason horse manure is favored for making compost is the fact that fully 30-40% of the droppings are comprised of living microorganisms. These microorganisms accelerate the composting process, thereby giving horse manure a decided advantage over other raw materials.

Horse manure used by commercial mushroom farms generally comes from race tracks. The bedding straw is changed frequently, producing a material that is light in urine and droppings. On the other hand, boarding stables change the bedding less, generating a heavier material. If sawdust or shavings are used in place of straw for bedding, the material should be regarded as a supplement and not as a basic starting ingredient.

When horse manure is used as the basic starting ingredient, the compost is considered a "horse manure compost" whereas "synthetic compost" refers to a compost using no horse manure. Straw, sometimes mixed with hay, is the base ingredient in synthetic composts. Because straw is low in potassium and phosphorus, these elements must be provided by supplementation and for this reason chicken manure is the standard additive for synthetic composts. No composts are made exclusively of hay because of its high cost and small fiber. In fact, mushroom growers have traditionally used waste products because they are both cheap and readily available.

By themselves horse manure or straw are insufficient for producing a nutritious compost. Nor do they decompose rapidly. They must be fortified by specific materials called supplements. In order to determine how much supplementation is necessary for a given amount of horse manure or straw based synthetic, a special formula is used. This formula insures the correct proportion of initial ingredients, which largely determines the course of the composting process. The formula is based on the Total nitrogen present in each ingredient as determined by the Kjeldhal method. By using this formula and certain composting principles, the carbon:nitrogen ratio for optimum microbial decomposition is assured. In turn, maximum nutritional value will be achieved.

## Supplements

Composting is a process of microbial decomposition. The microbes are already present in large numbers in the compost ingredients and need only the addition of water to become active. To stimulate microbial activity and enhance their growth, nutrient supplements are added to the bulk starting materials. These supplements are designed to provide protein (nitrogen) and carbohydrates to feed the ever increasing microbial populations. Microbes can use almost any nitrogen source as long as sufficient carbohydrates are readily available to supply energy for the nitrogen utilization. Because of the tough nature of cellulose, the carbohydrates in straw are not initially usable and must come from another source. A balanced supplement is therefore highly desirable. It should contain not only nitrogen but also sufficient organic matter to supply these essential carbohydrates. For this reason certain manures and animal feed meals are widely used for composting.

The following is a list of possible compost ingredients or supplements, grouped according to nitrogen content. Their use by commercial growers is largely determined by availability and cost. This list is not all inclusive and similar materials can be substituted. (See Appendix).

**Group I: High nitrogen, no organic matter**

Ammonium sulfate—21% N

Ammonium nitrate—26% N

Urea—46% N

Maximum rate—25 lbs/dry ton of starting materials

These are inorganic compounds that supply a rapid burst of ammonia. They are frequently used for initial straw softening in synthetic composts. When used, care should be taken that they are applied evenly. If ammonium sulfate is used, calcium carbonate must also be added at a rate of 3 parts  $\text{CaCO}_3$  to 1, to neutralize sulfuric acid groups. These supplements are not recommended for horse manure composts.

**Group II: 10-14% N**

Blood Meal—13.5% N

Fish Meal—10.5% N

These materials consist mainly of proteins but because of their high cost are rarely used.

**Group III: 3-7% N**

Malt sprouts—4% N

Brewers' grains—3.5% N

Cottonseed meal—6.5% N

Peanut meal—6.5% N

Chicken manure—3.6% N

This group contains the materials most widely used by commercial growers and is characterized by a favorable carbon:nitrogen balance. Dried chicken manure from broilers mixed with sawdust is commonly used and easy to handle.

**Group IV: Low nitrogen, high carbohydrate**

Grape pomace—1.5% N

Sugar beet pulp—1.5% N

Potato pulp—1% N

Apple pomace—0.7% N

Molasses - 0.5% N

Cottonseed hulls—1% N

These materials are excellent temperature boosters and for this reason are a recommended additive to all composts. They can be added to any compost formula at a rate of 250 lbs per dry ton of ingredients. Cottonseed hulls are an excellent structural additive.

**Group V: Animal manures**

Cow manure—0.5% N

Pig manure—0.3-0.8% N

These manures are rarely used for composting, except in areas without horses or chickens. They have been used with success and should be considered supplements to a synthetic blend.

---



**Group VI: Hay**

Alfalfa—2.0-2.5% N

Clover—2% N

Hay is useful for boosting initial temperatures in synthetic composts. Hay contains substantial quantities of carbohydrates which help build the microbial population. Yet another advantage is the relatively high nitrogen content in alfalfa and clover. Use at a rate of 20% of the basic starting material (dry weight).

**Group VII: Minerals****Gypsum—Calcium sulfate**

Gypsum is an essential element for all composts. Its action, largely chemical in nature, facilitates proper composting. Its effects are:

1. To improve the physical structure of the compost by causing aggregation of colloidal particles. This produces a more granular, open structure which results in larger air spaces and improved aeration.
2. To increase the water holding capacity, while decreasing the danger of over-wetting. Loose water is bound to the straw by colloidal particles.
3. To counteract harmfully high concentrations of the elements K, Mg, P and Na should they occur, thereby preventing a greasy condition in the compost.
4. To supply the calcium necessary for mushroom metabolism.

Gypsum should be added at a rate of 50-100 lbs per dry ton of ingredients. When supplementing with chicken manure, it is advisable to use The high rate.

**Limestone flour—Calcium carbonate**

Limestone is used when one or more supplements are very acidic and need to be buffered. A good example of this is grape pomace, which has a pH of 4. Because it is added in large quantities, grape pomace could affect the composting process which normally occurs under alkaline conditions.

**Group VIII: Starting materials**

Horse manure—0.9-1.2% N

Straw, all types—0.5-0.7% N

**Compost Formulas**

The following formulas for high yield compost are commercially proven. If an ingredient is not available locally, substitute one that is. The aim of the formula is to achieve a nitrogen content of 1.5-1.7% at the initial make-up of the compost pile.

In order for these formulas to be effective, the moisture content and nitrogen content must be correct. Moisture level is determined by weighing 1 00 grams of the material, drying it in an oven at 200° F. for several hours, and then reweighing it. The difference is the percent moisture. Be sure the sample is representative. The nitrogen content (protein divided by 6.25) is always listed with

commercial materials because they are priced according to percentage of protein. On the other hand, barnyard materials vary considerably with age. The more a material breaks down, the more nitrogen it loses. Most compost supplements are purchased dry and added dry, helping even distribution as well as enabling easy storage. It is also important that the raw materials used for composting be as fresh as possible. This insures maximum utilization of their properties. Baled straw stored for a year and kept dry is fine. If the straw has gotten wet, moldy or otherwise started to decompose, it should not be used.

#### Formula I

Ingredient	Wet wt.	%H <sub>2</sub> O	Dry wt.	%N	lbs.
Horse manure	2,000	50	1,000	1.0	10
Cottonseed meal	30	10	117	6.5	8
Gypsum	50		50	—	—
			1,167		18

$$(18) \div (1,167) = 1.54\%N$$

This formula makes approximately 2800 pounds of compost at a 70% moisture content.

#### Formula II

Ingredient	Wet wt.	%H <sub>2</sub> O	Dry wt.	%N	lbs.N
Wheat straw	2,000	10	1,800	0.5	9
Chicken manure	2,000	20	1,600	3.00	48
Gypsum	125	—	125		—
			3,525		57

$$(57) \div (3,525) = 1.62\%N$$

This formula make approximately 7,000 pounds of compost at a 71% moisture content.

Although 7,000 pounds of compost seems like a large quantity, at a fill level of 20 pounds per sq. ft., this will fill only 350 sq. ft. of beds or trays. Keep in mind that during the composting process there is a gradual reduction in the the total volume of raw materials. Fully 20-30% of the dry matter is consumed during Phase I and another 10-15% during Phase II. **In total, approximately 40% of the dry matter is reduced by microbial and chemical processes.** This loss of potential nutrients can not be avoided and demonstrates the importance of composting no longer than necessary.

### Ammonia

The production of ammonia is essential to the composting process. Just as the carbohydrates must be in a form that microbes can utilize, so must the nitrogen.

1. Ammonia supplies nitrogen for microbial use.
2. Ammonia is produced by microbes acting upon the protein contained in the supplements. With the energy supplied by readily available carbohydrates, microbes use the ammonia to

form body tissues. A microbial succession of generations is established, with each new generation decomposing the remains of the previous one. Microbial action also fixes a certain amount of the ammonia, forming the "nitrogen-rich-lignin-humus-complex". Unused ammonia volatilizes into the atmosphere. The smell of ammonia should be evident throughout Phase I, reaching a peak at filling.

## Carbon:Nitrogen Ratio

The importance of a carbon:nitrogen balance cannot be underestimated. A well balanced compost holds an optimum nutritional level for microbial growth. An imbalance slows and impedes this growth. It is the compost formula that enables the grower to achieve the correct C:N balance. Because organic matter is reduced during composting, the C:N ratio gradually decreases. Approximate values are: 30:1 at make-up; 20:1 at filling; and 17:1 at spawning.

1. Over-supplementation with nitrogen results in prolonged ammonia release.
2. Over-supplementation with carbohydrates results in residual carbon compounds.

Prolonged ammonia release from an over-supplemented compost necessitates longer composting times. If composting continues too long, the physical structure and nutritional qualities are negatively affected. If the ammonia persists, the compost becomes unsuitable for mycelial growth.

Readily available carbohydrates which are not consumed by the microbes during composting can become food for competitors. It is therefore important that these compounds are no longer present when composting is finished.

## Water and Air

Water is the most important component in the composting process. To a large degree water governs the level of microbial activity. In turn, this activity determines the amount of heat generated within the compost pile because the microorganisms can only take up nutrients in solution. Not only do the microorganisms need water to thrive, but they also need oxygen. Years of practice and research have established a basic relationship between the amount of water added and the aeration of the compost. **An inverse relationship exists between the amount of water and the amount of oxygen in a compost pile.**

1. Too much water = too little air  
Moisture content 75% or above.
2. Too little water = too much air  
Moisture content 67% or below

Overwetting a compost causes the air spaces to fill with water. Oxygen is unable to penetrate, causing an anaerobic condition. In contrast, insufficient water results in a compost that is too airy. Beneficial high temperatures are never reached because the heat generated is quickly convected away.



**Figure 83** Pre-wetted raw materials in a windrow.

Compost microorganisms can be divided into two classes according to their oxygen requirements. Those needing oxygen to live and grow are called **Aerobes** while those living in the absence of oxygen are called **Anaerobes**. Each class has well defined characteristics.

1. Aerobes decompose organic matter rapidly and completely with a corresponding *production* of  $\text{CO}_2$ , water and heat. This heat generation is called **Thermogenesis**.
2. Anaerobes partially decompose organic matter, producing not only  $\text{CO}_2$  and water, but also certain organic acids and several types of gases such as hydrogen sulfide and methane. Anaerobes generate less heat than aerobes.

Examination of anaerobic areas of the compost reveals a yellowish, under-composted material that smells like rotten eggs. These areas in a compost pile are noticeably cooler and generally water-logged. Anaerobic compost is unsuitable for mushroom growth.

Since neither fresh horse manure nor straw based synthetics have the *correct moisture* content, water must be added to these materials. The recommended levels for optimum composting are:

Horse manure: 69-71 %

Synthetic: 71-73%

## Pre-wetting

As long as the composting ingredients remain dry, the microorganisms lie dormant and composting does not take place. The first step in the composting process is the *initial* watering of the starting materials. The purpose of this *pre-composting* or pre-wetting is to activate the microbes.

Once activated, the microbes begin to **attack** the straw and decompose the waxy film which encases the straw **fibers**. Until this film is degraded, water will not **penetrate the straw** and its nutrients will remain **unavailable**. As the process progresses, the fibers become **increasingly** receptive to water, which **rather than being free or on The surface**, penetrates and is absorbed **into** the straw.

There are many methods for pre-wetting. These include: dipping or dunking the material into a tank of water; spraying it with a hose; or spreading it **out** in a flat pile 2-3 feet high and running a sprinkler over it. Regardless of the method used, the result should be the **same**—a homogeneous evenly wetted pile.

Horse manure needs less time for pre-wetting due to the nature of the bedding straw. This straw has been trampled upon, **opening** the straw fiber and damaging the waxy film. The urine and droppings have also begun to soften it. This is not the case with a synthetic compost in which the baled straw is still fresh and tough. To stimulate microbial action in synthetics, some supplements are added at pre-wetting. **Suitable** supplements include any from group 1, 4, 5 or chicken manure.

The length of time needed for pre-wetting varies according to the condition of the starting materials. Generally 3 days for horse manure and 5-12 days for a synthetic compost is sufficient. The **pre-wetting** time for a synthetic compost can be shortened if the straw is mechanically chopped, but care should be taken that the fibers do not become too short.

The wetted **materials** are then piled in a large rounded heap called a windrow. During this period the windrow can be turned and re-wetted as needed, usually 1 -3 times.

## Building the Pile

Building the compost **pile** is called stacking, ricking or "make-up". At this time the **pre-wetted** starting materials and the nitrogenous supplements are evenly **mixed**, watered and assembled into a pile. The size, shape and specific physical properties of this pile are very important for optimum composting. These are:

1. Pile dimensions should be 5-6 feet wide by 4-6 feet high. The shape should be rectangular or square.
2. The side of the pile should be **vertical** and **compressed** from the outside by 3-6 inches. The internal section should be less dense than the outer section.
3. The pile is such that any further increase in size would result in an anaerobic core.

Throughout the **composting** process, the size of the **pile** varies depending on the physical condition of the straw, which provides the pile's basic **structure**. The structure of the compost refers to the physical interaction of raw materials, especially the straw fibers. As the straw degrades and the **fibers flatten** out, the structure becomes more dense and the airflow is restricted. The pile becomes more compact and its size is reduced accordingly. **Initially** the fresh straw allows for generous air penetration which convects away heat and slows microbial action. To counteract this heat loss, the **pile** should be of maximum size and optimum moisture content at **make-up**.

Figure 85 illustrates air penetration of a compost pile. Air enters the pile from the sides. As the

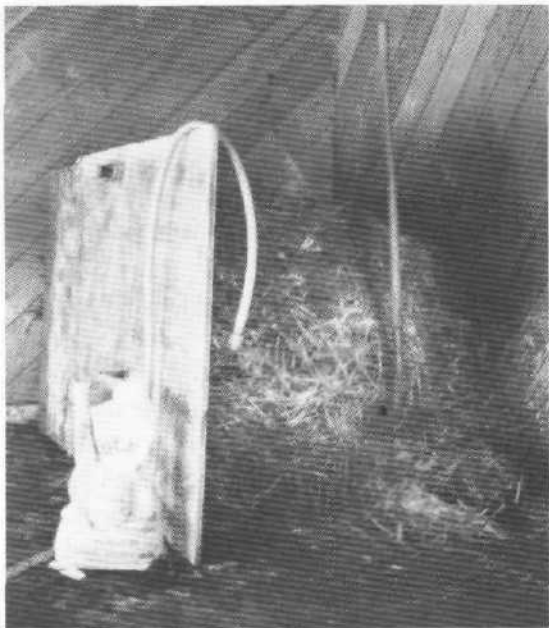
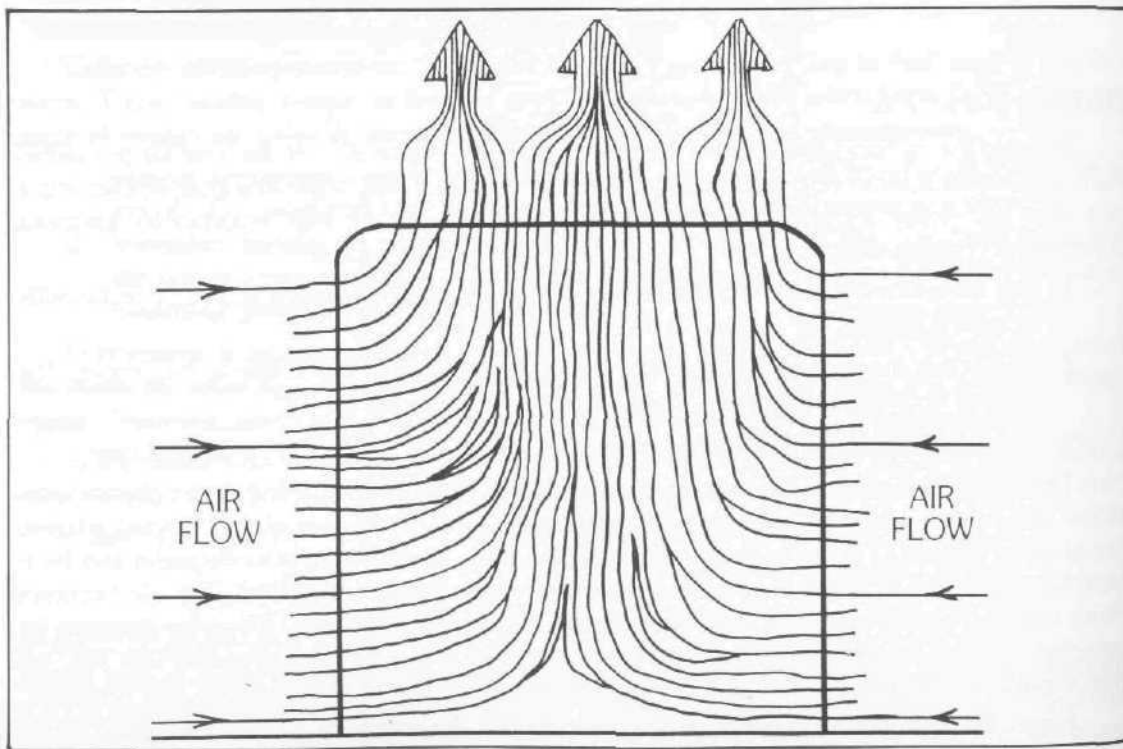

Figure 84 Ricking the compost pile.

Figure 85 Chimney effect in a compost pile.



oxygen is used by microorganisms, heat is set free and the air temperature rises. The warm air current created rises to the top of the pile. This is called the chimney effect. The factors that affect the rate of internal air flow are pile size and structure, moisture content and the differential between ambient air and internal pile temperatures.

## Turning

A well built compost pile runs out of oxygen in 48 to 96 hours and then enters an anaerobic state. To prevent this, the pile should be disassembled and then reassembled. The purposes of this turning procedure are:

1. To aerate the pile, preventing anaerobic composting.
2. To add water lost through evaporation.
3. To mix in supplements as required.
4. To fully mix the compost, preventing uneven decomposition.

As a consequence of microbial decomposition, the compost pile begins to shrink and becomes more compact. Coupled with loose water gravitating downward and water generated by microbes in the inner active areas, this compaction closes the air spaces and stifles aerobic action, particularly in the core at the bottom center. Through the use of a long stemmed thermometer reaching to the center of the pile, the time of oxygen depletion can be monitored by watching temperature. When the temperature begins to drop, indicating a slowing of microbial action, it is time to turn the compost.



Figure 86 Turning the compost pile using wire mesh pile formers.

In the early stages the temperature stratification in the pile is quite pronounced. Outer areas are cool and dry from the air flowing inward and the accompanying evaporation. These outer areas are watered during turning and moved to the center of the newly built pile and the center areas are relocated to the outside. Being aware of the varied rate of decomposition in a stratified pile and compensating during turning maintains the important homogeneous character of the pile.

Supplements deleted at make-up should be added during the turning cycle. Gypsum is normally added at the second turn. Adding gypsum any earlier is believed to depress ammonia production. Until some decomposition has occurred, the beneficial action of gypsum will not be realized. As with other supplements, gypsum is mixed in as evenly as possible.

## Temperature

Environmental conditions in the compost are specifically designed to facilitate growth of beneficial aerobic microorganisms. Given the proper balance of raw materials, air and water, a continuous succession of microbial populations produces temperatures up to 180 °F. These microbes can be divided into two groups according to their temperature requirements. Mesophiles are active under 90 °F. and thermophiles are active from 90-160 °F. The action of these microbial groups during the composting process is summarized in the following paragraphs.

During pre-composting mesophilic bacteria and fungi, utilizing available carbohydrates, attack

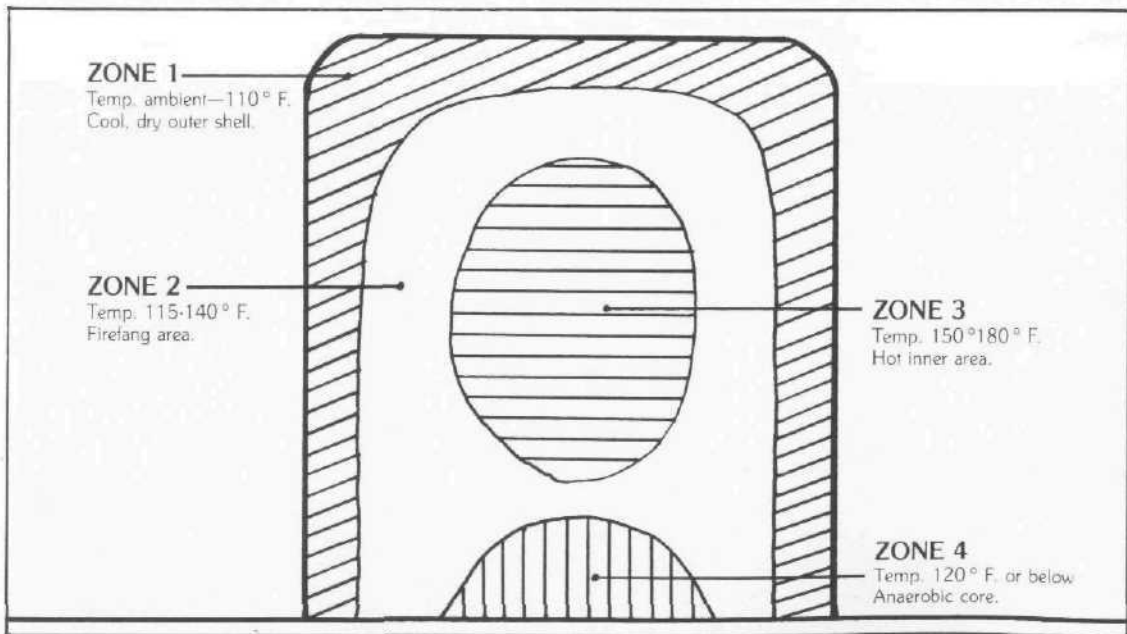

Figure 87 Standard temperature zonation in a compost pile.



the nitrogenous compounds thereby releasing ammonia. This ammonia is then utilized by successive microbial populations and the temperature rises.

After make-up, the mesophiles remain in the cool outer zones while the thermophilic fungi, actinomycetes and bacteria dominate the inside of the pile. The actinomycetes are clearly visible as whitish flecks forming a distinct ring around the hot center. Bacteria dominate this center area and continue to decompose the nitrogenous supplements, liberating more ammonia. At this point the carbohydrates in the straw are ready for microbial use.

At temperatures over 150°F., microbial action slows and chemical processes begin. Between 150-165°F. microbial and chemical actions occur simultaneously. From 165-180°F. decomposition is mainly due to the chemical reactions of humification and caramellization, the latter taking place under conditions of high temperature, high pH (8.5) and in the presence of ammonia and oxygen. Many of the dark compounds produced during composting are believed to result from these chemical reactions. Decomposition proceeds rapidly at these high temperatures, and if they can be maintained throughout the process, composting time will be greatly reduced.

Figure 87 shows the temperature zonation commonly found in a compost pile. Studies by Dr. E.B. Lambert in the 1930's showed that compost taken from **zone 2** produced the highest yielding crops. Based on this research, growers always subject their compost to **zone 2** conditions prior to spawning. This normally occurs during Phase II in specially designed rooms. However, if a Phase II room can not be built, zone 2 conditions can be achieved by an alternate method known as Long Composting, developed by C. Riber Rasmussen of Denmark.

## Long Composting

Long composting is designed to carry out the complete composting process outdoors (excluding pasteurization). The method is characterized by the avoidance of high temperature chemical decomposition and a reliance on purely microbial action. Specifically this procedure is designed to promote the growth of actinomycetes and rid the compost of all ammonia by the time of filling. The temperature zonation desired in this method is illustrated in Figure 88. An outline of the Long Composting procedure follows.

DAY	LONG COMPOSTING PROCEDURE
-10	<b>For synthetic composts:</b> Break the straw bales and water them thoroughly. Mix in group 1, 4 or 5 supplements or chicken manure. Windrow. Start at day -5 if straw is short or has been chopped.
-5	<b>For synthetic composts:</b> Turn and add more water. Break up any concentrations of supplements. Windrow.
-2	<b>For horse manure or synthetic composts:</b> Thoroughly wet and mix all raw materials and supplements (except gypsum). Windrow.
0	<b>Make up the pile.</b> Dimensions should be 6 feet wide and 4 feet high. The vertical sides

should be tightly compressed with the middle of the pile remaining loose. Use the pile formers to make the stack and stomp the sides from the top to achieve ample compression. Water dry areas.

- 6 **First turn:** Water as needed. Move the center anaerobic zone to the outside of the new pile and the outside zone to the center. Keep the pile height and length constant by reducing the width as decomposition proceeds.
- 10-12 **Second turn:** Add the gypsum and water as needed. Distribute the zone of actinomycetes evenly throughout.
- 13-15 **Third turn:** The actinomycete zone should be evident throughout. Strong actinomycete growth may cause excessive drying, so be sure to check moisture content and water as needed. The smell of ammonia should be slight. Build the new pile only 24 inches high and 4-5 feet wide. Distribute the actinomycetes evenly throughout.
- 15-17 **Fourth turn:** The compost should now appear dark brown and well flecked with actinomycetes. All traces of ammonia should be gone. Moisture content should be approximately 67-70% and the pH 7.0-7.5. If this is not the case, continue the process turning at 2 day intervals until this condition is reached. The pile height may vary between 16-24 inches and is designed solely to promote optimum conditions for the growth of the actinomycetes—temperatures of 120-135 °F.

Once finished, this compost is normally pasteurized at 135 °F. for four hours. If pasteurization is impossible, discard the cool outer shell and utilize the areas showing strong actinomycete activity. Although these areas will not be free from all pests and competitors, they should provide a reasonably productive substrate. The aspect and characteristics of a properly prepared Long Compost should conform to the guidelines for compost after Phase II. (See Aspect of the Finished Compost on page 105 and Color Plate 8).

## Short Composting

Commercial *Agaricus* growers uniformly base their composting procedures on the methodology developed by Dr. James Sinden, who called his technique "Short Composting" in reference to the short period of time involved. Dr. Sinden's process is centered around the fast acting chemical reactions occurring in zone 3. Besides the shorter preparation time, this process also results in a greater preservation of dry matter, thus retaining valuable nutrients. Figure 89 illustrates the zonation during short composting.

Without commercial composting equipment, approximating the temperature conditions of Short Composting is very difficult. However, it does provide a model for optimum composting and can be approached by adhering to the basic principles discussed in this chapter. The Short Composting procedure is outlined below.

---

**DAY SHORT COMPOSTING PROCEDURE: Formula 1**

- 1 **For horse manure:** Wet the starting materials thoroughly. Windrow.
- 0 **Make up the pile.** Add all supplements except gypsum. Mix and water thoroughly. Pile should be 6 feet wide by 5-6 feet high. The sides should be vertical and compressed tightly.
- 2,3 **First turn:** Add gypsum and water as needed. Keep the pile height constant and vary the width only in relation to the amount of anaerobic material.
- 5 **Second turn:** Add water as needed.
- 7 **Third turn:** Add water as needed. Compost should be ready to fill.

The procedures for making a synthetic compost by the short composting method are outlined below, with minor modifications for the home cultivator. Note the longer period of pre-composting to condition the straw.

**DAY SYNTHETIC COMPOSTING PROCEDURE: Formula 2**

- 10 Break straw bales and wet thoroughly. Windrow or spread out in a low flat pile, 2-3 feet high. Water daily.
- 7 Mix the chicken manure together with the straw, wetting both well. Avoid water run-off. Windrow.
- 3 Re-mix the windrow, adding water as necessary. Start here if chopped straw is used—wet the straw and chicken manure. Mix well and windrow.
- 0 **Make up the pile.** Dimensions should be 6 feet wide by 5 feet high. Add as much water as possible without run-off. Use pile formers to insure vertical sides and stomp

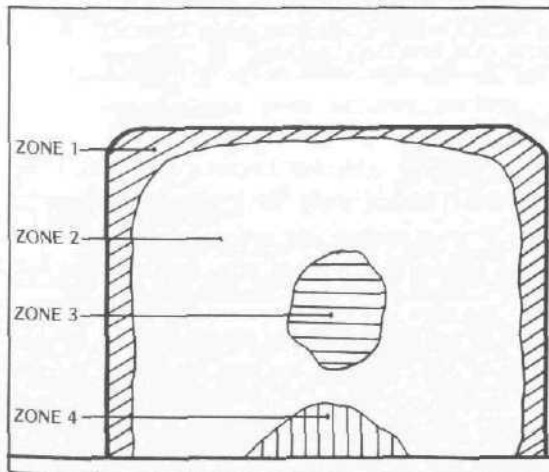

**Figure 88** Temperature zonation during Long Composting.

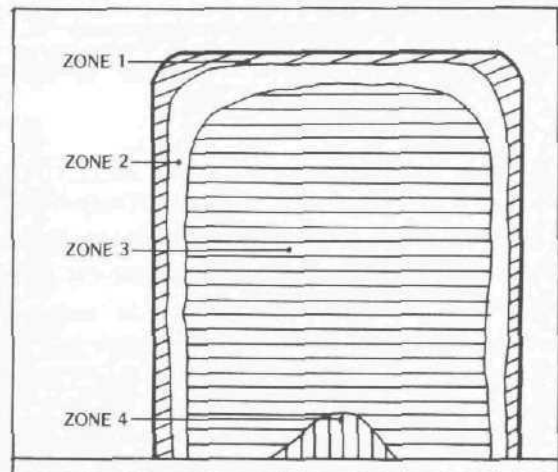

**Figure 89** Temperature zonation during Short Composting.

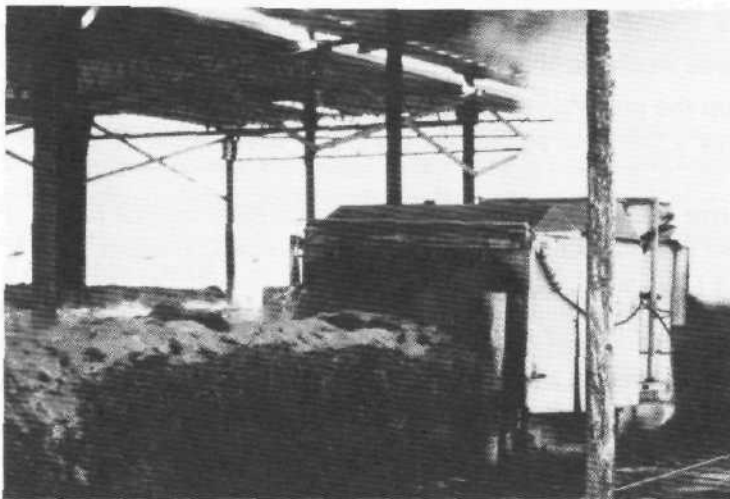

**Figure 90 Commercial compost turning machine.**

down the sides from the top to achieve adequate compression. The pile should be tight and compact.

- 4 **First turn:** Add the gypsum. Water as needed. Keep the pile dimensions constant, varying the width as indicated by the amount of anaerobic material in the center. Maintain pile compaction.
- 7 **Second turn:** Water as needed and redistribute outer and inner areas. Redistribution should occur during each turn to keep the material in an even state of decomposition.
- 10 **Third turn:** Mix well and add water as needed. Reduce width to 5 feet. Fill if ready.
- 13 Fill if ready, or continue composting, turning at two day intervals.

## Composting Tools

Since commercial growers work with many Tons of compost, a bucket loader is essential. They also use a specially designed machine for turning the piles. This compost turner can travel through a 200 foot pile in a little over one hour, mixing in supplements and adding water. Small scale cultivators can make compost without these machines. The following is a list of tools and facilities that are basic to compost preparation.

1. **A cement floor.** Not absolutely necessary but highly desirable, a cement floor is easy to work on, prevents migration of water to the earth and prevents soil and unwanted soil organisms from contaminating the pile. Water leaching from the pile, a good indicator of compost moistures, is quite evident on a cement floor. If a cement floor is not available, a sheet of heavy plastic can be used.
2. **Bobcat or small tractor loader with 3/4-1 yard bucket with fork.** If producing large amounts of compost, one of these machines saves time and labor. Not only do they make



**Figure 91** Pile formers in use.

pre-wetting, supplementing and pile building easier, they can be used to turn the pile.

3. **Pile formers.** These are constructed from 2 x 4's and plywood or planks to the dimensions desired for the compost pile. One for each side is necessary. Standard size would be 4-5 feet high by 8 feet long. An alternative to pile formers is a three sided bin.
4. **Long handled pitchfork with 4 or 5 prongs.** The basic tool in a compost yard, all compost piles were turned with pitchforks before the advent of compost turners and bucket loaders.
5. **Flat bladed shovel.** Used for handling supplements.
6. **Hose with spray nozzle, or sprinkler.**
7. **Thermometers.** Although pile temperatures can be gauged by touch, a long stemmed thermometer gives accurate readings.

### Characteristics of the Compost at Filling

The composting materials undergo very distinct changes during Phase I. A judgment as to the suitability of the compost for filling is based on color, texture and odor. Gradual darkening of the straw and the pronounced scent of ammonia are the most obvious features. These and other characteristics provide important guidelines for judging the right time for filling the compost. (Note: these guidelines do not apply for a compost prepared by the Long Composting methods.)

The compost is ready for filling if:

1. Compost is uniformly deep brown.
2. Straw is still long and fibrous, but can be sheared with some resistance.
3. When the compost is firmly squeezed, liquid appears between the fingers.

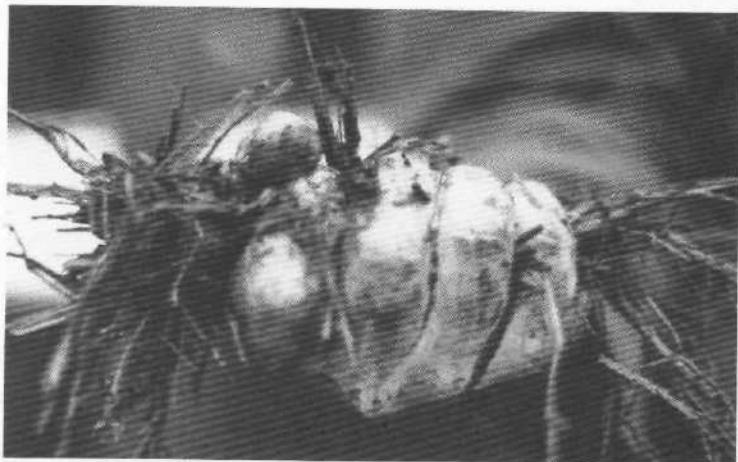

Figure 92, 93 Compost at filling can be sheared with moderate resistance.

Figure 94 Compost at filling should release some moisture when firmly squeezed.

4. Compost has a strong smell of ammonia, pH of 8.0-8.5.
5. Compost is lightly flecked with whitish colonies of actinomycetes.
6. Kjeldahl nitrogen is 1.5% for horse manure and 1.7% for synthetic composts.

## Supplementation at Filling

The key to a successful Phase II, whether in trays, shelves or a bulk room, lies in the heat generating capabilities of the completed Phase I compost. To this end the compost should be biologically "active," a term that describes a compost with sufficient food reserves to sustain a high level of microbial activity. Whereas the Sinden Short Compost is a model of a vitally active compost, the Rasmussen Long Compost is considered biologically "dead" because these food reserves have been deliberately exhausted during Phase I. In this same sense, a compost having completed the Phase II is also considered a dead compost.

A method that insures a high level of microbial activity during the Phase II is supplementation with highly soluble carbohydrates during Phase I or with vegetable oils (fats) at filling. The purpose of these supplements is to provide readily available nutrients which stimulate the growth of the microbial populations. The effect of carbohydrates or oil supplementation on the Phase II is:

1. Accelerated thermogenesis—The nutrients provided by the supplements act as a "super-charger" for the microbial populations. Consequently their increased activity generates more heat. Specifically, supplementation with vegetable oil (cottonseed oil) increased populations of actinomycetes and thermophilic fungi (Schisler and Patton, 1970) while soluble carbohydrates (molasses) enhanced bacterial populations (Hayes and Randle, 1968).
2. Better compost ventilation—Heightened thermogenesis within the compost requires lower air temperatures within the Phase II room. The greater the compost to air temperature differential, the better the air movement through the compost. In this respect a dead compost requires a high room temperature and is difficult to condition because of its low microbial activity.
3. Rapid reduction of free ammonia—The increased ventilation and microbial activity give rise to a rapid fixation of ammonia. As a result, the Phase II period is reduced by as much as three days. The advantage of this reduced time period is that dry matter and hence nutrients for mushroom growth are conserved.
4. Reduced spawn running period—Oil supplemented composts show increased mycelial activity and therefore higher temperatures during the spawn running period. As a result the colonization period is shortened by three to five days.
5. Increased yields—Yield increases of 0.4-0.5 lbs/ft<sup>2</sup> are common for *Agaricus* growers using vegetable oil at filling. Similar increases are reported for molasses.

Compost supplementation with soluble carbohydrates is an effective way to prepare an active compost. These materials are listed earlier in the chapter as Group IV supplements. They are added to a synthetic compost during pre-composting (50%) and at third turn (50%) and to a horse manure compost at make-up and at third turn. Molasses is added at make-up at a rate of 10 ml per pound of

compost wet weight and is diluted 1:2 with water for easy application. Vegetable oil is sprayed onto the compost the day of fill at a rate of 10 ml per pound of compost wet weight. Even application is important to avoid creating hot spots.

Compost supplementation with soluble carbohydrates or vegetable oils is highly recommended, especially for those planning a Phase II without steam or with only limited supplemental heating. Hence, this type of supplementation is particularly appropriate for the home cultivator.

## PHASE II COMPOSTING

While Phase I is a combination of biological and chemical processes, Phase II is purely biological. In fact, Phase II can be considered a process of microbial husbandry. By bringing the compost indoors into specially designed rooms, the environmental factors of temperature, humidity and fresh air can be controlled to such a degree that conditions for growth of select microbial groups can be maximized. These thermophilic and thermotolerant groups and their Temperature ranges are:

**Bacteria:** 100-170°F. Different species of bacteria are active throughout this range so an optimum can not be given. At temperatures above 130°F, bacteria dominate and are responsible for the ammonification that occurs at these temperatures. The most common bacteria found by researchers are *Pseudomonas* species.

**Actinomycetes:** 115-140°F. with an optimum temperature range of 125-132°F. The most common species are found in the genera *Streptomyces* and *Thermomonospora*. Work done by Stanek (1971) has shown that actinomycetes and bacteria are mutually stimulatory, resulting in greater efficiency when working together.

**Fungi:** 110-130°F. with an optimum temperature of 118-122°F. Common genera are *Humicola* and *Torula*. Recent research indicates that these fungi are the most efficient de-ammonifiers, which has led to a more general use of their temperature range for Phase II conditioning.

The basic function of these microorganisms is to utilize and thereby exhaust the readily available carbohydrates and the free ammonia. Ammonia in particular must be completely removed be-

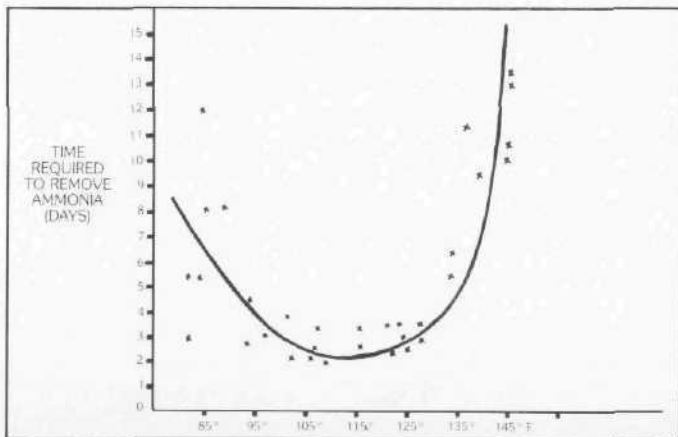

Figure 95 Temperature vs. ammonia utilization by microbial populations. (After Ross, 1978)



cause of its inhibitory effect on the growth of mushroom mycelium. The result of this microbial action is a build-up of cell substance or "biomass" which contains vitamins, fats and proteins. What the mushroom mycelium uses for a large portion of its nutrition then, is the concentrated bodies forming the microbial biomass. This biomass constitutes part of the brown layer coating the partially decomposed straw fibers.

Many growers consider Phase II to be the most important stage in the growing cycle and rightly so. An improperly prepared substrate yields few if any mushrooms. It is critical, therefore, that the environmental conditions required during Phase II be carefully maintained. Phase II can be separated into two distinct parts, each serving a specific function. These are:

1. **PASTEURIZATION:** The air and compost temperature are held at 135-140 °F. for 2-6 hours. The purpose of pasteurization is to kill or neutralize all harmful organisms in the compost, compost container and the room. These are mainly nematodes, eggs and larvae of flies, mites, harmful fungi and their spores. The length of time needed generally depends on the depth of fill. Deeper compost layers require more time than shallow ones. In general, two hours at 140 °F. is sufficient. Compost temperatures above 140 °F. must be avoided because they inactivate fungi and actinomycetes while at the same time stimulating the ammonifying bacteria. If temperatures do go above 140 °F., be sure there is a generous supply of fresh air.
2. **CONDITIONING:** The compost temperature is held at 118-130 °F. Once the pasteurization is completed, the compost temperature should be lowered gradually over 24 hours to the temperature zone favored by actinomycetes and fungi. The exact temperature varies according to the depth of fill. At depths up to 8 inches, 122 °F. as measured in the center of the compost is most frequently used. At depths over 8 inches, temperature stratification becomes more pronounced, making a higher core temperature of 128 °F. advantageous. A common procedure is to bring the compost Temperature down in steps, dropping the core temperature 2° per day, from 130° to 122 °F. This temperature is then held until all traces of ammonia are gone.

## Basic Air Requirements

Phase II is purely a process of aerobic fermentation and as such a constant supply of fresh air is essential. To insure this supply, a minimum fresh air setting is established on the air intake damper. A standard minimum setting is 8-10% of the intake opening. The oxygen level can be checked in a practical manner by lighting a match in the Phase II room. If a flame can be maintained, the oxygen level is sufficient. Lack of oxygen stimulates the growth of *Chaetomium*, the Olive Green Mold, which will spoil the compost. (See Chapter XIII).

Compost temperatures follow the air temperature of the room. Fresh air not only supplies oxygen, but is also used to keep the compost within the correct temperature zone. To drop the compost temperature, more fresh air is introduced and vice versa. Oversupply of fresh air is only a problem if it leads to rapid cooling of the compost. In this regard, changes in the fresh air setting should

be slow and deliberate. Only when the compost threatens to **overheat** should maximum fresh air be introduced. This is particularly common directly after pasteurization.

Peak microbial activity normally occurs 24-48 hours after pasteurization. As Phase II progresses and the food supply diminishes, this activity begins to slow. Compost temperatures should begin to drop on their own. As they **drop**, the fresh air supply should be decreased, thus slowly raising the air temperature as the compost reaches the required temperature zones. If the fresh air minimum is reached and the compost temperatures are still dropping, a **supplemental** heat source must be installed.

## Phase II Room Design

The Phase II room can be a special room set aside solely for this purpose (the norm on Tray farms) or it can be in the same room where cropping occurs. Design features are **critical** for its success and should be strictly adhered to. These features are:

1. Adequate insulation: Insulate to a R value of 19 for walls and a minimum of 30 for the ceiling. A vapor barrier is needed to **protect** the insulation. (A layer of polyethylene is cheap and effective.)
2. The room must be **functionally** airtight. The door should form a **tight** seal. Any cracks or openings allow The passage of flies.
3. The ventilation system uses a backward-curved centrifugal fan driven by pulleys and belts, and whose speed can be varied. The fan should be **capable** of moving air at 1 cubic foot per minute (CFM) per square foot of compost surface area. A **perforated** polythene duct runs the length of the room and directs the air either straight down the center aisle or across the ceiling to the side walls. High **velocity** airflow is necessary To maintain even Temperatures **throughout** as well as to keep The room under positive pressure.
4. A fresh air vent is located before the fan. This damper also regulates recirculated air. (See Fig. 73).
5. Filters are placed before the fresh air inlet. These filters are important as protection against flies, dust and spores. High efficiency spore filters are commonly used for the incoming fresh air. A **pre-filter** placed upstream of the main filter will increase its life. Recirculated air should never be **filtered** during Phase II because of its high moisture **content**.
6. At the opposite end of the room from the fresh air vent are exhaust louvers operating on air pressure. This exhaust air outlet must be screened from the inside.
7. If steam is used for boosting **temperature**, pipes can be run the length of the floor along the side walls discharging **outwards**. Steam can also be discharged directly into the air duct after the fan. High output electric space heaters can also be used.

## Filling Procedures

Depending on the growing system chosen, the compost is loaded into trays, shelves or a bulk

---

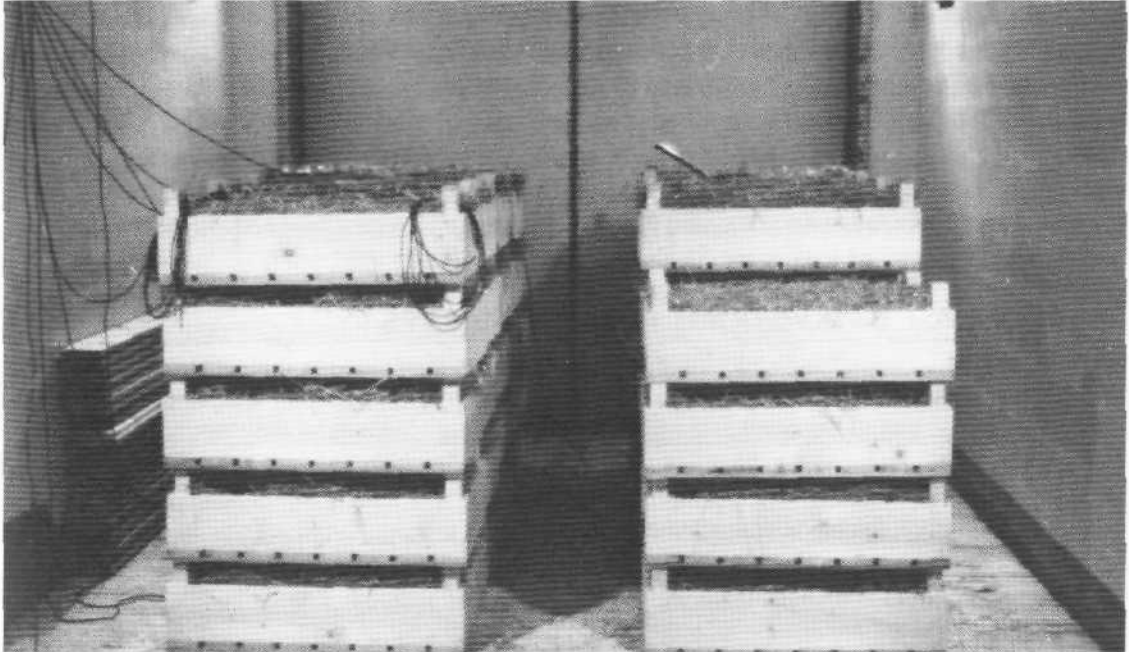

**Figure 96 Small Phase II room designed for trays or bulk fill.**

room. Certain basic principles should be adhered to when filling. These are:

1. Fill the room as quickly as possible to minimize heat loss from the compost.
2. Compress a long strawy compost and fill loosely a short dense compost.
3. If the compost appears dry, water lightly and evenly during filling. If water streams out when a handful is squeezed, don't fill. Add again as much gypsum, turn and wait a few days,
4. Fill all shelves and trays evenly and to the same depth. Avoid creating pockets of compact compost. Keep all compost within the container. No compost should hang over the sides.
5. Once finished, the floor should be cleaned of all loose compost, then washed with water.

### Depth of Fill

Up to a point there exists a direct relationship between the amount of compost filled per square foot and yield. In a fixed shelf system, the amount of compost filled is usually the amount available for cropping. This normally holds true for trays, although some systems empty the trays at spawning and then refill 25% fewer trays than the number that was originally filled. This results in high dry weight efficiencies without the complications of deep compost layers during Phase II. As a general rule, a fill depth of 8 inches will provide sufficient nutrients as well as contribute to the ease of Phase II- At depths over 8 inches temperature stratification will lead to varying conditions within the com-

post, complicating the Phase II program. At depths under 5 inches there is insufficient mass for proper heat generation and large quantities of steam may be needed.

An important consideration is the ratio of cubic feet of compost filled to cubic feet of air space in the room. This ratio largely determines whether a supplementary heating source is necessary. Clearly, greater volumes of compost require less additional heating. To maximize compost heat generation, some tray systems stack trays no more than 3-4 inches apart during Phase II. These trays are later distributed to two cropping rooms with a spacer inserted between the trays to facilitate picking.

### **PAY PHASE II PROCEDURE: TRAYS OR SHELVES**

- 0 The house is filled and cleaned. Thermometers are placed in the center of at least four containers, and one in the middle of the room for reading air temperature. Shut the

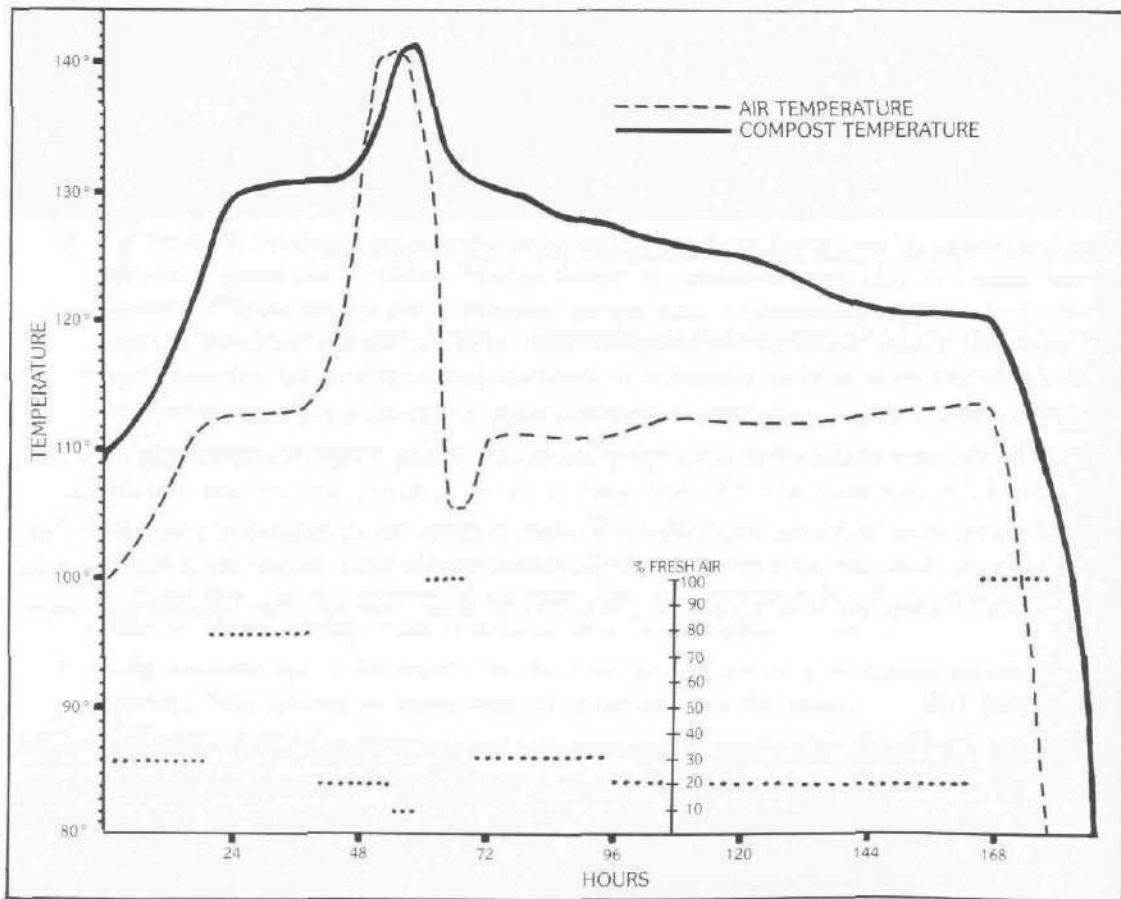

**Figure 97** Phase II temperature profile for trays or shelves.

- door, turn on the fan and close the fresh air vent. Air and compost temperatures should rise from microbial activity. If not, additional heat should be supplied. Once The compost reaches 120°F., The fresh air vent should be opened and regulated to maintain compost temperatures in the 125-130°F. range. From this point on, the fresh air vent should never be less than the minimum setting of 10%.
- 1-2 A temperature chart should be kept, noting air and compost as well as fresh air and steam settings. Temperatures should be read every 4-6 hours. Compost temperatures should be in the 125-130°F. range for the first 48 hours after fill. After this period, pasteurization should commence. The air temperature is boosted to 140°F. and held long enough to subject the compost to 140°F. for 2 hours. If 140° can not be reached, a compost and air temperature of 135° for four hours is sufficient. The temperatures should be monitored closely to be sure pasteurization is complete. A long stemmed thermometer can be pushed through a drilled opening in the door, or a remote reading thermocouple can be used. After pasteurization, full fresh air is introduced to stop rising compost temperatures. Once the compost temperature begins to drop, adjust the fresh air setting To stop the compost in the temperature zone required, 128-130°F.
- 2-10 Starting at 128°F., use fresh air to lower the compost temperature gradually, 2° per day, until 122° is reached. Hold The compost at that temperature until it is free of ammonia. Throughout this conditioning process, a compost to air differential of 10-30°F. is normal. This differential is important for The passage of air through The compost. Little or no differential is undesirable and indicates over-composting or under-supplementation. During the conditioning period definite changes in the compost become apparent. The compost becomes well flecked with whitish actinomycetes, and on the surface whitish grey aerial mycelia of *Humicola* species appear. Both are indicators of proper microbial conversion.
- 5-10 Once the compost is free of ammonia, full fresh air is introduced, dropping the compost temperature rapidly to spawning temperatures in the 76-80°F. range.

## Phase II in Bulk

For many people, equipping a standard Phase II room for trays or shelves may be inappropriate, especially if steam is used. The recent development of the bulk system now gives the home grower the ability to perform the Phase II without steam. This system utilizes compost heat more efficiently by loading the compost in mass, five feet deep, into a small well insulated room with a slatted floor. Instead of air diffusing through the compost by convection, air is blown under the floor and forced up through the compost. The wide compost to air temperature differential so essential to conventional Phase II processes is eliminated; compost and air temperatures are now no more than 5°F. apart. This narrow differential is in part related to a reduced compost-to-air volume ratio, which in a bulk room is 1:1 or 1:¾. This reduction of air space, coupled with the airtight, well insulated room, results in full utilization of compost heat generation. A large measure of control over compost

temperatures becomes possible and optimum temperatures within the mass can be tightly regulated.

## Bulk Room Design Features

The size of the bulk room varies according to individual needs, but should be large enough that there is sufficient compost mass to supply heat.

1. At a fill depth of 4-5 feet, one ton of compost requires approximately 8-10 sq. ft. of floor space.
2. Bulk rooms are well insulated. The walls and door are R-19; the ceiling is R-30 minimum. A vapor barrier should protect all insulation.
3. The room has a double floor. The bottom floor is concrete, insulated to R-19 with styrofoam or other water impervious material, and covered with tar or temperature resistant plastic as a vapor barrier. The compost floor is 12-18 inches above the bottom floor, and is made of 4 x 4's with spacers in between to leave 20% air space. This floor is removable to permit periodic cleaning.
4. The interior walls and ceiling are made of exterior grade plywood, treated with a wood preservative or marine epoxy. Allow  $\frac{1}{4}$  inch for expansion. Caulk or seal with fiberglass (ape).
5. The room must be airtight. Caulk all cracks and corners.
6. The access door runs the width of the room for easy loading and unloading. An airtight seal is essential.
7. A wood plank wall is inserted before the access door to prevent the compost from pressing against it. The plank wall is held in place by runners on either wall.
8. The ventilation system is powered by a centrifugal, high pressure belt driven blower, with a capacity of 90-120 CFM per ton of compost at a static pressure of up to 4 inches of water gauge. The recirculation duct comes out on the top of the back wall and down to the fan. The supply duct goes from the fan to the air chamber under the compost floor. All ductwork should be insulated.
9. The fresh air inlet and damper are located before the fan. This damper also regulates the recirculated air. The fresh air should be filtered.
10. The exhaust outlet is located on the access door. This is a free swinging damper that operates on room pressure. This outlet is covered by a coarse filter.
11. Standard inside dimensions are 6-12 feet wide by 8-10 feet high.
12. For better temperature control the bulk room should be built inside a larger building, like a garage, where temperature differences are less extreme. The introduction of cold fresh air hampers the process by neutralizing the compost heat.

A simple variation of this bulk room is a well insulated bin. The bin is constructed using the

---

principles just outlined. Rather than a mechanical air system, fresh air is admitted through adjustable vents at floor level and exits through similar vents in the ceiling. Because air passage is by convection, the compost should be filled loosely and to a depth of no greater than four feet.

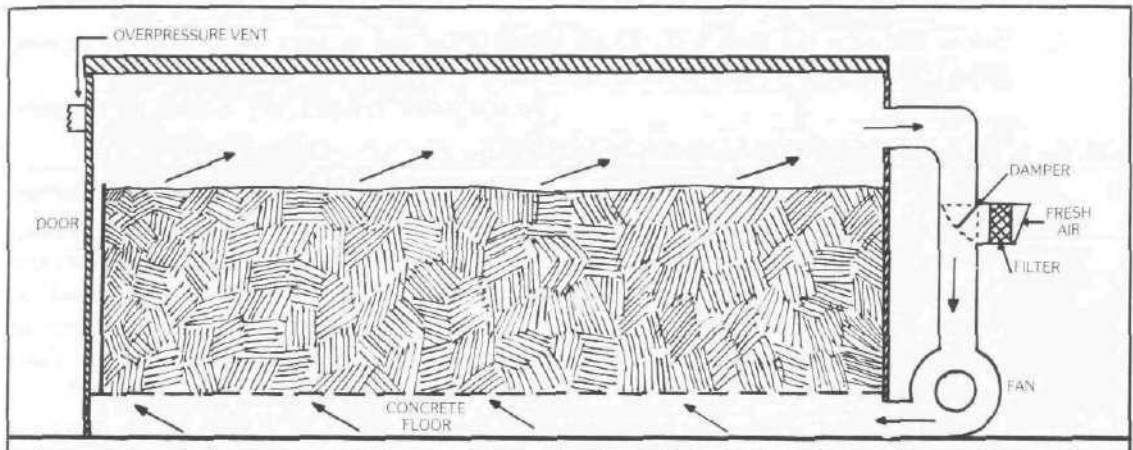

Figure 98 Bulk pasteurization room. Ventilation system on end wall. (Design—Vedder)

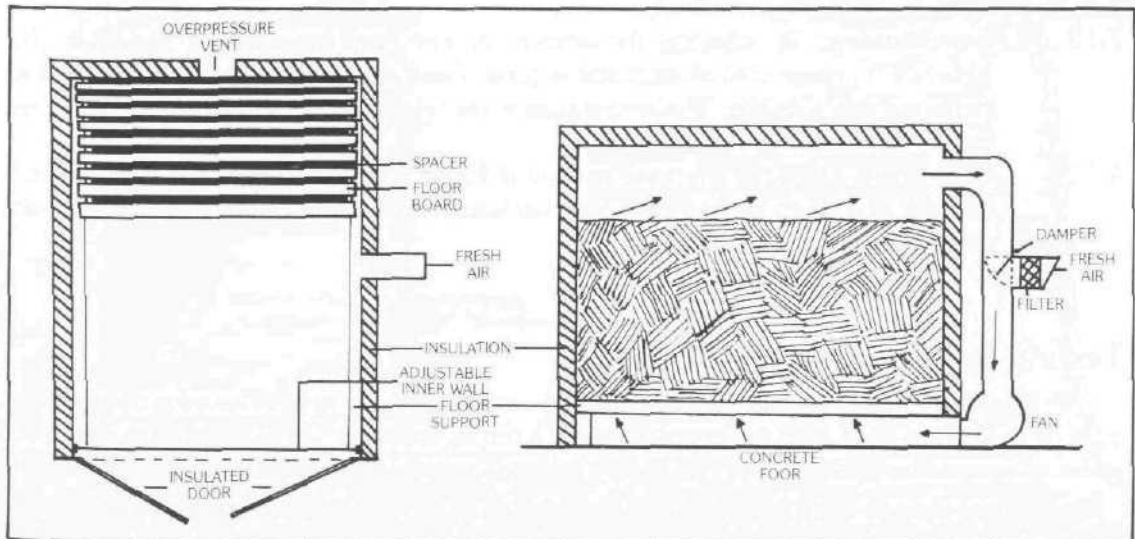

Figure 99 Bulk pasteurization room. Ventilation system on side wall. (Design—Claron)

## Bulk Room Filling Procedures

1. Fill as quickly as possible to minimize heat loss.
2. Compost should have good structure and optimum moisture content. Do not fill a dense, overwet compost.
3. Fill evenly. Compost density is important. Avoid localized compaction as well as gaps. Gaps or holes in the compost become air channels to the detriment of the surrounding material. Be sure the compost presses firmly and evenly against all sides of the room.
4. Before filling the last three feet, put the inside board wall in place. Now fill the remaining area. The compost should press firmly against the board wall.

---

### DAY      BULK ROOM PHASE II PROCEDURES

---

- 0**      **Filling.** Compost is brought into the room. If remote reading temperature sensors are used, place 2-4 sensors in different locations within the compost, and one in the air above. If remote sensors are not used, place one thermometer in the return air duct and one downstream from the fan in the supply duct. The compost temperature should be within the readings of these two air thermometers. Turn the fan on, close the fresh air damper and re-circulate until 120°F. is reached. This should take 8-24 hours. Then open the fresh air damper to the minimum setting, 8-10%.
- 1-2**      **Pasteurization:** Allow the temperature to rise to 132-135°F. Adjust the fresh air damper to hold this temperature for at least six hours and a maximum of ten hours. Once completed, introduce sufficient fresh air to bring the temperature down to 122°F. This should take approximately 12 hours. Be sure to anticipate temperature trends and adjust the fresh air accordingly.
- 2-10**      **Conditioning:** By adjusting the amount of fresh air, the compost is held in the 118-122°F. range until all ammonia is gone. Fresh air should gradually be reduced as thermogenesis subsides. The temperature in the return air duct should always be higher than in the supply duct.
- 4-10**      **Cool-down:** Once the ammonia content of the air is below 10 parts per million (ppm) full fresh air is given to reduce the compost temperature to 80°F. The cool-down should proceed as rapidly as possible.

## Testing for Ammonia

The basic ammonia detection test has always been The sense of smell. The odor of ammonia must be completely gone from The compost before it can be spawned. Odors are always good indicators of compost suitability. However, to be absolutely certain, other methods are also used.

1. Cresyl Orange and filter paper: Pre-cut strips of white filter paper are saturated with a few drops of cresyl orange liquid which turns the white paper yellow. Expose the paper to the inside of the Phase II room or to the exhaust air of the bulk room. The paper can also be
-



placed into small holes dug into the compost. The presence of ammonia turns the paper varying shades of red. Purple indicates the highest concentration, while pink indicates a lower one. When the yellow paper remains unchanged in color, free ammonia is absent.

2. Air samplers using gas detection tubes: These tubes are filled with chemicals that change color as air samples are drawn into them. The tubes are calibrated in parts per million (ppm) and give accurate readings down to 1 ppm. The air samplers are manufactured by Mine Safety Co. and the Draeger Corp. Individual tubes cost from \$2.00-\$4.00 in lots of ten. (See sources in Appendix).

## Aspect of the Finished Compost

The following guidelines can be used to determine whether a compost is ready for spawning. (See Color Photographs 5-8).

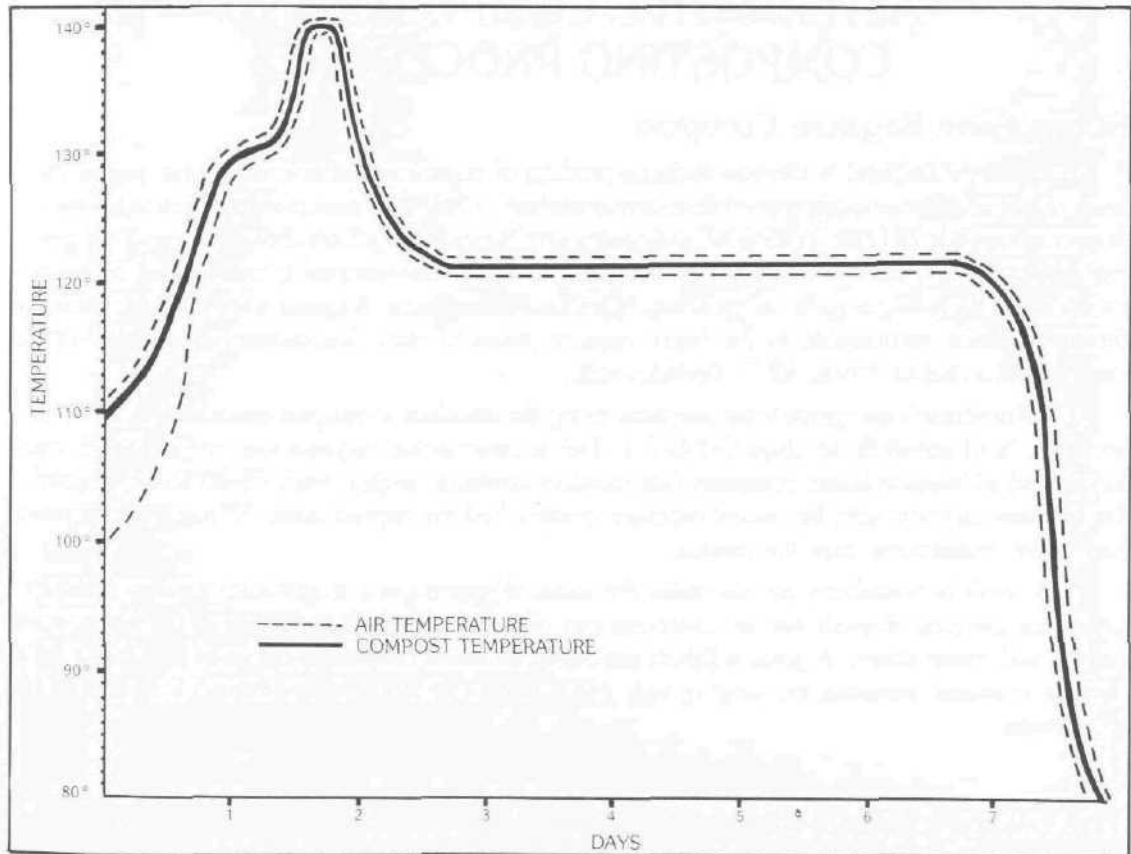

Figure 100 Bulk room Phase II temperature profile, (Dutch procedure)

1. The raw pungent odor is gone; the odor is now light and pleasant, even slightly sweet.
2. The ammonia odor is completely gone. The cresyl orange test shows no reaction. Detector tubes read 10 ppm or less.
3. The pH is below 7.8, preferably 7.5.
4. Straws appear dull and uniformly chocolate brown, speckled with whitish actinomycetes.
5. The compost is soft and pliable and can be sheared easily.
6. When squeezed the compost holds its form. No water appears and the hand remains relatively clean.
7. Moisture content is 64-66% for horse manure and 67-68% for synthetics.
8. Nitrogen content is 2.0-2.3%; the C:N ratio is 17:1.

## ALTERNATIVE COMPOSTS AND COMPOSTING PROCEDURES

### Sugar Cane Bagasse Compost

Sugar cane bagasse is the cellulosic by-product of sugar cane after most of the sugars have been removed. It is generally a short fibrous material with a high moisture holding capacity. Total nitrogen amounts to 0.18%. In 1960, Dr. Kneebone of Pennsylvania State University reported growing *Psilocybe aztecorum* on a bagasse based compost. He later reported in more detail on experiments using bagasse compost for growing *Agaricus brunnescens*. Bagasse used as stable bedding produced yields comparable to the horse manure based control. Bagasse supplemented with a commercial activator ("Acto 88") yielded poorly.

Dr. Kneebone's composts were prepared using the standard techniques elucidated in this chapter with a turn schedule on days 0-2-5-7-9. The supplemented bagasse was composted 3 days longer and all bagasse based composts had moisture contents ranging from 75-83%. Significantly, the bagasse compost with the lowest moisture content had the highest yield. All bagasse composts had larger mushrooms than the control.

This work by Kneebone demonstrates the value of bagasse as a mushroom growing substrate. Using the compost formula format, composts can be devised to meet the needs of the two species named and many others. A good supplement would be horse droppings on wood shavings. If the bagasse compost becomes too short or wet, the gypsum can be increased from 5% to 8% of the dry weight.

### The 5-Day Express Composting Method

During the past 20 years compost research has been directed towards shortening the overall preparation period. The goal is to reduce handling and further conserve the nutrient base (dry mat-

---

ter). But so far, no one has been able to consistently produce a high yielding compost by rapid preparation methods. However, a recent article by Kaj Bech (1978) of the Mushroom Research Lab in Denmark reports the most promising method to date. According to Bech, total dry matter loss is held to 20-25% with a composting time of 8-10 days (5 day Phase I and 3-5 day Phase II). His method and materials follow:

DAY	PROCEDURE
-2	Take one ton wheat straw based horse manure (moisture content 50%, nitrogen content of 1.0-1.1) Homogenize well and make up the pile using standard dimensions.
0	<b>1st turn:</b> Add ammonia sulfate, $(\text{NH}_4)_2\text{SO}_4$ , 11.25 kg. Wet thoroughly with approximately 450 liters of water.
2	<b>2nd turn:</b> add calcium carbonate $(\text{CaCO}_3)$ 33.75 kg. Add approximately 1 80 liters of water.
3	Mix well and fill Trays, shelves or tunnel for standard Phase II.

## CHAPTER VI NON-COMPOSTED SUBSTRATES



Figure 101 *Psilocybe cyanescens* fruiting outdoors in a bed of fresh alder chips.

The use of non-composted and semi-composted materials as mushroom growing substrates is common among commercial growers of *Pleurotus*, *Volvariella*, *Flammulina* and *Stropharia*. Because of the simplicity and ease by which they are produced, these substrates are ideal for the home cultivator. The advantages of these substrates are the rapid preparation times and the easily standardized mixtures formulated from readily available raw materials. These substrates can be treated by sterilization, pasteurization or used untreated in their natural state.

## NATURAL CULTURE

For most people mushroom cultivation implies an indoor process employing sterile culture techniques and a controlled growing environment. Although this has been the natural progression of events for commercial cultivators and is the only way to consistently grow year round crops, it need not be the sole method available to the home cultivator. For hundreds of years home growers have made up outdoor beds and have enjoyed harvesting seasonal crops of mushrooms. In fact, most mushrooms now being grown commercially were originally grown using natural culture techniques.

By observing wild mushrooms fruiting in their natural habitats, one can begin to understand their growth requirements. To fully illustrate how this methodology works, the development of natural culture for *Psilocybe cyanescens* will be used as an example. *Psilocybe cyanescens* grows along fence lines and hedge rows, in tall rank grass, in berry thickets, in well mulched rhododendron beds, in piles of wood chips and shavings and in ecologically disturbed areas. In many instances, the mushrooms are found growing in soil, but upon close examination of the underlying mycelial network, it is apparent that they are feeding on wood or other similar cellulosic material. Due to the thick strandy mycelium of *Psilocybe cyanescens*, it is relatively easy to locate and gather colonized

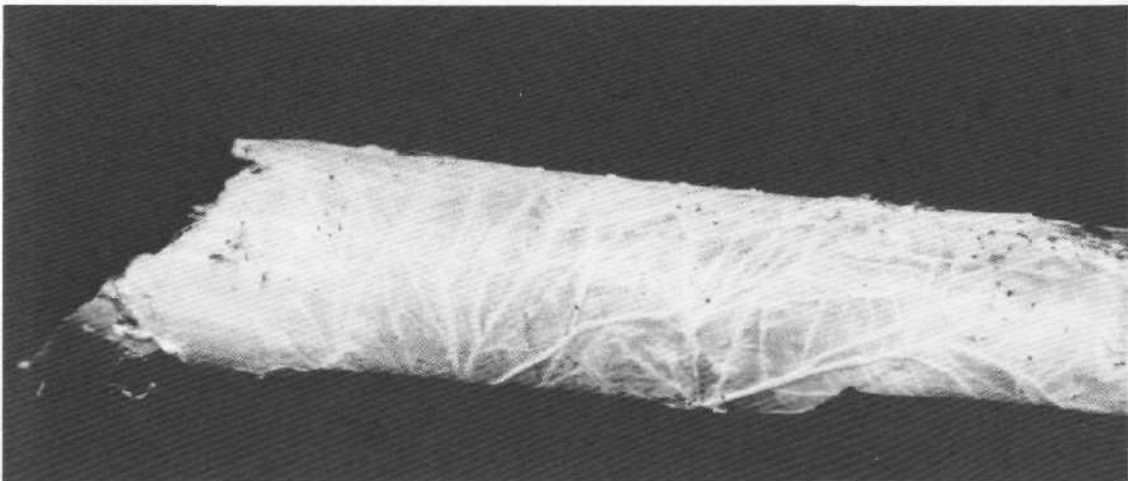

Figure 102 Virgin spawn: *Psilocybe cyanescens* mycelium on a wood chip.

pieces of substrate. These pieces are considered virgin spawn and are used to inoculate similar materials. Freshly cut chips of alder, maple and fir all support healthy mycelial growth. Because alder is high in sugar content, without resins and abundant in northwestern North America, it has been selected as the primary substrate material.

Even though such a virgin spawn is not absolutely clean, *Psilocybe cyanescens* mycelium colonizes fresh substrate pieces so rapidly that there is little risk of contamination. In order to prepare inoculum for the following year, the newly inoculated chips are kept indoors in gallon jars or other protective containers. With sufficient moisture, minimal air exchange and normal indoor temperatures, the mycelium soon spreads throughout the fresh chips. For the best results a 1:5 ratio of virgin spawn to fresh chips is recommended. As one jar becomes fully permeated, it can be used to produce more spawn.

In the spring freshly cut wood branches are chipped, then mixed with the fully colonized inoculum and made into a ridge bed directly on the ground. Experience has shown that irregular chips approximately 1-3 inches long give better results than finely ground material such as sawdust. Fresh chips not only provide a greater nutrient and water reservoir, but also have substantial surface area for primordia formation. Strong mycelial growth can be sustained on wood chips for a prolonged period of time. (Mycelial growth on fresh sawdust is at first rapid and rhizomorphic but soon slows and loses its vitality).

The ridge beds should be made 4-6 inches deep and 2 feet wide. To insure a humid microclimate for mushroom development the bed should be made under rhododendrons or other leafy ornamentals, along a fence or hedge row, or on grass which is allowed to grow up through the bed.



Figure 103 Chipping freshly cut alder branches.

The bed must never be placed where it is exposed to direct sunlight but it should not be so well protected that rainfall can not reach it.

During the spring and summer the mycelium colonizes The fresh substrate which should be covered with plastic or cardboard to prevent drying. A weekly watering helps to keep The moisture content high. In the fall the bed is uncovered and given a heavy watering Twice a week, but with care not to flood it. When the mushrooms begin to fruit, watering should be gauged according to environmental conditions and natural precipitation. As long as the temperature stays above freezing the mushrooms will grow continuously. If a freeze is expected, the beds can be protected with a plastic covering. Extended freezing weather ends outdoor cropping until the following year.

Throughout the winter the beds can be protected by a layer of straw, cardboard or new chips topped with plastic. This is particularly important for harsh climates. Other possibilities include making the bed inside a cold frame or plastic greenhouse. Certain regions of the country like the Northwest are better suited to natural culture than others. In this respect it is desirable to use a local strain adapted to local conditions. In climates unsuited To outdoor cultivation, the wood chips can be filled into trays and brought inside.

Once the primary bed has been established outdoors, it can be likened To a perennial plant, which is the nature of mushroom mycelium. Indoor spawn preparation and incubation become unnecessary. With each successive year chips can be drawn from the original bed and used as inoculum. This means that the total bed area can be multiplied by five on an annual basis. (See Figure 164 of *Psilocybe cyanescens* fruiting indoors in tray of alder chips).

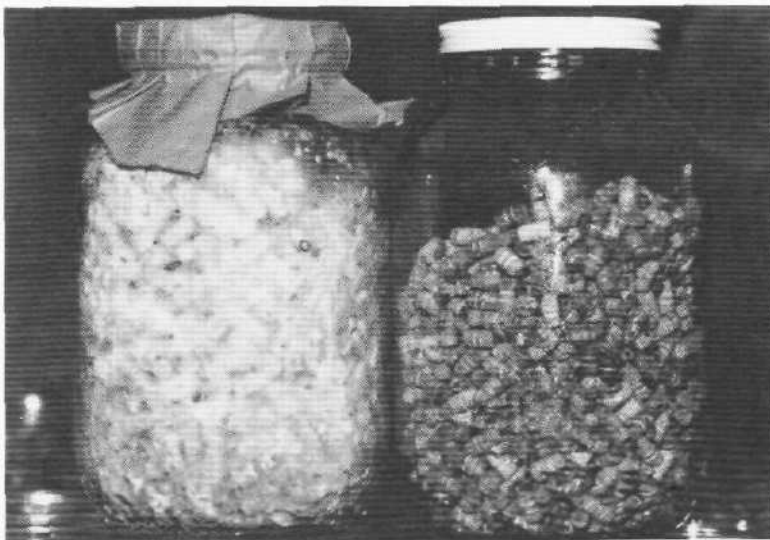

Figure 104 Oak dowels before and after colonization by shiitake (*Lentinus edodes*) mycelium.

Figure 105 Shiitake plug inserted into oak log.



Figure 106 Stacked arrangement of shiitake logs in a greenhouse.



Figure 107 Shiitake culture outdoors under shade cloth.





## SEMI-STERILE AND STERILE WOOD BASED SUBSTRATES

Mushrooms that grow on wood or wood wastes are termed lignicolous due to their ability to utilize lignin, a microbial resistant substance that constitutes the heart wood of trees. The main components of wood, however, are cellulose and hemicellulose, which are also nutrients available to lignin degrading mushroom mycelium. The chart appearing below shows a typical analysis of different wood and straw types. This table not only illustrates the similarities between wood and straw, but also the important differences between coniferous and broad leaf trees. The high concentrations of resins, turpentine and tanins make conifers less suitable for mushroom growing. Conifers are used on occasion, but they are mixed one to one with hardwood sawdust. In general, the wood of broad leaf or hardwood species have proven to be the best mushroom growing substrates. Specifically these tree types are: oak; elm; chestnut; beech; maple; and alder.

Type	Resin	N	P-2 0-5	K20	Hemi-cell.	Cell.	Lignin
Spruce ( <i>Picea excelsa</i> )	2.30	0.08	0.02	0.10	11.30	57.84	28.29
Pine ( <i>Pinus silvestris</i> )	3.45	0.06	0.02	0.09	11.02	54.25	26.25
Beech ( <i>Fagus silvatica</i> )	1.78	0.13	0.02	0.21	24.86	53.46	22.46
Birch ( <i>Betula verrucosa</i> )	1.80	—	—	—	27.07	45.30	19.56
Wheat Straw ( <i>Triticum sativum</i> )	0.00	0.60	0.30	1.10	—	36.15	16.15

Table of the analyses of various types of wood and straw. Figures are percent of dry weight. (Adapted from H. Rempe (1953)).

The most notable commercial species grown on wood is *Lentinus edodes*, the shiitake mushroom. Traditional methods use oak logs, 3-6 inches in diameter and three feet long, cut between fall and spring when the sap content is the highest. Special care should be taken not to injure the bark layer when cutting and handling the logs. The bark is of critical importance for fruiting and is one of the key factors considered by commercial growers when selecting tree species. The logs should be scraped clean of lichens and fungi and then drilled with four longitudinal rows of one inch deep holes spaced eight inches apart. Next, these holes are plugged with spawn and covered with wax. After 9 to 15 months of incubation the logs begin to fruit. (See the species parameter section in Chapter XI.) The use of freshly cut logs provides a semi-sterile substrate with no special treatment and is a very effective method for the home cultivator.

Commercial growers of lignicolous mushrooms are turning increasingly to sawdust based substrates. Such substrates have been developed in Japan for growing *Pleurotus*, *Flammulina* and

*Auricularia*. They are also being utilized with some modifications by commercial shiitake growers in the United States. The development of these mushroom specific substrates follows certain well defined guidelines.

The basic raw material is cellulose, a major constituent of sawdust, straw, cardboard or paper wastes, wood chips, or other natural plant fibers. Any of these materials should be chopped or shredded, but never so finely as to eliminate their inherent structural qualities. This cellulosic base comprises approximately 80% of the total substrate mixture.

To these basic substrate materials are added various nutrient supplements and growth stimulators in meal or flour form. By supplying proteins, carbohydrates, vitamins and minerals, the supplements serve to enhance the yield capabilities of the substrate base. Protein sources include concentrates like soya meal or soya flour, wheat germ and brewer's yeast. The most suitable carbohydrate sources are starchy materials such as rice, potatoes, corn and wheat. Some supplements are well balanced and provide both carbohydrates and proteins. Examples of these are bran, oatmeal and grains of all types. The number of possible supplements is extensive and need not be limited to those listed. The supplements comprise approximately 8-25% of the total dry weight. The addition of gypsum at a rate of 5% of the dry weight can improve the structure and porosity. It should be considered an optional ingredient.

Japanese growers of *Flammulina velutipes*, *Auricularia auricula* and allies, and *Pleurotus ostreatus* have a standard substrate formula consisting of 4 parts sawdust and 1 part bran, The saw-

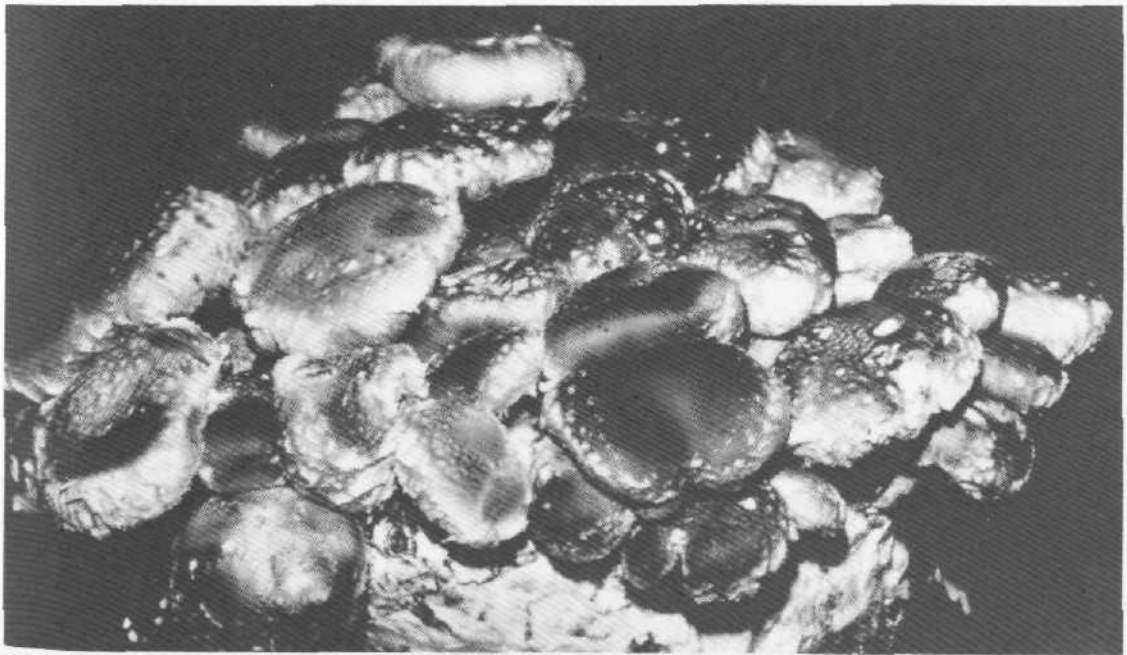
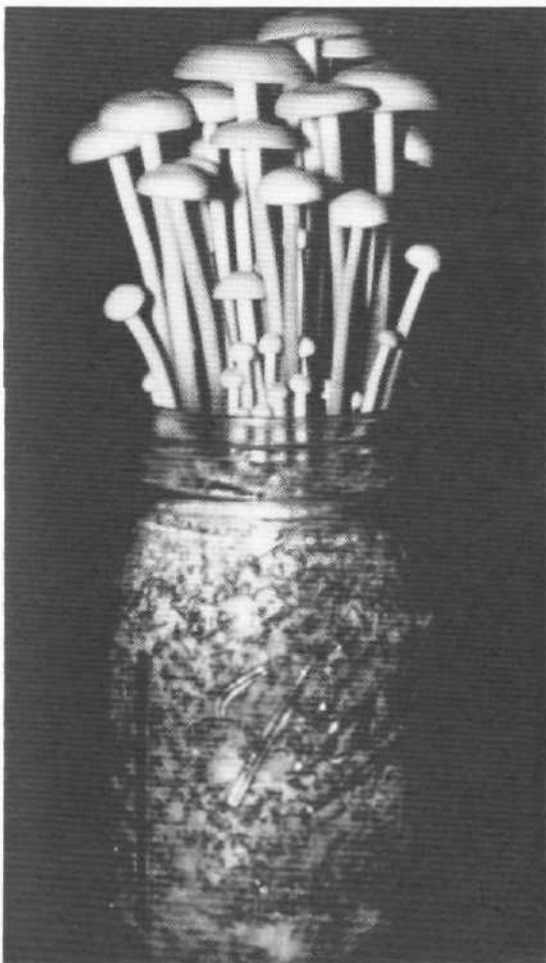

**Figure 108** Photograph of shiitake mushrooms growing on a sawdust block.

dust can be aged up to one year, which is said to improve its moisture holding capacity. Presoaking the sawdust prior to mixing in the bran is an effective way to achieve the required 60% moisture optimum. A firm squeeze of the mixture should produce only a few drops of water between the fingers. If the mixture has too much moisture, loose water collects in the bottom of the substrate container, a condition predisposing the culture to contamination.

The substrate can be filled into a number of different containers. Mason jars, polypropylene jars or high density, heat-resistant polyethylene bags are commonly employed. The containers are closed and sealed with a microporous filter. They are sterilized at 15 psi for 60-90 minutes. After sterilization the containers are cooled to ambient temperature and inoculated. The inoculum can be either grain spawn or sawdust-bran spawn.

During incubation substrate filled plastic bags can be molded to the desired cropping form. Common shapes are round mini-logs or rectangular blocks. Some *Pleurotus* growers mold the



**Figure 109** *Flammulina velutipes*, the Enoke Mushroom, fruiting in mason jar containing sawdust mixture.

**Figure 110** Autoclavable plastic bag and microporous filter disc, known in the Orient as the Space Bag.

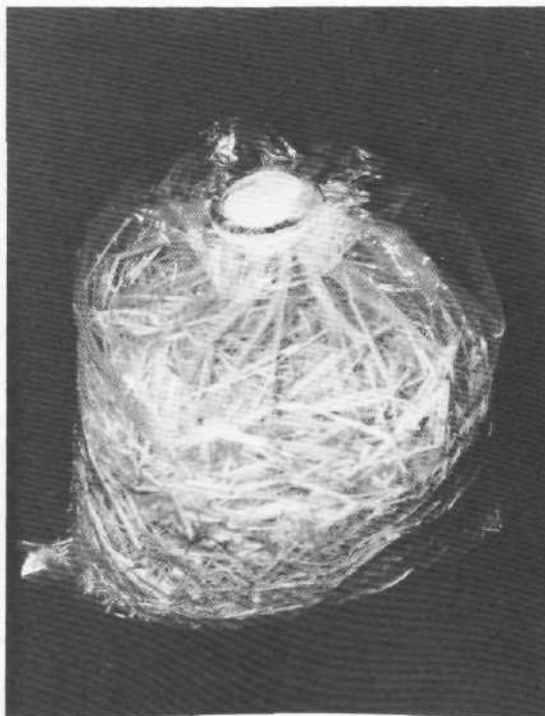

sawdust substrate into a cylindrical shape. 6-8 inches long and 4-5 inches in diameter. The fully colonized "logs" are stacked together on their sides with the ends exposed as the cropping surfaces. An alternative is to slit the bag lengthwise in four places, exposing the substrate to air while retaining the plastic as a humidity hood. If growing in jars, *Flammulina* and *Pleurotus* fruit from the exposed surface at the mouth of the jars.

## GROWING ON PASTEURIZED STRAW

In commercial mushroom production one of the most frequently used substrate materials is cereal straw. Not only does straw form the basis for mushroom composts, but it is also used uncomposted as the sole ingredient for the growth of various mushroom species. Although all types of straw are more or less suitable, most growers use wheat because of its coarse fiber and its availability. The straw should be clean, free from molds and unspoiled by any preliminary decomposition. Preparation simply involves chopping or shredding the dry straw into 1-3 inch pieces. This can be done with a wood chipper, a garden compost shredder or a power mower. The shredding increases moisture absorption by expanding the available surface area. Shredding also increases the density of the substrate mass.

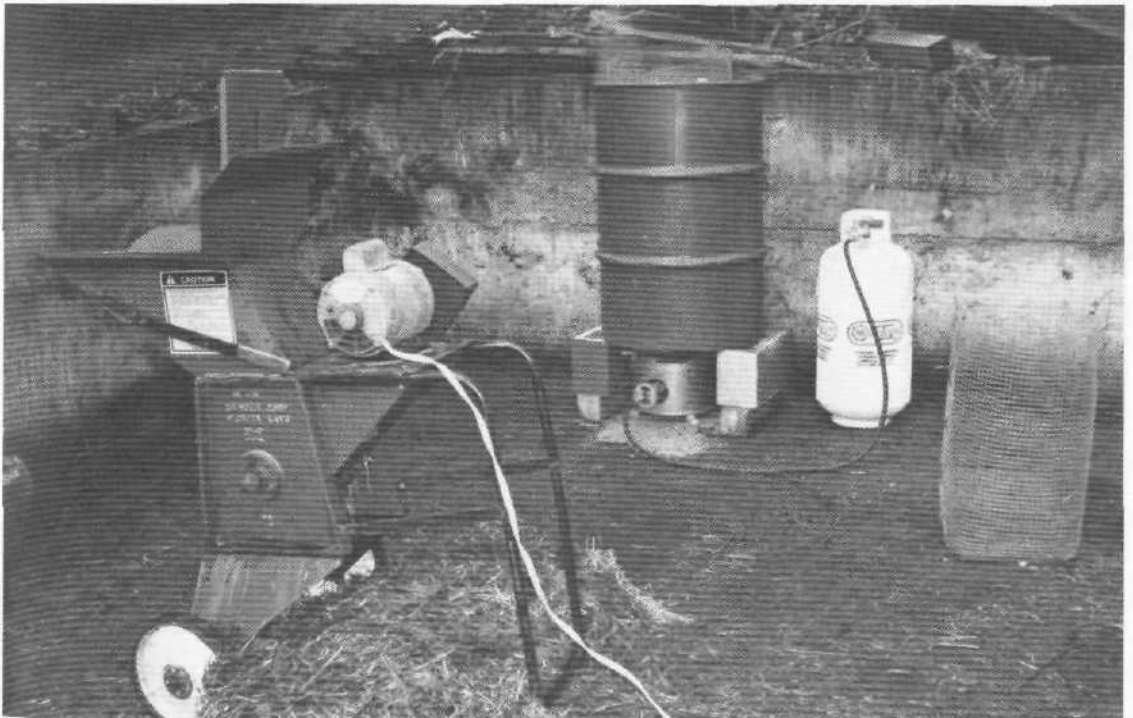

**Figure 111** Equipment needed for pasteurization of straw: 55 gallon drum; gas burner; shredder; hardware cloth basket and straw.

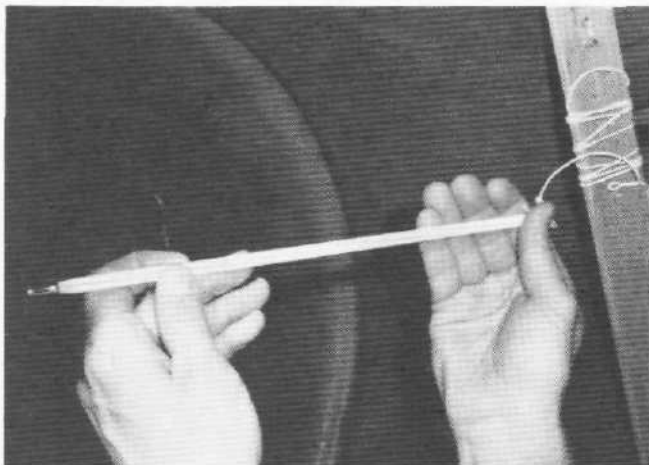

Figure 112 Shredding the straw.

Figure 113 Filling the shredded straw into the wire basket.

Figure 114 Checking the water temperature.

Figure 115 Draining the pasteurized straw.



The chopped straw is treated by pasteurization which can be carried out with live steam or hot water. Presoaked to approximately 75% water, the straw is filled into a tunnel or steam room as described in the composting chapter. It is steamed for 2-4 hours at 140-150°F., then cooled to 80°F. and spawned. An alternative program calls for 12-24 hours at 122°F. after the high temperature pasteurization. This program is designed to promote beneficial microbial growth giving the straw a higher degree of selectivity for mushroom mycelium.

The method best suited to the home cultivator is the hot water bath. Figure 111 illustrates a simple system utilizing a 55 gallon drum and a propane burner. The drum is half filled with water that is then heated to 160-170°F. Chopped dry straw is placed into the wire mesh basket and submerged in the hot water. (A weight is needed to keep the straw underwater.) After 30-45 minutes the straw is removed from the water and allowed to drain. It is very important to let all loose water run off.

Once drained, the straw is spread out on a clean surface and allowed to cool to 80 ° F. (or less), at which point it can be spawned. The straw is evenly mixed with spawn and filled into trays, shelves or plastic bags. Some compression of the straw into the container is desirable because the cropping efficiency will be increased.

The use of plastic bags is a simple and efficient way to handle straw substrates. A five gallon bag (1 -2 mils thick) is well suited to most situations. Two dozen nail sized holes equally spaced around the bags provide aeration. Upon full colonization, the mycelia of species like *Pleurotus ostreatus*

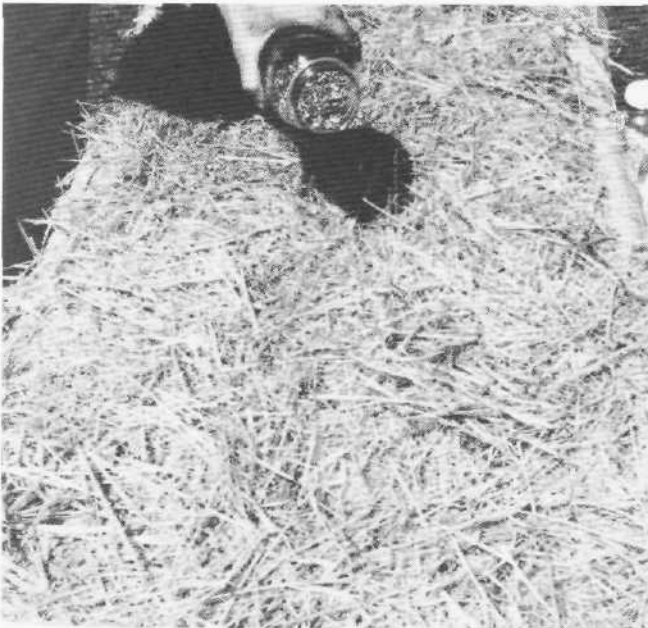

**Figure 116** Inoculating grain spawn onto the cooled pasteurized straw.

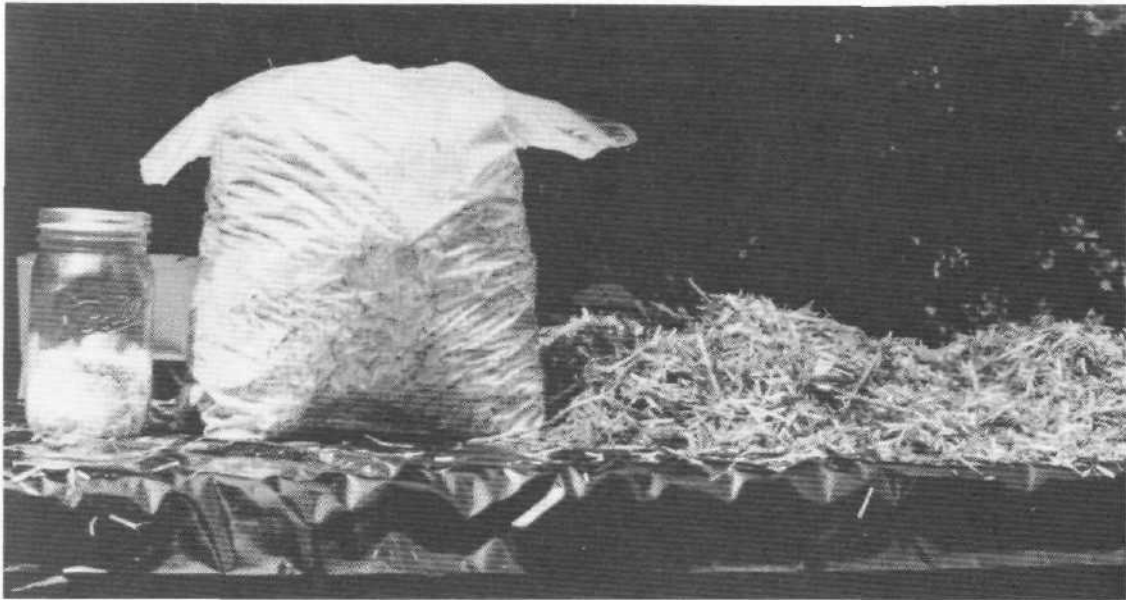

**Figure 117** Pasteurized straw stuffed into plastic bags which are then perforated with nail size holes.

and *Psilocybe cubensis* actually hold the straw together, at which time the bag can be completely removed. Another alternative is to perforate or strip the bag from the top or side to allow easy cropping.

Wheat straw prepared and pasteurized in this manner can be used to grow *Pleurotus ostreatus*, *Stropharia rugoso-annulata*, *Panaeolus cyanescens* and *Psilocybe cubensis*. It is quite possible that other species can utilize this substrate or a modification of it. Studies with *Pleurotus ostreatus* have demonstrated yield increases with the addition of 20% grass meal prior to substrate pasteurization. Supplementation of the straw after a full spawn run is another method of boosting yields (See Chapter VII.) Bono (1978) obtained a yield increase of 85% with *Pleurotus flabellatus* by adding cottonseed meal to the fully colonized straw. The optimum rate of addition was 132 grams per kilogram of dry straw (approximately 22 grams crude protein per kilogram straw). Bono also found that supplementation increased the protein content and intensified the flavor of the mushrooms.

# CHAPTER VII

## SPAWNING AND SPAWN

### RUNNING IN BULK SUBSTRATES



Figure 118 Mycelium running through compost.



The inoculation of compost or bulk substrates is called **spawning**. The colonization of these substrates by the mushroom mycelium is known as **spawn running**. At spawning and during spawn running there are several factors that must be considered if yields are to be maximized. These factors are:

1. Moisture content of the substrate.
2. Temperature of the substrate.
3. Dry weight of the substrate per square foot of cropping surface.
4. Duration of spawn running.

## Moisture Content

Mushroom mycelium does not grow in a substrate that is either too dry or too wet. A dry substrate produces a fine wispy mycelial growth and poor mushroom formation because the water essential for the transport and assimilation of nutrients is lacking. On the other hand, an over-wet substrate inhibits mycelial growth and produces overly stringy mycelia. Controlled experiments with *Agaricus brunnescens* grown on horse manure composts have shown yield depressions when the moisture content deviates more than 2% from the optimum. Deviations greater than 5% generally result in a spawn run that does not support fruitbody production. A dry compost at spawning should be lightly watered and mixed well to guard against the formation of wet spots. For an over-wet compost the common procedure is to add gypsum until the loose water is bound.

## Substrate Temperature

Since mushroom mycelium grows within the substrate, the substrate temperature must be monitored closely. Thermometers are placed both in the center of the substrate—the hottest region—and in the room's atmosphere. These two thermometers establish a temperature differential. If the hottest point in the substrate is 80 ° F. and the air is 70 ° F. then the temperature of the total mass must lie within this range.

The optimum temperature for mycelial growth varies depending on the mushroom species. *Agaricus brunnescens* grows fastest at 77 °F. whereas *Psilocybe cubensis* prefers 86 °F. Temperatures higher or lower simply slow mycelial growth. The growth curve shown in Figure 119 illustrates the effect of temperature on the growth of *Agaricus brunnescens* mycelium. Note that growth slows at a faster rate as the temperature rises above the optimum. Therefore the object during spawn running is to keep the substrate within the temperature range that is optimal for the fastest growth of mycelium.

## Dry Weight of Substrate

Other factors aside, the dry weight of substrate per square foot of cropping surface largely determines total yield. Commercial *Agaricus* growers aim for at least five pounds of dry weight of compost per square foot and sometimes compress up to eight pounds per sq. ft. into their containers. Cropping efficiencies are calculated by dividing total yield per square foot into the dry weight of one

---

square foot of the substrate. Thus a yield of four pounds per sq. ft. of freshly picked mushrooms divided by five pounds dry weight of substrate equals an 80% cropping efficiency. Efficiencies of 80-100% are considered to be close to the maximum yield potential of *Agaricus brunnescens*.

The actual amount of substrate that can be compacted into one square foot of growing area and managed depends upon the cooling capabilities of the control system as well as the outside temperature. Experiments using Tracer elements in mushroom beds three feet deep have shown that nutrients from the farthest point are transported to the growing mushrooms. Yields per sq. ft. increased although at a lower substrate efficiency.

During spawn running the metabolism of the growing mycelium generates tremendous quantities of heat. Substrate temperatures normally reach a peak on the 7th-9th days after spawning and can easily reach 90 °F. At this temperature thermophilic microorganisms become active, thereby increasing the possibilities of further heat generation. The substrate can easily soar above 100 °F. and a compost can actually rise again to conditioning temperatures. Temperatures between 95-110 °F. can kill the mycelium of many mushrooms. Even if the mycelium is not completely killed, these temperatures do irreversible harm to mycelial vitality and fruiting potential. These elevated temperatures also stimulate the activity of competitor molds and may render the substrate unsuitable for further mushroom growth. Because of the enhanced heat generating capabilities of deeply filled beds, *Agaricus* growers rarely fill more than 12 inches of compost into the beds.

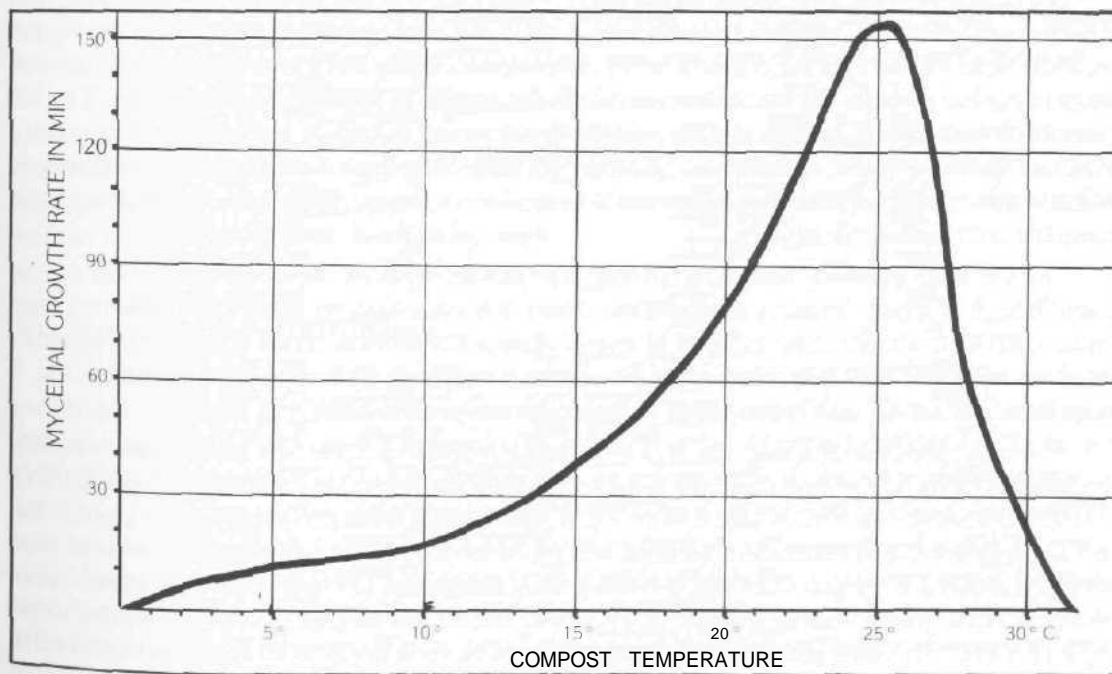

Figure 119 Growth curve of *Agaricus brunnescens* on compost.

The decision on how deep to fill the spawned substrate is an important one. Here again, the ratio of substrate to free air space in the growing room is significant. (See Chapter IV). An efficient method of spawn running is to fill trays 6-8 inches deep with compost and stack them closely together in the room. In this manner the heat generated within each tray remains controllable, while at the same time the total compost heat will be sufficient to heat the room. Outside air temperature as well as the capacity of the heating and cooling equipment should determine how many substrate filled containers can be placed within a given space. Fresh air is generally used to provide cooling except when it is warmer than the room temperature.

## Duration of Spawn Run

Once colonization is complete, the substrate should be cased, or if casing is not used, it should be switched to a fruiting mode. If spawn running is continued beyond this point, valuable nutrients that could be utilized for production of fruitbodies will be consumed by further vegetative growth. If for some reason the cropping cycle must be delayed, the substrate should be cooled until a more opportune time.

## Spawning Methods

Spawning methods, like spawn itself, have evolved over the years. As late as 1950 *Agaricus brunnescens* growers customarily planted walnut sized pieces of manure spawn or kernels of grain spawn in holes poked into the compost at regular intervals. Using this method spawn running was slow, and areas far from the inoculum were more susceptible to invasion by competitors. The full potential of grain spawn was not realized until the development of "mixed spawning". The principle of mixed spawning is the complete and thorough mixing of the grain kernels throughout the substrate. In this manner all parts of the substrate are equally inoculated, resulting in the most rapid and complete colonization possible.

The standard spawning rate used by *Agaricus* growers is seven liters/ton of compost or one quart/8 sq. ft. If spawn is readily available and cheap, it is advantageous to use high spawning rates which lead to more rapid colonization. It is also advantageous to break up the grain spawn into individual kernels the day before spawning. If the spawn is fresh, the grain should break apart easily. If the spawn can not be used when fresh, it should be refrigerated at 38°F.

The basic principle of spawn running is the same regardless of the type of mushroom or substrate. COLONIZATION MUST PROCEED AS RAPIDLY AS POSSIBLE TO PREVENT OTHER ORGANISMS FROM BECOMING ESTABLISHED. Once the mushroom mycelium becomes dominant, natural antibiotics secreted into the substrate inhibit competitors. To prevent invasion by competitors it is important that spawning take place under carefully controlled hygienic conditions. Fungus gnats in particular must be excluded, and for this purpose a tight, well sealed working area is best. This area and all tools should be disinfected one day prior to spawning with a 10% bleach solution. When using disinfectants be sure your skin is protected and avoid breathing any fumes.

---



**Figure 120** *Psilocybe semilanceata* mycelium running through pasteurized wheat straw.

If the substrate has been filled into shelves, the spawn is broadcast over the surface and mixed in with a pitchfork or by hand. With trays, a similar method can be used, or alternatively, the substrate can be dumped out on a clean surface, mixed with spawn and then replaced in the trays. Substrates from a bulk room are removed, mixed with spawn and then placed into the chosen container.

It is common procedure to level and compress the substrate to avoid dehydration caused by excessive air penetration. The degree of compression depends upon substrate structure. Long, airy materials can be compacted more than short, dense ones. Commercial tray growers compact the compost into the trays with a hydraulic press so that the compost surface resembles a table top. This enables the application of an even casing layer.

## Environmental Conditions

The required environmental conditions for spawn running are very specific and must be closely monitored. Substrate temperatures are controlled by careful manipulation of the surrounding air temperature. Heating and cooling equipment are helpful but not absolutely essential unless the outside climate is extreme. A well insulated room with provisions for fresh air entrance and exhaust air exit should be adequate for most situations. The steady or periodic recirculation of room air by means of a small fan helps to keep an even temperature throughout the room and guards against localized over-heating, especially in the uppermost containers. Humidity is extremely important at this time and must be held at 90-100%. If the humidity falls below this level, water evaporates from the substrate surface to the detriment of the growing mycelium. Humidification can be accomplished by steam humidifiers or by cold water misters. If steam is used, care must be taken that the increase in air temperature does not drive the substrate temperature above the optimal range. One common

method of counteracting drying is to cover the substrate with plastic. Be ready to remove the covering during the period of peak activity if temperatures rise too quickly.

During spawn run the mushroom mycelium generates large quantities of carbon dioxide. In fact, it has been demonstrated that mushroom mycelium is capable of CO<sub>2</sub> fixation. Because of this ability to absorb CO<sub>2</sub>, room concentrations of 10,000-15,000 ppm are considered beneficial and desirable. A CO<sub>2</sub> level high enough to stop growth is uncommon under normal circumstances. Being heavier than air, CO<sub>2</sub> settles at the bottom of the room, which is yet another reason for even air circulation within the growing environment.

## Super Spawning

Super spawning is also called "active mycelium spawning" vis a vis the Hunke-Till process. Essentially, a set amount of substrate is inoculated and colonized in the normal manner. The fully run substrate is then used as inoculum to spawn increased amounts of a similar substrate. One could theoretically pyramid a small quantity of inoculum into a considerable amount of fully colonized substrate. This technique requires the primary substrate to be contaminant free; otherwise contamination, not mycelium, will be propagated. The possibilities inherent in this method may be of greater application when transferring naturally occurring mycelial colonies to non-sterile yet mushroom specific substrates. An excellent example of this is the propagation of *Psilocybe cyanescens* on wood chips. (See Chapter VI.)

## Supplementation at Spawning

One of the newest advances in *Agaricus* culture is the development of delayed release nutrients added to the compost at spawning. These supplements are specially formulated nutrients encapsulated in a denatured protein coat. They are designed to become available to the growing mushrooms during the first three flushes. The application rate is 5-7% of the dry weight of the substrate. Yield increases of ½ to 1 lb/sq. ft. are normal. Here again, complete and thorough mixing is essential to success. Caution: these materials enrich the substrate, making it more suitable to contaminants if factors predisposing to their growth are present. (For suppliers of delayed release nutrients, refer to the resource section in the Appendix).

## Supplementation at Casing (S.A.C.)

SACing is another method used to boost the nutritional content of the substrate. The materials used are soy bean meal, cottonseed meal, and/or ground rye, wheat or kafir corn grains. The fully colonized substrate is thoroughly mixed with any one of these materials at a rate of 10% of the dry weight of the substrate. The substrate and the supplements must both be clean and free from contaminants; otherwise contamination will spread and threaten the entire culture. High substrate temperatures should be anticipated on the second to third day after supplementation. With this type of nutrient enhancement yield increases of ½-2 lbs/sq. ft. are possible.

---

## CHAPTER VIII THE CASING LAYER



Figure 121 *Panaeolus cyanescens* fruiting in tray of pasteurized straw. Note mushrooms formed only on cased half.

Covering the substrate surface with a layer of moist material having specific structural characteristics is called casing. This practice was developed by *Agaricus* growers who found that mushroom formation was stimulated by covering their compost with such a layer. A casing layer encourages fruiting and enhances yield potential in many, but not all, cultivated mushrooms.

SPECIES	CASING OPTIONAL	CASING REQUIRED	CASING NOT REQUIRED
<i>Ag. brunnescens</i>		•	
<i>Ag. bitorquis</i>		•	
<i>C. com at us</i>	•		
<i>Fl. velutipes</i>			•
<i>Lentinus edodes</i>			•
<i>Lepista nuda</i>	•		
<i>Pl. ostreatus</i>			•
<i>Pl. ostreatus</i> (Florida variety)			•
<i>Pan. cyanescens</i>		•	
<i>Pan. subbalteatus</i>	•		
<i>Ps. cubensis</i>	•		
<i>Ps. cyanescens</i>			•
<i>Ps. mexicana</i>		•	
<i>Ps. tampanensis</i>		•	
<i>S. rugoso-annulata</i>		•	
<i>V. volvacea</i>			•

In all species where the use of a casing has been indicated as optional, yields are clearly enhanced with the application of one. The chart above refers to the practical cultivation of mushrooms in quantity. It excludes fruitings on nutrified agar media or on other substrates that produce but a few mushrooms. Consequently, casing has become an integral part of the mushroom growing methodology.

## Functions

The basic functions of the casing layer are:

### 1. To protect the colonized substrate from drying out.

Mushroom mycelium is extremely sensitive to dry air. Although a fully colonized substrate is primarily protected from dehydration by its container (the tray, jar or plastic bag), the cropping surface remains exposed. Should the exposed surface dry out, the mycelium dies and forms a hardened mat of cells. By covering the surface with a moist casing layer, the mycelium is protected from the damaging effects of drying. Moisture loss from the substrate is also reduced.

- 2. To provide a humid microclimate for primordia formation and development.**

The casing is a layer of material in which the mushroom mycelium can develop an extensive, healthy network. The mycelium within the casing zone becomes a platform that supports formation of primordia and their consequent growth into mushrooms. It is the moist humid microclimate in the casing that sustains and nurtures mycelial growth and primordia formation.
- 3. To provide a water reservoir for the maturing mushrooms.**

The enlargement of a pinhead into a fully mature mushroom is strongly influenced by available water, without which a mushroom remains small and stunted. With the casing layer functioning as a water reservoir, mushrooms can reach full size. This is particularly important for heavy flushes when mushrooms are competing for water reserves.
- 4. To support the growth of fructification enhancing microorganisms.**

Many ecological factors influence the formation of mushroom primordia. One of these factors is the action of select groups of microorganisms present in the casing. A casing prepared with the correct materials and managed according to the guidelines outlined in this chapter supports the growth of beneficial microflora.

## Properties

The casing layer must maintain mycelial growth, stimulate fruiting and support continual flushes of mushrooms. In preparing the casing, the materials must be carefully chosen according to their chemical and physical properties. These properties are:

- 1. Water Retention:** The casing must have the capacity to both absorb and release substantial quantities of water. Not only does the casing sustain vegetative growth, but it also must supply sufficient moisture for successive generations of fruitbodies.
- 2. Structure:** The structure of the casing surface must be porous and open, and remain so despite repeated waterings. Within this porous surface are small moist cavities that protect developing primordia and allow metabolic gases to diffuse from the substrate into the air. If this surface microclimate becomes closed, gases build up and inhibit primordia formation. A closed surface also reduces the structural cavities in which primordia form. For these reasons, the retention of surface structure directly affects a casing's capability to form primordia and sustain fruitbody production.
- 3. Microflora:** Recent studies have demonstrated the importance of beneficial bacteria in the casing layer. High levels of bacteria such as *Pseudomonas putida* result in increased primordia formation, earlier cropping and higher yields. During the casing colonization period these beneficial bacteria are stimulated by metabolic gases that build up in the substrate and diffuse through the casing. In fact, dense casing layers and deep casing layers generally yield more mushrooms because they slow diffusion. It is desirable therefore to build-up CO<sub>2</sub> and other gases prior to primordia formation. (For a further discussion on the influence of bacteria on primordia formation, see Appendix II.)

The selection of specific microbial groups by mycelial metabolites is an excellent ex-



ample of symbiosis. These same bacteria give the casing a natural resistance to competitors. In this respect, a sterilized casing lacks beneficial microorganisms and has little resistance to contaminants.

4. **Nutritive Value:** The casing is not designed to provide nutrients to developing mushrooms and should have low nutritional value compared to the substrate. A nutritive casing supports a broader range of competitor molds. Wood fragments and other undecomposed plant matter are prime sites for mold growth and should be carefully screened out of a well formulated casing.
5. **pH:** The pH of the casing must be within certain limits for strong mycelial growth. An overly acidic or alkaline casing mixture depresses mycelial growth and supports competitors. *Agaricus brunnescens* prefers a casing with pH values between 7.0-7.5. Even though the casing has a pH of 7.5 when first applied, it gradually falls to a pH of nearly 6.0 by the end of cropping due to acids secreted by the mushroom mycelium. Buffering the casing with limestone flour is an effective means to counter this gradual acidification. The optimum pH range varies according to the species. (See the growing parameters for each species in Chapter XI.)
6. **Hygienic Quality:** The casing must be free of pests, pathogens and extraneous debris. Of particular importance, the casing must not harbor nematodes or insect larvae.

## Materials

To better understand how a casing layer functions requires a basic understanding of soil components and their specific structural and textural characteristics. When combined properly, the soil components create a casing layer that is both water retentive and porous.

1. **Sand:** Characterized by large individual particles with large air spaces in between, sandy soils are well aerated. Their structure is considered "open". Sandy soils are heavy, hold little water and release it quickly.
2. **Clay:** Having minute individual particles bound together in aggregations, clay soils have few air pockets and are structurally "closed". Water is more easily bound by clay soils.
3. **Loam:** Loam is a loose soil composed of varying proportions of sand and clay, and is characterized by a high humus content.

*Agaricus* growers found that the best type of soil for mushroom growing was a clay/loam. The humus and sand in a clay/loam soil open up the clay which is typically dense and closed. The casing's structure is improved while the property of particle aggregation is retained. The humus/clay combination holds moisture well and forms a crumbly, well aerated casing.

There are two basic problems with using soils for casing—the increased contamination risk from fungi and nematodes, and the loss of structure after repeated waterings. Cultivators can reduce the risk of contamination by pasteurization, a process whereby the moistened casing soil is thoroughly and evenly steamed for two hours at 160° F. An alternative method is to bake the moist soil in an oven for two hours at 160° F.

---



**Figure 122 Sphagnum peat and limestone flour needed for casing.**

The development of casings based on peat moss has practically eliminated the use of soil in mushroom culture. Peat is highly decomposed plant matter and has a pH in the 3.5-4.5 range. Since this acidic condition precludes many contaminants from colonizing it as a substrate, peat is considered to be a fairly "clean" starting material. Peat based casings rarely require pasteurization. But because peat is too acidic for most mushrooms, the addition of some form of calcium buffering agent like limestone is essential. "Liming" also causes the aggregation of the peat particles, giving peat a structure similar to a clay/loam soil. A coarse fibrous peat is preferred because it holds its structure better than a fine peat. In essence, the properties of sphagnum peat conform to all the guidelines of a good casing layer.

Buffering agents are used to counter the acidic effects of peat and other casing materials. Calcium carbonate ( $\text{CaCO}_3$ ) is most commonly used and comes in different forms, some more desirable than others.

1. **Chalk:** Used extensively in Europe, chalk is soft in texture and holds water well. Chunks of chalk, ranging from one inch thick to dust, improve casing structure and continuously leach into the casing, giving long lasting buffering action.
2. **Limestone Flour:** Limestone flour is calcitic limestone mined from rock quarries and ground to a fine powder. It is the buffering agent most widely used by *Agaricus* growers in the United States. Limestone flour is 97%  $\text{CaCO}_3$  with less than 2% magnesium.

3. **Limestone Grit:** Produced in a fashion similar to limestone flour, limestone grit is rated according to *particle size* after being screened through varying meshes. Limestone grit is an excellent structural additive but has low buffering abilities. A number 9 *grit* is recommended.
4. **Dolomitic Limestone:** This limestone is rarely used by *Agaricus* growers due to its high magnesium content. Some researchers have reported depressed mycelial growth in casings high in magnesium.
5. **Marl:** Dredged from dry lake bottoms, marl is a *soft lime* similar to chalk but has the consistency of clay. It is a composite of clay and calcium carbonate *with* good water holding capacity.
6. **Oyster Shell:** Comprised of calcium carbonate, ground up oyster shell is similar to limestone grit in its buffering action and its structural contribution to the casing layer. But *oyster shell* should not be used as the sole buffering agent because of its low solubility in *water*.

### Table Comparing Casing Soil Components

Material	Absorption Potential milliliters water/gram	% Water at Saturation
Vermiculite	5.0	84%
Peat	2.5	79%
Potting Soil	0.7	76%
Loam	0.3	25%
Chalk	0.6	37%
Limestone Grit	0.2	15%
Sand	0.2	18%

Values vary according to source and *quality* of material used. Tests run by the authors.)

### Casing Formulas and Preparation

The following casing formulas are widely used in *Agaricus* culture. With pH adjustments they can be used with most mushroom species that require a casing. Measurement of materials is by volume.

#### FORMULA 1

Coarse peat: 4 parts  
 Limestone flour: 1 part  
 Limestone grit: 1/2 part  
 Water: Approximately 2-2 1/4 parts

#### FORMULA 2

Coarse peat: 2 parts  
 Chalk or Marl: 1 part  
 Water: Approximately 1-1 1/4 parts

One half to one part coarse vermiculite can be added to improve the water retaining *capacity* of these casing mixtures and can be an aid if fruiting on thinly laid substrates. When used, it must

be presoaked to saturation before being mixed with the other listed ingredients.

An important reference point for cultivators is the moisture saturation level of the casing. To determine this level, completely saturate a sample of the casing and allow it to drain. Cover and wait for one half hour. Now weigh out 100 grams of it and dry in an oven at 200 °F. for two to three hours or until dry. Reweigh the sample and the difference in weight is the percent moisture at saturation. This percentage can be used to compare moisture levels at any point in the cropping cycle. Optimum moisture content is normally 2-4% below saturation. Typically, peat based casings are balanced to a 70-75% moisture content.

## Application

To prepare a casing, assemble and mix the components while in a dry or semi-dry state. Even distribution of the limestone buffer is important with a thoroughly homogeneous mixture being the goal. When these materials have been sufficiently mixed, add water slowly and evenly, bringing the moisture content up to 90% of its saturation level. There is an easy method for preparing a casing of proper moisture content. Remove 10-20% of the volume of the dry mix and then saturate the remaining 80-90%. Then add the remaining dry material. This method brings the moisture content to the near optimum. (Some growers prefer to let the casing sit for 24 hours and fully absorb water. Prior to its application, the casing is then thoroughly mixed again for even moisture distribution).

At this point apply the casing to the fully run substrate. Use a pre-measured container to consistently add the same volume to each cropping unit.

1. **Depth:** The correct depth to apply the casing layer is directly related to the depth of the substrate. Greater amounts of substrate increase yield potential which in turn puts more stress on the casing layer. Prolific first and second flushes can remove a thin casing or damage its surface structure, thereby limiting future mushroom production. A thin casing layer also lacks the body and moisture holding capacity to support large flushes. AS A GENERAL RULE, THE MORE MUSHROOMS EXPECTED PER SQUARE FOOT OF SURFACE AREA, THE DEEPER THE CASING LAYER.

*Agaricus* growers use a minimum of one inch and a maximum of two inches of casing on their beds. Substrate depths of six to eight inches are cased 1 1/4 to 1 1/2 inches deep. Substrates deeper than 8 inches are cased 1 1/2 to 2 inches deep. Nevertheless, experiments in Holland using casing depths of 1 inch and 2 inches demonstrated that the deep casing layer supported higher levels of microorganisms and produced more mushrooms. (See Visscher, 1 975). To gain the full benefits of a casing layer, an absolute minimum depth on bulk substrates is 1 inch. For fruiting on sterilized grain, the casing need not be as deep as for fruitings on bulk substrates. Shallow layers of grain are commonly cased 3/4 to 1 inch deep.

2. **Evenness:** The casing layer should be applied as evenly as possible on a level substrate surface. An uneven casing depth is undesirable for two reasons: shallower regions can



Figures 123, 124 & 125 Casing a tray of grain spawn. First the fully colonized grain is carefully broken up and evenly distributed into the tray. As an option, a layer of partially moistened vermiculite can be placed along the bottom of the tray to absorb excess water. If the grain appears to have uncolonized kernels, cover the container with plastic and let the spawn recover for 24 hours before casing. Otherwise, casing can proceed immediately after the spawn has been laid out.

easily be overwatered, thereby stifling mycelial growth; and secondly, the mycelium breaks through the surface at different times, resulting in irregular pinhead formation. When applying the casing to large areas, "depth rings" can be an effective means to insure evenness. These rings are fabricated out of flat metal or six inch PVC pipe, cut to any depth. They are placed on the substrate and covered with the casing, which is then leveled using the rings as a guide. Once the casing is level and even, the rings are removed.

Although the casing layer must be even, the surface of The casing should remain rough and porous, with small "mountains and valleys". The surface structure is a key to optimum pinhead formation and will be discussed in more detail in the next chapter.

## Casing Colonization

Environmental conditions after casing should be the same as during spawn running. Substrate temperatures are maintained within the optimum range for mycelial growth; relative humidity is 90-100%; and fresh air is kept to a minimum. (Fresh air should only be introduced to offset overheating). The build-up of  $\text{CO}_2$  in the room is beneficial to mycelial growth and is controlled by an airtight room and tightly sealed fresh air damper. If the entrance of fresh air cannot be controlled, a

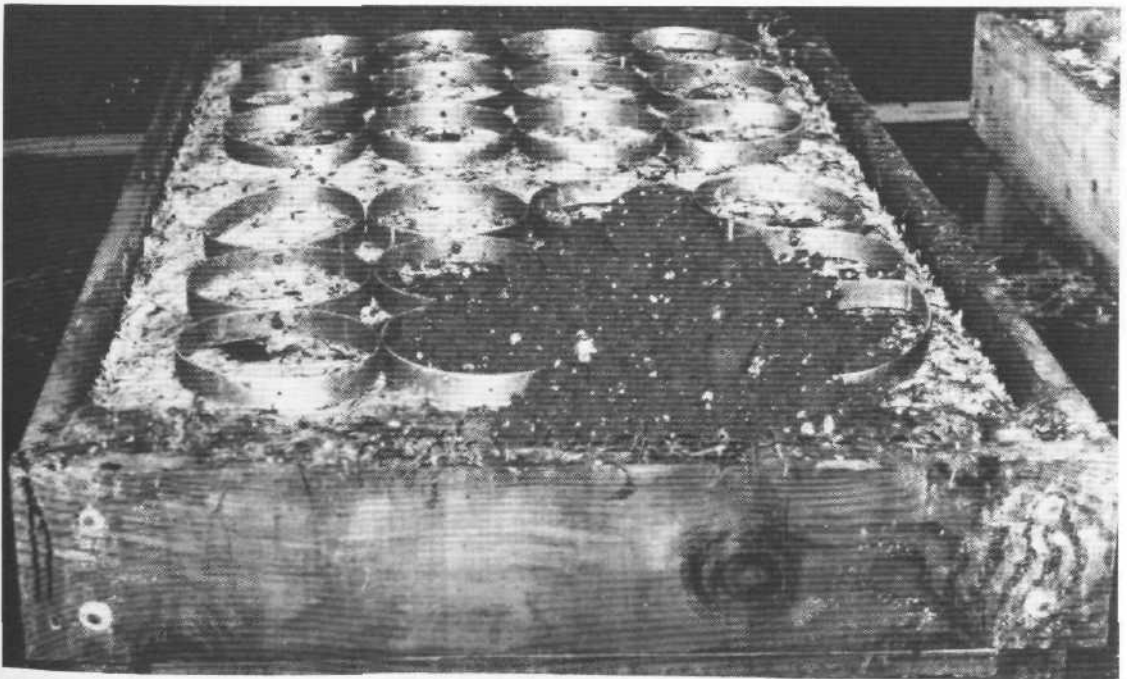

Figure 126 Depth rings used for even casing application on bulk substrates.



**Figure 127 Mycelial growth (*Agaricus brunnescens*) into casing with optimum moisture.**

sheet of plastic should be placed over the casing. This plastic sheet also prevents moisture loss from the casing.

Soon after casing, substrate *temperatures* surge upward due to the hampered diffusion of metabolic gases which would normally conduct heat away. This surge is an indication of mycelial vitality and is a positive sign if the room temperature can be controlled. This temperature rise can be anticipated by lowering either the temperature of the substrate prior to casing or lowering The air temperature of the room after casing.

Within three days of application, the mycelium should be growing into the casing layer. Once mycelial growth is firmly established, the casing is gradually watered up to its optimum moisture holding capacity. This is accomplished by a series of light waterings with a misting nozzle over a two to four day period (depending upon the depth of the casing). Deeper casings require more waterings. Optimum moisture capacity should be achieved at least two days before the mycelium reaches the surface. **IT IS EXTREMELY IMPORTANT THAT THE WATERINGS DO NOT DAMAGE THE SURFACE STRUCTURE OF THE CASING.** Heavy direct watering can “pan” the casing surface, closing all the pore spaces and effectively sealing it. The growing mycelium is then trapped within the casing layer and may not break through it at all. The ultimate example of panning is a soil turned to mud.

To repair a casing surface damaged by watering, the top 14 inch can be reopened by a technique called "scratching". The tool used is simply a 1 x 2 x 24 inch board with parallel rows of

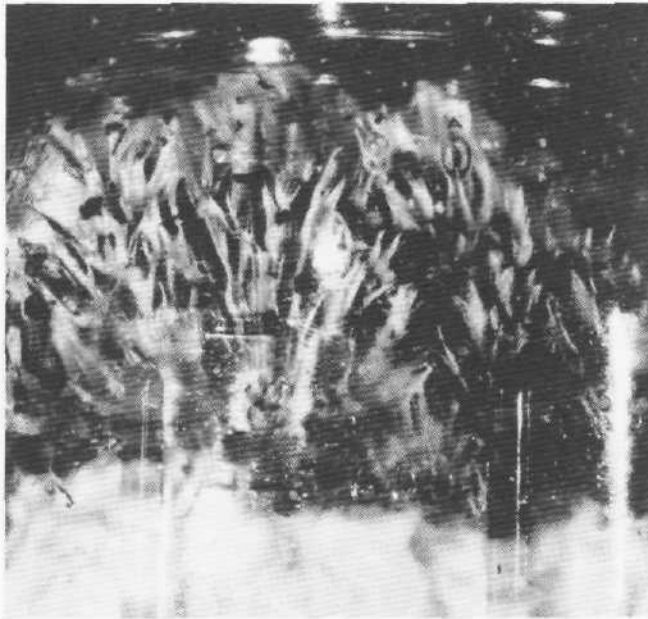

**Figure 128** Mycelial growth (*Psilocybe cubensis*) into casing with optimum moisture.

nails (6 penny) slightly offset relative to one another. With this "scratching stick", the casing is lightly ruffled prior to the mycelium breaking through to the surface. After the surface has been scratched, the casing should be given its final waterings prior to pinning.

A modified application of this technique is "deep scratching". When the mycelium is midway through the casing, the entire layer is thoroughly ruffled down to the bulk substrate. The agitated and broken mycelium rapidly reestablishes itself and within three to four days it completely colonizes the casing. The result is an early, even and prolific pinhead formation. Before using this technique, the grower must be certain that the substrate and casing are free of competitor molds and nematodes.

## Casing Moisture and Mycelial Appearance

Moisture within the casing layer has a direct effect on the diameter and degree of branching in growing mycelium. These characteristics are indicators of moisture content and can be used as a guide to proper watering.

- I- **Optimum Casing Moisture:** Mushroom mycelium thrives in a moist humid casing, sending out minute branching networks. These networks expand and grow, absorbing water,  $\text{CO}_2$  and oxygen from the near saturated casing. This mycelial growth is characterized by many thick, white rhizomorphic strands that branch into mycelia of smaller diameters and correspondingly smaller, finer capillaries. The overall aspect is lush and



dense. When a section of casing is examined, it is held firmly together by the mycelial network but will separate with little effort. The casing itself remains soft and pliable.

2. **Overly dry casing:** In a dry casing, the mycelium is characterized by a lack of rhizomorphs and an abundance of fine capillary type mycelia. This fine growth can totally permeate the casing layer, which then becomes hard, compact and unreceptive to water. It is common for puddles to form on a dry casing that has just been watered. Also, a dry casing rarely permits primordia formation because of its arid microclimate and is susceptible to "overlay". Mushrooms, if they occur, frequently form along the edges of the tray.

Overlay is a dense mycelial growth that covers the casing surface and shows little or no inclination to form pinheads. Overlay directly results from a dry casing, high levels of CO<sub>2</sub> and/or low humidity. (See Chapter IX on pinhead initiation).

3. **Overly Wet Casing:** In a saturated casing, the mycelium grows coarse and stringy, with very little branching and few capillaries. Mycelial growth is slow and sparse which leaves the casing largely uncolonized. Often the saturated casing leaches onto the substrate surface which then becomes waterlogged, inhibiting further growth and promoting contamination. Subsequent drying may eventually reactivate the mycelium, but a reduction in yield is to be expected.

# CHAPTER IX STRATEGIES FOR MUSHROOM FORMATION (PINHEAD INITIATION)

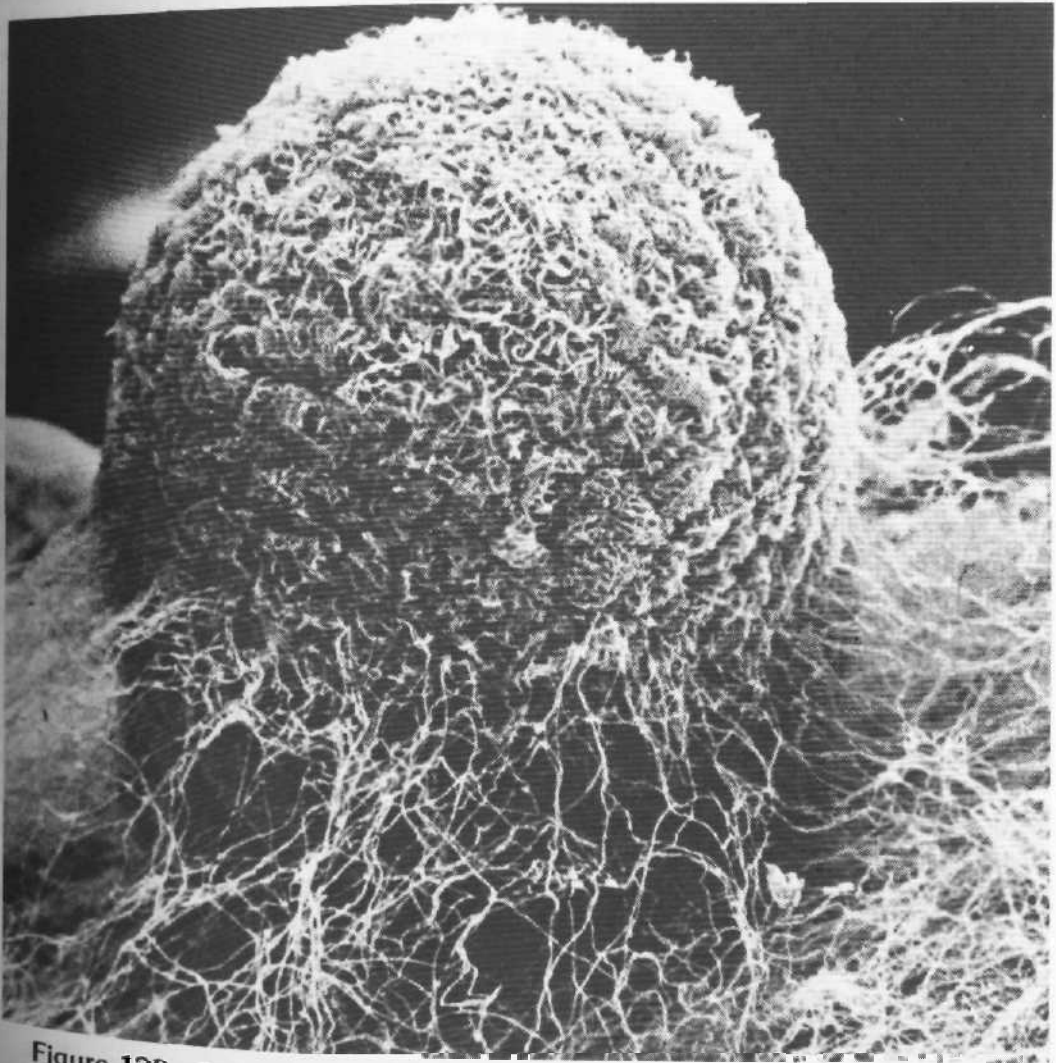

Figure 120 Scanning electron micrograph of *Psilocybe cubensis* primordia.

The change from the vegetative state of mycelial growth to the generative one of primordia formation is called pinning, pin setting, pinhead initiation or fructification. Primordia or pinheads are knots of mycelium that precede development into small mushrooms. All species require a set of environmental conditions for pinning that are quite different from the conditions for mycelial growth. By understanding the factors that regulate this change in the mushroom life cycle, the cultivator can control the pinning process.

In nature primordia formation is primarily influenced by seasonal changes in environmental conditions. In temperate climates most mushrooms fruit during the cool, wet fall whereas in tropical and subtropical climates mushrooms fruit during the rainy season. The fruiting period ends when the season changes and environmental conditions become too hot, too cold or too dry. The mycelium then lies dormant or grows slowly, reactivated only by the warming of spring and summer. These seasons are times for the mycelium to expand its network, absorb nutrients and rebuild its energy reserves. Once the cool wet conditions of fall return, these reserves are used to support another crop of mushrooms.

### Basic Pinning Strategy

Mushrooms fruit indoors in response to much the same conditions that trigger fruiting in the wild. Several environmental factors, working in combination, provide an ideal environment in which mushrooms flourish. Most, if not all cultivated mushrooms fruit at lower temperatures than the optimum for the growth of mycelium. Usually, a drop in temperature is accompanied by rain or an increase in humidity. Water is essential for the absorption of nutrients by the mycelium. And vaporous water creates the humid microclimate that is so critical for the developing primordia. Primordia have a low tolerance to CO<sub>2</sub> and need ample fresh air. And while the mycelium has no requirement for light, many species need light to initiate pinheads and to mature into healthy mushrooms. Mushrooms form only when there is a coincidence of all these factors. Cultivators create an artificial environment that prolongs these optimum conditions so that mushrooms are given the best possible environment in which to grow.

Primordia formation strategies are well defined for species now under cultivation. These procedures are similar in their approach and differ only in certain environmental requirements. Given that the substrate has sufficient nutrients, the interaction of water, humidity, temperature, fresh air, CO<sub>2</sub> and light all play determining roles in the fructification process. (In some cases, specific microorganisms must be present before fruiting can occur). The modification of any one of these factors beyond the fruiting requirements can inhibit or stop the process. Hence, the cultivator must have precise control over conditions within the growing room if this critical phase is to be carried out successfully.

---

---

## PRIMORDIA FORMATION PROCEDURES

*Agaricus brunnescens* culture illustrates the interplay of environmental factors in pinhead initiation. It serves as a useful model for setting primordia in many species, especially those using a casing layer. In each of the following stages, the main considerations are highlighted and then discussed in detail. Although *Agaricus* does not require light, and since most cultivated mushrooms do, this requirement has been listed as the last parameter.

### Stage I: Preparation

Following its application, the casing is conditioned to allow even mycelial growth into it. Once mycelial growth is well established, the casing layer microclimate and the growing room are carefully managed to meet the following requirements.

1. The casing layer is at optimum moisture capacity.
2. The casing layer surface is rough and porous.
3. The relative humidity of the growing room's air is 95%.
4. The substrate is incubated in total darkness.

During the casing colonization period, the casing layer is being conditioned for pinhead initiation. Gradually, the moisture content is brought up to the optimum and a microclimate with high relative humidity is carefully maintained. Water in the casing moves by capillary action to the surface where it is drawn into the air by evaporation. This constant movement slowly depletes the casing of the moisture needed to protect pinhead development. Therefore, in conjunction with an optimum casing moisture level, the relative humidity of the room must be held at 95%. Lower humidities must be accompanied by light but regular waterings. The higher the humidity (rH), the less water will be lost to evaporation.

Given optimum moisture conditions in and directly above the casing layer, the next step is to prepare the casing surface. Whether by initial application or by ruffling at a later time, the casing surface should be rough and open—with minute mountains and valleys. A rough open casing has more surface area where pinheads can form, provides a humid environment conducive to that formation and allows the diffusion of metabolic gases.

### Stage II: Environmental Transition—The Prelude to Setting Primordia

Pinhead initiation techniques should begin when the mycelium reaches the valleys of the casing surface. Once the mycelium is clearly established in the valleys, the cultivator can begin the first steps leading to the setting of pinheads. Within this one to two day period, the

1. Substrate and air temperatures are lowered to the fruiting range.
  2. The humidity is maintained at the 95% level.
  3. The carbon dioxide content of the room is reduced by the introduction of fresh air.
  4. The room is lighted on a 12 hour on/off cycle.
-

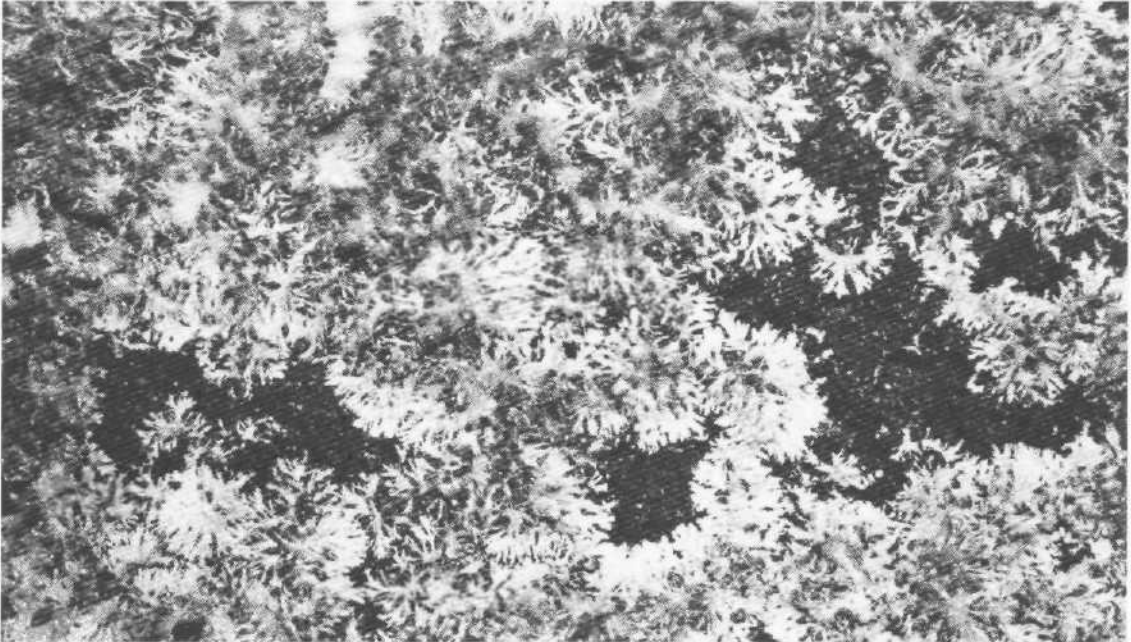
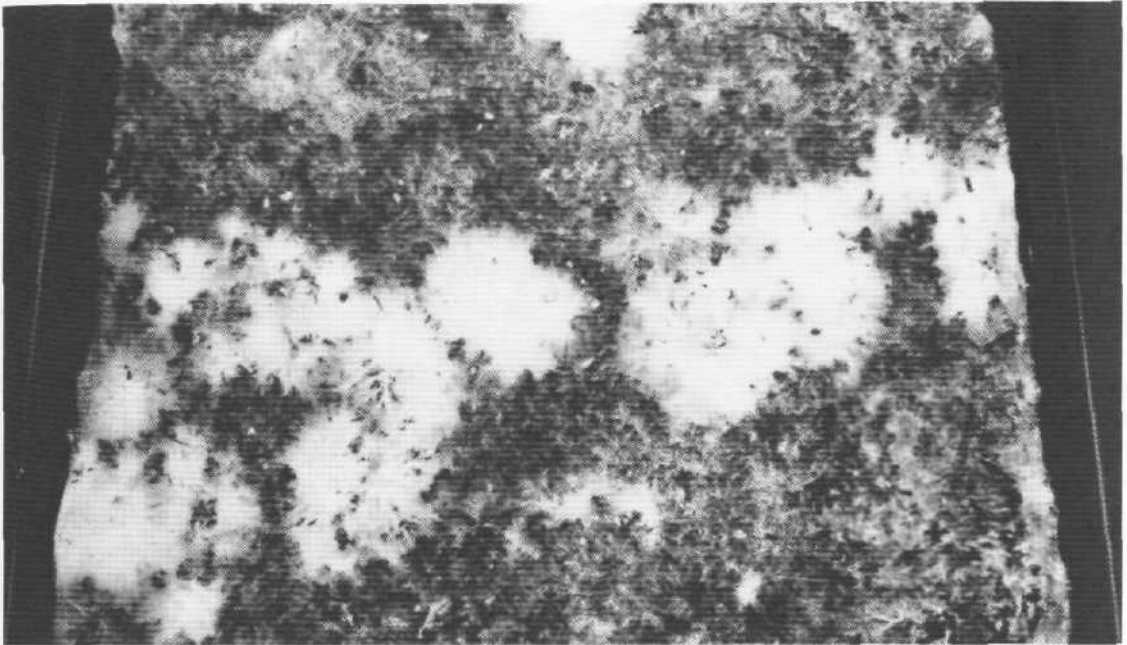

**Figure 130 Overlay.**

Mycelium breaking through the casing surface early should be lightly sprinkled with moist casing. Uneven growth through the casing layer is usually an indication of a casing with irregular depths. By "patching" shallow areas, an even mycelial spread is assured. Note that **the more even the distribution of the mycelium in the valleys of the casing's surface, the more even the pin-set and the greater the first and second flushes.**

The exact time for initiation varies with the strain and according to the experience of the individual grower. Some strains continue to grow vegetatively for a period after the initial temperature shock whereas others stop immediately. For this reason, some cultivators initiate when 20% of the valleys show mycelial growth while others wait until 90% are run through with mycelium. Normally within 12-48 hours from the time the mycelium is first visible in the valleys, the initiation sequence is started.

The first step in the pinhead initiation process is to lower the substrate and air temperature from the mycelial growth optimum to the fruiting range. This temperature "shock" is accomplished by ventilation with a large volume of cool fresh air, thereby lowering the room's temperature to a point 5-20 ° below the optimum for spawn running. (For *Agaricus brunnescens*, this would mean dropping air temperature from 70 °F. to 64 °F.). Whatever the air temperature may be, the bed temperature is normally several degrees warmer. The length of time needed to affect this change is determined by the total volume of substrate and the temperature of the air being introduced. Within 48 hours, the substrate temperature should fall to fruiting temperatures, effectively slowing vegetative growth. This change signals to the mycelium that it is time to fruit.



**Figure 131** Cased grain culture of *Agaricus brunnescens* showing overlay and stroma.

Fresh air also removes high concentrations of carbon dioxide and other metabolic gases from the room. Since *Agaricus brunnescens* does not pin properly at  $\text{CO}_2$  concentrations above 2000 ppm, lowering the carbon dioxide content of the room's air to under 2000 ppm is critical. The inhibitory effect of carbon dioxide on mushroom formation gives *Agaricus* growers a high degree of control over the pinning process. Not until carbon dioxide is removed will pinheads form. If carbon dioxide levels remain high, the mycelium will totally cover the casing surface, a condition called overlay.

The mycelial mat formed by overlay makes the casing impervious to water and produces few pinheads. Overlay also occurs if the casing surface is too dry, the humidity (rH) is too low or the air temperature remains too high. Overlay can be counteracted by patching, but the cause must be diagnosed and carefully corrected if the culture is to be revived. Few flushes will be as great from a casing with overlay as from a casing properly managed.

### Stage III: Primordia Formation (Knotting)

Once substrate temperatures have been lowered and  $\text{CO}_2$  levels have been reduced, primordia will begin to form. Maintain:

1. A constant fresh air supply to remove metabolic gases, and  $\text{CO}_2$  at levels less than 1000 ppm.
2. A constant temperature in the growing room that is within the fruiting range-

3. A relative humidity of 95%.
4. A 12 hour on/off light cycle.

The combination of temperature drop, high humidity and reduction of metabolic gases by a constant supply of fresh air now provides an environment conducive to pinhead formation. These parameters should be held constant until the pins are set. Any abrupt changes in temperature or humidity will be harmful to primordial growth. Pinhead initials form in the humid valleys of the casing layer and are visible as small knots of mycelium. This is the earliest stage of fruiting. Within five days these knots enlarge into small mounds or buttons that soon differentiate into mushrooms.

Due to slowed mycelial growth in the cooled substrate, carbon dioxide evolution is greatly reduced. Consequently, the fresh air supply can be moderated to the minimum level necessary to maintain 1000 ppm of carbon dioxide. At this time, oversupply of fresh air can lead to high evaporation rates and excessive drying. The humidity should **never** be allowed to fall below 90%. If dry air becomes a problem, a light misting of the casing surface, two to five times daily, should keep the microclimate moist. In fact, some growers knock down the mycelium with a forceful watering on the first day of initiation. Others mist daily as a standard practice. However, once pinning has begun, any forceful watering will kill a number of developing pins, and damage others. Given sufficient casing moisture and a high humidity, these watering practices become unnecessary.

## Stage IV: Pinhead Development

After the pinheads have grown to pea size (3-5 mm.), their further development is primarily dependent on air temperature and relative humidity. To insure that they mature into healthy mushrooms, the

1. Air temperature is held constant within the fruiting range.
2. Relative humidity is lowered to 85-92%.
3. A constant fresh air supply with CO<sub>2</sub> below 2000 ppm.
4. A 12 hour on/off light cycle.

The humidity is lowered to 85-92%, thereby increasing the evaporation rate, an essential requirement for pinhead maturation. If humidity remains too high, pinhead development will be retarded. The easiest way to reduce humidity is to raise the air temperature by 1-2 °F. or to increase air movement within the room. Under no circumstances should pockets of stagnant air be allowed to form. Evaporation is negligible in stagnant air pockets which are also excellent breeding grounds for mushroom pathogens.

At this time, a slightly higher level of carbon dioxide is desirable (in the 1500-2000 ppm range) and fresh air can be cut back accordingly. Given proper CO<sub>2</sub> levels, and sufficient evaporation, the pins continue to develop. The exact rate of growth depends on the air temperature in the room. Work done by Lambert (1938) has shown that a pinhead of *Agaricus brunnescens* with a diameter of 2 millimeters fully develops into a mature mushroom in twenty-two days at 50 °F., in ten days at 60 °F. and in six days at 70 °F. Although mushrooms develop more quickly at 70 °F., overall yields diminish. Optimum temperature for cropping in *Agaricus brunnescens* is 62-64 °F.

---

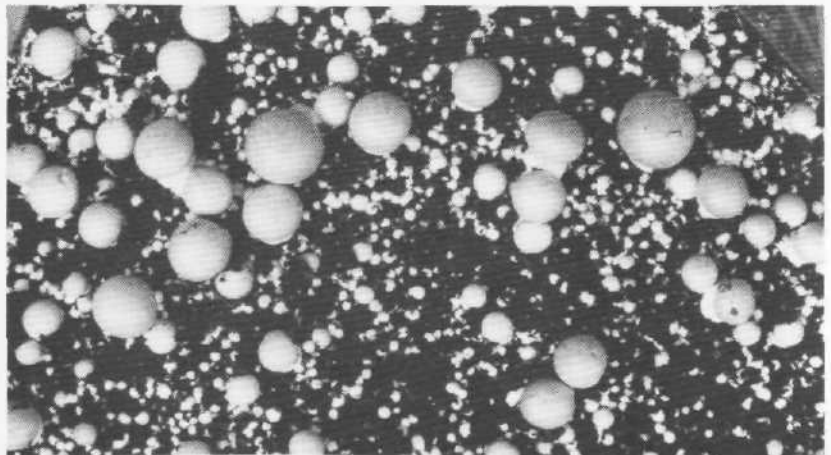
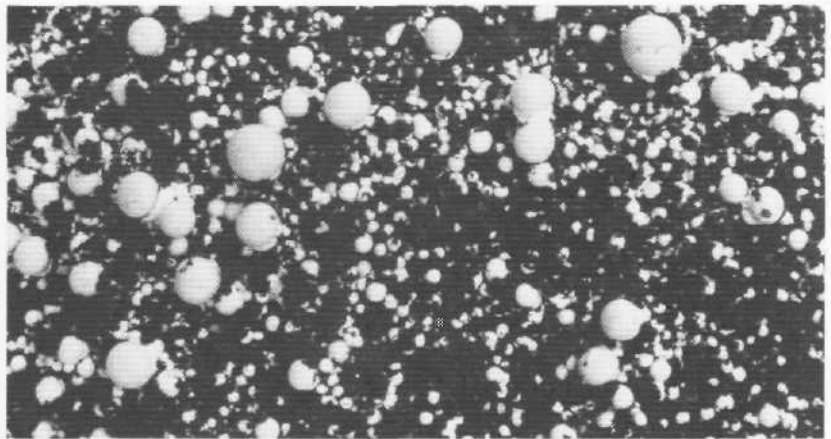
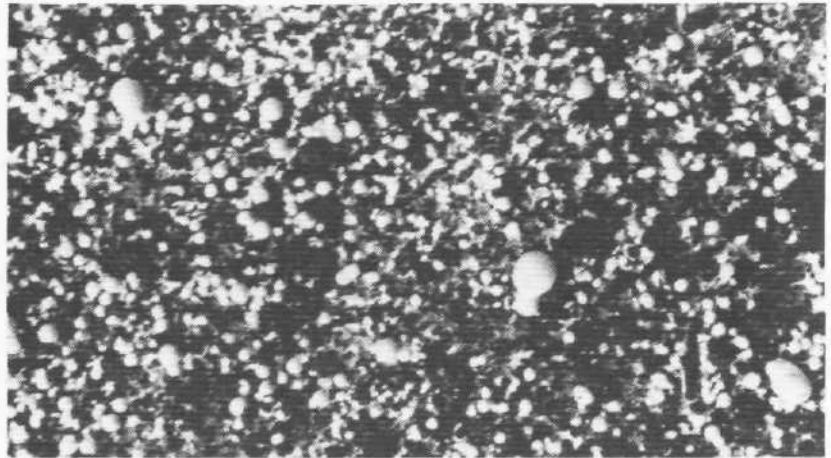

Figure 132, 133 & 134 Three day pinhead development sequence in *Agaricus brunnescens*.

Change-over from Stage III to Stage IV occurs within this time frame.



## THE RELATIONSHIP BETWEEN PRIMORDIA FORMATION AND YIELD

The importance of the primordia formation period can not be over-emphasized. For maximum yields an optimum number of pinheads must be set, matured and brought to harvest. Certain relationships exist between the pinning process and yields. These are:

1. **During the primordia formation period, pinheads for the first and second flush are being generated.** The second flush primordia are present as thickened mycelial knots which develop after the first flush is harvested. Once the first flush is off the beds, the second set of primordia begin to enlarge and within days attain button size. Because 60-75% of the total yield is normally harvested from the first two flushes, the few days of pinhead initiation are the most critical in the growing of mushrooms. Hence, all environmental factors must be carefully monitored to insure the best possible pin-set.

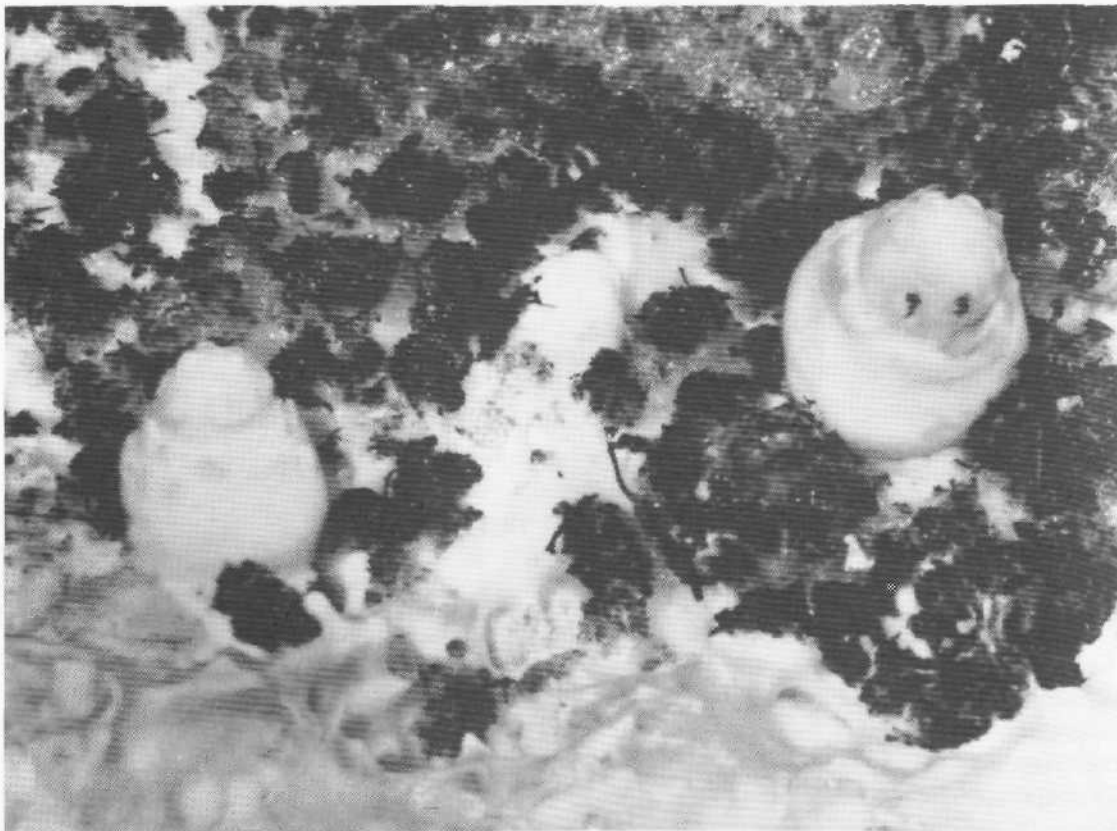

Figure 135 Three pinheads of *Coprinus comatus* forming on cased section of compost. Note mycelial knot in upper center.

- 9 **The greater the number of pins set for the first flush, the higher the yield**, provided sufficient **nutrients** are available to support their growth. However, **with** more pinheads **competing** for the same nutrient base, the smaller are the mushrooms arising from it. Fewer pinheads result in larger mushrooms, but **lower** total yields.
- 3 **The substrate will only support the development of a certain number of primordia per flush.** Under normal circumstances with an even pin-set, pinheads may "abort" because of insufficient **nutrients** or **late** formation.
- 4 **Pins that form early delay the growth of neighboring primordia.** Good examples of this can be found in **shallow** areas or along the borders of the substrate container. Removing these relatively few "volunteers" before they develop is advantageous to the remaining primordia that constitute the first flush.

## THE INFLUENCE OF LIGHT ON PINHEAD INITIATION

Mushroom species requiring light for primordia formation are said to be **photosensitive**. Although light is not necessary to induce fructification in all mushrooms (i.e. *Agaricus brunnescens*), certain spectra have proven to be stimulatory to pinhead initiation and are critical for the normal development of the fruitbody. *Psilocybe cubensis* and *Pleurotus ostreatus* are two such **photosensitive** species.

A thorough investigation on the photosensitivity of *Psilocybe cubensis* can be found in a master's thesis by E.R. Badham (1979). His work reinforces the conclusions of **other** researchers working with the Basidiomycetes: more pinheads are **initiated** upon exposure to blue and ultra-violet light with distinct peaks at 370, 440 and 460 nanometers. Badham showed **that** light stimulation at **these** wavelengths for as little as half a millisecond per day caused primordia to form. In contrast, **red**, infra-red and green light having wavelengths greater than 510 nanometers were **ineffective**.

With this knowledge, the cultivator of photosensitive species can develop initiation strategies incorporating the influence of light. Ideally a fully colonized substrate should be incubated in total **darkness** and exposed to light only after the mycelium first shows through the casing layer. If the cultivator wants to check the culture without the chance of premature pinning, red light is recommended (The proper location and type of **light** is discussed in more detail in Chapter IV).

# CHAPTER X ENVIRONMENTAL FACTORS: SUSTAINING THE MUSHROOM CROP



Figure 136 Wild strain of *Agaricus brunnescens* fruiting in bag of cased compost.

For the home cultivator the onset of cropping is a time of excitement and anticipation. It is also a time for increased attention to the finer details of environmental control. Temperature, humidity, light and airflow in the growing room all play vital roles which together determine the nature of further mushroom development.

## Temperature

During the vegetative growth period, the substrate was held in the optimum range by careful manipulation of the air temperature. But once the change to generative growth is initiated, the substrate temperature becomes less important and air temperature becomes the controlling factor.

The time it takes button sized mushrooms to mature is influenced primarily by the air temperature of the growing chamber. Each species has an optimum temperature for fruitbody development that lies within a broader growing range. Knowing the temperature parameters as outlined in Chapter XI, the cultivator can speed or slow development depending on which end of the cropping range is chosen. Lower temperatures can be used to postpone or lengthen the harvesting period and allow for maximum quality control. High temperatures serve to shorten the cropping period by promoting rapid, intense flushes. However, the dangers of high temperatures include the risk of heat building up in the substrate and consequent CO<sub>2</sub> generation, as well as the ability of insects and contaminants to grow and reproduce at faster rates. Commercial *Agaricus* growers commonly lower the air temperature by 2 °F. 48 hours prior to the peak of the first and second flushes. Further flushes are then run hotter to speed the crop to completion. It is important that the cultivator evaluate the heat generating capabilities of the crop and insure that the environmental control system is capable of handling them.

## Flushing Pattern

The mushroom crop grows in cycles called flushes or "breaks". Depending on the species being grown these flushes normally come in seven to ten day intervals with each successive flush bearing fewer mushrooms. The manner in which these flushes appear is determined during the pin initiation period. Even pinning sets up a uniform pattern of flushing that continues throughout the cropping cycle. Uneven flushing creates difficult situations for proper watering and environmental control. To encourage even flushing, early forming pinheads are picked off as buttons unless it appears that these pins constitute the flush itself. Poor first flushes are indicative of faulty pinning procedures and lead to lower total yields and a longer cropping period as the cultivator tries to maximize yields from the following flushes. But keep in mind that many times it is the progressive build-up of competing contaminant organisms that eventually bring mushroom growth to a halt. For this reason, the goal is to maximize yields in the early flushes.

To further increase the flushing speed the actual harvest period in each flush should be kept short and concise. Late developing mushrooms are removed with or on the day after peak production. The sooner the flush is completely removed the quicker the next one will appear and the short-

---



Figure 137 *Agaricus brunnescens* affected by high CO<sub>2</sub> concentration. Note long stems and underdeveloped caps.

Figure 138 The effect of dry air on *Psilocybe cubensis* caps, a condition known as "scaling".

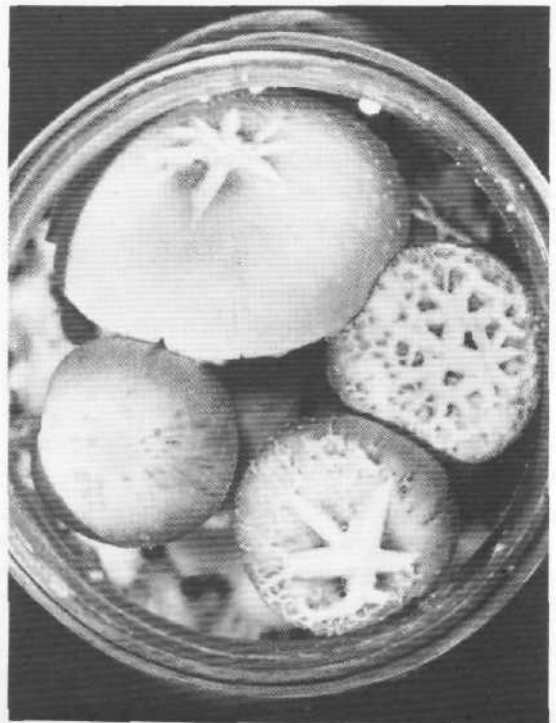

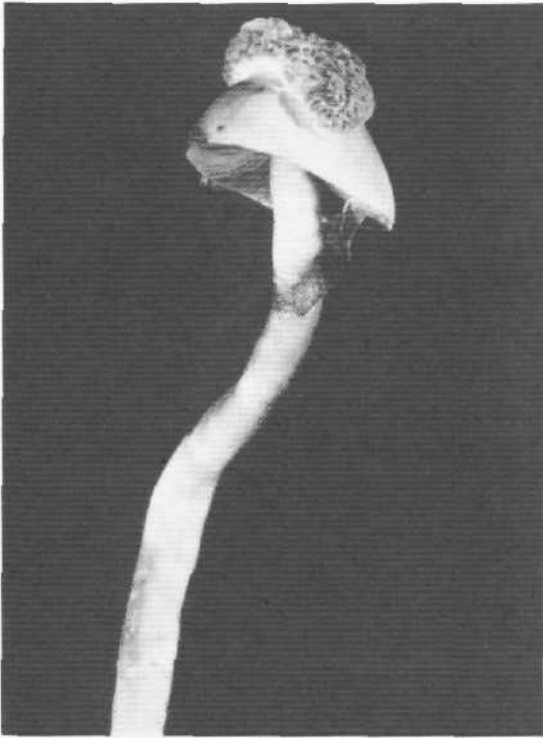

**Figure 139** Rosecomb on *Psilocybe cubensis*, an abnormality caused by contact with chemicals, especially those that are petroleum based.

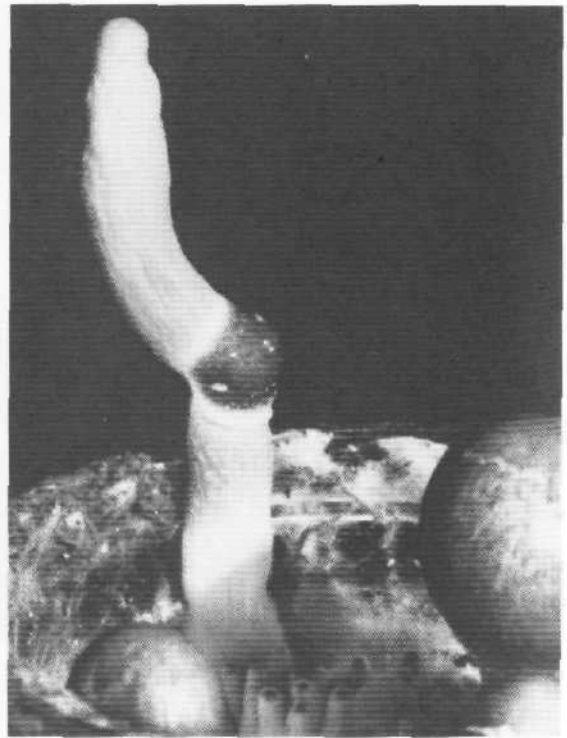

**Figure 140** Fruitbody abnormality occasionally seen in *Psilocybe cubensis*.

er the overall cropping cycle. Stunted undeveloped mushrooms are also cleared from the cropping surface between breaks with care not to disturb The casing. Small dead pinheads should be left in place and cause little harm. (As a rule, an aborted mushroom can be removed as long as the casing is not touched in the process.) At no time should the casing be over-handled in an attempt to clean. Such handling can spread disease spores and damage subsequent pin formation.

## Air Movement

Air movement in the growing room is designed to create an even flow across all levels of cropping surface. This even airflow counteracts temperature stratification and dead air pockets by equalizing the environment of the room. In this manner the crop can be managed as a whole, giving the grower greater control over the cropping cycle.

During the pin initiation period fresh air is introduced into the room to remove metabolic gases produced by the mushroom mycelium. Although gas production is reduced once this vegetative

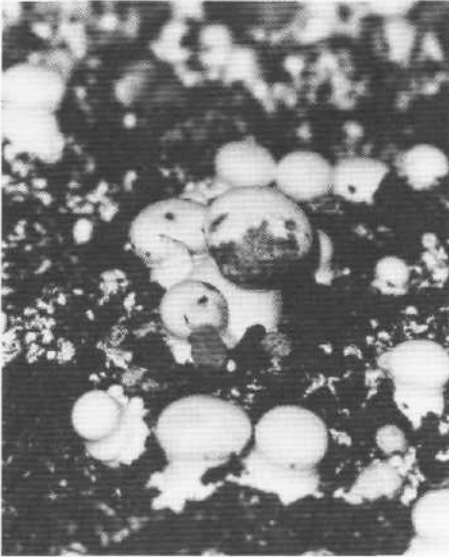

**Figure 141** Bacteria! blotch parasitizing *Agaricus brunnescens*.

**Figure 142** Characteristic phototropic response of *Psilocybe cubensis* toward light.

growth has been slowed, the maturing mushrooms create more carbon dioxide, the removal of which requires a continuous supply of fresh air. The number of these air changes varies depending upon the air/bed ratio and the  $\text{CO}_2$  requirement of the mushroom species being grown. *Agaricus bitorquis* needs only half the amount of fresh air required by *Agaricus brunnescens*. A common rate for *Agaricus brunnescens* is 4-6 changes per hour. For more  $\text{CO}_2$  tolerant species such as *Psilocybe cubensis*, 2-3 changes per hour is sufficient. (The most accurate method for determining fresh air requirements employs the multiple gas detector. This instrument measures  $\text{CO}_2$  content of the air in parts per million (ppm), from 300 (natural level) up to 20,000 ppm. See Appendix for sources.)

Because many mushrooms are sensitive to carbon dioxide, the physical development of the mushroom can also be used as a guide. High  $\text{CO}_2$  environments produce long stems and small underdeveloped caps in *Agaricus brunnescens* and *Pleurotus ostreatus*. *Pleurotus* exhibits similar symptoms in conditions of low light intensity.

In general, too much fresh air is preferable to insufficient air supply. However, fresh air displaces the existing room air which is then exhausted from the room. Unless this fresh air is preconditioned to meet the requirements of the species, one will be constantly disrupting the growing environment and thereby over-working the heating and humidification systems. For this reason the air circulation system should be designed to recirculate the room air. This is accomplished by a mixing box with an adjustable damper that proportions fresh and recirculated air. In this regard,  $\text{CO}_2$  tolerant species give the grower a distinct advantage in maintaining the correct environment because they need less fresh air for growth.

An important effect of air circulation and fresh air supply is the evaporation of moisture from the cropping surface. Excessive humidity without adequate air movement and evaporation retards mushroom development. Saturated stagnant air pockets are also breeding areas for contaminants

like the Forest Green Mold (*Trichoderma*) and Bacterial Blotch (*Pseudomonas*). As stated in the previous chapter on pinhead initiation, once the primordia are set, the relative humidity should be lowered to 85-92% and held constant within this range throughout cropping. Besides the creation of a cool surface by "evaporative cooling", evaporation aids in the transport of nutrients (in solution) from the substrate to the growing mushrooms. If the evaporation rate is too high and the humidity falls below 85%, excessive drying occurs, causing small stunted mushrooms and cracked scaly caps. A dry cropping surface further reduces yields and is difficult to recondition. In this respect, it is critical for the grower to reach a balance between air circulation, fresh air and humidification. This is but one aspect of the "Art" of mushroom culture.

## Watering

Maturing mushrooms have water requirements that must be met if maximum yields are to be achieved. Mushrooms grown on uncased substrates draw their moisture from the substrate, whereas those grown with a casing draw equally from both. Uncased substrates are more susceptible to dry air and therefore require a relative humidity of 90-95% as well as periodic misting of the cropping surface. If the cropping surface dries and forms a dead mycelial mat, it can be reopened to further flushing by raking or scratching. This technique is often used by *Pleurotus* growers to stimulate later flushes.

The advantages of using a casing layer are many. Protected from atmospheric drying, the substrate moisture is channeled solely to the mushroom crop. And, the water reservoir provided by the casing not only supplies the mushroom flushes but also serves to keep a high humidity in the cropping surface microclimate. In order to sustain these benefits, the grower must learn to gauge casing moisture and know when to water.

Other than light mistings, any substantial waterings before the button stage can result in damaged pins. But once the mushrooms have reached button size, it is time to begin building the casing moisture back up to the peak reached at pre-pinning. The aim is to reach capacity just prior to the main harvest. This is accomplished by a series of daily, light to moderate waterings with a fine misting nozzle. Commercial *Agaricus* growers have traditionally used a rose-nozzle but many have now switched to nozzles with finer sprays and variable volume outputs. This enables the grower to add moisture without damaging the casing surface. In this regard, high water pressures and close nozzle proximity to the casing should be avoided.

The goal is to keep the surface of the casing open and porous throughout the cropping cycle. Putting on too much water at once is the most common cause of panning. By watering 2-4 times/day rather than just once, the casing can slowly absorb the water without damage to the surface.

After the first flush is harvested the casing should be kept moist with light mistings until the next flush reaches the button stage. The casing moisture is then built up again. Each new flush is treated in this manner, although later flushes will have fewer mushrooms and therefore require less water. At no time should the casing be allowed to dry out. Mushrooms pulled from a dried casing carry large chunks of casing with them, creating gaps in the cropping surface and at times exposing the

---



substrate to possible colonization by contaminants. If the substrate is exposed during picking, the substrate should be filled with moist casing. To recondition a dry casing, moisture should be added slowly.

One of the common contaminants in mushroom growing is Bacterial Blotch (see Chapter XIII). Blotch results from mushroom caps that remain wet for extended periods of time. *Agaricus* growers attempt to dry recently watered mushroom caps as quickly as possible by lowering the humidity of the room. This is accomplished by increasing air circulation and introducing more fresh air or by raising the air temperature 1-2° F. *Agaricus* growers also stop watering once the mushroom cap has reached adolescence because wet mushroom caps become prime sites for disease. Small scale growers may be able to water around maturing mushrooms without directly hitting the caps. If Bacterial Blotch or other diseases appear on the mushrooms or the casing soil, these areas should not be watered. Watering contaminated regions will spread the infection further. A common strategy for serious disease outbreaks is to lower the relative humidity and run the casing drier than normal. *Agaricus* cultivators also use slightly chlorinated water (150 ppm).

## Harvesting

The way an individual picks mushrooms can dramatically affect future flushes. Damage to resting pinheads and disturbance of the casing soil must be minimized during picking. Often times pinheads are in close proximity to developing mushrooms and enlarge directly after the mature ones are picked. Should any pinhead be harmed, the grower will have lost a potential fruitbody. Moreover, these damaged pinheads are easily parasitized by fly larvae and other contaminants. The best pickers are meticulous, unhurried, and above all treat the mushrooms with care. Carelessness in picking, when multiplied by hundreds of cultures, can be costly indeed.

The most important factor in harvesting mushrooms is timing. *Agaricus brunnescens* should be picked before the veil breaks and the stem elongates. *Psilocybe cubensis* is morphologically distinct from *Agaricus* species, having a longer stem, a less fleshy cap and a more delicate veil. It is natural and desirable to have tall stands of *Psilocybe* mushrooms while this is not the case with *Agaricus*. Cultivators of these two species, however, share many things in common. One particular problem is the massive release of spores from the mature mushrooms. These spores often times cover the casing layer and can inhibit further pinhead development. High spore loads can also cause allergic reactions among workers. For these reasons, one should pick the mushrooms at the stage when the veil begins to tear or soon thereafter.

The nature of the crop determines how the mushrooms should be picked. Flushes with mushroom in varying stages of development are more difficult to harvest. This is especially true if the promordia formation period was interrupted by fluctuations in the environment. One example is a phenomenon common to *Psilocybe cubensis* culture in mason jars. Mushrooms sometimes form between the casing and the glass. These "border breaks" are due to high humidity pockets and premature light stimulation. In tray culture where mycelium is not exposed to side light and proper moisture is easily managed border breaks are uncommon. Mushrooms then grow uniformly from the surface of the casing layer where they can be easily picked.

**Harvesting techniques:**

1. Equipped with a basket and short bladed paring knife, grasp the base of the stem, and with a twisting motion, pull the mushroom from the casing layer being careful not to disturb neighboring pinheads.
2. Trim the stem base, removing only flesh to which the casing or **substrate** is attached. Mushrooms having thin stems are best cleaned using a knife in a downward scraping motion. All trimmings should be placed in a sealed plastic bag and removed from the cropping area.
3. Mushrooms growing in clumps or **clusters** should be broken apart and harvested individually when possible. Special care must be taken with those clumps containing both mature and immature mushrooms. Leave immature mushrooms attached to the casing layer or substrate to insure continued growth.

## Preserving Mushrooms

If not served within four days, mushrooms can be preserved by **drying**, freezing or canning. Air drying of mushrooms is the method most widely used by home cultivators and field hunters. Since most mushrooms are **90% water**, they must be dried within a few hours or fly larvae and bacteria will consume them. Provided mushrooms are placed in a flow of warm, dry air, this large fraction of water soon evaporates into the air. Dried mushrooms are smaller, **lighter** and less fragrant than fresh ones. Once dried, **they** are sealed in airtight moisture proof plastic containers and refrigerated. Mushrooms will be preserved for years in this manner. When needed, simply rehydrate them in water before cooking. They will regain much of their original size and flavor.

Commercially **available** food dehydrators are well suited for drying mushrooms. Their only disadvantage is that the trays are often too close together, necessitating the **cutting** of large mushrooms into thin slices. Or, one can build a dehydrator solely designed for this function and customized to an individual's particular needs. A good dryer should be able to dry the mushrooms in 24-48 hours by passing warm air no hotter than **110°F**. Open air drying at room temperature is also feasible using dehumidifiers in combination with air circulation fans. "Flash" drying at high temperatures should be avoided since the mushrooms lose much of their nutritive value and, as the case may be, much of their psilocybin content.

Freezing is another method of preserving mushrooms. But unless the mushrooms are first dried, frozen mushrooms are soggy and unappealing upon thawing. In freezing, the water constituting 90% of a mushroom's mass becomes crystallized. Frozen mushrooms are held together more by ice crystals rather than their own cellular **structure**. Since ice expands upon **crystallization**, cells break under the stress. Because frozen mushrooms disintegrate into a formless mass when thawed, they are mostly used in soups or stews.

The best of both drying and freezing is freeze drying. This is the ideal method for preserving the flavor, nutrition, form and/or psilocybin content of mushrooms. Because of the expense, only a few commercial mushrooms, such as shiitake (*Lentinus edodes*) are freeze dried.

---

Freeze dryers operate on the principle of first flash freezing fresh mushrooms which are then placed onto heated trays in a cooled, high vacuum chamber. The frozen water within the mushrooms begins to melt from the heat generated from the trays. But instead of becoming a liquid, the water is immediately transformed into a vapor that is pumped out of the freeze drier. Freeze drying preserves much of the original cell structure and hence mushrooms dried in this manner are often life-like in appearance. Since commercial freeze driers are prohibitively expensive, few home cultivators can afford them. Many people have discovered, however, that mushrooms placed in a frost-free refrigerator are almost as well preserved.

Canning is another method for storing mushrooms. Mushrooms preserved by canning must be carefully cleaned beforehand, precooked for 3 or 4 minutes in boiling water, then inserted into glass jars with a small amount of vinegar and sterilized in a pressure cooker. (Sterilization for mushrooms is usually 30-40 minutes at 10 psi. Consult a book on mushroom cookery for further information on canning mushrooms). Canned mushrooms, especially those that have been pickled, are preferred by many epicureans to those preserved by other means.

No matter what the technique, fresh mushrooms are undoubtedly better tasting than preserved mushrooms. If one chooses to dry, freeze or can, young mushrooms should be selected over old ones. Label each container with the species, the name of who grew or identified the mushrooms, the date and the place of origin. (One general rule recommended by all mycologists is: when eating wild mushrooms for the first time, always leave one or two small specimens aside in case illness ensues and a mycologist or a doctor needs to be consulted.)

---

# CHAPTER XI

## GROWING PARAMETERS FOR VARIOUS MUSHROOM SPECIES



Figure 143 *Stropharia rugoso-annulata* fruiting in a bed of wood chips.

**G**rowing parameters for mushrooms vary with every species. Through time spent in countless trials and from observations by both home and commercial cultivators, specific cultural requirements have been ascertained.

Mushrooms fruit in response to unique sets of conditions involving nutrition (substrate), temperature, pH, relative humidity, light and carbon dioxide. What follows are outlines pinpointing the optimal environmental ranges for each stage in the mushroom's life cycle. By adhering to these optima, a cultivator can maximize fruitbody production in a precise and deliberate fashion.

SPECIES: *Agaricus bitorquis* (Quel.) Saccardo  
 = *Agaricus rodmanii* Peck  
 = *Agaricus campestris* var. *edulis* Vitt.  
 = ***Agaricus edulis*** (Vitt.) Moller and Schaeff.

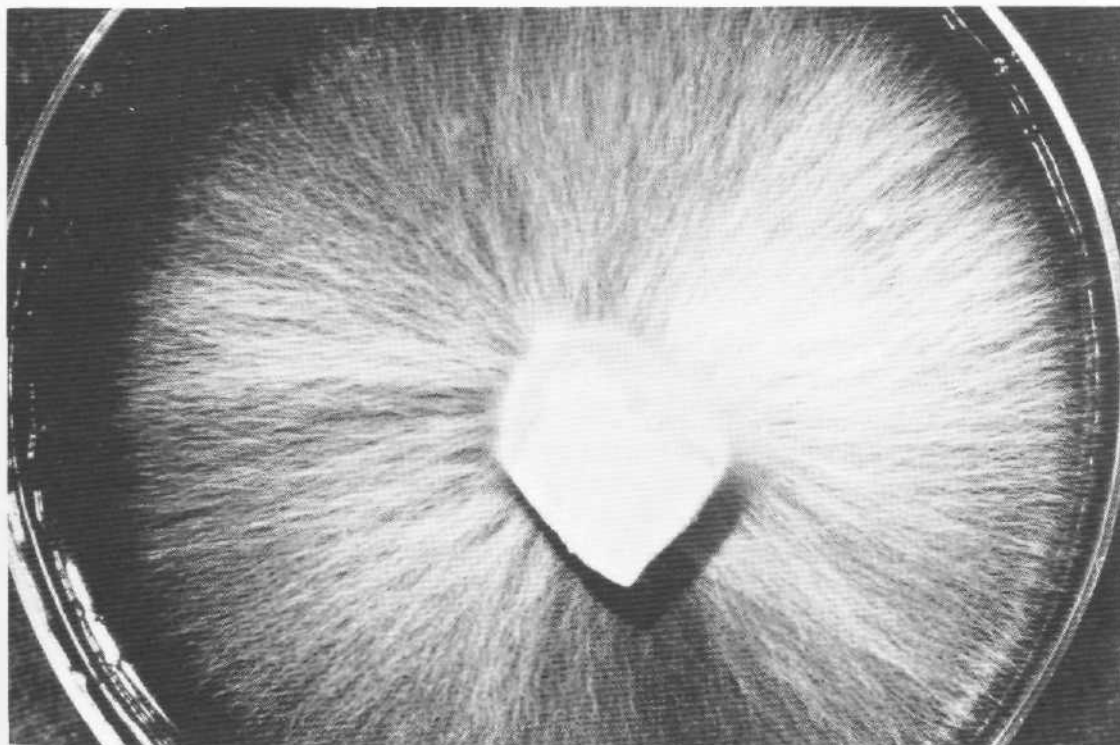

Figure 144 Linear (longitudinally radial) mycelium of *Agaricus bitorquis*.

**STRAINS:** Horst B30 (The first commercial strain to be developed by Gerda Fritsche at the Dutch Mushroom Research Center in Horst, Holland).

Horst K26, K32 (These are two second generation strains from Horst B30 and are distinctive from it in that they fruit earlier, give higher yields and have slightly longer stems. Spawn of this species is now available from Amycel.)

**COMMON NAME:** Rodman's Agaricus

**GREEK ROOT:** *Agaricus* comes from the greek word "agarikon" which scholars believed originated with a Scythian people called Agari who were well versed in the use of medicinal plants and employed a fungus called "agaricum", probably a polypore in the genus *Fomes*. The species epithet *bitorquis* means having two rings, for the double annulus that so distinguishes this species from close relatives like *Agaricus campestris*, the Meadow Mushroom.

**GENERAL DESCRIPTION:** Cap smooth, white, thick fleshed, convex to broadly convex to plane with age. The cap margin is incurved at first but soon *decurves*. The gills are pinkish at first, soon darkening to *chocolate* brown with spore maturity. The stem is *thick*, relatively short and adorned with a double membranous annulus. (The lower ring is often a thin annular zone). Its spores are dark chocolate brown in mass.

**NATURAL HABITAT:** Naturally found in lawns, gardens, roadside *areas*, *pastures*, in enriched grounds and on hard packed soil. A temperate species, widely distributed, *A. bitorquis* fruits primarily in the spring and to a lesser degree in the fall.

## GROWTH PARAMETERS

**Mycelial Types:** Rhizomorphic to linear; whitish to pale *whitish* in color.

**Spawn Medium:** Rye grain buffered with calcium carbonate and/or calcium sulfate. See Chapter III.

**Fruiting Substrate:** Nitrogen enriched wheat straw and/or horse manure based compost balanced to 71-74% moisture content.

**Method of Preparation:** See Chapter V on compost preparation. Pasteurization achieved through exposure to live steam for 2 hours at 140° F. throughout the *substrate*. Compost should be filled to a depth of 6-12 inches.

### Spawn Run:

*Relative Humidity:* 90-100%.

*Substrate Temperature:* 84-86°F. Thermal death limits have been established at 93° F. over prolonged period of time.

*Duration:* 2 weeks.

*CO<sub>2</sub>:* 5,000-10,000 ppm.

*Fresh Air Exchanges:* 0 per hour.

**Type of Casing:** After fully run, cover with the standard casing whose preparation is described in Chapter VIII. Layer to a depth of 1-2 inches. The casing should be balanced to a pH of 7.2-7.5.

### Post Casing/Prepinning:

*Relative Humidity:* 90-100%.

*Bed Temperature:* 84-86°F.

*Duration of Case Run:* 10-12 days.

*CO<sub>2</sub>:* 5000-10,000 ppm.

*Fresh Air Exchanges:* 0 per hour.

### Primordia Formation:

*Relative Humidity:* 95-100%.

*Bed Temperature:* 77-80°F.

*Air Temperature:* 75-77°F.

*Lighting:* None required.

*CO<sub>2</sub>:* less than 2000 ppm.

*Fresh Air Exchanges:* 2-4 per hour.

*Watering:* Regular misting (once to twice daily) of the beds stimulates primordia formation.

### **Cropping:**

*Relative Humidity:* 85-92%.

*Air Temperature:* 75-77 °F.

*CO<sub>2</sub>:* less than 3000 ppm.

*Fresh Air Exchanges:* 2-4 per hour.

*Flushing Interval:* Every 8-9 days.

*Harvest Stage:* Directly before the partial veil stretches.

**Yield Potential:** Average commercial yields are reported at 3 lbs/sq.ft. over a 5 week cropping period. Maximum yields are 4 lbs per square foot.

**Moisture Content of Mushrooms:** 92% water; 8% dry matter.

**Nutritional Content:** Thought to be similar to *Agaricus brunnescens*.

**Comments:** The development of *Agaricus bitorquis* has given commercial growers greater flexibility, especially those in warmer climates where elevated temperatures have been a limiting factor. An advantage of this mushroom is its resistance to virus (a devastating disease that attacks *A. brunnescens*) and its tolerance of high CO<sub>2</sub> levels. A disadvantage of growing this warmth-loving *Agaricus* is the higher incidence of disease endemic to the temperature range in which this species flourishes. *Agaricus bitorquis* is coarser, firmer, more strongly flavored and has a longer shelf life than its close relative, *A. brunnescens*.

**Genetic Characteristics:** Basidia tetrapolar (4-spored), forming haploid spores, heterothallic. The mating of compatible monokaryons can result in fruiting strains. Clamp connections absent. See Chapter XV.

### **For further information consult:**

P.J.C. Vedder 1978, "*Modern Mushroom Growing*", Educaboek, Culemborg, Netherlands. (English edition available from Swiss American Spawn Company, Inc., Madisonville, Texas.)

P.J.C. Vedder 1978, "*The Cultivation of Agaricus bitorquis*" in *The Biology and Cultivation of Edible Mushrooms* ed. by Chang and Hayes. Academic Press, New York.

Darmycol LTD. Spawn Lab Bulletin 1978, "*A Guide to Darlington and Somycol Spawn Strains*".



**SPECIES:** *Agaricus brunnescens* Peck  
= *Agaricus bisporus* (Lge.) Sing.

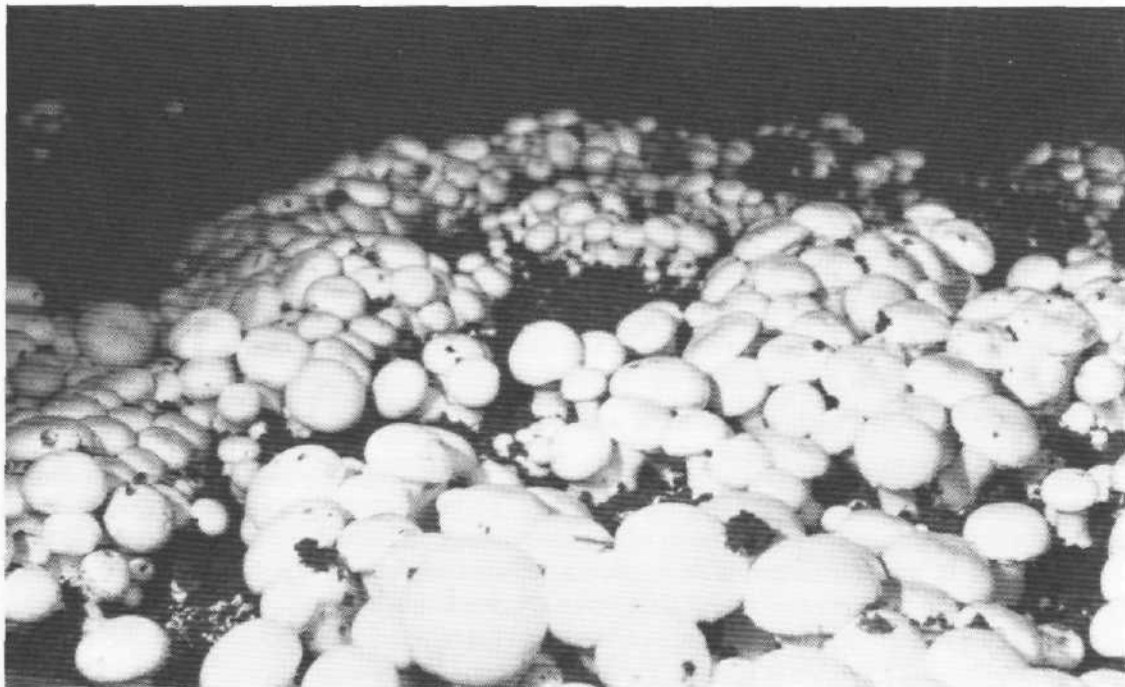

**Figure 145** *Agaricus brunnescens* fruiting in trays of compost.

**STRAINS:** Type or Brown Variety (var. *bisporus*)  
White Variety (var. *albidus*)  
Cream Variety (var. *avellaneous*)

**COMMON NAME:** The Button Mushroom.

**GREEK ROOT:** *Agaricus* comes from the greek word "agarikon" which scholars believed originated with a Scythian people called Agari who were well versed in the use of medicinal plants and employed a fungus called "agaricum", probably a polypore in the genus *Fomes*. The species epithet *brunnescens* comes from the latin "brunneus" or brown. Literally, the name means the fungus that becomes brown, probably referring to the color change of the flesh upon bruising. Also called *Agaricus bisporus* for the two spored basidia populating the gill faces.

**GENERAL DESCRIPTION:** A robust, thick fleshed *Agaricus* species, with thin gills that are pinkish when young, and darkening to sepia and then chocolate brown in age. The cap is characteristically brownish, whitish or cream colored. The cap surface is smooth to appressed squamulose and dry. This species has a short, thick stem which is adorned with a persistent membranous annulus from a well developed partial veil. Its spores are chocolate brown in mass.

**NATURAL HABITAT:** Naturally found in soils enriched with dung, on compost piles and in horse stables. A temperate species, widely distributed, *A. brunnescens* fruits from May until November over much of the northern hemisphere outside the tropical zone.

## GROWTH PARAMETERS

**Mycelial Types:** Moderately rhizomorphic; dingy white, sometimes with brownish hues.

**Spawn Medium:** Rye grain buffered with calcium carbonate and/or calcium sulfate. See Chapter III.

**Fruiting Substrate:** Nitrogen enriched wheat straw and/or horse manure based compost balanced to 71-74% moisture content. This species also fruits well on rye grain covered with an unsterilized peat based casing layer.

**Method of Preparation:** See Chapter V on compost preparation. Pasteurization achieved through exposure to live steam for 2 hours at 140°F. throughout the substrate. Compost should be filled to a depth of 6-12 inches.

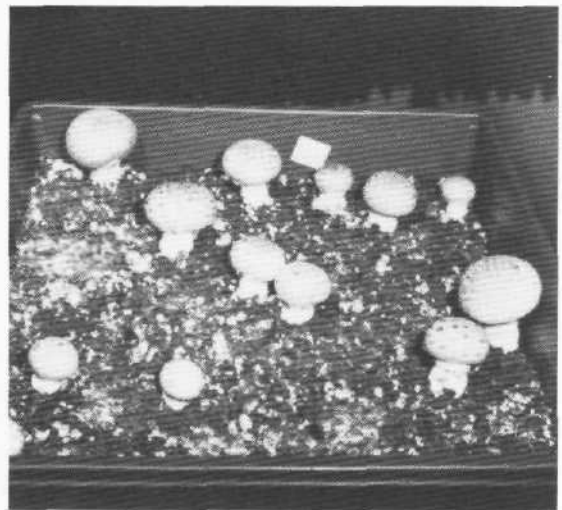
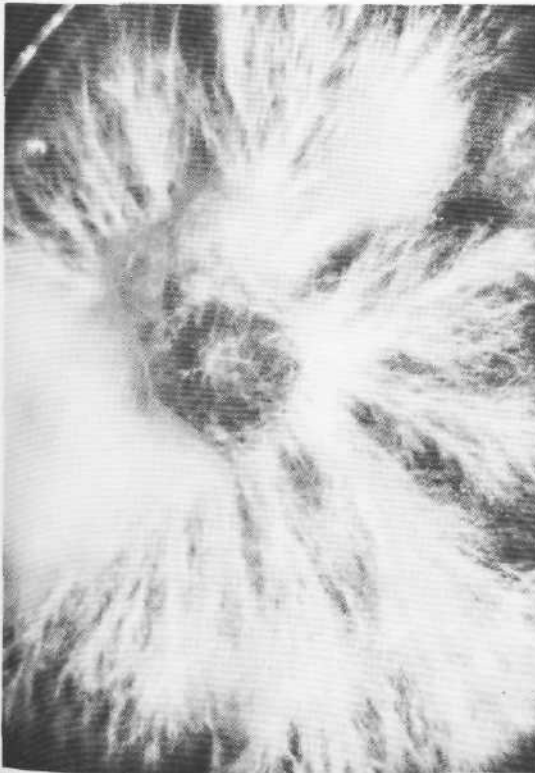

Figure 145a *Agaricus brunnescens* fruiting on cased rye grain spawn.

Figure 145b Characteristic *Agaricus brunnescens* mycelium.

**Spawn Run:**

*Relative Humidity:* 90-100%.

*Substrate Temperature:* 76-78°F. Thermal death limits have been established at 96°F. but damage can occur as low as 90°F.

*Duration:* 2 weeks.

*CO<sub>2</sub>:* 5000-10,000 ppm.

*Fresh Air Exchanges:* 0 per hour.

**Type of Casing:** After fully run, cover with the standard casing whose preparation is described in Chapter VIII. Layer to a depth of 1-2 inches. The casing should be balanced to a pH of 7.0-7.5.

**Post Casing/Prepinning:**

*Relative Humidity:* 90-100%.

*Bed Temperature:* 76-80°F.

*Duration of Case Run:* 8-12 days.

*CO<sub>2</sub>:* 5000-10,000 ppm.

*Fresh Air Exchanges:* 0 per hour.

**Primordia Formation:**

*Relative Humidity:* 95-100%.

*Compost Temperature:* 65-70°F.

*Air Temperature:* 62-65°F.

*CO<sub>2</sub>:* less than 1000 ppm.

*Fresh Air Exchanges:* 4 per hour.

*Light:* None required.

**Cropping:**

*Relative Humidity:* 85-92%.

*Air Temperature:* 62-65°F.

*CO<sub>2</sub>:* less than 1000 ppm.

*Fresh Air Exchanges:* 4 per hour.

*Flushing Interval:* 7-10 days.

*Harvest Stage:* Directly before the partial veil stretches.

*Light:* None required.

**Yield Potential:** Average commercial yields are 3 lbs/sq.ft. over a 5 week cropping period. Maximum yield is 6 lbs. per square foot.

**Moisture Content of Mushrooms:** 92% water; 8% dry matter.

**Nutritional Content:** 24-44% protein (dry weight); 56 milligrams of niacin per 100 grams dry weight.

---

**Comments:** Historically, this species and/or its close relatives were the first mushrooms to be cultivated in Europe during the late 1700's. It remains the most widely cultivated mushroom in the world Today, A broad range of commercially available strains exist, many of which have been genetically selected for certain advantageous characteristics, especially yield, color and stature.

This species does not form pinheads on agar media unless activated charcoal or select bacteria are present. A species sensitive to high levels of carbon dioxide, *Agaricus brunnescens* fruits only within narrow environmental parameters. As a secondary decomposer, this species fruits best on substrates that have been transformed by a succession of specific microorganisms.

The common button mushroom is the mainstay of the mushroom growing industry in this country.

**Genetic Characteristics:** Basidia bipolar (2-spored), forming diploid spores; secondarily homothallic. The mating of compatible dikaryons typically results in strains both more vigorous and higher yielding. Clamp connections absent. See Chapter XV.

**For further information consult:**

P.J.C. Vedder 1978, "*Modern Mushroom Growing*", Educaboek, Culemborg, Netherlands. (English edition available from Swiss American Spawn Company, Inc., Madisonville, Texas).

Fred Atkins, 1973, "*Mushroom Growing Today*", MacMillan Publishing Co., New York.

---

**SPECIES:** *Coprinus comatus* (Mull. ex Fr.) Gray



**Figure 146** Fully mature *Coprinus comatus* fruiting in a tray of compost.

**STRAINS:** On deposit at the American Type Culture Collection and available through various culture banks, both commercial and private.

**COMMON NAME:** The Shaggy Mane.

**GREEK AND LATIN ROOTS:** *Coprinus* comes from the Greek word "kopros" meaning dung and *comatus* from the Latin "coma" meaning shaggy or adorned with hair tufts. The genus *Coprinus* is noted for the several species that grow on dung and for deliquescing gills. The species epithet describes the shaggy texture of the cap's surface.

**GENERAL DESCRIPTION:** Cap medium to large in size, whitish, ovoid when young, soon elongating upwards and becoming parabolic. As the mushroom matures and spores are produced, the cap begins to disintegrate from the margin's edge by an autodigestive process known as deliquescence. The disintegrating portions progressively darken and eventually liquify. The cap surface is

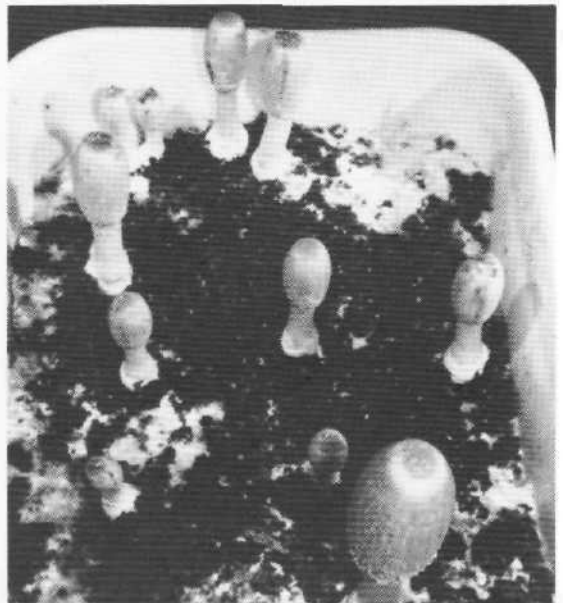
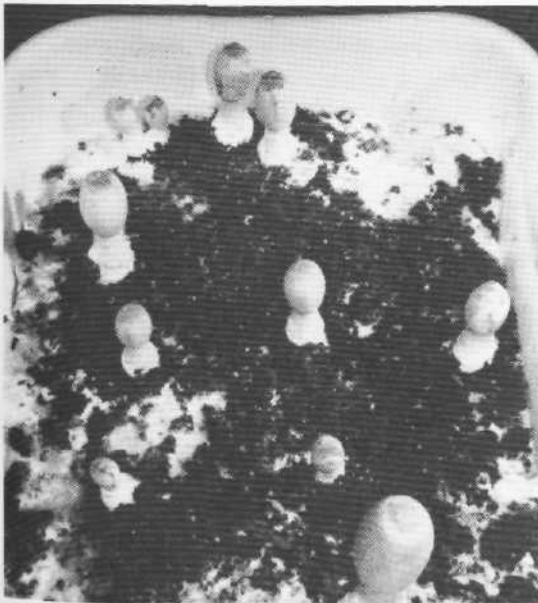
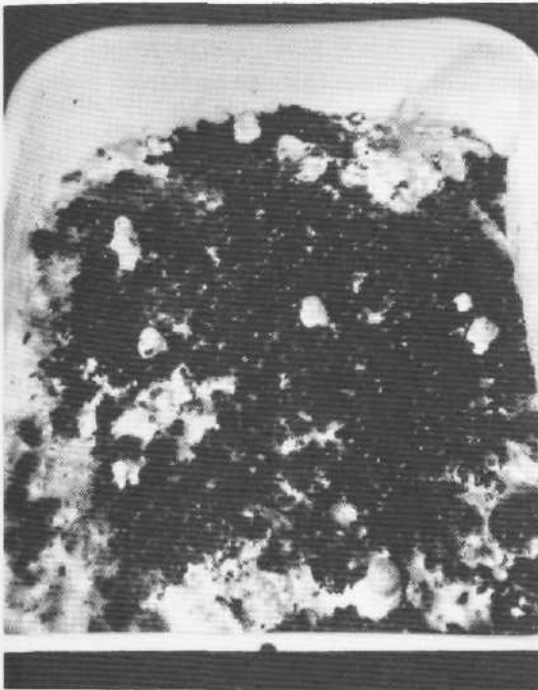

Figures 147-150 Four day developmental sequence of *Coprinus comatus* fruiting in a tray of compost.

smooth at The disc, scaly below, soon gray, darkening with maturity until black and thin fleshed. The gills are very crowded, whitish at first, soon gray, darkening with age to black. The partial veil membranous, often leaving a fugacious, membranous (collar-like) annulus that can be moved over the stem. The spore deposit is black.

**NATURAL HABITAT:** Common along roadsides, near debris piles, in lawns and in barnyards during the late summer and fall.

## GROWTH PARAMETERS

**Mycelial Types:** Linear to cottony, zonate-cottony mycelia; whitish in color.

**Spawn Medium:** Rye grain. See Chapter III.

**Fruiting Substrate:** Composted wheat straw enriched with horse and/or chicken manure, adjusted to 70% moisture content. Also, pasteurized chopped wheat straw supports fruitings of this species. Garcha et al. (1979) reported that composts having The distinct scent of ammonia after Phase II supported the greatest fruitings of *Coprinus comatus*.

**Method of Preparation:** See Chapters V & VI on the preparation of compost and straw. Pasteurization achieved through exposure to live steam for 2 hours at 140°F. Compost or straw should be filled to a depth of 6-12 inches.

### Spawn Run:

*Relative Humidity:* 90-100%.

*Substrate Temperature:* 76-80 °F.

*Duration:* 8-12 days.

*CO<sub>2</sub>:* 5000-10,000 ppm.

*Fresh Air Exchanges:* 0-1 per hour.

**Type of Casing:** After fully run, cover with the standard casing whose preparation is described in Chapter VIII. Layer to a depth of 1-2 inches. The casing should be balanced to a pH of 7.0-7.5.

### Post Casing/Prepinning:

*Relative Humidity:* 90-100%.

*Bed Temperature:* 76-80 °F.

*Duration of Case Run:* 10-12 days.

*CO<sub>2</sub>:* 5000-10,000 ppm.

*Fresh Air Exchanges:* 0-1 per hour.

### Primordia Formation:

*Relative Humidity:* 95-100%.

*Bed Temperature:* 65-67 °F.

*Air Temperature:* 62-65 °F.

*CO<sub>2</sub>:* less than 1000 ppm.

---

*Fresh Air Exchanges:* 4 per hour.

*Light:* Natural daylight or grow-light recommended on a 12 hour on/off cycle.

**Cropping:**

*Relative Humidity:* 85-92%.

*Air Temperature:* 62-65 °F.

*CO<sub>2</sub>:* less than 1000 ppm.

*Fresh Air Exchanges:* 4 per hour.

*Flushing Interval:* 7-10 days.

*Harvest Stage:* Directly before the gills begin to deliquesce.

*Light:* Natural daylight or grow-light on a 12 hour cycle on/off cycle.

**Yield Potential:** Average commercial yields are 2-3 lbs/sq.ft. over a 4 week cropping period. Maximum yield potential has not yet been established.

**Moisture Content of Mushrooms:** 92-94% water; 6-8% dry matter.

**Nutritional Content:** 25.4 % protein (dry weight).

**Comments:** Like many other species in this genus, *Coprinus comatus* is a Thermotolerant mesophile that often appears in compost piles. This mushroom was first grown in quantity at the Dutch Mushroom Research Station using the same compost, casing and environmental parameters as for the cultivation of *Agaricus brunnescens*. The authors have grown this species on compost prepared for *Agaricus* and on straw alone, although fruitings appear more substantial on the former.

*Coprinus comatus* is edible and choice. However, the crops are difficult to keep because of the early onset of deliquescence. By submerging mushrooms in water, deliquescence is slowed and mushrooms remain in good condition for several days after picking.

Extracts from fresh specimens of this species has been shown to have antibiotic properties, similar to Those from *Lentinus edodes*.

**Genetic Characteristics:** Basidia tetrapolar (4-spored), forming haploid spores; heterothallic. Clamp connections present. See Chapter XV.

**For further information consult:**

P.J.C. Vedder 1978, "Modern Mushroom Growing", Educaboek, Culemborg, Netherlands. (English edition available from Swiss American Spawn Company, Inc., Madisonville, Texas).



**SPECIES:** *Flammulina velutipes* (Curt. ex Fr.) Sing.  
= *Collybia velutipes* (Curt. ex Fr.) Kumm.

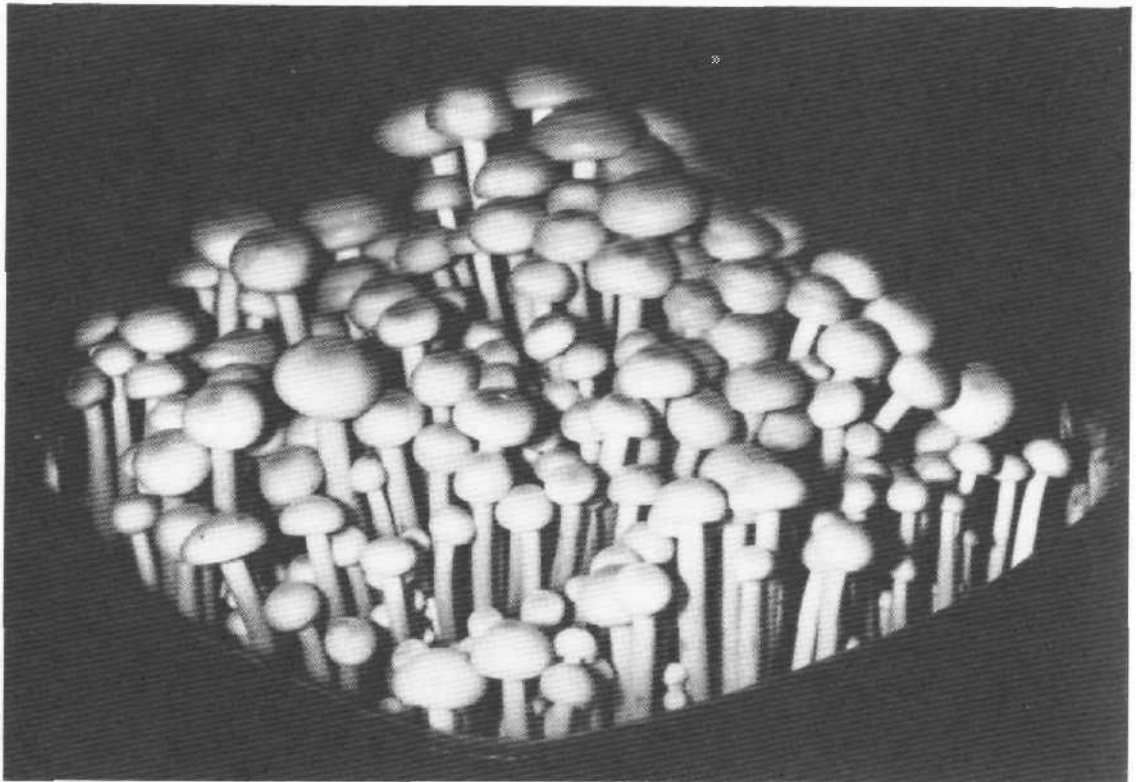

**Figure 151** *Flammulina velutipes* fruiting in tray.

**STRAINS:** Many wild and domesticated strains of *F. velutipes* are available from commercial and private stocks. (See Appendix). The Japanese have remained at the forefront of Enoke cultivation with two popular commercial strains, “Maruei” and “Ebios”.

**COMMON NAME:** Enoke; Winter Mushroom; or Velvet Stem.

**LATIN ROOT:** *Flammulina* comes from the latin word “flammeus” or flame colored for the yellowish orange to reddish orange color of the cap. The species epithet *velutipes* is the conjunction of two latin words, the adjective “velutinus” meaning covered with fine hairs and the noun “pes” or foot.

**GENERAL DESCRIPTION:** Caps typically small, reddish orange to reddish brown, at first hemispherical, soon plane. The cap margin is often irregularly shaped. The gills are yellowish tinged. In wild collections, the stem is densely fibrillose, velvety, short and tough. In culture, however, the stems are long and smooth. A partial veil is absent. Its spores are whitish in mass.

**NATURAL HABITAT:** Common across the North American continent and in other temperate to boreal regions of the world. Thriving on woody tissue, especially living trees and considered a cold weather mushroom.

## GROWTH PARAMETERS

**Mycelial Types:** Linear to cottony mycelia, sometimes aerial.

**Spawn Medium:** Sawdust/bran. One liter (1000 ml.) bottle of spawn inoculates 50-160 (800 ml.) containers. See Chapter III.

**Fruiting Substrate:** A 80-90% hardwood sawdust and 10-20% rice bran medium. Newly chipped sawdust holds moisture poorly and some Japanese growers age the sawdust for several years before using. Standard fruiting containers are quart mason jars or 800 ml. small mouthed plastic bottles. Some growers are currently experimenting with the cultivation of this species on bulk substrates in trays. Adjust moisture content of substrate to 58-60%.

**Method of Preparation:** See Chapter III for the preparation of sawdust/bran media. A 4:1 volumetric ratio of sawdust to bran (equivalent to a mass ratio of 10:1 sawdust to bran) is recommended. Sterilize for 1-2 hours at 250 °F. (15 psi).

### Spawn Run:

*Relative Humidity:* 90-100%.

*Substrate Temperature:* 72-77 °F.

*Duration:* 20-30 days using standard methods; 12-13 days using in vitro inoculation methods.

*CO<sub>2</sub>:* 5000-10,000 ppm.

*Fresh Air Exchanges:* 0 per hour.

**Type of Casing:** None required.

### Primordia Formation:

*Relative Humidity:* 85%.

*Air Temperature:* 50-55 °F.

*CO<sub>2</sub>:* less than 1000 ppm.

*Fresh Air Exchanges:* 4 per hour.

*Light:* None needed.

### Cropping:

*Relative Humidity:* 85%

*Air Temperature:* 50-55 °F.

*Duration:* 2-3 weeks.

*CO<sub>2</sub>:* less than 1000 ppm.

*Fresh Air Exchanges:* 4 per hour.

*Light:* Natural daylight or grow-light on a 12 hour cycle on/off cycle.

*Flushing Interval:* 10 days.

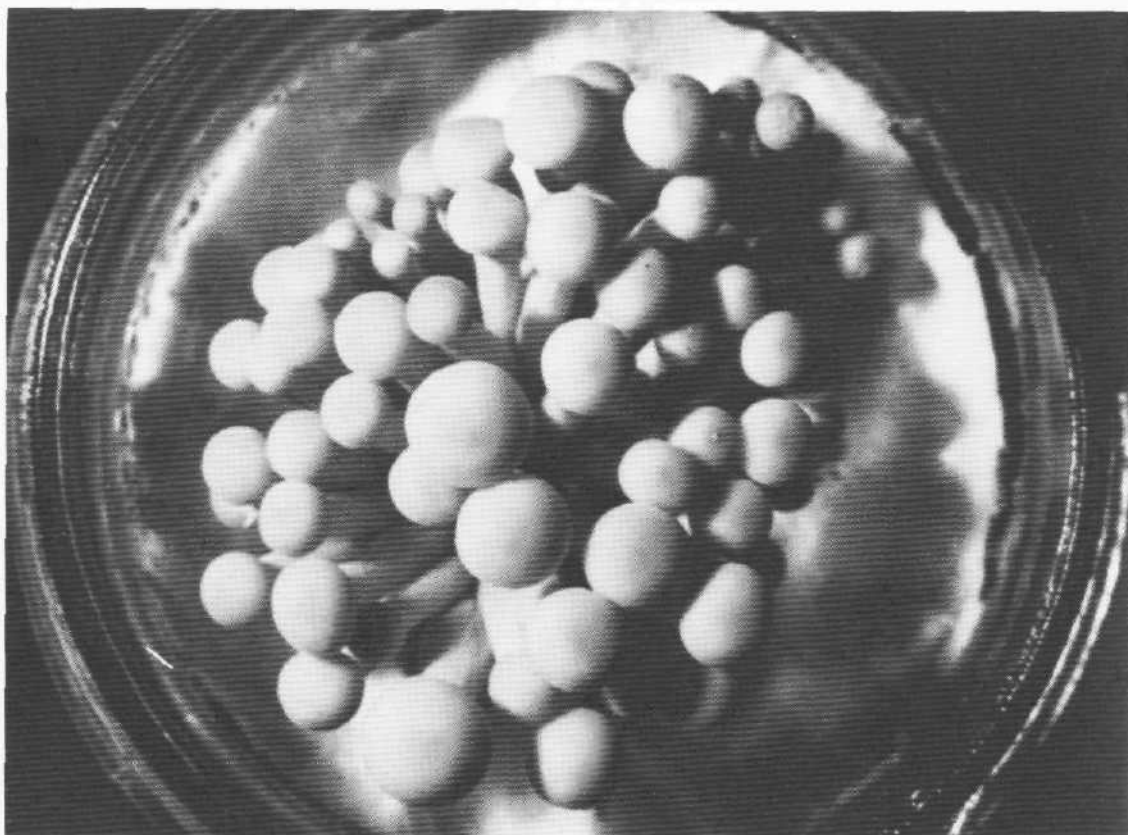

**Figure 152** Developing pinheads of *Flammulina velutipes*.

**Yield Potential:** Average commercial yields are 160-220 grams per 800 ml. bottle. Maximum yields are nearly 600 grams per 800 ml. bottle.

**Moisture Content of Mushrooms:** 92% water; 8% dry matter.

**Nutritional Content:** Reports vary from 18% to 31% protein (dry weight); 107 milligrams of niacin per 100 grams dry weight. F. Zadrazil (1979) found that colonization of straw by this species decreases its digestibility for use as fodder. This contrasts with the effects of *Pleurotus* and *Strophariarugoso-annulata* whose presence on straw markedly increases its digestibility. Like many wood degrading fungi, an anti-tumor antibiotic has been isolated from *F. velutipes* and is appropriately called flammulin.

**Comments:** *F. velutipes* tends to form mycelial "pellets" soon after colonizing a substrate. This phenomenon makes liquid culture techniques more difficult. Japanese researchers found that the addition of 5% corn starch and 2% malt to a liquid solution inhibits the formation of these troublesome pellets. Curiously, fruitings on sawdust/bran beds can be precipitated when pieces of a fruit-body are added to this solution. Shio et al. (1974) found that one could induce the early formation

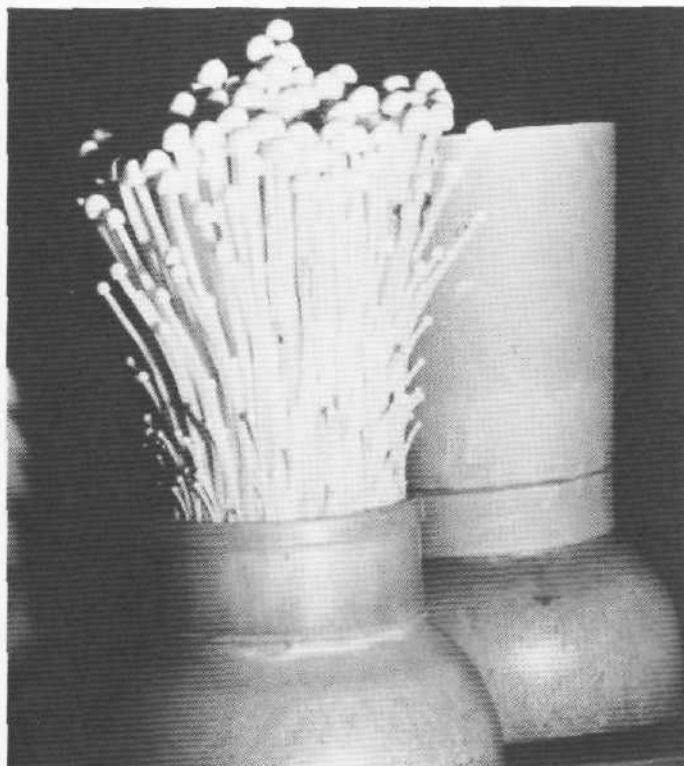

**Figure 153** *Flammulina velutipes* fruiting in plastic jar.

of fruitbodies with a technique whereby fresh pieces of *Flammulina velutipes* are mixed directly into liquid spawn and then introduced into the sawdust/bran medium. Not only was the fruiting process accelerated, the spawning period was cut in half and yield was nearly quadrupled over a year's time. Using this same technique with *Pleurotus ostreatus*, yields were increased over and above the norm by a factor of three. Total production in either case, equalled as much as  $\frac{1}{4}$  of the substrate on a dry weight basis. An analogous technique was developed by Urayama (1972) who discovered that cell-free extracts of fresh *F. velutipes* mushrooms introduced to cultures of distantly related species caused fruitbody formation.

**Genetic Characteristics:** Basidia Tetrapolar (4-spored), forming haploid spores; bifactorially heterothallic. Single spore isolates capable of producing sterile fruitbodies. Dikaryons are faster growing and characterized by clamp connections. Mycelium can produce oidia, self sectioning chains of cells with similar functions as spores. See Chapter XV.

**For further information consult:**

H. Tonomura, 1974. "*Flammulina velutipes*" in *The Biology and Cultivation of Edible Mushrooms*. Academic Press, New York.

SPECIES: *Lentinus edodes* (Berk.) Sing.

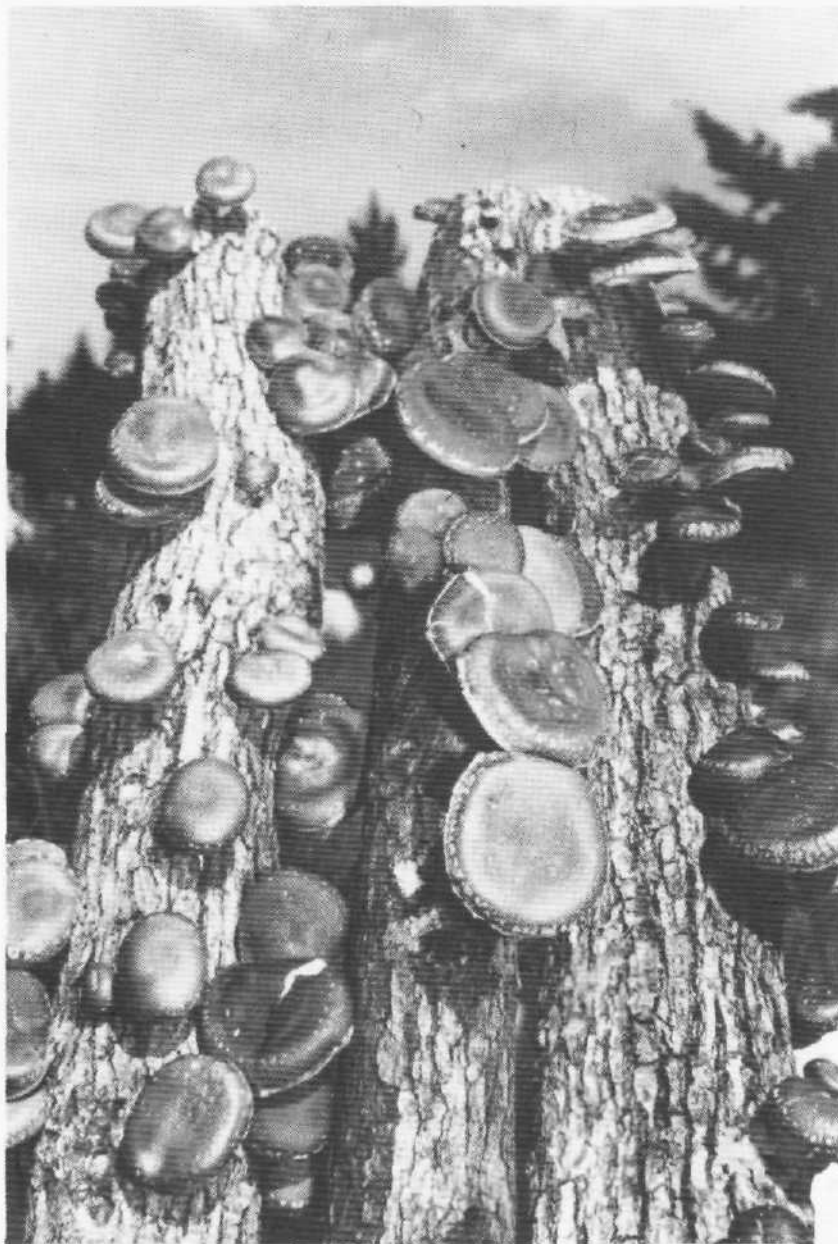

Figure 154 *Lentinus edodes*, the shiitake mushroom, fruiting on oak logs.

---

**STRAINS:** Numerous strains of *Lentinus edodes* are available from commercial and private stocks. The American Type Culture Collection, which sells cultures to educational organizations and research facilities, has stock cultures of several wild and domesticated strains. Strains are often distinguished by their preferences for fruiting in colder or warmer temperature zones.

**COMMON NAMES:** The Shiitake Mushroom; The Japanese Black Mushroom; and The Chinese Black Mushroom. (The name shiitake comes from the association of this mushroom to the shiia tree, a member of the genus *Pasania*).

**LATIN AND GREEK ROOTS:** *Lentinus* comes from "lentis" or lens-shaped for the form of the cap and *edodes* signifies the edibility of this species.

**GENERAL DESCRIPTION:** Cap pale to dark reddish brown, convex, becoming broadly convex to nearly plane in age. The cap margin is typically inrolled when young. The cap surface is covered with whitish veil remnants, especially along the margin. The flesh is firm, pliant, easily drying and reconstituting. The gills are whitish, close to crowded, often with serrated edges. The stem is centrally attached to the cap, short, very tough and adorned with scattered fibrillose remnants of the partial veil. Its spores are whitish in mass.

**NATURAL HABITAT:** A wood decomposer, typically saprophytic. *Lentinus* species are common on the dead tissue of deciduous trees, mainly Fagaceae (oak, chestnut, shiia [*Pasania*] and beech). In nature, they particularly prefer oaks. Fruiting in the fall, early winter and spring, this species is indigenous to Japan, China and other countries in the temperate zone of the Indo-China region.

## GROWTH PARAMETERS

**Mycelial Types:** Rhizomorphic to linear.

**Spawn Medium:** Pre-soaked wooden dowels or a 4:1 sawdust/bran mixture. See Chapter III.

**Fruiting Substrate and Method of Preparation:** Oak or alder logs, 4-6 inches in diameter, are sawed into 3 foot lengths. These logs should be cut in the spring or fall to maximize sap content and can be inoculated immediately. (Some growers prefer to season their logs in shaded, open air stacks for one month prior to inoculation). Before inoculating, logs should be cleaned of any lichen or fungal growths.

Alternative fruiting substrates include alder or oak sawdust and bran mixed 4:1 with a moisture content of 60% and sterilized at 15 psi for 1-1 1/2 hours. Fortified rye grass straw has also been used as a sterile fruiting medium. (See Chapter III).

### Spawn Run:

*Relative Humidity:* 60-75% for logs; 90% for sawdust.

*Substrate Temperature:* Fast growth at 77°F. (Temperatures above 95°F. and below 41°F. stop mycelial growth).

*Duration:* 6-12 months for cut logs; 30-60 days for sawdust blocks.

*CO<sub>2</sub>:* None established; no controls needed using these methods.

*Fresh Air Exchanges:* Stacks in open air sufficient. (Recent innovations show that logs stacked in a vertical configuration and covered with straw and plastic to maintain even temperatures result in faster spawn running in an outdoor environment. Within a controlled greenhouse, the logs need not be covered. The contact between the log surfaces should be minimized to prevent competitor molds and lichens from forming).

*pH Optima:* 5-6.

*Light:* None required.

**Type of Casing:** None needed.

**Pinhead Initiation:**

*Initiation Technique:* Submerge logs and blocks in cold water for 24-72 hours.

*Relative Humidity:* 95%.

*Air Temperature:* 59-68 °F.

*Duration:* 7-14 days after soaking.

*CO<sub>2</sub>:* Not applicable.

*Fresh Air Exchanges:* If within a greenhouse, 2-4 per hour.

*Light:* Ambient natural light or optimally 10 lux in the 370-420 nanometer range.

**Cropping:**

*Relative Humidity:* 85-90%.

*Air Temperature:* 59-68 °F.

*CO<sub>2</sub>:* less than 1000 ppm.

*Fresh Air Exchanges:* 2-4 per hour or sufficient to meet CO<sub>2</sub> and/or cooling requirements.

*Duration:* 3-5 years on oak logs; 2-3 years on alder.

*Harvest Stage:* Directly before the incurved margin straightens and the cap expands to plane.

*Flushing Interval:* Outdoor methods generate 2 flushes per year (fall and spring); indoor methods can produce up to 4 flushes depending on the soaking/initiation schedule.

*Light:* Same as above.

**Yield Potential:** Average commercial yields are 2-3 lbs (fresh weight) of mushrooms per log.

**Moisture Content of Mushrooms:** 85% water; 15% dry matter.

**Nutritional Content:** 10.0-17.5% crude protein (dry weight) and 55 milligrams of niacin per 100 grams dry weight.

Comments: Compounds in this mushroom have anti-cholesterol effects. Chihara (1979) reported that lentinan, a water soluble polysaccharide in *L. edodes*, was "found to almost completely regress the solid type tumors of sarcoma-180 and several kind (sic) of tumors. . .". The work of others (Cochran, 1978; Tokita et al., 1972; Tokuda and Kaneda, 1979) have similarly described the beneficial properties of this fungus. (See Appendix III).

Although the standard method of cultivation involves oak logs, recent experiments employing

sawdust or rye grass based "synthetic" mixtures have proved that *Lentinus edodes* can be grown on a variety of substrates. In a recent article, Han et alia (1981) report the results of growth experiments with shiitake mini-logs composed of 90% broadleaf sawdust, 10% rice bran and 0.2%  $\text{CaCO}_3$ . Supplements that increased mycelial growth more than rice bran were yeast powder (2.0%), soybean meal (5.0%), milk powder (2.0%) and molasses (1.5%). The fastest mycelial growth occurred when the moisture content of the logs was balanced to 50-60%. In tests on fruiting and yield the following data were compiled:

Once mycelial growth is complete, highest yields were achieved if the vegetative cycle was prolonged 4-12 weeks, with the maximum yield at 12 weeks.

At pin initiation, water bath periods of 48-72 hours increased the moisture content of the logs by 5-15% and yields by 50%.

Cooling the logs for eight days at 60-62°F. following 48 hours of soaking gave the highest yields.

Using 0.1 % N hydrochloride to adjust the pH of the water bath from 4.5-7.0, a pH of 5.0 produced the most primordia and mature mushrooms.

At a light intensity of 550 lux, yields were highest.

The addition of the hormones NAA (5ppm), gibberellin (10ppm), ethylene chlorohydrin (2000x) and colchicine (8000x) as well as yeast powder (0.1 %) to the water bath increased yields.

Nevertheless, the traditional log method remains the most commercially feasible at this time and the one best suited to home cultivation.

**Genetic Characteristics:** Basidia tetrapolar, forming four haploid spores; heterothallic. Dikaryons with clamp connections. See Chapter XV.

**For more information consult:**

H. Akiyama et al., 1974. "The Cultivation of *Shii-ta-ke* in a Short Period". Mushroom Science IX, pp. 423-433.

T. Ito, 1978. "Cultivation of *Lentinus edodes*" in The Biology and Cultivation of Edible Mushrooms Ed. by ST. Chang, pp. 461-473.

R. Kerrigan, 1982. "Is Shiitake Farming for You?" Far West Fungi, Santa Cruz.

Y.H. Han, W.T. Veng and S. Cheng, 1981. "Physiology and Ecology of *Lentinus edodes* (Berk.) Sing," Mushroom Science XI, Melbourne.



**SPECIES:** *Lepista nuda* (Bull. ex Fr.) Cooke  
= *Clitocybe nuda* (Fr.) Bigelow and Smith  
= *Tricholoma nudum* (Fr.) Kummer

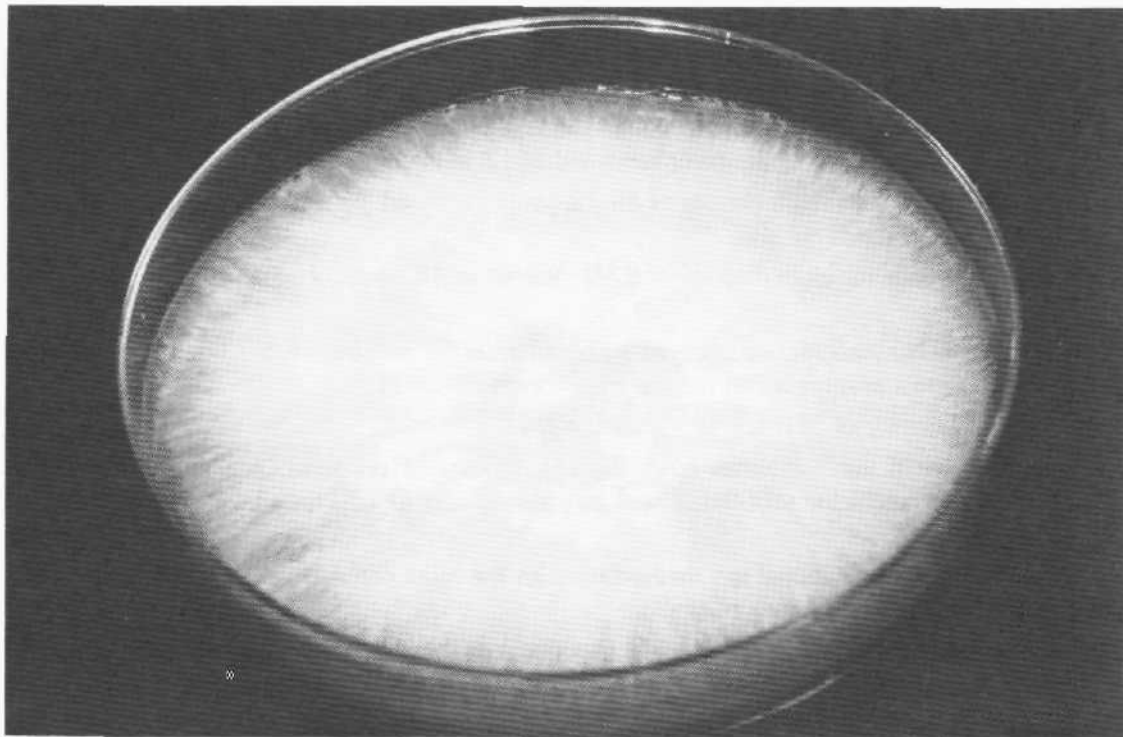

**Figure 155** Mycelium of *Lepista nuda*.

**STRAINS:** Available from commercial and private stocks. The American Type Culture Collection has several strains. Although few spawn companies sell strains of *L. nuda*, tissue and spore cultures are easily obtained from wild specimens. Nevertheless, there are a limited number of productive strains currently in circulation.

**COMMON NAME:** The Blewit.

**LATIN AND GREEK ROOTS:** *Lepista* comes from the greek “lepis” which means scale. On the other hand, the species epithet *nuda* comes from “nudus” or naked. The name *Lepista nuda* constitutes a contradiction of terms, literally translating as the scaly smooth mushroom.

**GENERAL DESCRIPTION:** Cap typically violet when fresh, becoming buff brown in drying; smooth, without hairs; dry; convex or broadly convex to plane in age. The cap margin is inrolled or incurved when young and simply decurved at maturity. The gills are a pale violet color, sometimes developing brownish hues in age and are adnexed or ascending in their attachment to the stem. The stem is equal overall but bulbous at the base and covered with fine fibrils over much of its surface.

---

Fruitbodies can be moderately large when mature. A partial veil is absent. The spore deposit is pale pinkish Tan.

**NATURAL HABITAT:** Commonly occurring in the summer to late fall across much of the temperate regions of North America and Europe. This species is found in and around decomposing piles of sawdust, in conifer duff, amongst leaves and in mature compost piles.

## GROWTH PARAMETERS

**Mycelial Types:** Linear to cottony and usually with purplish to violet hues. (See Color Photo 3).

**Spawn Medium:** A 4:1 sawdust/bran mixture or rye grain spawn. See Chapter III.

**Fruiting Substrates:** Horse manure/straw compost mixed with 10% fresh straw at spawning; leaf mulch/sawdust mixtures.

### Spawn Run:

*Relative Humidity:* 90 + %.

*Substrate Temperature:* Fastest growth at 70-75°F. Temperature maxima and minima: 40°F. and 86°F. respectively.

*Duration:* 25-60 days for complete colonization.

*CO<sub>2</sub>:* 5000-10,000 ppm.

*Fresh Air Exchanges:* 0 per hour.

*Light:* Incubation in total darkness.

**Type of Casing:** Standard peat based casing. An option is the addition of shredded leaf material and activated charcoal to 10% of total mass. Balance to a pH of 7.0.

### Pinhead Initiation:

*Relative Humidity:* 95%.

*Air Temperature:* 55-65°F.

*Duration:* 7-14 days.

*CO<sub>2</sub>:* less than 1000 ppm

*Fresh Air Exchanges:* 2-4 per hour.

*Light:* Ambient natural light or optimally 10 lux in the 370-420 nanometer range. (Light requirements have not yet been established for this species, and until that time, light stimulation should be presumed as a prerequisite for fruiting.)

### Cropping:

*Relative Humidity:* 85-90%.

*Air Temperature:* 55-65°F.

*Duration:* 24-52 weeks.

*CO<sub>2</sub>:* less than 1000 ppm.

*Fresh Air Exchanges:* 2-4 per hour.

---

*Harvest Stage:* While the mushroom caps remain convex.

*Flushing Interval:* 10-14 days.

*Light:* Same as above.

**Yield Potential:** Data very limited. Yields of one and a quarter pounds per square foot in 14 weeks have been reported by Visscher (1981). (Recent studies show that yields can be increased substantially, although no maxima have yet been established.)

**Moisture Content of Mushrooms:** 88-90% water; 10-12% dry matter.

**Nutritional Content:** No data available.

**Comments:** Several contradictions about the fruiting requirements for this species are apparent. Although Wright and Hayes (1979) reported that immature horse manure/straw composts supported the most vigorous mycelial growth, the work of previous researchers indicates that the best fruitings occurred on "spent" compost that has been colonized for a year or more. Fruitbodies also form on spawned leaf mulch mixed with sawdust. The fruiting mechanism may, in part, be controlled by bacterial flora associated with leaf mulch and the decomposition process.

Singer (1963) reported that mycelium implanted in beds of horse manure/straw compost for 7-14 months produced mushrooms directly after the appearance of rhizomorphs. J. Garbaye et al. (1979) published data indicating that the supplementation of natural patches with a NPKCa mineral fertilization induced large fruitings of *L. nuda* as well as *Boletus edulis* and *Lepiota rachodes*, two unrelated species of culinary distinction.

Alexander Smith (1980) remarks that this mushroom should not be eaten raw, but only after cooking. European books have reported that this mushroom contains thermobile hemolysin, a compound that degenerates red blood cells. Although this mushroom has been responsible for scattered poisonings when quantities have been eaten, the effects have been relatively minor and the toxin is easily destroyed by cooking or parboiling. *Lepista nuda* is, however, a mushroom with many positive attributes. Its striking color, firm texture and good taste recommend this species as one of high culinary appeal.

Some commercial production of *L. nuda* is ongoing in Europe. Nevertheless, this mushroom is not, as of yet, a species with yields substantial enough to warrant commercial production in this country. It is a mushroom more suited to the interests of home cultivators and natural culture techniques.

**Genetic Characteristics:** Basidia tetrapolar, forming four haploid spores; heterothallic. Dikaryons with clamp connections. See Chapter XV.

For more information consult:

S.H. Wright and W.A. Hayes, 1979. "Nutrition and Fruitbody Formation of *Lepista Nuda* (Bull. ex Fr.) Cooke", pp. 873-884 in Mushroom Science X, Part I. Bordeaux.

J. Garbaye et alia, 1979. "Production De Champignons Comestibles En Foret Par Fertilisation Minerale-Premiers Resultats Sur *Rhodopaxillus Nudus*". pp.81 1 -81 6 in Mushroom Science X, Part I. Bordeaux.

M. Vaandrager and H.R. Visscher, 1981. *Experiments on the Cultivation of Lepista Nuda, the Wood Blewit*", pp. 749-759 in Mushroom Science XI, Australia.

---

**SPECIES:** *Panaeolus cyanescens* Berkeley and Broome  
= *Copelandia cyanescens* (Berk. & Br.) Sing.



Figure 156 *Panaeolus cyanescens* fruiting on cased straw.

**STRAINS:** Hawaiian.  
Mexican.

**COMMON NAME:** Pan cyan.

**GREEK ROOT:** *Panaeolus* is Greek for "all variegated", in reference to the spotted appearance of the gills. The species name *cyaneus* comes from "cyaneus" or blue for the color the flesh becomes upon bruising.

**GENERAL DESCRIPTION:** Cap 15-40 mm. broad. Hemispheric to *campanulate* to convex or broadly convex at maturity. The margin is initially shortly translucent striate when wet, opaque when dry. The cap is light brown at first, becoming pallid grey in drying, eventually pallid to white, often covered with spores. The gills are adnexed in their attachment, close, thin, with two or three tiers of intermediate gills and mottled grayish black at with spore maturity. The stem is 85-120 long x 15-30 mm. thick and equal to bulbous at the base, tubular, often grayish towards the apex, pale yellowish overall, and flesh colored to light brown towards the base. The flesh readily turns bluish where bruised. A partial veil is absent. Its spores are dark violet-black.

**NATURAL HABITAT:** Scattered to numerous on dung, in well manured grounds, grassy areas, meadows, or pastures. Known from Hawaii and Mexico. Two other *Panaeoli*, close to *P. cyaneus* macroscopically and microscopically, grow in western Washington and in Florida.

## GROWTH PARAMETERS

**Mycelial Types:** Linear to cottony mycelia; white to off-white, sometimes bruising bluish where injured.

**Spawn Medium:** Rye grain. See Chapter III.

**Fruiting substrate:** Pasteurized wheat straw; horse manure/straw compost.

**Method of Preparation:** Chopped wheat straw pasteurized in a hot water bath at 160° for 20-30 minutes, cooled and spawned or horse manure/straw compost prepared according methods outlined in Chapter V.

**Spawn Run:**

*Relative Humidity:* 90 + %.

*Substrate Temperature:* 79-84° F.

*Duration:* 7-12 days.

*CO<sub>2</sub>:* 10,000 ppm or higher.

*Fresh Air Exchanges:* 0 per hour.

**Type of Casing:** Standard peat based casing whose preparation is described in Chapter VIII. Layer to a depth of ½-1 inch.

**Post Casing/Pre-pinning:**

*Relative Humidity:* 90 + %.

*Substrate Temperature:* 79-84° F.

---

*CO*<sub>2</sub>: 10,000 ppm or above.

*Fresh Air Exchanges*: 0 per hour.

*Light*: Incubation in darkness.

**Primordia Formation:**

*Relative Humidity*: 95 + %.

*Air Temperature*: 75-80 ° F.

*CO*<sub>2</sub>: 5,000 ppm or below.

*Fresh Air Exchanges*: 2 per hour.

*Light requirements*: Diffuse natural or fluorescent grow-lights.

**Cropping:**

*Relative Humidity*: 85-92%.

*Air Temperature*: 75-80 ° F.

*CO*<sub>2</sub>: 5,000 ppm or below.

*Fresh Air Exchanges*: 2 per hour.

*Harvest Stage*: When the caps are convex.

*Flushing Interval*: 5-7 days.

*Light*: Diffuse natural or grow-lights.

**Yield Potential**: Not yet established.

**Moisture Content**: 90-92% water; 8-10% dry matter.

**Comments**: This rapidly growing species fruits readily on pasteurized straw provided a thin layer of casing is applied (½ inch). No more than one week passes from the time of casing to the first flush. Although the fruitbodies are small, the flushes are typically abundant. The degree of bluing seems to vary with The strain and substrate.

---

**SPECIES:** *Panaeolus subbalteatus* Berkeley and Broome  
= *Panaeolus venenosus* Murrill



**Figure 157** *Panaeolus subbalteatus* fruiting outdoors on horse manure-wood chip compost.

**STRAINS:** Fruiting strains are easily obtained from wild specimens.

**COMMON NAME:** The Belted Cap Panaeolus.

**GREEK ROOT:** *Panaeolus* is Greek for "all variegated" in reference to the spotted appearance of the gills. The species name *subbalteatus* comes from the conjunction of the prefix "sub-" meaning almost or somewhat and "balteatus" or belt-like, for the characteristic color zonation that forms along the margin of the cap in drying.

---

**GENERAL DESCRIPTION:** Cap 35-50 mm. broad at maturity. The cap is convex to campanulate, then broadly convex and finally expanding to nearly plane with a broad umbo. The color is cinnamon brown to orangish cinnamon brown, fading to tan in drying with a dark brown encircling zone along the cap margin. The gills are attached to the stem, broader at the center and with three tiers of intermediate gills inserted. The gill color is brownish and spotted, with the edges remaining whitish, becoming blackish overall from spore maturity. The stem is 50-60 mm. long by 4 mm. thick at maturity and is brittle, hollow, fibrous, and enlarges towards the base. The color is reddish toned beneath a fine sheath of minute whitish fibrils, darkening downwards or when touched. The stem base often bruises bluish. On the cap, bluing is rarely seen.

**NATURAL HABITAT:** Scattered to numerous on stable leavings from horses; in horse dung; or in well manured grounds. This species is widely distributed across the North American continent and throughout temperate regions of the world.

## GROWTH PARAMETERS

**Mycelial Type:** Cottony mycelia noted; whitish to off-white in color.

**Spawn Medium:** Rye grain.

**Fruiting Substrate:** Horse manure compost, pasteurized wheat straw.

**Method of Preparation:** Horse manure/straw compost or pasteurized wheat straw prepared according to methods outlined in Chapters V & VI respectively.

**Spawn Run:**

*Relative Humidity:* 90 + %.

*Substrate Temperature:* 80-86 °F.

*Duration:* 7-12 days.

*CO<sub>2</sub>:* 10,000 ppm or higher.

*Fresh Air Exchanges:* 0 per hour.

**Type of Casing:** Casing optional. If used, make up a standard peat based casing whose preparation is described in Chapter VIII. Layer to a depth of ½ to 1 inch.

**Post Casing/Pre-pinning:**

*Relative Humidity:* 90%.

*Substrate Temperature:* 80-86 °F.

*CO<sub>2</sub>:* 10,000 ppm or above.

*Fresh Air Exchanges:* 0 per hour.

*Light:* Incubate in darkness.

**Primordia Formation:**

*Relative Humidity:* 95 + %.

*Air Temperature:* 75-80 °F.

*CO<sub>2</sub>:* 5,000 ppm or below.



*Fresh Air Exchanges:* 2 per hour.

*Light:* Diffuse natural or grow-lights.

### **Cropping**

*Relative Humidity:* 85-92%.

*Air Temperature:* 75-80 °F.

*CO<sub>2</sub>:* 5,000 ppm or below.

*Fresh Air Exchanges:* 2 per hour.

*Harvest Stage:* When the caps have expanded to nearly plane.

*Light:* Diffuse natural or grow-lights.

**Yield Potential:** Not yet established.

**Moisture Content:** 90-92% water; 8-10% dry matter.

**Comments:** *Panaeolus subbalteatus* is a fast running and an early fruiting mushroom that easily grows in controlled environments. Possessing low levels of psilocybin and/or psitocin, the fruit-bodies are small compared to other cultivated mushrooms. Hence, it has not been as popular with home cultivators as for instance, *Psilocybe cubensis*.

Given the fact that *Panaeolus cyanescens* fruits well on pasteurized wheat straw, *Panaeolus subbalteatus* is likely to fruit on that substrate as well. Pollock (1977) fruited this species on cased crimped oat spawn. Undoubtedly, *Panaeolus subbalteatus* can be grown on a wide variety of substrates.

Short term "natural culture" of this mushroom is also possible although yields are much lower than those attained in a controlled indoor growing environment. Horse manure/straw compost arranged in outdoor beds can be inoculated with mycelium from wild patches or grain spawn can be used.

*Panaeolus subbalteatus* is considered a "weed mushroom" by commercial *Agaricus* growers and its presence suggests under-composting and/or excessive moisture. This species once had the reputation, albeit undeserved, of being poisonous—thus the synonym *Panaeolus venenosus*.

**SPECIES:** *Pleurotus ostreatus* (Jacq. ex Fr.) Kummcr



**Figure 158** Fully mature *Pleurotus ostreatus* mushrooms fruiting on straw.

**STRAINS:** Strains of *Pleurotus ostreatus* are available from commercial and private stocks. The American Type Culture Collection, which sells cultures to educational organizations and research facilities, has stock cultures of several wild and domesticated strains. Somycel's-3004 is the standard strain used by the European *Pleurotus* industry and is synonymous with ATCC's-38546.

**COMMON NAME:** The Oyster Mushroom.

**LATIN AND GREEK ROOTS:** *Pleurotus* comes from the greek "pleuro" which means formed laterally or in a sideways position, referring to the lateral position of the stem relative to the cap. The species epithet *ostreatus* refers to its oyster shell-like appearance and color.

**GENERAL DESCRIPTION:** Cap tongue shaped, maturing to a shell shaped form, 50-150 mm. in diameter; whitish to gray to blue gray overall. (Color is a light determined factor in this species). The flesh is thin and white. The margin is even and occasionally wavy. The gills are white, decurrent

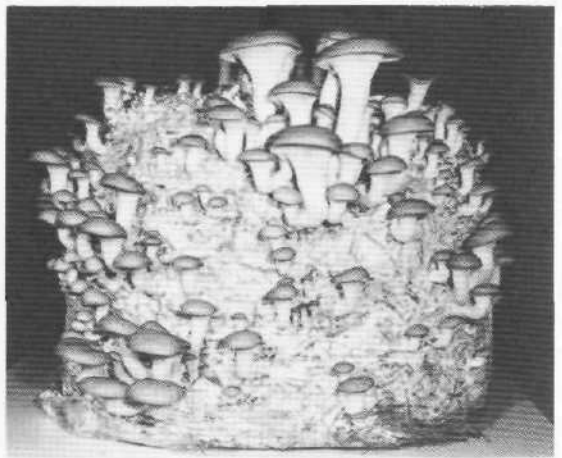
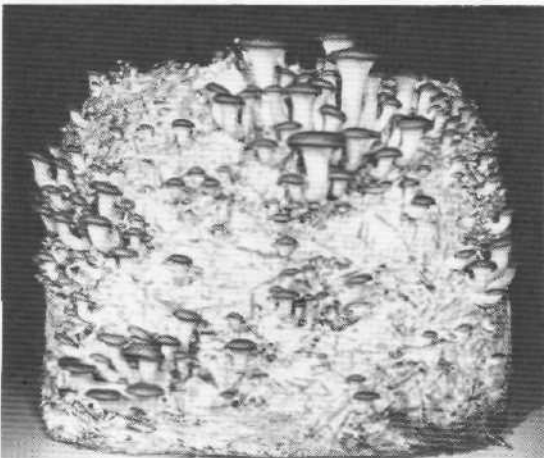
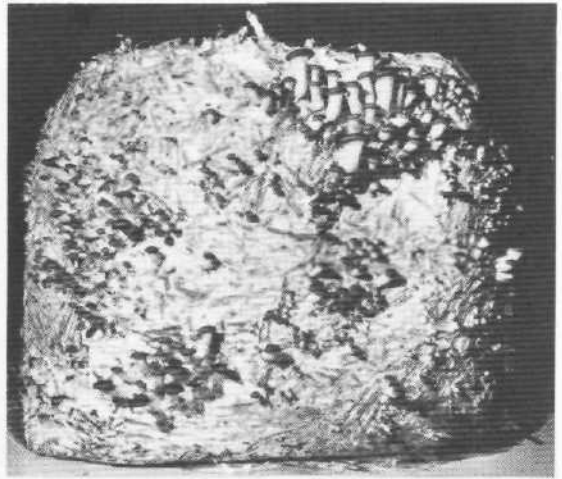
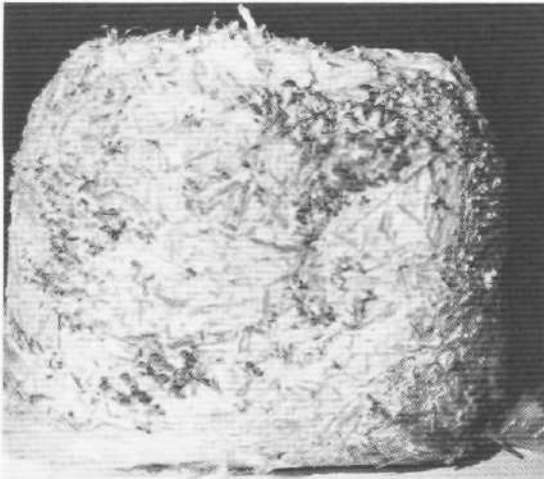

**Figures 159-162** Four day developmental sequence of *Pleurotus ostreatus* fruiting on wheat straw.

and broadly spaced. The stem is attached in an off-centered fashion and is short at first and absent in age. Its spores are whitish to lilac gray in mass.

**NATURAL HABITAT:** A wood decomposing, saprophytic or parasitic fungus. *Pleurotus ostreatus* grows abundantly on standing and fallen alder, cottonwood and maple. This species is especially numerous in river valleys and fruits in the fall, early winter and spring across much of temperate North America.

## GROWTH PARAMETERS

**Mycelial Types:** Fast growing rhizomorphic to linear mycelia noted. Color is typically whitish.

**Spawn Medium:** Rye grain. See Chapters III.

**Fruiting Substrate and Method of Preparation:** Cereal straw (normally wheat) balanced to a 75% moisture content. The straw, chopped or whole, is pasteurized by submerging in a 160°F. water bath for 30-45 minutes. An *alternative* method utilizes live steam pasteurization at 140°F. for 6 hours. In Japan, *Pleurotus* is grown on a mixture of hardwood sawdust and bran (4 parts to 1, 65% moisture and a pH of 6.8-7.0). This mixture is sterilized for 1-2 hours at 15 psi. Being a primary decomposer, *Pleurotus* grows on a wide *variety* of cellulosic wastes.

### Spawn Run:

*Relative Humidity:* 90-100%.

*Substrate Temperature:* Fastest growth at 78-84°F. Thermal death occurs if mycelium is held above 104°F. for 48 hours.

*Duration:* 10-14 days for complete colonization.

*CO<sub>2</sub>:* 20,000 ppm or 20% CO<sub>2</sub> by volume. (Growth is stimulated up to 28,000 ppm).

*Fresh Air Exchanges:* 0 per hour.

*Light:* Incubation in total darkness.

**Type of Casing:** None needed.

### Pinhead Initiation:

*Relative Humidity:* 95%.

*Air Temperature:* 55-60°F.

*Duration:* 7-14 days.

*CO<sub>2</sub>:* less than 600 ppm.

*Fresh Air Exchanges:* 4 per hour.

*Light:* Phototropic, most responsive to an exposure of 2,000 lux/hour for 12 hours/day. Grow-lux type fluorescent lighting is recommended. Diffuse natural light is sufficient.

*Watering:* Regular misting once to twice daily until fruitbodies are 30-40% of harvest size and then water as needed to prevent caps from cracking.

### Cropping:

*Relative Humidity:* 85-92%.

*Air Temperature:* 60-64°F.

*Duration:* 5-7 weeks.

*CO<sub>2</sub>:* less than 600 ppm.

*Fresh Air Exchanges:* 4-6 per hour or sufficient to meet CO<sub>2</sub> and/or cooling requirements.

*Harvest Stage:* Directly before incurved margin elevates to plane.

*Flushing Interval:* 10 days.

*Light:* Same as above.

*Watering:* Regular misting to prevent caps from cracking and to keep resting pinheads viable.

**Yield Potential:** Average commercial yields are 1 kilogram fresh weight of mushrooms per kilogram of dry weight of straw substrate.

**Moisture Content of Mushrooms:** 91 % water; 9% dry matter.

**Nutritional Content:** Crude protein has been reported at 30.4 % of dry weight and 109 milligrams of niacin per 100 grams dry weight.

**Comments:** Biologically, *Pleurotus ostreatus* efficiently utilizes its substrate. Its ability to fruit on a single component substrate, to permeate the straw rapidly while tolerating high carbon dioxide levels and to produce abundant crops within a short time period, make *Pleurotus* ideal for home cultivation.

Of concern to cultivators growing in enclosed rooms is the abundant spore load generated by this species. *Pleurotus* spores cause allergic reactions amongst some workers and mycophagists. Sporeless strains are therefore desirable and are the object of current research. Eger (1974) noted the possibility that heavy spore concentrations from *Pleurotus* farms could infect surrounding woodlands.

*Pleurotus ostreatus* var. *Florida*, a warmth loving relative, is also cultivated in Europe (Hungary) and shares many of the growth properties of *Pleurotus ostreatus*.

**Genetic Characteristics:** Basidia tetrapolar, producing 4 haploid spores; *heterothallic*. Clamp connections present. See Chapter XV.

**For more information consult:**

F. Zadrazil, 1974. "The Ecology and Industrial Production of *Pleurotus ostreatus*, *Pleurotus Florida*, *Pleurotus cornucopiae*, and *Pleurotus eryngii*" in Mushroom Science IX (Part I), The Mushroom Research Institute, Japan.

**SPECIES:** *Pleurotus ostreatus* (Jacq. ex Fr.) Kummer (Florida variety)

= *Pleurotus ostreatus* var. *florida* nom. prov. Eger

= *Pleurotus floridanus* Singer

**STRAINS:** Most strains of this mushroom originate from wild specimens cultivated in 1958 by S.S. Block of Gainesville, Florida. Eger compared the Florida strains with *Pleurotus ostreatus* from Michigan (supplied by Alexander Smith) and found them to be identical in form, taste, color and odor. Spore size and shape are also the same. Monokaryons arising from single spore germinations are completely cross fertile, suggesting that these two mushrooms are not separate species, but different strains within the same species.

The American Type Culture Collection, which sells cultures to educational organizations and research facilities, lists this mushroom under *Pleurotus ostreatus* as number #38538. This strain is Block's original. Eger returned to Florida with San Antonio in 1977 and recollected four more strains of *Pleurotus*, three of which were deposited with ATCC. They are respectively: F1 = ATCC #38539; F2 = #38540; F4 = #38541.

The Florida *Pleurotus* is available as commercial spawn from Somycel as #3025. The Swiss American Spawn Company sells a "low spore load" strain called P-3.

**COMMON NAME:** Pleurotus Florida. The Florida Pleurotus.

**LATIN AND GREEK ROOTS:** *Pleurotus* comes from the Greek "pleuro" which means formed laterally or in a sideways position, referring to the lateral position of the stem relative to the cap. The epithet Florida obviously refers to the locality where this mushroom was first collected.

**GENERAL DESCRIPTION:** Cap tongue shaped, maturing to a shell shaped form, 50-100 mm. in diameter; whitish to gray to pale yellow brown. (Color is a light and temperature determined factor in this species). The flesh is thin and white. The margin is even and occasionally wavy, The gills are white, decurrent and broadly spaced. The stem is attached in an off-centered fashion and is short at first and absent in age. Its spores are whitish to lilac gray in mass.

**NATURAL HABITAT:** A wood decomposing, saprophytic or parasitic fungus. *Pleurotus ostreatus* grows abundantly on standing and fallen alder, cottonwood and maple. This species is especially numerous in river valleys and fruits in the fall, early winter and spring in subtropical environs.

## GROWTH PARAMETERS

**Mycelial Types:** Fast growing rhizomorphic to linear mycelia. Its color is typically whitish.

**Standard Spawn Medium:** Rye grain. See Chapter III.

**Fruiting Substrate and Method of Preparation:** Cereal straw (normally wheat) balanced to a 75% moisture content. The straw, chopped or whole, is pasteurized by submerging in a 160°F.

water bath for **20-30** minutes. An alternative method utilizes live steam pasteurization at 140°F. for 6 hours.

In Japan, *Pleurotus* is grown on a mixture of hardwood sawdust and bran (4 parts to 1, 65% moisture and a pH of 6.8-7.0). This mixture is sterilized for 1 hour at 15 psi. Being a primary decomposer, *Pleurotus* grows on a wide variety of wastes high in cellulose.

**Spawn Run:**

*Relative Humidity:* 90-100%.

*Substrate Temperature:* Fastest growth at 82-86°F. Thermal death **occurs** if mycelium is held above 104°F. for 72 hours.

*Duration:* 10-14 days for complete colonization.

*CO<sub>2</sub>:* **20,000** ppm or **20%** CO<sub>2</sub> by volume. (Growth is stimulated up to **28,000** ppm).

*Fresh Air Exchanges:* 0 per hour.

*Light:* Incubation in total darkness.

**Type of Casing:** None needed.

**Pinhead Initiation:**

*Relative Humidity:* 95%.

*Air Temperature:* 72-77°F.

*Duration:* 7-14 days.

*CO<sub>2</sub>:* less than 600 ppm

*Fresh Air Exchanges:* 4 per hour.

*Light:* Positive phototropism has been firmly established. **2,000** lux/hours for 12 hours/day is most stimulatory. Grow-lux type fluorescent lighting is recommended. Diffuse natural light is sufficient.

*Watering:* Regular misting (once to twice daily) of the substrate until the fruitbodies **are 30-40%** of harvest **size**.

**Cropping:**

*Relative Humidity:* 85-92%.

*Air Temperature:* 72-77°F.

*Duration:* **4-5 weeks**.

*CO<sub>2</sub>:* less than 600 ppm.

*Fresh Air Exchanges:* 4-6 per hour or sufficient to meet CO<sub>2</sub> and/or cooling requirements.

*Harvest Stage:* Directly before incurved margin expands to plane.

*Flushing Intervals:* 10 days.

*Light:* Same as above.

*Watering:* Misting recommended to prevent cracking of caps and to prevent resting primordia from **drying**.

**Yield Potential:** Average commercial yields for *Pleurotus ostreatus* var. Florida are 1 kilogram

---

fresh weight of mushrooms per kilogram of dry weight of straw substrate. *Pleurotus ostreatus* var. *florida* produces more mushrooms within a shorter period of time while attaining a similar total yield per dry pound of substrate than does *Pleurotus ostreatus*.

**Moisture Content of Mushrooms:** 91 % water; 9% dry matter.

**Nutritional Content:** Crude protein has been reported at 30.4% of dry weight and 109 milligrams of niacin per 100 grams dry weight.

**Comments:** The Floridan *Pleurotus ostreatus*, a warmth loving variety, is popular with growers in Europe (Hungary, France and Germany) and shares many of the growth characteristics of *Pleurotus ostreatus*. Its preference for warmer climates recommends this species for cultivation during the late spring through early fall whereas *P. ostreatus* is ideal for winter cultivation.

This mushroom, like its close cousin *P. ostreatus*, is perfect for the home cultivator. But, the Floridan *Pleurotus ostreatus* has a distinct advantage over *P. ostreatus* in that a "cold shock" is not needed for pinhead formation and the period from initiation to first flush is only 10 days compared to 20 days for *P. ostreatus*. Its ability to fruit on a singular substrate, to permeate the straw rapidly while tolerating high CO<sub>2</sub> levels and to produce abundant crops within a short time frame, makes *Pleurotus* an excellent species for small scale cultivation.

The taxonomy of this "species" is unsettled and contradictory. Dr. Rolf Singer places *P. floridanus* in the Section *Lentodiellum* whose species are characterized by deeply rooted metuloid pleurocystidia (sterile surface cells on the gill having incrustations) and have mycelia that do not sclerotize. On the other hand, he assigns *Pleurotus ostreatus* to the type section *Pleurotus* which lacks metuloid pleurocystidia and has hyphae that undergoes sclerotization. Since monokaryons from single spores are compatible between these two mushrooms, and because sporulating fruit-bodies form as a result of their mating, it seems clear that these two mushrooms are one species sharing a common genetic heritage.

Of concern to cultivators is the abundant spore load produced by this mushroom, most noticeable within an enclosed growing environment. Some people suffer allergic reactions when coming into contact with *Pleurotus* spores. A small fraction of mycophagists are unable to eat *P. ostreatus* and allies without stomach upset. Hence, when eating these mushrooms for the first time, small portions are recommended,

**Genetic Characteristics:** Basidia tetrapolar, producing 4 haploid spores; heterothallic. Clamp connections present. See Chapter XV.

For more information consult:

F. Zadrazil, 1974. "The Ecology and Industrial Production of *Pleurotus ostreatus*, *Pleurotus florida*, *Pleurotus cornucopiae*, and *Pleurotus eryngii*" in Mushroom Science IX (Part I). The Mushroom Research Institute, Japan.

F. Zadrazil, 1978. "Cultivation of *Pleurotus*" in The Biology and Cultivation of Edible Mushrooms ed. by S.T. Chang and W.A. Hayes, Academic Press, New York.

I. Heltay, 1980. "Pleurotus florida Production in Borota, Hungary". Mushroom Journal, London.



- SPECIES:** *Psilocybe cubensis* (Earle) Singer  
= *Stropharia cubensis* Earle.  
= *Stropharia cyanescens* Murr.  
= *Stropharia caerulescens* (Pat.) Sing.  
= *Naematoloma caerulescens* Pat.  
= *Hypholoma caerulescens* (Pat.) Sacc. & Trott.



**Figure 163** *Psilocybe cubensis* fruiting on cased grain.

**STRAINS:** Strains of *Psilocybe cubensis* are available from private and commercial stocks. The American Type Culture Collection, which sells cultures to educational organizations and research facilities, has stock cultures of several wild strains. Note that the strains listed below are *only* some of those that are presently circulating. There are many more. *Some* strains may originate from the same region but have features not in agreement with those described here.

**Amazonian:** Medium to large mushrooms on rye grain; thick whitish stems; tenaciously attached to the casing.

**Ecuadorian:** Medium sized mushrooms on rye grain; hemispheric caps; abundant primordia former; high yielding on compost; thin whitish stems; easily picked.

**Matias Romero:** Medium to large mushrooms on rye grain; early fruiter; thick whitish stems and tenaciously attached.

**Misantla:** Medium sized mushrooms on rye grain; thin yellowish stems; tall standing and easily picked.

**Palenque:** Large mushrooms on rye grain; high yielding; and easily picked.

**COMMON NAMES:** San Isidro; Cubensis.

**GREEK ROOT:** *Psilocybe* comes from the Greek root "psilos" meaning bald head and *cubensis*, a name Earle assigned to this mushroom because it was first recognized as a new species from specimens collected in Cuba,

**GENERAL DESCRIPTION:** A medium to large size mushroom having a cap that becomes convex to plane in age and is usually pigmented chestnut brown to deep yellowish or golden brown. The cap surface is finely fibrillose, sometimes covered with scattered, fugacious, cottony scales that soon disappear. The partial veil is membranous, well developed and typically leaving a persistent annulus on the upper regions of the stem. The stem is often longitudinally striate, powdered above the annulus and often covered with dense fibrils below. Flesh bruising bluish or bluish green. Its spores purplish brown in mass.

**NATURAL HABITAT:** Naturally found in horse and cow pastures, in dung or in soil enriched with manure. *Psilocybe cubensis* is a widely distributed species that is found Throughout tropical and subtropical zones of the world and is common in the pasturelands of the gulf coast of the southern United States and eastern Mexico.

## GROWTH PARAMETERS

**Mycelial Types:** Rhizomorphic to linear; whitish in overall color but often bruising bluish where injured.

**Standard Spawn Medium:** Rye grain. See Chapter III.

**Fruiting Substrate:** Rye grain; wheat straw; leached horse or cow manure; and/or horse manure/straw compost balanced to a 71-74% moisture content.

**Method of Preparation:** See Chapters III, V, and VI. Pasteurization achieved through exposure to live steam for 2 hours at 140°F. throughout the substrate. Straw or compost should be filled to a depth of 6-12 inches. Straw should be spawned at a rate of 2 cups/sq. ft.

**Spawn Run:**

*Relative Humidity:* 90%.

*Substrate Temperature:* 84-86°F. Thermal death limits have been established at 106°F.

*Duration:* 10-14 days.

*CO<sub>2</sub>:* 5000-10,000 ppm.

*Fresh Air Exchanges: 0 per hour.*

**Type of Casing:** After fully run, cover with the standard casing whose preparation is described in Chapter VIII. Layer to a depth of 1-2 inches. The casing should be balanced to an initial pH of 6.8-7.2,

**Post Casing/Prepinning:**

*Relative Humidity: 90 + %.*

*Substrate Temperature: 84-86 °F.*

*Duration of Case Run: 5-10 days.*

*CO<sub>2</sub>: 5000-10,000 ppm.*

*Fresh Air Exchanges: 0 per hour.*

*Light: Incubation in total darkness.*

**Primordia Formation:**

*Relative Humidity: 95-100%.*

*Air Temperature: 74-78 °F.*

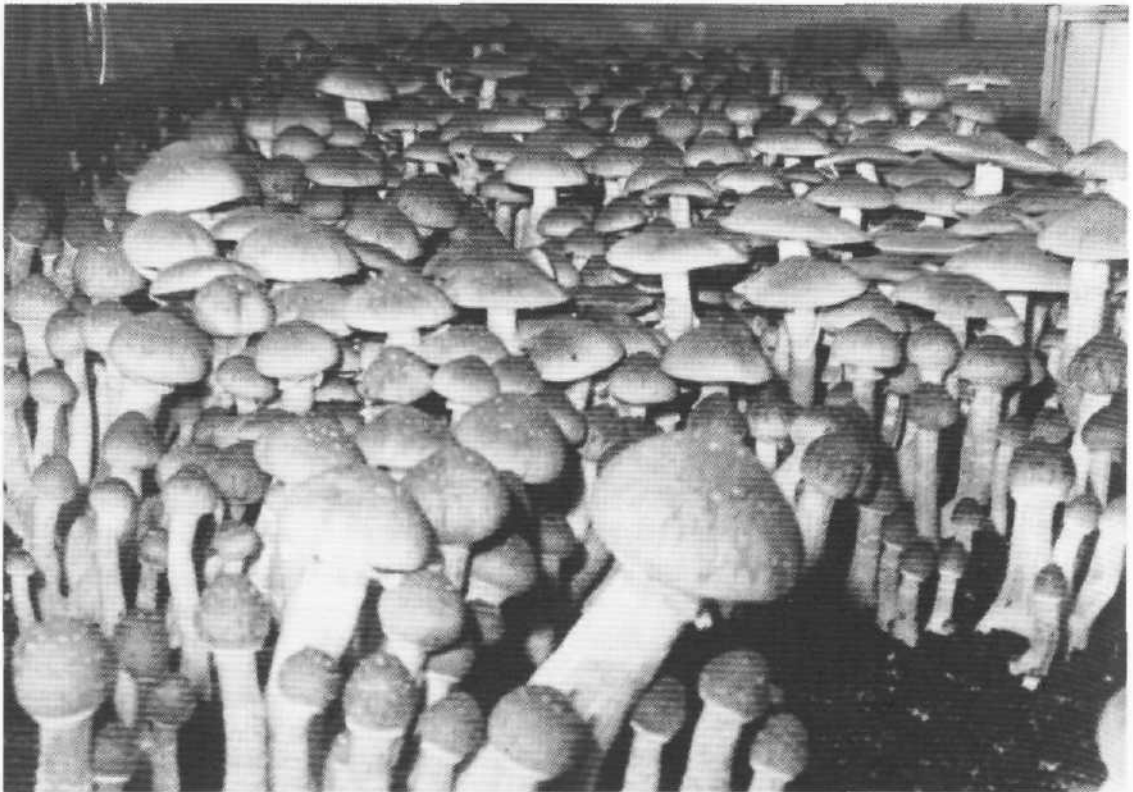

**Figure 164** *Psilocybe cubensis* fruiting on cased straw.

*Duration:* 6-10 days.

*CO<sub>2</sub>:* less than 5000 ppm.

*Fresh Air Exchanges:* 1-3 per hour.

*Light:* Diffuse natural or exposure for 12-16 hours/day of grow-lux type fluorescent light high in blue spectra at the 480 nanometer wavelength. (See Chapters IV and IX).

### **Cropping:**

*Relative Humidity:* 85-92%.

*Air Temperature:* 74-78 °F.

*CO<sub>2</sub>:* less than 5000 ppm.

*Fresh Air Exchanges:* 1-3 per hour.

*Flushing Pattern:* Every 5-8 days.

*Harvest Stage:* When the cap becomes convex and soon after the partial veil ruptures.

*Light:* Indirect natural or same as above.

**Yield Potential:** Average yields are 2-4 lbs./sq.ft. over a 5 week cropping period. Maximum yield potential has not been established.

**Moisture Content of Mushrooms:** 92% water; 8% dry matter.

**Nutritional Content:** Not yet established.

**Comments:** One of the easiest mushrooms to grow, this species fruits on a wide variety of substrates within broad environmental parameters. As a primary and secondary decomposer, *Psilocybe cubensis* fruits well on untreated pasteurized straw and on horse manure/straw composts transformed by microbial activity. Sterilized grain typically produces smaller mushrooms than bulk substrates. Given the numerous substrates that support fruitings, *Psilocybe cubensis* is well suited for home cultivation.

*Psilocybe cubensis* cultivation was unheard of twenty years ago. Today, this species ranks amongst one of the most commonly cultivated mushrooms in the U.S. and soon the world. This sudden escalation in interest is largely due to the publication of several popular guides illustrating techniques for its culture.

*Psilocybe cubensis* is a mushroom with psychoactive properties, containing up to 1 % psilocybin and/or psilocin per dried gram. The function of these serotonin-like compounds in the life cycle of the mushroom is not known.

**Genetic Characteristics:** Basidia tetrapolar (4-spored), forming haploid spores (1N); heterothallic. The mating of compatible monokaryons often results in fruiting strains. Clamp connections are present. See Chapter XV.

**For further information consult:**

Oss, O.T. and O.N. Oeric, 1976. "*Psilocybin: Magic Mushroom Grower's Guide*". And/OR Press, Berkeley.

**SPECIES:** *Psilocybe cyanescens* Wakefield  
= *Geophila cyanescens* (Maire) Kuhn. & Romagn,  
= *Psilocybe mairei* Singer



Figure 165 *Psilocybe cyanescens* fruiting indoors in a tray of alder chips.

**STRAINS:** St. Clair.

Many wild strains can be adapted to cultivation.

**COMMON NAMES:** Cyan; Grandote.

**GREEK AND LATIN ROOTS:** *Psilocybe* comes from the Creek "psilos" or bald head. The species name *cyanescens* is from "cyaneus" or blue for the color reaction of the flesh upon bruising.

**GENERAL DESCRIPTION:** Cap 20-50 mm. broad, convex to broadly convex to plane in age with an elevated and undulating margin which is, in turn, translucent-striate. The cap surface is smooth and viscid when moist from a separable gelatinous pellicle ("skin"). The color is caramel

---

brown, fading to yellow-brown to straw colored from the center. The gills are attached in an adnate to adnexed fashion, dull brown with whitish edges. The stem is 60-80 mm. long by 2-5 mm. thick, fibrous and enlarged towards the base. Its surface is smooth or powdered (pruinose). The stem color is whitish, silky and becomes blue where injured, with rhizomorphs protruding about the stem base. The partial veil is *cortinate* (cobweb-like), leaving little or no trace on the stem. Its spore print is dark purplish brown.

**NATURAL HABITAT:** Clustered in woody habitats; in soils high in the tissue of deciduous trees; or in tall rank grass. This species grows throughout the Pacific Northwest in areas well mulched by woody debris of deciduous and coniferous trees (typically not associated with bark). It has been reported from England and is thought to be broadly distributed throughout the European continent.

## GROWTH PARAMETERS

**Mycelial Types:** Rhizomorphic to closely linear; whitish in color.

**Spawn Medium:** Sawdust/bran or rye grain spawn.

**Fruiting Substrate:** A lignicolous species utilizing a number of wood types, most notably alder, maple and fir. It is able to grow on a wide variety of cellulosic wastes including newspaper and cardboard.

**Method of Preparation:** Branches and other small diameter wood are chipped into 1-3 inch pieces, preferably in the spring when the sap content is highest. This material is spawned with sawdust/bran (4:1) and made into prepared beds outdoors amongst ornamental shade plants (especially rhododendrons) or tall grass. Another method is to use sawdust/bran or rye grain spawn to inoculate soaked corrugated cardboard. When fully colonized, sheets of cardboard are laid at the bottom of trays which are then covered with a 2-4 inch layer of freshly cut alder chips. (Wood chips are far superior to sawdust as a fruiting substrate).

**Spawn Run:**

*Substrate Temperature:* 65-75 °F.

*Duration:* 30-60 days.

*Relative Humidity:* 90 + %

*CO<sub>2</sub>:* 10,000 ppm or higher.

*Fresh Air Exchanges:* 0 per hour.

**Type of Casing:** None required.

**Primordia Formation**

*Relative Humidity:* 95%.

*Air Temperature:* 50-60 °F.

*CO<sub>2</sub>:* 5000 ppm or below.

*Fresh Air Exchanges:* 2 per hour.

*Light requirements:* Diffuse natural or grow-lights.

---

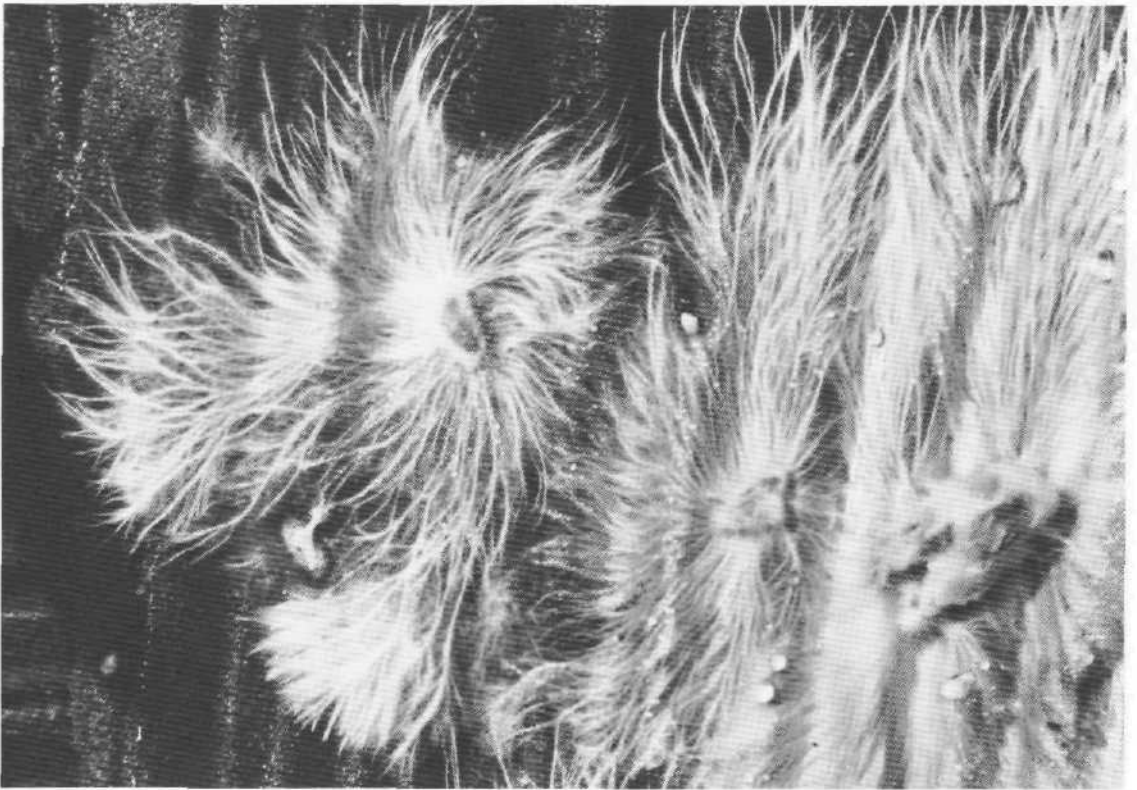

**Figure 166** *Psilocybe cyanescens* mycelium growing on soaked corrugated cardboard inoculated with grain spawn.

**Cropping:**

*Relative Humidity:* 85-92%.

*Air Temperature:* 50-60 °F.

*CO<sub>2</sub>:* 5000 ppm or below.

*Fresh Air Exchanges:* 2 per hour.

*Harvest Stage:* When the caps become nearly plane.

*Light:* Diffuse natural or grow-lights.

**Yield Potential:** In natural outdoor culture on alder chips, 1 lb. wet weight per square foot in one growing season is easily obtained.

**Moisture Content:** 90-92% water; 8% dry matter in fruitbodies.

**Comments:** *Psilocybe cyanescens* is a primary decomposer, readily digesting newly cut alder and other deciduous woods. Considered the granddote of the Pacific Northwest, this species is both

robust and potently psilocybian. Much sought after for its high psilocybin and psilocin content, it is a favored mushroom by those seeking entheogenic experiences.

*Psilocybe cyanescens*' adaptability to natural outdoor culture makes this species attractive to beginning and connoisseur cultivators alike. Virgin spawn can be collected from the wild and implanted in prepared beds (see Chapter VI) or spawn can be grown out on bran/sawdust or grain and inoculated directly onto unsterilized soaked corrugated cardboard. Grain spawn inoculated onto untreated wood chips is associated with a higher contamination rate than the same spawn implanted onto soaked cardboard, owing to the partial selectivity of the latter material.

Although fruitbodies can form on fresh sawdust, they do so reluctantly and belatedly. The fact that sawdust so readily loses its moisture may explain, in part, why *Psilocybe cyanescens* has difficulty fruiting on it.

*Psilocybe cyanescens* has a mycelium that is typically whitish and strandy (rhizomorphic). Tissue and spore cultures are easy to obtain. Outdoor colonies can be maintained for years with minimal effort and produce two to three flushes within a season.

See *Color Photos 17 & 18*.

---



**SPECIES:** *Psilocybe mexicana* Heim

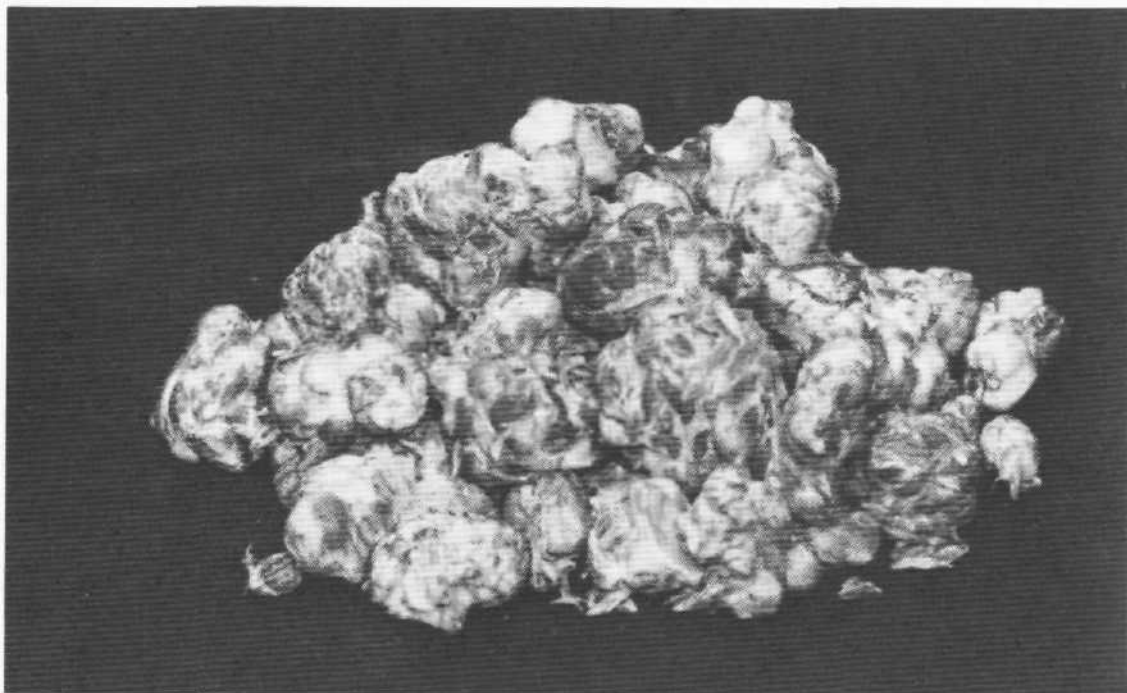

**Figure 167** Sclerotia of *Psilocybe mexicana* harvested from one cup of rye grass seed six weeks after inoculation.

**STRAINS:** Heim Strain  
Pollock Strain

**COMMON NAMES:** Mushroom of the Cods; Teonanácatl or God's Flesh; Nize (Mazatec Name); and Pajaritos (Spanish Name).

**GREEK ROOT:** *Psilocybe* comes from the Greek "psilos" or bald head. The species name *mexicana* denotes the country in which this mushroom grows.

**GENERAL DESCRIPTION:** Convex To subumbonate, sometimes with a small umbo, expanding in age To plane or nearly so. The surface is smooth, translucent-striate Two Thirds To the disc. The cap color is brownish to orangish grey to straw brown, more yellowish to the disc. The gills are adnately attached, grey to dark purplish brown. The stem is equal, smooth, hollow, pale straw to brown to reddish yellow, darkening when injured but typically not bruising bluish. Its spores are dark violet brown in mass.

**NATURAL HABITAT:** Solitary to numerous in grassy areas, horse pastures and meadows al-



**Figure 168** Two quart jars at 10 days and 30 days after inoculation onto rye grass seed.

though not occurring on dung. Distributed throughout subtropical regions in Mexico, common in the state of Oaxaca, and also known from Guatemala.

## GROWTH PARAMETERS

**Mycelial Types:** Slightly rhizomorphic to finely linear; off-white to tan in color, sometimes with multicolored zones.

**Spawn Media:** Annual rye grass seed or rye grain.

**Fruiting Substrates:** Rye grass seed and to a lesser degree rye grain and pasteurized wheat straw. Few fruitbodies form on enriched malt agar media.

**Method of Preparation:** Rye grass seed combined with water in a 2:1 volumetric proportion, preferably soaked overnight and then sterilized for 1 hour at 15 psi. Wheat straw is pasteurized in a hot water bath at 160-170°F. for 30 minutes.

### Spawn Run:

*Relative Humidity:* 90 + %

*Substrate Temperature:* 75-81 °F.

*Duration:* 10-14 days.

*Relative Humidity:* 90 + %.

*CO<sub>2</sub>:* 10,000 ppm or higher.

*Fresh Air Exchanges:* 0 per hour.

**Type of Casing:** Standard peat based casing whose preparation is described in Chapter VIII. Layer to a depth of ½-1 inch.

### Post Casing/Pre-pinning:

*Relative Humidity:* 90 + %.

*Substrate Temperature:* 75-81 °F.

*CO<sub>2</sub>:* 10,000 ppm or above.

*Fresh Air Exchanges:* 0 per hour.

*Light:* Incubation in darkness.

### Primordia Formation:

*Relative Humidity:* 95 + %.

*Air Temperature:* 71-74 °F.

*CO<sub>2</sub>:* 5,000 ppm or below.

*Fresh Air Exchanges:* 2 per hour.

*Light:* Diffuse natural or fluorescent grow-lights for 12 hours daily.

### Cropping:

*Relative Humidity:* 85-92%.

*Air Temperature:* 71 -74 °F.

*CO<sub>2</sub>:* 5000 ppm or below.

*Fresh Air Exchanges:* 2 per hour.

*Harvest Stage:* When the caps become nearly plane.

*Light:* Same as above.

**Yield Potential:** Not yet established. A petite mushroom. *Psilocybe mexicana* is an interesting species for the connoisseur. Because of the small stature of the fruitbody, one should expect low yields per square foot. Sclerotia formation on rye grass seed after two months is 50-70 grams per cup of seed.

**Moisture Content:** 90-92% water and 8% dry matter in fruitbodies; 70% water and 30% dry matter in sclerotia.

**Comments:** This species is most remarkable for its early formation of sclerotia—only three weeks after inoculation onto rye grass seed. Heim and Wasson (1958) considered sclerotia production in this species to be the most efficient method for the generation of biomass. Optimum temperature for sclerotia production was reported to be at 70-75 °F. in darkness. Sclerotia on agar media peaked at 4.5% malt concentration. Heim and Wasson also found fruitbody production was maximized on agar media when the percentage of malt was balanced to .45%. Nevertheless, sclerotia form best on rye grass seed incubated in total darkness.

### For further information consult:

“*Les Champignons Hallucinogenes du Mexique*” by R. Heim and R. G. Wasson, 1958. Editions du Museum National D'Histoire Naturelle, Paris.

See *Color Photographs 2 and 13.*

---

SPECIES: *Psilocybe tampanensis* Guzman and Pollock

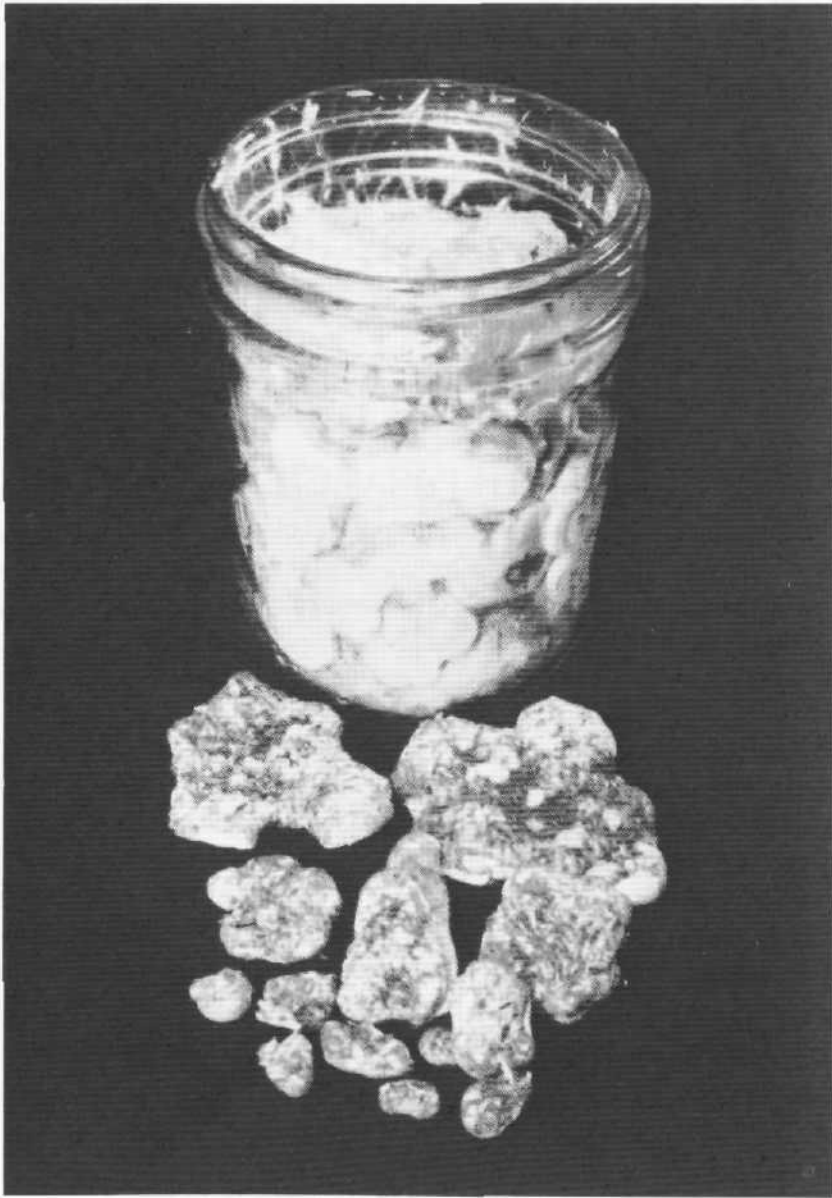

Figure 169 Sclerotia of *Psilocybe tampanensis* harvested from one cup of rye grass seed six months after inoculation.

**STRAINS:** Pollock Strain.

**COMMON NAMES:** The Tampa Psilocybe; Pollock's Psilocybe. Sclerotia are called The New Age Philosopher's Stone or Cosmic Comote.

**GREEK ROOT:** *Psilocybe* comes from the Greek "psilos" or bald head. The species name *tampenensis* denotes the city near which this mushroom was first collected.

**GENERAL DESCRIPTION:** Cap convex to subumbonate, soon broadly convex to plane. The surface is smooth and the color is ochraceous brown to straw brown to grey brown. The gills are adnately attached, dark violet brown with whitish edges. The stem is 20-60 mm. long by 3-5 mm. thick, fibrous and enlarged towards the base. The stem surface is smooth to powdered (pruinose) and its color is yellowish brown to reddish brown overall, with whitish to bluish mycelium at or around the base. Its spores are dark purplish brown in mass.

**NATURAL HABITAT:** Solitary to scattered in sandy soils and meadows in Florida (near the city of Tampa). This species is known only from the type locality where one wild specimen was collected.

## GROWTH PARAMETERS

**Mycelial Types:** Finely linear to cottony; tan to brownish in color, often multicolored with brownish hues.

**Spawn Media:** Annual rye grass seed, wheat grass seed or rye grain.

**Fruiting Substrate:** Cased rye grass seed (and possibly rye grain); leached cow manure; some potting soils; and enriched malt agar media. This species will probably fruit on cased pasteurized wheat straw.

**Method of Preparation:** Rye grass seed combined with water in a 2:1 volumetric proportion, preferably soaked overnight. Sterilize for 1 hour at 15 psi. Wheat straw is pasteurized in a hot water bath at 160-170 °F. for 20 minutes.

### Spawn Run:

*Relative Humidity:* 90 + %.

*Substrate temperature:* 75-81 °F.

*Duration:* 10-14 days.

*CO<sub>2</sub>:* 10,000 ppm or higher.

*Fresh Air Exchanges:* 0 per hour.

**Type of Casing:** Standard peat based casing whose preparation is described in Chapter VIII. Layer to a depth of ½ to 1 inch.

### Post Casing/Pre-pinning:

*Substrate temperature:* 75-81 °F.

*Relative humidity:* 90 + %.

*CO<sub>2</sub>:* 10,000 ppm or above.

*Fresh Air Exchanges:* 0 per hour.

---

*Light:* Incubation in darkness.

**Primordia Formation:**

*Relative Humidity:* 85-92%.

*Air Temperature:* 71-74°F.

*CO<sub>2</sub>:* 5000 ppm or below.

*Fresh Air Exchanges:* 2 per hour.

*Light requirements:* Diffuse natural or grow-lights for 12 hours/day.

**Cropping:**

*Relative humidity:* 85-92%.

*Air Temperature:* 71-74°F.

*CO<sub>2</sub>:* 5000 ppm or below.

*Fresh Air Exchanges:* 2 per hour.

*Harvest Stage:* When the caps become nearly plane.

*Light requirements:* Diffuse natural or grow-lights for 12 hours/day.

**Yield Potential:** A petite species, *Psilocybe tampanensis* is noted for its sclerotia forming ability, approximately 10-30 grams (wet weight) per cup of rye grass seed over 12 weeks. Because of the small stature of the fruitbody, one should expect low yields per square foot in comparison to other more fleshy species of *Psilocybe*.

**Moisture Content:** 90-92% water and 8-10% dry matter in fruitbodies; 70% water and 30% dry matter in sclerotia.

**Comments:** This mushroom would not be known but for a single specimen collected by Steven Pollock and Gary Lincoff in September of 1977. Cultures Taken from this wild specimen were marketed by Hidden Creek Inc. under the name of the "Cosmic Comote".

Sclerotia do not form until the fourth week (typically six to eight weeks) after inoculation of rye grass seed. To encourage sclerotia production only, incubate mycelia on rye grass seed at 75°F. in complete darkness.

**For further information consult:**

"*Magic Mushroom Cultivation*" by Steven H. Pollock, 1977. Herbal Medicine Research Foundation, San Antonio, Texas (out of print).

See *Color Photographs 4, 14 and 15.*

---

**SPECIES:** *Stropharia rugoso-annulata* Farlow apud Murrill  
= *Stropharia ferii* Bresadola  
= *Naematoloma fern* (Bres.) Singer

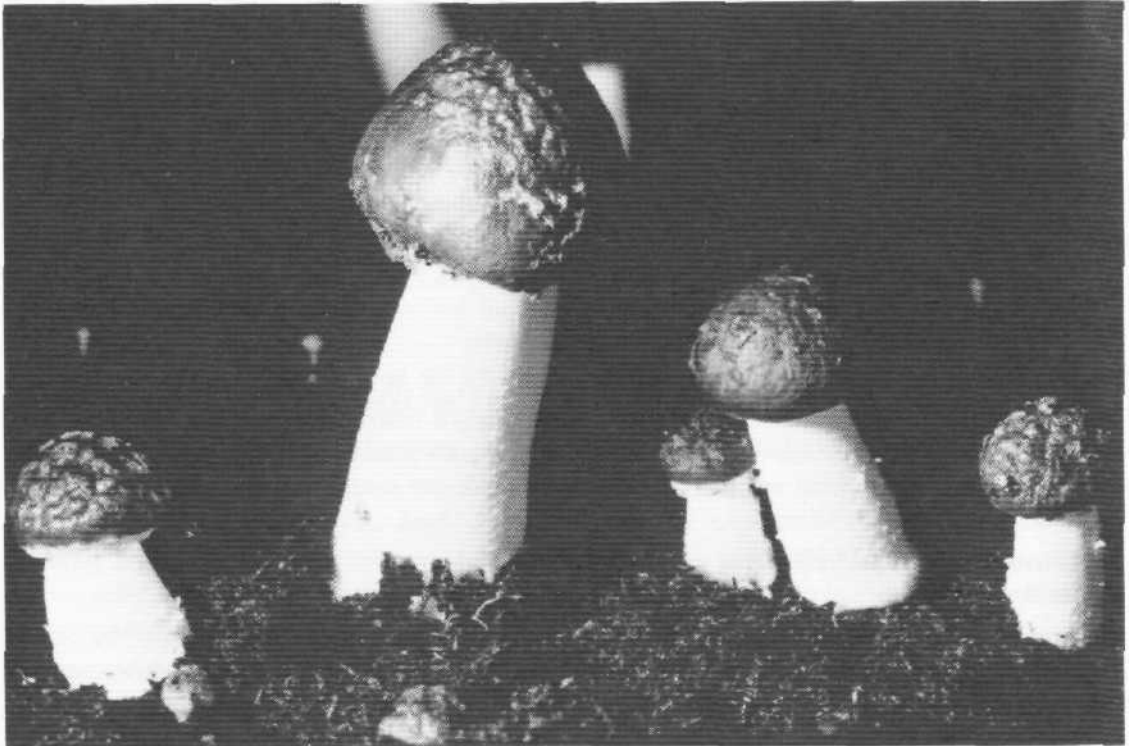

**Figure 170** Young fruitbodies of *Stropharia rugoso-annulata* fruiting on pasteurized straw cased with peat.

**STRAINS:** Gartenriese  
Winnetou  
Gelbschopf

The above listed strains are of European origin. Many strains of this species are available from culture banks, including those maintained by the American Type Culture Collection and Pennsylvania State Buckhout Laboratory. Strains are easy to obtain from the spores and tissue of wild specimens.

**COMMON NAMES:** The Wine Red Stropharia; The Giant Stropharia.

**LATIN ROOT:** *Stropharia* means "sword belt", so named for the belt-like ring on the stem. The species epithet *rugoso-annulata* comes from the combination of two Latin words: "rugosus" meaning wrinkled and "annulus" or ring.



**Figure 171** Buttons of *Stropharia rugoso-annulata* fruiting outdoors in a bed of wood chips.

**GENERAL DESCRIPTION:** A large, thick fleshed mushroom with a broadly convex cap measuring 50-400 mm. in diameter, darkly pigmented yellowish brown with distinct reddish tones. The partial veil is thick, membranous, leaving a persistent membranous ring on the stem on whose uppersides are tiers of gills. The stem is whitish and has rhizomorphs attached to its base. Its spores are dark purplish brown in mass.

**NATURAL HABITAT:** Occurring in gardens, in wood chips, on decomposing straw, in sawdust enriched soils and commonly in grounds where potatoes have been planted.

## GROWTH PARAMETERS

**Mycelial Types:** Rhizomorphic to closely linear; whitish in color.

**Standard Spawn Media:** Rye grain or chopped wheat straw.

**Fruiting Substrates:** Cased wheat straw, whole or chopped, and balanced to a 71 -74% moisture content. This species has been grown on a substrate of alder/maple chips mixed with mature horse manure using natural culture techniques.



**Method of Preparation:** Either chopped or whole straw is adequate, although permeation is more rapid on the former. (See Chapter VI on preparation of straw as a fruiting substrate). Pasteurization is achieved through the submersion of straw into a hot water bath at a temperature of 160 °F. for 20-30 minutes. The straw, once pasteurized and inoculated, should be compacted and filled to a depth of 6-12 inches. Gramss (1979) noted That wheat straw supplemented with 25% Fagus saw-dust enhanced yields. Watling (1980) reported, without elaboration, that fruitbodies form on a saw-dust based medium. This species also fruits on unpasteurized straw although problems with insect pests and competitor molds are more pronounced.

**Spawn Run:**

*Relative Humidity:* 90 + %.

*Substrate Temperature:* 76-82 °F. Thermal death limits have been reported as low as 90 °F. and -5 °F.

*Duration:* 2-4 weeks.

*CO<sub>2</sub>:* 5000-10,000 ppm.

*Fresh Air Exchanges:* 0 per hour.

**Type of Casing:** After fully run, cover with peat/humus (1:1) casing. Optimally, the casing should have a pH of 5.7-6.0. (Because calcium based buffers inhibit fruiting, adjust the casing's pH by increasing or decreasing amount of peat). Balance to a 70-75% moisture content. Layer to a depth of 1-2 inches. Humus should be pasteurized to kill nematodes, mites, and other parasites. Some strains form fruitbodies solely on a peat casing. (Mushrooms do not form, however, on sterilized casing. Hence, if the casing must be treated, steam pasteurization is recommended).

**Post Casing/Prepinning:**

*Relative Humidify:* 90 + %.

*Bed Temperature:* 76-82 °F.

*Duration of Case Run:* 10-12 days.

*CO<sub>2</sub>:* 5000-10,000 ppm.

*Fresh Air Exchanges:* 0 per hour.

*Light:* Incubation in darkness.

**Primordia Formation:**

*Relative Humidify:* 95 + %.

*Air Temperature:* 55-62 °F.

*CO<sub>2</sub>:* less than 1000 ppm.

*Fresh Air Exchanges:* 2-4 per hour.

*Watering:* Regular misting (once to twice daily) to help stimulate primordia formation.

*Light:* Indirect natural or exposure to grow-lux type fluorescent for 12 hours/day.

**Cropping:**

*Relative Humidify:* 85-92%.

---

*Air Temperature:* 55-62 °F.

*CO<sub>2</sub>:* less than 1000 ppm.

*Fresh Air Exchanges:* 2-4 per hour.

*Flushing Interval:* Every 10-15 days.

*Harvest Stage:* Directly before or as the partial veil tears. (Note that young mushrooms have a much better flavor than mature ones).

*Light:* Indirect natural or exposure to grow-lux type fluorescent for 12 hours/day.

**Yield Potential:** Average commercial yields are 2-3 lbs./sq.ft. over a 8 week cropping period. Maximum yields are nearly 6 lbs per square foot.

**Moisture Content of Mushrooms:** 92% water; 8% dry matter.

**Nutritional Content:** 22% protein (dry weight); 34 milligrams of niacin per 100 grams dry weight.

**Comments:** A mushroom recently cultivated in Europe (Germany, Czechoslovakia and Poland) by home growers in outdoor cold frames, The status of knowledge regarding the optimum growing parameters for this species remains in its infancy. For instance, Szudyga (1978) noted that fruitbodies form just as well at 50 °F. and 68 °F., a considerable fruiting range for any species.

After the cropping period ends, the spent straw is used as fodder for farm animals or is saved for future inoculations. The strain is kept kept alive by continuous transfer onto fresh substrates. (See Chapter VI on natural culture). Propagating spawn in this way, however, is less assured than sterile methods.

Stanek (1974) reported that the introduction of several thermotolerant endospore-forming bacteria of the genus *Bacillus* (*B. subtilis*, *B. menseaticus* and *B. macerans*) to the casing not only inhibited attacks by competitors but also stimulated mycelial growth which presumably would enhance yields. Endospores of these bacteria survive pasteurization but not sterilization, and are abundant in soils. This discovery may explain why sterilized casings do not produce fruitbodies,

**Genetic Characteristics:** Basidia tetrapolar (4-spored), forming haploid spores; heterothallic. Clamp connections are present. See Chapter XV.

**For further information consult:**

K. Szudyga, 1978. "*Stropharia rugoso-annulata*" in The Biology and Cultivation of Edible Mushrooms ed. by ST. Chang and W.A. Hayes. Academic Press, New York.

**SPECIES:** *Volvariella volvacea* (Bull. ex Fr.) Sing.

**STRAINS:** Many strains of *V. volvacea* are available from commercial and private stocks. The American Type Culture Collection, which sells cultures to educational organizations and research facilities, has stock cultures of several wild and domesticated strains. Several commercial companies also sell strains of this species.

**COMMON NAMES:** The Paddy Straw Mushroom; The Chinese Mushroom.

**LATIN ROOT:** *Volvariella* is the conjunction of two words: "volvatus" which means having a volva or cup-like sheath and the suffix "-ellus" denoting smallness in size. The species name *volvacea* shares the same root as the genus.

**GENERAL DESCRIPTION:** Mushrooms whitish at first, becoming a dark tan as the veil tears and eventually a pale tan with age. Fruitbodies are relatively small when young, enveloped by a sheath-like universal veil, soon breaking as the fruitbodies mature and leaving an irregular cup-like sack at the base of the stem. The cap is egg shaped at first, soon hemispherical to convex and expanding to plane with age. Its spores are pinkish to pinkish brown in mass.

**NATURAL HABITAT:** Commonly occurring in decomposing straw in the Orient and in other subtropical regions of the world.

## GROWTH PARAMETERS

**Mycelial Types:** Fast growing rhizomorphic to slow cottony mycelia noted. The color is typically white to grayish white.

**Spawn Medium:** Rice straw or rye grain. See Chapter III.

**Fruiting Substrate and Method of Preparation:** Traditionally grown on rice straw that has been composted for 1-2 days. More recently Hu (1974) found that a mixture of cotton wastes supplemented with wheat bran and calcium carbonate (5% and 5-6% by weight, respectively) and composted for 3 days, pasteurized for 2 hours at 140° F., conditioned for 8 hours at 125° F. and then gradually lowered to 77° F. over a 8-12 hour period, produced a higher yielding substrate than that of others previously used. A moisture content of 65-70% is recommended for rice straw and 70% for cotton waste mixtures. Chang (1978) recommended a combination of the two—with the rice straw/cotton waste in a proportion of 2:1 or 1:1 by weight.

**Spawn Run:**

*Relative Humidity:* 90 + %.

*Substrate Temperature:* Fastest growth at 88-95°F.

*Duration:* 4-6 days for thorough colonization.

*CO<sub>2</sub>:* 5000-10.000 ppm.

*Fresh Air Exchanges:* 0 per hour.

*Light Requirements:* Incubation in total darkness.

**Type of Casing:** None needed.

---

**Pinhead Initiation:**

*Relative Humidity:* 95 + %.

*Air Temperature:* 82-88 °F.

*Duration:* 4 days.

*CO<sub>2</sub>:* less than 1000 ppm.

*Fresh Air Exchanges:* 2-4 per hour.

*Light:* Diffuse natural or direct grow-light fluorescent for 12-18 hours per day.

*Watering:* Regular misting once to twice daily.

**Cropping:**

*Relative Humidity:* 85-92%.

*Air Temperature:* 82-88 °F.

*Duration:* 5-7 weeks.

*CO<sub>2</sub>:* less than 600 ppm.

*Fresh Air Exchanges:* 2-4 per hour or sufficient to meet CO<sub>2</sub> and/or cooling requirements.

*Harvest Stage:* Directly before rupturing of the universal veil.

*Flushing Intervals:* 5-10 days.

*Light:* Same as above.

*Watering:* Regular misting to prevent caps from cracking and to keep resting pinheads viable.

**Yield Potential:** Average commercial yields on rice straw are 22-28 kilograms of fresh mushrooms per 100 kilograms of dry straw. Optimum yields on cotton waste compost are 25-35 kilograms per 100 kilograms of substrate. Maximum yields are nearly 45 kilograms on cotton waste compost.

**Moisture Content of Mushrooms:** 88-90% water; 10-12% dry matter.

**Nutritional Content:** Crude protein is reported at 21.2 % of dry weight; 91 milligrams of niacin per 100 grams dry weight.

**Comments:** In contrast to other species growing on straw, this mushroom does not compare favorably in terms of yield. The smaller crop figures are probably a result of the early picking of the mushroom fruitbodies, when they are most flavorful.

Several researchers have noted the difficulty of maintaining high yielding strains of this species for any length of time. Its mycelium seems to have a limited transfer potential and should be stored at moderate temperatures (50 °F.). Cultures are frequently renewed through multispore germinations.

*Volvariella volvacea* is primarily grown in the Orient and is a warmth loving mushroom.

**Genetic Characteristics:** Basidia tetrapolar, producing 4 haploid spores; primary homothallic. Clamp connections are present. Chlamydospores form. See Chapter XV.

**For more information** consult:

ST. Chang, 1972. "The Chinese Mushroom (*Volvariella volvacea*): Morphology, Cytology,

Genetics, Nutrition and Cultivation" The Chinese University of Hong Kong, Hong Kong.

S.T. Chang, 1978. "*Volvariella volvacea*" in *The Biology and Cultivation of Edible Mushrooms*, pp. 573-603. Academic Press. New York.

## CHAPTER XII CULTIVATION PROBLEMS AND THEIR SOLUTIONS: A TROUBLE-SHOOTING GUIDE

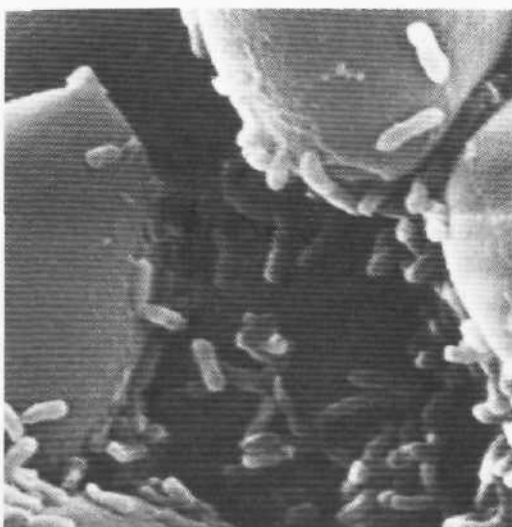
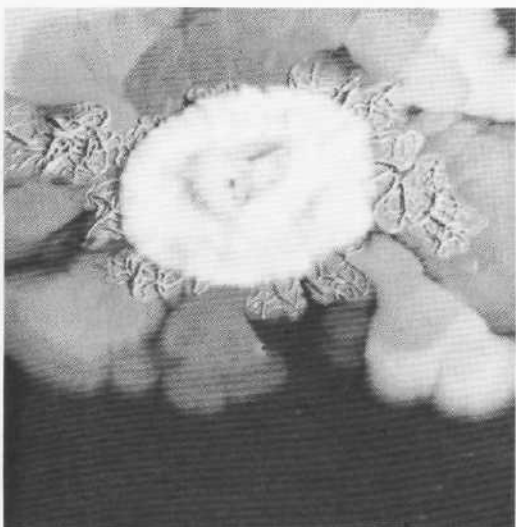
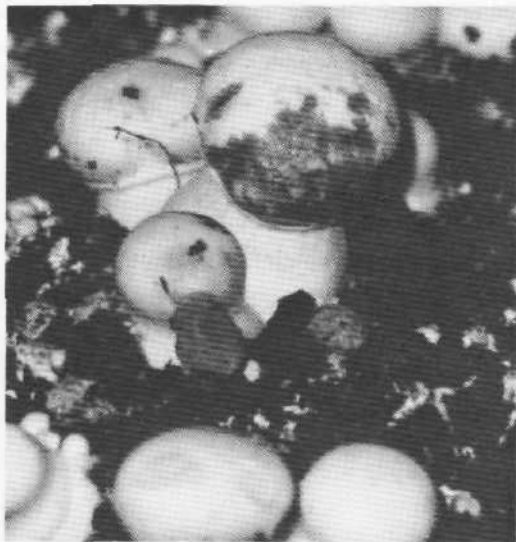

Figure 172a,b,c,d. The results of bacterial contamination.

**M**any first-time cultivators fail to grow mushrooms for the simplest of reasons. Often times the slightest error in technique sets into motion a series of events that drastically influence the outcome of the crop. Whenever conducting sterile technique, making spawn, preparing compost or cropping mushrooms, wise cultivators follow a routine that has proven successful in the past. Once a consistent methodology has been established, new variations are introduced, one at a time, to gauge their effect.

Problems intrinsic to mushroom culture have been encountered by most everyone attempting to grow mushrooms. The following trouble-shooting guide lists problems, causes and solutions according to their frequency of occurrence and has been organized into five categories:

1. **Sterile Technique:** media (agar and grain) preparation, spore germination, tissue culture and spawn-making.
2. **Compost Preparation:** raw materials, characteristics of composts at different stages, Phase I and Phase II.
3. **Spawn Running:** colonization of compost and bulk substrates.
4. **Case Running:** application, colonization by mycelium, pre-pinning strategy.
5. **Mushroom Formation and Development (Pinning to Cropping):** strategy for pinhead formation, maturation and harvesting.

Identify the problem, locate it on the list, read its possible causes, refer to the solutions available, and if indicated, turn to the chapter noted in parentheses. Good luck, pay attention to detail and may your problems be few.

## STERILE TECHNIQUE

PROBLEM	CAUSE	SOLUTION
<b>Agar Culture</b>		
Media fails to solidify.	Insufficient quantity of agar or distribution thereof.	Thoroughly mix media before pouring,
Media boils out of vessel or flask containing it.	Excessive escape of steam from pressure cooker.	Do not vent pressure cooker until reaching 1 psi. Crease pressure cooker seals with thin film of petroleum jelly. For pressure cookers using 5, 10, 15 lb weights, do not operate so steam escapes.
Contamination occurs in petri dishes after pouring media but before inoculation.	High contaminant spore load in lab.	Clean, paint lab. Install laminar flow hood.
	Improper media preparation technique.	Allow pressure cooker to cool in sterile setting before opening.
	Contaminated pressure cooker (bacteria).	Sterilize pressure cooker for 24-48 hours at 15 psi.
No growth from spores or tissue transferred.	Wrong type of media.	See media preparation.
	Wrong pH	See media preparation
	Old or dehydrated spores.	Soak in sterilized water for 12-24 hours.
	Scalpel or loop too hot.	Cool tool before contacting spores or tissue.
	Sugar in media caramelized.	Lower sterilization pressure and temp. to recommended levels.



PROBLEM	CAUSE	SOLUTION
Contamination occurs around point of transfer onto agar media.	Inoculum (spores or tissue) contaminated.	Obtain "cleaner" spores or take a <i>tissue culture</i> from a fresher specimen, or inoculate as many plates as possible, saving only those not becoming contaminated.
	Inoculation tools not sterile.	Autoclave tools, soak in alcohol, flame sterilize before using.
Rhizomophic mycelia becomes <i>cottony</i> , slow growing. Fruitings diminish. Strain appears to be degenerating.	Senescence, strain aging.	Retrieve stock cultures and re-activate a strain of known vigor.
	Mutating. Sugar in media caramelized. Media containing mutagens.	Alternate media so that gene expression is <i>not</i> selected by a limited chemical matrix. Cook agar media at lower temp. and pressure, between 12 and 15 psi.
	Insufficient jelling agent causing mycelium to grow subsurface and appear <i>cottony</i> .	Add more agar or thoroughly mix media before pouring petri dishes.
<b>Grain Culture</b>		
Glass spawn jars broken when pressure cooker is opened.	Pressure cooker cooled too rapidly. Change in temp. too abrupt.	Allow cooker to descend to room temp. <i>gradually</i> .
	Jars too tightly packed.	Allow space so jars can expand.
	Jars defective or cracked.	Check for cracks or defects. Obtain new jars.
	Wrong type of jars.	Replace with canning or autoclavable type.

PROBLEM	CAUSE	SOLUTION
Grain jars difficult to shake.	Too much grain in container.	Reduce grain to recommended levels.
	Too much water relative to grain.	Follow recommended formulas.
	Measuring cups not accurate.	Calibrate measuring cups with a graduated cylinder.
Grain "spontaneously" contaminates before inoculating or opening pressure cooker.	Introduction of alien spores upon cooling.	Cool-down in sterile environment or in front of laminar flow hood.
	Survival of bacterial endospores despite autoclaving.	Replace source of grain or presoak grain for 24 hours before autoclaving.
Agar wedge sticks to glass when grain jar is shaken.	Agar media too thin, either from evaporation or from shallow pouring.	Use mycelium covered media before substantial evaporation occurs. Pour more media into each petri dish initially.
Little or no growth after mycelial wedge has been transferred.	Grain too hot when inoculated.	Allow to cool to room temperature before inoculating.
	Grain too dry.	Balance according to recommended recipes.
	Mycelium not evenly distributed.	Vigorously shake spawn jar after transfer of agar wedge and again 3-5 days after inoculation.
	Incubated at wrong temperature.	See recommended spawn incubation temperatures in Chap. XI.
	pH wrong.	Buffer with calcium carbonate according to species being cultured.
Wrong spawn medium.	Use media recommended for that species.	

PROBLEM	CAUSE	SOLUTION
Poor strain.	Contaminated strain.	Discard strain. Obtain purer strain, make up more grain media and clean laboratory.
No growth on grain after inoculated with liquid culture/stirrer technique.	Too many individual hyphae (cells) severed.	Stirred for too long. No more than 5 seconds is recommended for high speed laboratory-type blenders to produce fragmented chains of hyphae.
	Bacteria,	Replace mycelia with pure strain, free of bacteria. Be sure tools and water are sterile before inoculation.
	Poor strain.	Cottony type mycelia is slow growing. Replace with rhizomorphic or faster growing strain.
	pH	Follow recommended recipes. See Chap. II.
	Water too hot.	Allow to cool before inoculating.
Contamination after transfer of mycelium.	High contaminant spore count in laboratory.	Clean lab before inoculations. Maintain high standards of hygiene.
	Tools not sterile.	Autoclave tools, soak in alcohol, flame sterilize before inoculation.
	Mycelium being transferred has high resident load of contaminant spores.	Obtain cleaner strain or spawn of better purity.
Mycelium fails to grow out through entire spawn jar.	Insufficient shaking of grain after inoculation.	Thorough shaking after double-wedge transfer, combined with re-shaking four days after inoculation.

PROBLEM	CAUSE	SOLUTION
	Mycelium inhibited by contamination (usually bacteria). Externally or internally introduced.	Inoculate more sterilized grain using a pure strain and following standard practices for doing so. See Chap. II.
Top kernels in spawn jar not colonized by mycelium.	Top kernels dehydrated from excessive evaporation.	If using porous filter discs, limit evaporation. Or use only in conjunction with narrow mouthed jars.
Spawn jar discolored with yellowish droplets of fluid.	Spawn jar incubated for an overly long period of time, at higher than optimum temperatures, or both, causing the exudation of metabolites ("sweat") and the build-up of fluids in which bacteria thrive.	Incubate at temperature and for period of time recommended for species being cultivated.

## COMPOST PREPARATION

### Phase I

Compost does not heat up, remains under 140 °F.

Undersupplemented.

Check compost formula. Check Nitrogen content of raw materials.

Pile too open, airy.

Compress pile sides. Protect pile from strong winds.

Moisture content too high or low.

Balance moisture to 70%.

Insufficient pile mass.

Increase total raw materials.

Compost generates no ammonia.

Undersupplemented.

Check compost formula calculations. Check Nitrogen content of raw materials.

PROBLEM	CAUSE	SOLUTION
Compost anaerobic.	Moisture content too high. Straw too short; pile too dense,  Pile sitting too long between turns.	Balance moisture to 70%. Carefully monitor raw materials and adjust pile size as materials compact.  Turn more frequently.
Compost decomposing unevenly.	Improper turning procedures.  Variable starting materials.	Move inside of pile To outside and vice versa.  Horse manure or straw should all be in the same state of decomposition at the start of composting.
Compost greasy.	Gypsum quantity too low. Starting materials too old.	Add more gypsum. Use <i>only</i> fresh, undecomposed starting materials.
Compost too wet or too dry at filling.	Incorrect water addition or timing.	Check moisture content of pile before each Turn.
Straws still bright and shiny at filling.	Phase I too short.	Continue composting.
Compost short and black at filling.	Phase I too long.	Shorten Phase I.
Phase II		
Compost will not heat up.	Supplementation rates too low. Compost too mature. Oversupply of fresh air. Air to bed ratio too great.  Compost too wet.	Check compost formula calculations. Shorten Phase 1. Reduce fresh air supply. Add more beds or trays and fill with more compost.  Compost should be 70% at filling.

PROBLEM	CAUSE	SOLUTION
Compost temperature erratic.	Irregular fresh air supply.	Fresh air supply should be constant. Make volume changes slowly and as needed to stabilize temp.
	Room environment not monitored enough.	Check room every 4-6 hours.
Compost temperature uneven.	Containers filled unevenly.	Fill all containers with equal amounts of compost and to the same depth.
	Uneven supplement distribution in Phase I.	Be sure supplements are evenly mixed and are not concentrated in small pockets.
	Faulty air system design.	Air system should insure even temp. throughout the room.
Compost temp. too high after pasteurization.	Inadequate supply of fresh air.	Increase fresh air.
	Pasteurization too long.	Pasteurize for 2 hours at 140 °F.
Compost temp. drops too low after pasteurization.	Prolonged fresh air supply.	Anticipate drop in compost temp. and reduce fresh air before reaching conditioning temp.
	Pasteurize at a lower temp. for more time.	Low temperatures preserve more microorganisms that prevent temp. from falling rapidly.
Prolonged ammonification.	Oversupplementation with nitrogen.	Reduce nitrogen supplements.
	Prolonged time at temp. over 130 °F.	Keep temp. under 130 ° after pasteurization. Use low temp. ranges during conditioning.

## SPAWN RUNNING

PROBLEM	CAUSE	SOLUTION
Spawn grows slowly or not at all.	Inferior spawn.	Check spawn making procedures. Review strain storage methods. Test strain purity by inoculating agar plates.
	Degenerative or inviable strain.	Always test untried strains in "miniculture" trials prior to inoculation into bulk substrates. Switch to a strain of known viability.
	Residual ammonia in compost.	Prolong Phase II conditioning until litmus paper test shows no color change.
	Improper Phase I or Phase II.	Review composting section.
	Substrate moisture content too high.	Compost should be 64-66% water; straw should be 70-75% at spawning.
	Fly or nematode infestation.	Check pasteurization time and temperature.
	Mycelium lacks oxygen.	Be sure the container has provisions for air exchange.
Molds present during spawn run.	Improper Phase I or Phase II.	Review composting section. Check contamination section for identification and factors predisposing to mold growth.
Inky Caps ( <i>Coprinus sp.</i> ) occur during spawn run.	Residual ammonia in compost.	Prolong Phase II conditioning until litmus paper test shows no change.
Mites or nematodes present.	Insufficient pasteurization.	Pasteurize 2 hrs. at 140° F.
	Compost with dense <i>overwet</i> areas.	Review composting and filling procedures.
	Unclean substrate containers or spawning tools.	Containers and tools should be disinfected before use.

PROBLEM	CAUSE	SOLUTION
Mycelium covers the casing but forms few primordia.	"Overlay" caused by prolonged mycelial growth into the casing layer.	Patch the casing. Begin initiation sequence sooner. If dealing with a slow pinning strain be careful that the evaporation rate off the casing surface is not excessive.
Mycelium <i>overlays</i> the casing and then "mats", becoming flattened and impervious to water. No primordia form.	Improper watering and/or too low humidity in the external environment. Evaporation rate too extreme.	Scratch and/or re-case. Maintain 95% humidity at <i>pinning</i> . Reduce evaporation rate. If watering, mist lightly and evenly.
Mycelium runs through the casing and Then disappears.	Die Back Disease (Virus).	Discard and begin anew with a virus-free strain. See Chap. XIII.
Dense white matted zones form on casing.	Stroma.	Select strains not predisposed to stroma formation (those without fluffy sectors). Reduce CO <sub>2</sub> .
	Contaminant ( <i>Scopulariopsis</i> ).	pH too high. Compost improperly prepared. See Chapters V, XIII.



## MUSHROOM FORMATION AND DEVELOPMENT

PROBLEM	CAUSE	SOLUTION
<b>Pinhead Initiation</b>		
Mycelium fails to form primordia.	Monokaryotic strain with low or no fruiting ability.	Start again with new tissue isolate or isolate from multi-spore germination,
	Humidity too low.	Keep humidity at 95% during pinning.
	CO <sub>2</sub> too high.	Reduce CO <sub>2</sub> by introducing fresh air.
	Temperature too high.	Decrease air temp. to the fruiting range.
	Insufficient light.	Illuminate cropping surface for 12 hours/day.
Primordia form early.	Uneven casing depth.	Apply casing at an even depth and patch areas where mycelium appears prematurely.
	Early light stimulation.	Incubate culture in darkness until ready to pin.
	Temperature too low.	Incubate at optimum temp. for mycelial growth and then drop temp. for pinning.
	CO <sub>2</sub> levels too low.	Maintain airtight room and recirculate air until ready to pin.
Primordia formation uneven.	Uneven casing depth.	Patch shallow areas as mycelium appears until growth is even.
	Uneven moisture in casing.	Water casing evenly and carefully.
	Casing surface partially damaged from heavy watering.	Keep casing surface open and porous through proper misting techniques.
	Uneven environmental conditions within the growing room.	Review air system design.

PROBLEM	CAUSE	SOLUTION
Pinheads fail to form abundantly.	Casing layer moisture too low or too high.	Adjust moisture level in casing to 70-75% for pinhead formation.
	Casing layer pH imbalanced.	Adjust pH to levels recommended in Chap. XI for the species being cultivated.
	Magnesium in limestone buffer too high (above 2%).	Some species are inhibited by minerals in the casing layer, especially the magnesium in dolomitic limestone. Use a low magnesium lime, less than 2%.
	CO <sub>2</sub> too high.	Lower CO <sub>2</sub> to recommended levels. (Some species fruit poorly in high CO <sub>2</sub> environments).
	Insufficient light.	Photosensitive species require several hours of light stimulation per day for pinhead formation.
	Improper pinhead initiation strategy.	See Chapter IX.
	Defective strain.	Replace with strain of known viability.
	Nematode infestation.	See Chapter XIV.
Pinheads form but fail to mature.	Insufficient nutrient base.	Review substrate materials and formulas. Follow those that are recommended for the species being cultivated.
	Excessive CO <sub>2</sub> levels,	Reduce CO <sub>2</sub> to recommended levels.
	Humidity too high.	Reduce humidity to 85-92%.
	Insufficient fresh air.	Increase fresh air input to 2-4 room exchanges per hour.
	Strain idiosyncrasy.	Replace with a strain having better fruiting capabilities.

PROBLEM	CAUSE	SOLUTION
	Fly, nematode or other contaminant inhibiting development.	Review contaminant control procedures. Check source and quality of casing materials. Check mixing procedures.
	Excessive loss of moisture from casing.	Maintain sufficient moisture (70-75%) in the casing through daily mistings if required.
<b>CROPPING</b>		
Low yielding first flush.	Poor pin set.	Review pinning procedures and growing parameters for the species being grown.
	Substrate low in nutrients.	Review substrate materials and formulas.
Few mushrooms develop fully, many abort.	Uneven pinning.	Remove early developing pins.
	Lack of nutrients.	Review substrate materials and formulas.
	Temperature too high.	Maintain air temp. within cropping range.
	Parasitized by contaminant.	See Chapters X and XIII. Follow procedures for encouraging cropping, not contamination.
Mushrooms have long stems and small underdeveloped caps.	CO <sub>2</sub> too high. Insufficient lighting.	Increase fresh air input. Evaluate lighting system and used.

---

PROBLEM	CAUSE	SOLUTION
Mushrooms develop but abnormally.	Parasitized by contaminant.	Eliminate stagnant air pockets in the growing environment. See Chap. IV.
	Excessive CO <sub>2</sub> . Improperly balanced growing environment.	Lower CO <sub>2</sub> to recommended levels. Maintain air circulation, temp. and humidity at recommended levels. See Chap. X.
	Exposure to mutagenic chemicals (insecticides, detergents, chlorine, etc.)	Limit exposure of mushrooms to such chemicals.
	Lack of adequate light for fruitbody development.	Increase light exposure to 12 hours per day. See Chapters IV and IX.
	Strain idiosyncrasy.	Switch to strain of known fruiting ability.

---

# CHAPTER XIII

## THE CONTAMINANTS OF MUSHROOM CULTURE

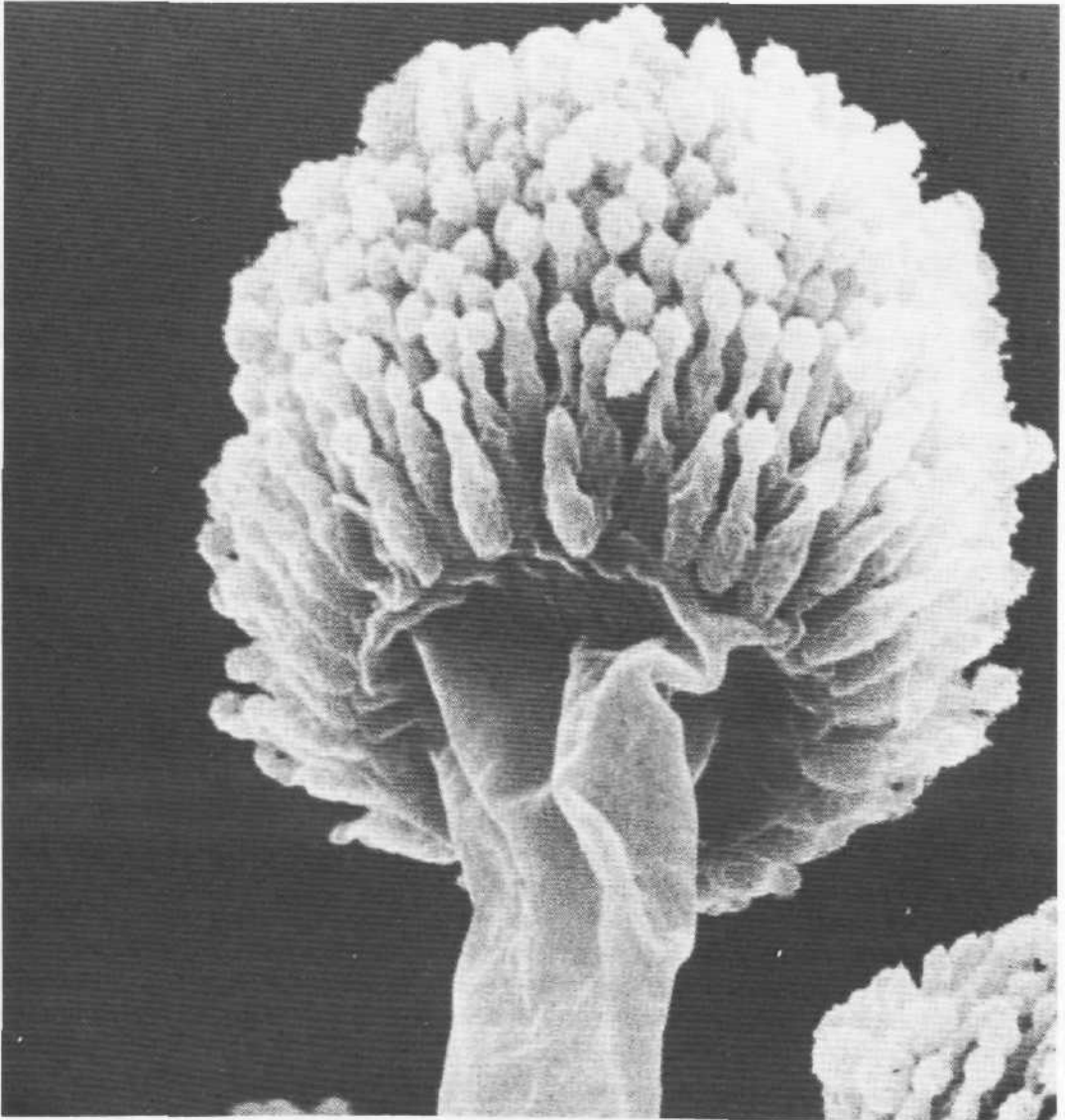

Figure 173 Sporulating structure of *Aspergillus* mold.

The contaminants are so named solely because they are undesired. If one were trying to culture *Penicillium* and spores of an *Agaricus* or *Psilocybe* settled onto the agar media and germinated, the resulting mycelia would be the so-called "contaminant." The contaminants in mushroom culture, however, are primarily molds, bacteria, viruses and insects. The pathway by which a disease is introduced, known as the **vector** of contamination, can be used to trace the contaminant back to its site of origin using simple deduction. By observing how a contaminant affects The mushroom crop and by carefully noting the conditions in which it flourishes, a cultivator can soon identify its cause.

Earlier in the book, the five most probable vectors of contamination were identified as:

1. The cultivator.
2. the air.
3. the substrate to be inoculated.
4. the mycelium that was being transferred.
5. the inoculating tools, equipment, containers, facilities, etc.

Different contaminants are associated with different stages of mushroom cultivation. Contaminants in agar culture most often come from airborne spores. Grain cultures contaminate from airborne spores and from a source which many cultivators fail to identify: The grain used in spawn making which is laden with spores of imperfect fungi, yeasts and bacteria. (See Ivanovich-Biserka, 1972). In compost culture, the major contributors to contamination are the materials used, the spawn, the workers or The facilities. This is not to say that contaminants can not be introduced by other means; these are the most probable sources of contamination given the cultivator has followed generally accepted procedures for mushroom culture.

Tracking down the source of contamination is not difficult. For instance, the photographs below show two media filled petri dishes contaminated with a *Penicillium* mold. Although the contaminant may be the same, the source of contamination is likely to be quite different. The plate in Fig. 174 has a mold colony growing directly beside the wedge of mycelium that was transferred. The plate in Fig. 175 shows contamination along the outer periphery. Here is a clear example illustrating how contamination spreads.

The left plate became contaminated when the mycelium was transferred, suggesting the mold was associated with the previous culture. The right petri dish contaminated from airborne spores which entered as the culture was incubating, judging by the proximity of the mold colonies to the outer edge. Air movement within the "sterile" laboratory most likely wafted spores towards the media plate and some penetrated the minute spaces between the lid and the base. Within the still air environment of the petri dish, spores settled nearest to their point of entry, germinated and began respirulating, soon to be visible as a green mold. One would, therefore, implement the measures of control accordingly.

Often times the source of contamination is not obvious. Beginners are at a particular disadvantage because every contaminant they encounter is "new". With each crop, problems arise requiring novel solutions. If a certain method of cultivation has been repeatedly successful in the past and sud-

---

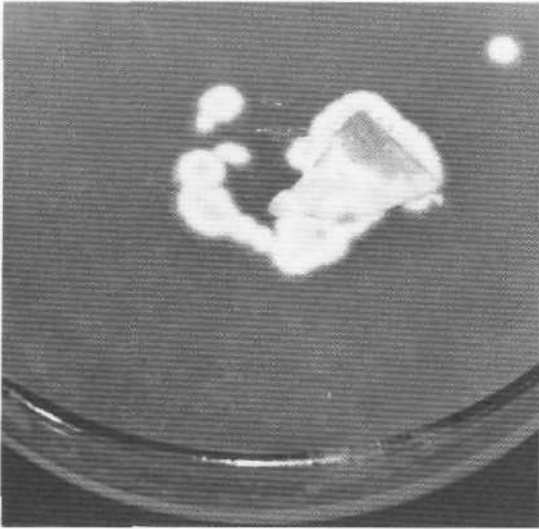

**Figure 174** *Penicillium* mold near to transferred wedge of mushroom mycelium.

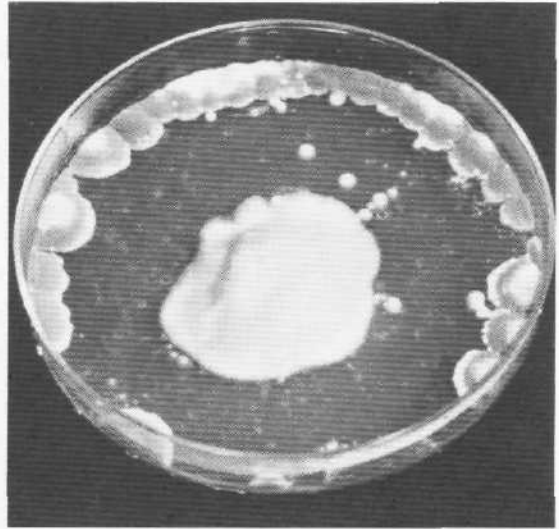

**Figure 175** *Penicillium* mold along outer periphery of petri dish.

denly an unfamiliar contaminant appears, identifying the vector can be much more difficult. **Only** when The cultivator can pinpoint the variables leading to the introduction of that contaminant can appropriate counter-measures be applied. Frequently what seems to be an inconsequential alteration in technique at one stage leads to a radical escalation of the contamination rate at later stages.

**Since** contamination at any phase of cultivation occurs for specific reasons, the contaminants can be the cultivator's most valuable guide for teaching one what NOT to do. If the problem causing organism is identified and if the recommended measures of control are carefully followed, a conscientious cultivator will avoid those conditions predisposing to that one competitor and, incidentally, many **others**. In effect, skill in mushroom culture is tantamount to skill in contamination control.

Molds and bacteria do not grow well in a climate specifically adjusted for mushrooms. Although both mushrooms and contaminants prefer humid conditions, the latter thrive in prolonged stagnant air environments whereas mushrooms do not. The differences are frequently subtle—amounting to only a few percentage points in relative humidity and slight adjustments to the air intake dampers in the growing room.

The contaminants can be divided into two well defined groups. Those attacking the mushrooms are called **pathogens** while Those competing for The substrate are labeled **indicators or competitors**. (Mushroom pathogens are either molds, bacteria, viruses or pests; indicators are always fungi of some sort). In general, mushroom pathogens are not as numerous as the competitor molds, though they can be much more devastating.

Not all molds and bacteria are damaging to the mushroom crop. To the contrary, several are beneficial. **These can** not be called true "contaminants" since cultivators try to promote, not hinder,

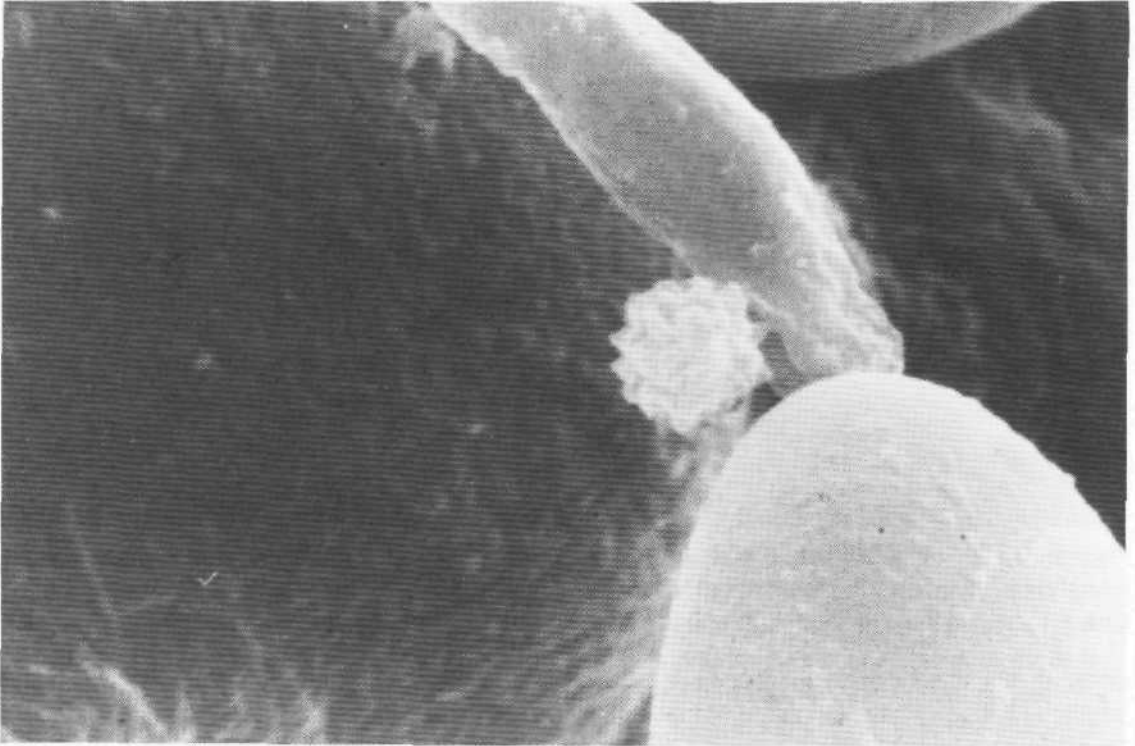

**Figure 176** High magnification scanning electron micrograph of *Aspergillus* spore beside germinating spore of *Psilocybe cubensis*.

their growth. To the beginner, however, they resemble real contaminants and therefore must be included in this chapter. Examples of yield enhancing organisms are several thermophilic fungi and bacteria, including:

*Humicola*

*Torula*

*Actinomyces*

*Streptomyces*

Select *Pseudomonas* and *Bacillus* species

These organisms are encouraged during the preparation of compost or during spawn run and are rarely seen in agar or grain culture. Since they can not accurately be termed contaminants, the aforementioned groups are not in the following key though they are fully discussed in the ensuing descriptions.

Fungi, bacteria and viruses can be roughly delimited according to their size. All but viruses can be detected by the home cultivator. Viruses can prevent fruiting, malform the mushroom fruitbody, and expose the crop to further infestations from other pathogens. Since detecting viruses is beyond the means of home cultivators, they have also been excluded from this key.



**RELATIVE SIZES OF THE CONTAMINANT GROUPS**

Organism	Size (in microns)	Method of Detection
Viruses	.01—.20	X-ray defraction, transmission electron microscopy and ultracentrifuge. Typically attached to other larger particles, occurring within cells, or are present in large conglomerate colonies. Often associated with bacteria.
Bacteria	.40-5.0	Detected by electron microscopy, light microscopy and ultracentrifuge. Large colonies visible to unaided eye. Sometimes associated with mushroom spores or mycelium.
Fungi	2.0-30.0	Detected by light microscopy. Large colonies visible to unaided eye. Associated with a larger spore generating structure, often chain-like in form.

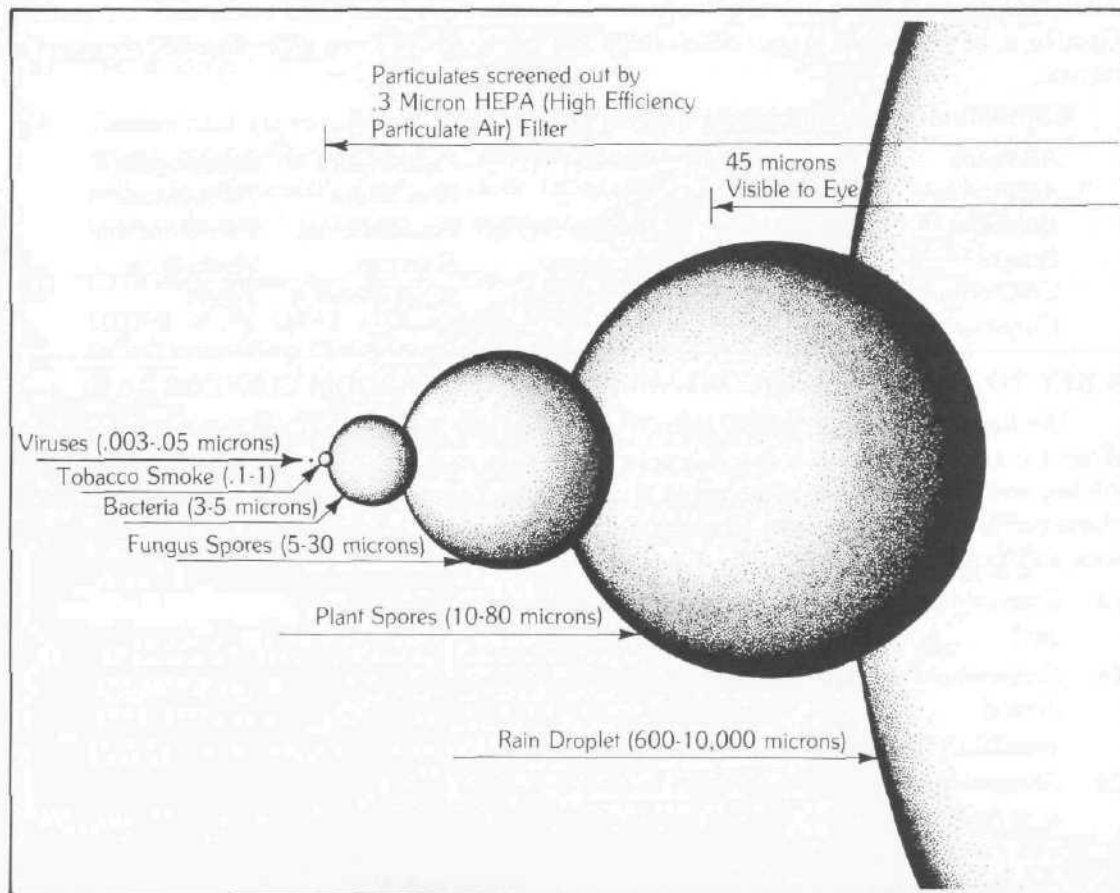

Figure 177 Diagram illustrating comparative sizes of airborne particulates.

What follows is a rudimentary key to the major contaminant groups encountered in mushroom cultivation with the exception of insects and viruses which are discussed in later sections. Though thousands of species of fungi exist in nature, only a small fraction are repeatedly seen in the course of mushroom culture. Hence, This key is limited to that small sphere of microorganisms and does not propose To be an all encompassing guide to the molds. Nevertheless, this key should prove to be a valuable resource for anyone interested in improving their cultivation skills. Some contaminants are keyed out more than once if occurring in various habitats, or if exhibiting significant color changes. Since color has some emphasis in this key and that feature can be substrate specific, the authors presume the agar medium employed is 2% malt based, the spawn carrier is rye grain or sawdust/bran, and the fruiting substrate is one outlined in this book.

Once led to a particular genus, refer to its description. If in doubt, a quick look under a medium power (400 X) microscope should readily discern one contaminant from another. If the contaminant can be identified but its source can not, turn the chapter entitled Cultivation Problems and Their Solutions. One or more of the common names have been listed under each competitor. Good luck, be meticulous in your observations and strictly adhere to the recommended measures of control.

#### Contaminants encompassed by this key:

<i>Alternaria</i>	<i>Cladosporium</i>	<i>Monilia</i>	<i>Papulospora</i>	<i>Sepedonium</i>
<i>Aspergillus</i>	<i>Coprinus</i>	<i>Mucor</i>	<i>Penicillium</i>	<i>Trichoderma</i>
<i>Bacillus</i>	<i>Dactylium</i>	<i>Mycelia Sterilia</i>	<i>Pseudomonas</i>	<i>Trichothecium</i>
<i>Botrytis</i>	<i>Epicoccum</i>	<i>Mycogone</i>	<i>Rhizopus</i>	<i>Verticillium</i>
<i>Chaetomium</i>	<i>Fusarium</i>	<i>Neurospora</i>	<i>Scopulariopsis</i>	Yeasts
<i>Chrysosporium</i>	<i>Geotrichum</i>			

### A KEY TO THE COMMON CONTAMINANTS IN MUSHROOM CULTURE

This key is easy to use. Simply follow the key lead That best describes the contaminant at hand. When the key terminates at a specific contaminant, turn to the descriptions immediately following this key and then refer to the photographs and any related genus mentioned. To confirm the identity of any contaminant, compare its sporulating structures with the accompanying microscopic illustrations and/or micrographs.

- 1a Contaminant parasitizing the mushroom fruitbody (a pathogen) . . . . . 2
- 1b Contaminant not parasitizing the mushroom fruitbody (an indicator) . . . . . 7
- 2a Contaminant causing mushrooms to become watery, slimy, or to have lesions from which a liquid oozes but not covered with a powdery or downy mycelium. . . . . 3
- 2b Contaminant not as above but covering mushrooms with a fine powdery or mildew-like mycelium. . . . . 4

- 3a Droplets forming across the cap and stem but lacking sunken lesions. Mushrooms eventually reduced to a whitish foam-like mass. . . . . Causal organism not known  
"Weepers"
- 3b Cap not as above but first having brownish spots that enlarge, deepen, and in which a grayish brown slime forms. Mushrooms eventually disintegrate into a dark slimy, oozing mass . . . . . *Pseudomonas tolassii*  
Bacterial Blotch  
Bacterial Pit
- 4a Contaminant eventually sporulating as a green mold on the mushroom. Usually preceded by an outbreak of green mold on the casing layer. . . . . *Trichoderma viride*  
*Trichoderma koningii*  
"Trichoderma Blotch"
- 4b Not as above. . . . . 5
- 5a Contaminant appears on the casing soil as a fast running grayish cobweb-like mycelium, enveloping mushrooms in its path. (Spores usually three or more celled and 20 x 5 microns in size. If two celled, not acorn-shaped). . . . . *Dactylium dendroides*  
"Cobweb Mold"
- 5b Contaminant attacking the mushroom but usually not appearing on the casing layer. (Spores single celled or if two celled, resembling a roughened acorn and measuring much less than above). . . . . 6
- 6a Contaminant turning young mushrooms into a rotting amorphous ball-like mass from which an amber fluid oozes upon cutting. Stem typically not splitting or peeling. (Spores one and two celled, the latter being darkly pigmented and acorn-shaped). . . . . *Mycogone perniciosa*  
"Wet Bubble"
- 6b Contaminant afflicting young mushrooms as described above but those parasitized not exuding amber fluid when cut open. Stem in more mature mushrooms often splitting and peeling, causing the mushrooms to tilt. (Spores one celled). . . . . *Verticillium malthousei*  
"Dry Bubble"
- 7a Contaminant in the form of another mushroom whose cap deliquesces (melts) into a blackish liquid with age. . . . . *Coprinus spp.*  
"Inky Cap"

- 7b Contaminant not as above. . . . . 8
- 8a Contaminant becoming pinkish to reddish to purplish colored in age. . . . . 9
- 8b Contaminant not as above. . . . . 14
- 9a Occurring on compost or the casing layer. . . . . 10
- 9b Occurring on nutrient agar media and on grain. . . . . 11
- 10a Mycelium fast growing, aerial, and never having a frosty texture. Pinkish with spore maturity. (Spores unicellular with nerve-like ridges longitudinally arranged and ellipsoid) . . . . *Neurospora* sp.  
"Pink Mold"
- 10b Mycelium slow growing, appressed, and developing a frosty texture. Often becoming cherry red. (Spores cylindrical and lacking nerve-like ridges) . . . . . *Geotrichum* "Lipstick Mold"
- 11a Mycelial network of contaminant not well developed, not clearly visible to the unaided eye, often slime-like. . . . . 12
- 11b Mycelial network of contaminant well defined and easily discernible to the naked eye, not slime like. . . . . 13
- 12a More frequently seen in agar culture. (Spores produced by simple budding, ovoid, single celled) . . . . . The Yeasts  
see *Cryptococcus*
- 12b More frequently seen in grain culture. (Spores produced on a short conidiophore, sickle shaped, and multicelled) . . . . . *Fusarium*  
"Yellow Rain Mold"
- 13a Mycelium fast growing and aerial. (Spores with nerve-like ridges and ellipsoid). . . . . *Neurospora*  
"Pink Mold"
- 13b Mycelium typically slow growing and appressed. (Spores two celled, without ridges, and pear-shaped). . . . . *Trichothecium* sp.  
"Pink Mold"
- 14a Contaminant slime-like in form. . . . . 15
- 14b Contaminant mycelium-like or mold-like in form. . . . . 17
- 15a Non-motile (not moving spontaneously). Spores relatively large, 4-20 microns in diameter. Not affected by bacterial antibiotics such as gentamycin sulfate. . . . . The Yeasts  
(see *Cryptococcus* and *Rhodotorula* under *Torula*)

- 15b Motile (moving spontaneously). Spores relatively minute, rarely exceeding 2 microns in diameter. Growth prevented by bacterial antibiotics such as gentamycin sulfate. . . . . 16
- 16a Cells rod-like in shape. Gram positive (retaining a violet dye when fixed with crystal violet and an iodine solution) . . . . . *Bacillus*  
"Wet Spot"
- 16b Cells variable in shape. Gram negative (not retaining a violet dye when fixed with crystal violet and an iodine solution) . . . . . *Pseudomonas*  
"Bacterial Blotch"
- 17a Contaminant mold greenish with spore maturity. . . . . 18
- 17b Contaminant mold blackish with spore maturity. . . . . 20
- 17c Contaminant mold brownish with spore maturity. . . . . 24
- 17d Contaminant mold yellowish with spore maturity. . . . . 25
- 17e Contaminant mold whitish with spore maturity. . . . . 28
- 18a Forming small burrs and usually olive green in color. (Spores lemon shaped, enveloped in a sac-like structure (a perithecium). . . . . *Chaetomium olivaceum*  
"Olive Green Mold"
- 18b Not as above. . . . . 19
- 19a Molds typically blue-green in color. (Conidiophore diverging at apex into multiple chains of lightly pigmented single celled spores). . . . . *Penicillium* spp.  
"Blue Green Mold"
- 19b Molds typically true green to yellow green in color. (Conidiophore swollen at apex and bulb-like (capitate), around which multiple chains of lightly pigmented single celled spores extend). . . . . *Aspergillus* spp.  
"Green Mold"
- 19c Molds forest green in color. (Conidiophore easily disassembling in wet mounts and difficult to observe under the microscope. Spores single celled, lightly pigmented, and encased in a mucous-like substance). . . . . *Thchoderma* spp.  
"Forest Green Mold"
- 19d Molds blackish green in color. (Conidiophores branching into few forks at whose ends darkly pigmented spores form, often two celled.) . . . . . *Cladosporium* spp.  
"Blackish Green Mold"

- 
- 20a Mold colony appressed, resembling a dark *Penicillium*-like mold, but not aerial. . . . . 21
- 20b Mold colony aerial, not *Penicillium*-like . . . . . 22
- 21 a (Spores elongated and ornamented with ridges, generally exceeding 20 microns in length and 5 microns in diameter) . . . *Alternaria* spp.  
"Black Mold"
- 21 b (Spores spherical, not ornamented with ridges, generally less than 5 microns in diameter). . . . . *Aspergillus* spp.  
"Black Mold"
- 22a Most frequently seen on compost. Resembling black whiskers. (Forming a conidiophore that diverges into multiple stalks at whose ends are chains of darkly pigmented spores). . . . . *Doratomyces stemonitis*  
"Black Whisker Mold"
- 22b Most frequently seen in agar and grain culture. Resembling a forest of dark headed pins. (Forming a sporangiophore consisting of single stalk at whose end a ball-like sporulating structure is attached). . . . . 23
- 23a Conidiophore appearing swelled at apex; partially covered by a sporulating membrane. . . . . *Rhizopus*  
"Black Bread Mold"  
"Black Pin Mold"
- 23b Conidiophore not swelled as above; apex totally covered by sporulating membrane. . . . . *Mucor*  
"Black Pin Mold"
- 24a Mold developing small bead-like masses of cells (easily visible with a magnifying lens). Never producing cup-like fruitbodies. (Darkly pigmented cells clustered on a mycelial mat; spores lacking). . . . . *Papulospora byssina*  
"Brown Plaster Mold"
- 24b Mold not developing the ball-like clusters of the above. Sometimes producing cup-like fruitbodies. (Spores produced in bunches in a grape-like fashion). . . . . *Botrytis* "Brown Mold"
-

- 25a Mold forming a corky layer between the casing layer and the compost, and mat-like. (Spores borne on short vase shaped pegs). . . . . *Chrysosporium luteum*  
"Yellow Mar Disease"  
"Confetti"
- 25b Mold not forming a corky layer and appearing mat-like. (Spores not borne in The manner above). . . . . 26
- 26a Not occurring on compost. (Conidiophores short, arising from cushion shaped cells. Spores, if reticulated, appear to be composed of several tightly compacted cells). . . . . *Epicoccum*  
"Yellow Mold"
- 26b Frequently seen on compost but not exclusively so. (Conidiophores not as above. Spores appearing unicellular) . . . . . 27
- 27a Spores large, exceeding 5 microns in diameter, and of two types. Some spherical and spiny, forming singly at the end of individual hyphal branches; others vase shaped arising singly or in loose clusters from an indistinct, hyphal-like conidiophore). . . . . *Sepedonium*  
"Yellow Mold"
- 27b Spores small, less than 5 microns in diameter, ovoid, forming on chains arising from a head-like structure positioned at the apex of a long stalk. . . . . *Aspergillus* spp.  
"Yellow Mold"
- 28a Appearing as a dense plaster-like or stroma-like mycelium. (Conidiophore brush shaped (pencilate)) . . . . . *Scopulariopsis*  
"White Plaster Mold"
- 28b Mycelium not plaster-like. (Conidiophore not brush shaped (pencilate)). . . . . 29
- 29a Spores forming from hyphae in chains. . . . . *Monilia*  
"White Flour Mold"
- 29b Spores absent, not forming from hyphae. . . . . *Mycelia Sterilia*  
(see also: *Mucor* and *Sepedonium*).

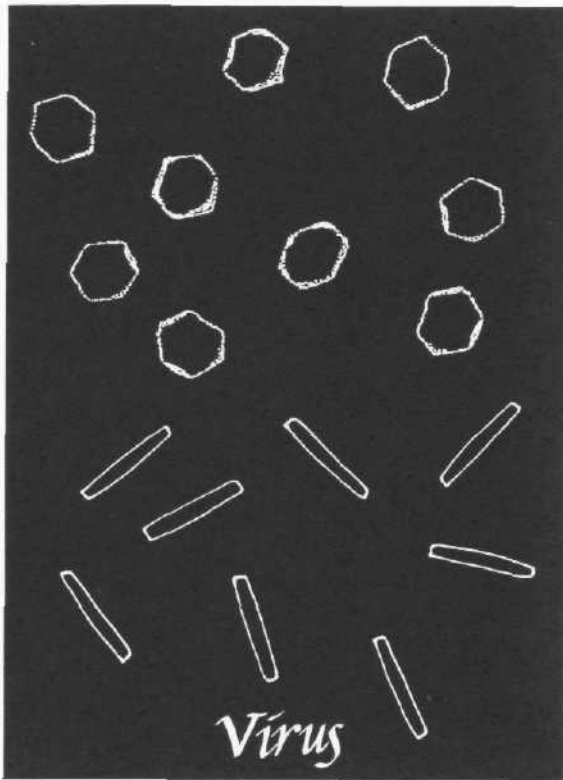

## VIRUS

**Common Name:** Die-back Disease; La France Disease, Mummy.

**Habitat and Frequency of Occurrence:** An infrequent and difficult to detect disease. Their habitats are other larger particles or organisms.

**Medium through which contamination is spread:** Primarily from infected mycelium or from the spores of diseased mushrooms. Dieleman-van Zaayen (1972) found that the most common way virus spreads is through the anastomosing ("merging") of healthy mycelia with infected mycelia that was left-over from previous crops. Once anastomosed, the virus particles spread throughout the mycelial network of the new mycelium.

**Measures of Control:** Thorough disinfection of the growing room between crop rotations by steam heating for 12 hours at 158-160° F.; the installation of high efficiency spore filters to screen particulates exiting the growing environment; the disinfection of floors and hallways leading to and from the growing room with 2% chlorine solution; and picking diseased mushrooms while the veil is intact before spores have the opportunity to spread. Isolation of infected crops from adjacent rooms or those newly spawned helps retard the spread of this disease. Other measures of control include the placement of disinfectant floor mats to prevent the tracking in of virus-carrying particles on worker's shoes and the maintenance of strict hygienic practices at all times, particularly between crops.

**Macroscopic Appearance:** On nutrient agar media, infected mycelia slows or nearly abates in its rate of growth as the disease progresses throughout the mycelial network. When running through the casing layer, large zones one to three feet in diameter remain uncolonized. In some cases the mycelia, once present, disappears from the surface. Fruitbodies may not form at all, or when they do, the mushrooms are typically deformed (dwarfed or aborted), often with watery or splitting stems, and brown rot. The caps prematurely expand to plane. Virus infected cultures can exhibit any combination of the above described symptoms.

**Microscopic Characteristics:** Particles typically ovoid to polyhedral, measuring 25 or 34 nanometers. Elongated particles measure 19-50 nanometers. Virus particles dwell within hyphal cells or



on the surfaces of spores. They are detectable only through transmission electron microscopy or ultracentrifuging.

**History, Use and/or Medical Implications:** Responsible for many plant, animal and human diseases. Typically viruses are associated with larger carrier particles, particularly bacteria.

**Comments:** Virus is most likely introduced during or directly after spawning. Infected farms experience losses up to 70%. First reported from Europe, measures of control and prevention have been developed and successfully tested by the Dutch. Most notably, virus spreads by attaching itself to mushroom spores which then become airborne. Virus also spreads through the contact of healthy mycelia with diseased mycelia. Afflicted mushrooms are soon exploited by a host of other parasites, making a late and accurate diagnosis of this contaminant difficult.

Undoubtedly, virus is the cause of what many have noted as "strain degeneration". Heat treatment of infected strains grown on enriched agar media at 95 ° F. for three weeks has been suggested as one remedy for curing diseased mycelia. (See Gandy and Hollings, 1962 and Rasmussen et al., 1972).

Van Zaayen (1979) and others have noted that *Agaricus bitorquis* seems resistant to virus disease even when inoculated with in vitro particles. Another species of *Agaricus*, called *Agaricus arvensis*, exhibits similar virus resistant qualities.

Virus-like particles have also been found in *Lentinus edodes* by Mori et alia (1979) but do not adversely affect fruitbody formation or development. These same researchers reported that this species' viruses can not be transmitted to other mushrooms or plants, a fact they attributed to the interferon producing properties of the shiitake mushroom. No work with infected strains of *Psilocybe* are known. Only a fraction of wild mushrooms harbor virus-like particles.

---

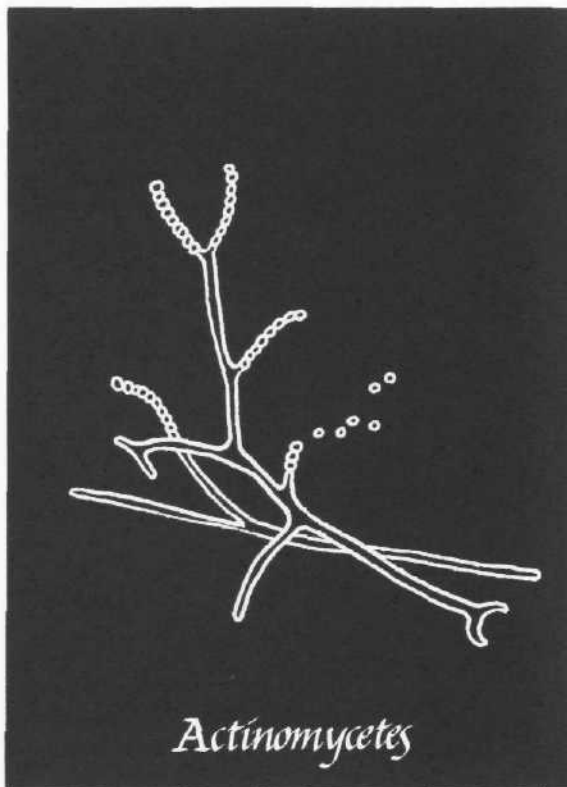

*Actinomycetes*

Figure 178 Drawing of *Actinomycetes*.

## ACTINOMYCES

**Class:** *Actinomycetes*

**Order:** Actinomycetales

**Family:** Actinomycetaceae

**Common Name:** Firefang.

**Greek Root:** From “actino” meaning rayed or star-like and “myces” or fungus, in reference to its characteristic appearance when colonizing straw or straw/manure compost.

**Habitat & Frequency of Occurrence:** Many species thermophilic; thriving in the 115-135°F. temperature range and commonly found in decomposing straw, horse and cow manures. *Actinomycetes* are important soil constituents. They thrive in aerobic, well prepared mushroom composts.

**Medium Through Which Contamination Is Spread:** Primarily air; secondarily the straw used in compost preparation.

**Measures of Control:** Generally no controls are necessary during compost preparation. However, *Actinomycetes* can cause spontaneous combustion in wet, compacted straw. Covering stored baled straw from excess water absorption should be adequate protection from *Actinomycetes* and the thermogenic reactions they cause.

**Macroscopic Appearance:** Grayish To whitish speckled colonies, readily apparent on dark composted straw.

**Microscopic Characteristics:** Composed of an extensive, fine hyphal network that rarely branches. Rod-like spores form when the filaments break at the cell wall junctions. The filamentous hyphae and spores are minute, measuring only 1 micron in diameter. Within each cell, no well defined nucleus is discernible. Lacking differentiated spore-producing *bodies*, *Actinomycetes* are Gram-positive.

**History, Use, and/or Medical Implications:** Few species pathogenic. Amongst agricultural workers in the same position, males are three times more susceptible to this bacterium than females (see Cruickshank et al., 1973). Two notable species causing serious diseases (actinomycosis) of the skin and oral cavity in humans are *Actinomycetes bovis* and *Actinomycetes israelii*. Generally, these

species behave as secondary infectious organisms. Penicillin is often used for treatment. Actinomycin, a potent antibiotic compound interfering with RNA synthesis, is derived from this group of bacteria.

Although the likelihood of mushroom growers contracting actinomycosis is remote, workers spawning compost are exposed to high concentrations of *Actinomyces* spores and often report less severe, temporary allergic reactions. Therefore, the use of a filter mask when spawning large volumes of compost is advisable.

**Comments:** The *Actinomyces* resemble both bacteria and fungi and have alternately been called one or the other. Presently, the prevailing belief is that they are filamentous (Gram-positive) bacteria because they are prokaryotic (lacking a defined nucleus), are inhibited by bacterial antibiotics and not affected by fungal antibiotics; and lack the chitin-like compounds so typical of the true fungi. The hyphal filaments of *Actinomyces* are one fifth to one tenth as thick as those of true fungi.

*Actinomyces* are commonly called Firefang for their ability to cause spontaneous combustion of decomposing materials. (Spontaneous combustion is prevented by proper composting practices.) Many of these bacteria/fungi are true thermophiles and can live aerobically or anaerobically. *Actinomyces* is the major microorganism selected to colonize the compost during Phase II. When the finished compost is spawned, *Actinomyces* are consumed by the mushroom mycelia. See also *Streptomyces*. See Color Photo VIII.

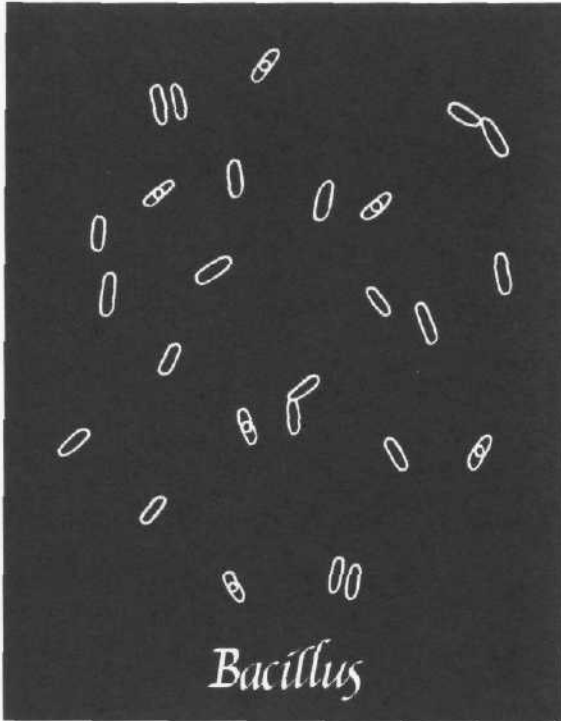

**Figure 179** Drawing of endospore forming *Bacillus* cells as they appear through a microscope and without special stains.

**Measures of Control:** Air filtration through high efficiency Particulate air filters; thorough sterilization of grain; and proper storage and use of relatively "clean" grains. The addition of antibiotics to agar media (gentamycin sulfate, penicillin, streptomycin, aureomycin, etc.) hinders or prevents the growth of these contaminants. Endospores are neutralized by exposure to moist heat, such as the steam generated within a pressure cooker at temperatures of 250 °F. and 15 psi pressure for a full hour. Temperatures as low as 140 °F. kill the vegetative parent cells but not the endospores they form.

**Macroscopic Appearance:** A dull gray to mucus-like brownish slime characterized by a strong but foul odor variously described as smelling like rotting apples, dirty socks or burnt bacon. *Bacillus* makes uncolonized grain appear *excessively* wet, hence the name "Wet Spot". Pallid to whitish ridges along the margins of individual grain kernels characterize this contaminant.

**Microscopic Characteristics:** Rod-like or cylindrical in shape, measuring 0.2-1.2 microns in diameter and 1-5 microns in length. When wet mounts are viewed through a microscope, *Bacilli* excitedly wriggle back and forth. Species move by the vibrating action of flagella ("hairs") that outline each cell. These flagella are difficult to observe microscopically without using specific staining techniques, *Bacilli* are encapsulated by a thin but firm slime and conglomerations of cells give infected

## BACILLUS

Class: *Schizomycetes*

Order: *Eubacteriales*

Family: *Bacillaceae*

**Common Name:** Wet Spot; Sour Rot.

**Latin Root:** From "bacilliformis" meaning rod-like, in reference to its characteristic shape.

**Habitat & Frequency of Occurrence:** Living within a broad range of habitats. *Bacillus* grows on almost anything organic that is moist and is surrounded by oxygen. It is particularly common in soils.

**Medium Through Which Contamination Is Spread:** Primarily through the air; secondarily through water, grain, soils, composts, insects, tools and workers.

Figure 180 *Bacillus*, the Wet Spot bacterium, as it appears on grain.

Figure 181 Scanning electron micrograph of rod shaped bacteria on a spore of *Panaeolus acuminatus*.

Figure 182 Scanning electron micrograph of rod shaped bacteria on mycelium of *Psilocybe cubensis*.

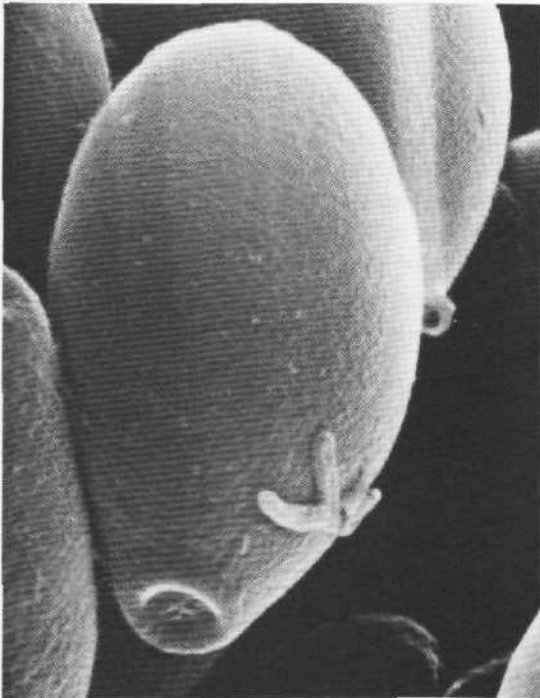

grain a slimy appearance. *Bacillus* primarily reproduces through simple cell division. In times of adverse environmental conditions, especially heat, a single hardened spore forms within each parent cell body. These endospores show an extraordinary resistance to heat, are low in water content and are unaffected by drying. Species in this genus are Gram positive.

**History, Use, and/or Medical Implications:** The most notable species in the genus is *Bacillus anthracis*, the cause of the hideous Anthrax disease that killed several thousand sheep when an United States Army experiment went awry in Utah during the 1950s. Home cultivators are, however, unlikely to be exposed to this species. Most endospore forming bacteria are not virulent. *Bacillus subtilis*, the bacterium spoiling grain spawn, is being developed To replace *E. coli* as a recombinant-DNA fermentor. *Clostridium* is a genus similar to *Bacillus* except That it is anaerobic. That genus is reknowned for one toxic species in particular: *C. botulinum*, the cause of botulism.

**Comments:** A pernicious and tenacious competitor, *Bacillus* contamination is the most difficult to control. At room temperature, a single cell reproduces every 20 minutes and will multiply into nearly a million daughter bacteria in only seven hours. In another seven hours each one of those million bacteria divide into a million more cells. Thus, in less than fourteen hours, one trillion bacteria evolve from a single parent cell!

The phenomenal reproductive capability of *Bacillus* and other bacteria poses a formidable threat to the spawn maker. Although parent cells are easily destroyed, their endospores are not. Under dry conditions, endospores form in increasing numbers as temperatures rise to 130 ° F. In boiling water (212 ° F.), endospore viability markedly decreases. (Ninety percent of *Bacillus* spores are killed in only one minute at 212 ° F.). At the higher temperatures and pressures within an autoclave the survivability of *Bacillus* spores falls well below 1 %. Nevertheless, this 1 % seriously obstructs any attempt at grain culture given *Bacillus'* rapid reproductive capability. This problem is compounded if the bacteria count in the grain is initially high.

In one study (Shull and Ernst, 1962), the thermal death time (TDT) of an exposed *Bacillus stearothermophilus* population of 1,300,000 endospores was pinpointed at 250°F. for 13 minutes. (In a pressure cooker at sea level, 250°F. corresponds to 15 psi). Food researchers concerned with food-spoiling bacteria (particularly *Clostridium*) have shown that endospore endurance to heat is directly related To the amount of calcium in the host substrate. Once formed, endospores can sit dormant for extended periods of time. Even endospores removed from the stomachs of mummies have proved viable after hundreds of years.

Although an autoclave may read a certain Temperature, the grain within the spawn containers may be well below that reading. To guarantee adequate steam penetration, the water in pressure cookers should be brought to a boil for 5 minutes before closing the vent valve. Furthermore, bacteria within the spawn container are partially protected from the sterilizing influence of steam by the structural cavities of the grain medium. This delay in steam penetration time is especially characteristic of large, heavily packed autoclaves.

Despite the fact that autoclaving for one hour at 15 psi is sufficient to kill most contaminants, grain having initially high bacteria populations may require sterilization at higher temperatures and for prolonged periods of time. Autoclaving quart jars for 1 hour at 270 ° F. (which is equivalent to

---

27 psi) is sufficient to neutralize grain heavily infested with endospore forming bacteria. If converting a standard home pressure cooker for this purpose, contact the manufacturer about stress limitations and follow all safety recommendations.

If sterilized rye grain spontaneously contaminates with bacteria before inoculation and the grain is the cause, it is best to replace the grain with a cleaner one than to undergo the expense and time of double sterilization. Some spawn laboratories regularly precook their grain for approximately 2 hours in water at a low boil. Excess water is allowed to drain from the grains which are then placed into the spawn container and sterilized at standard time and pressure.

The most practical method for eliminating bacterial endospores involves soaking the grain at room temperature 24 hours prior to sterilization. Endospores, if viable, will germinate within that time frame and then be susceptible to standard sterilization procedures. And, new endospores won't form in the moist environment of the resting jar of grain.

*Bacillus subtilis* var. *mucooides* is the common bacterium responsible for spoiling spawn media. If allowed to proliferate, this contaminant wreaks havoc in a spawn laboratory, necessitating a complete shut-down of operations. Spores and even strains of mushroom mycelium can become hosts for *Bacillus*, carrying bacteria on their hyphae (see Figs. 181 & 182), and then contaminating any media onto which the mushroom mycelia is transferred.

Many bacteria are rod-shaped and the term bacillus has been loosely used to describe them. The genus concept of *Bacillus*, however, has been narrowed considerably with time; *Bacillus* is now defined as Gram positive rod-like, aerobic bacteria that form spores.

According to Park and Agnihotri (1969), *Bacillus megaterium* stimulates primordia formation in certain strains of *Agaricus brunnescens* (*bisporus*). (See Appendix II for a further discussion on the influence of bacteria on fruiting). Another species, *Bacillus thermofibricolous*, if introduced at spawning, inhibits the growth of competitor molds in rice bran/sawdust spawn prepared for shiitake cultivation according to Steineck (1973).

See Also *Pseudomonas*.

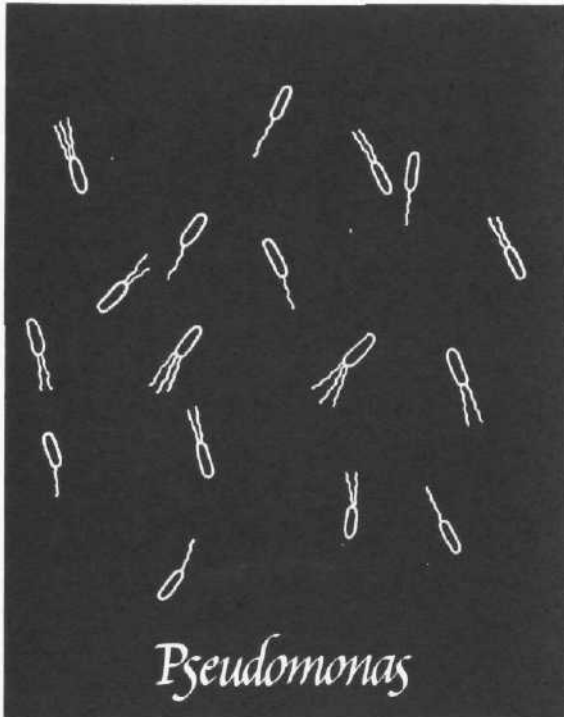

**Figure 183** Drawing of *Pseudomonas*, a genus of variably shaped bacteria that have hair-like flagella at their ends.

## PSEUDOMONAS

**Class:** *Schizomycetes*

**Order:** *Pseudomonadales*

**Family:** *Pseudomonaceae*

**Common Name:** Bacterial Blotch; Bacterial Pit.

**Greek Root:** From “pseudes” meaning spurious, false or deceptive and “monas” meaning one or a single unit, in reference to the variable forms of this single celled bacterium.

**Habitat & Frequency of Occurrence:** Ubiquitous in all soils and abounding in aqueous habitats. *Pseudomonas tolaasii* commonly parasitizes mushrooms that remain wet over a prolonged period of time.

**Medium Through Which Contamination Is Spread:** Primarily water; secondarily through grain, soils, composts, flies, mites, nematodes, tools and workers.

**Measures of Control:** Use of mildly chlorinated water (150-250 ppm) or water free of high bacteria counts. This contaminant can easily be prevented by: isolating and properly disposing of infected fruitbodies; eliminating excessively high humidity levels during cropping (greater than 92%); and preventing stagnant air pockets through a good air circulation system. Maintaining a sufficient evaporation rate lessens the likelihood of these bacteria infecting the fruitbodies.

**Macroscopic Appearance:** Yellowish spots or circular or irregular lesions; superficial; rapidly reproducing on wet mushrooms; and becoming chocolate brown and slimy with age. This bacterium has a dull gray to mucus-like brownish slime. It also has a mildly to strongly unpleasant odor.

**Microscopic Characteristics:** Cylindrical (bacilli) and spherical (cocci) forms characterize this genus. Cells are extremely variable in shape, measuring 0.4-0.5 x 1.0-1.7 microns. Typically the bacterial cell has one or more flagella (“motile hairs”) at one or both of its poles. (*Bacillus* has flagella along its entire outer periphery). Both organisms use these flagella for locomotion. Species in



Figure 184 *Pseudomonas putida*, a beneficial bacterium stimulatory to formation of fruitbodies in some mushroom species, growing on malt agar.

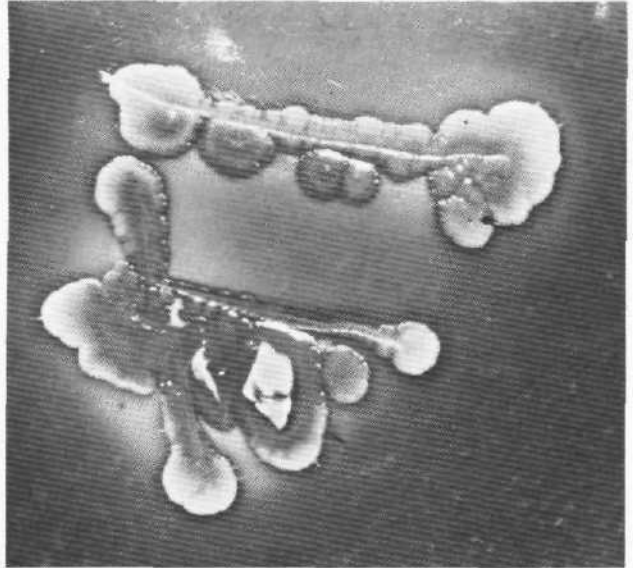

Figure 185 Bacterial pit on *Psilocybe cubensis* from a *Pseudomonas* species.



this genus are generally Gram negative.

**History, Use and/or Medical Implications:** Some species pathogenic to humans. Of special note is *Pseudomonas aeruginosa* (also known as *Ps. pyocyanea*), a species that causes blindness and other diseases. *Pseudomonas putida* is stimulatory to primordia formation in certain strains of *Agaricus brunnescens* (*bisporus*) and its use is of potential commercial value.

**Comments:** More than 140 species have been identified thus far; only a few have been identified as affecting mushrooms. *Pseudomonas* species are much more sensitive to heat sterilization than the endospore-forming bacilli. *Pseudomonas* bacteria proliferate in standing water or anywhere there is moisture.

*Pseudomonas tolaasii* is the cause of bacterial blotch that can devastate crops of *Agaricus* and *Psilocybe*. One biological remedy for controlling this species was proposed by Nair and Fahy (1972) who showed that introduction of *Pseudomonas fluorescens*, a natural antagonist to *Pseudomonas tolaasii*, markedly decreased the occurrence of blotch while not hindering *Agaricus brunnescens* yields. Others believe *Pseudomonas fluorescens* to be merely a variety of *Pseudomonas tolaasii*, and hesitate to recommend it.

In a characteristic manner, *Pseudomonas tolaasii* causes sunken grayish brown lesions on the mushroom cap in which a slimy fluid collects. Another *Pseudomonas* species, yet unidentified, has been implicated in the cause of a more severe form of blotch, Bacterial Pit.

*Pseudomonas* also contaminates agar and grain cultures, inhibiting mycelial growth. The use of antibiotics (gentamycin sulfate) or micron filters prevents outbreaks of this contaminant. A few species cause the mycelium to grow more rapidly and luxuriantly. Similarly, considerable attention has centered on the beneficial role of *Pseudomonas putida* and allies in the casing layer. This subject is discussed in detail in Appendix II.

See also *Bacillus*.

## STREPTOMYCES

**Class:** *Actinomyces*

**Order:** *Actinomycetales*

**Family:** *Streptomycetaceae*

**Common Name:** Firefang.

**Greek Root:** From "strepto" meaning twisted and "myces" or fungus, in reference to the twisting and branching filaments that give rise to spores.

**Habitat & Frequency of Occurrence:** Ubiquitous on straw, manures and soil. *Streptomyces* is a predominant microorganism in the compost pile, thriving between 115-135°F. and preferring aerobic zones.

**Medium Through Which Contamination Is Spread:** Primarily air; secondarily from materials used in composting. *Streptomyces* are naturally present in all soils.

**Measures of Control:** Generally no controls are necessary during compost preparation, nor desired. General hygienic practices prevent this bacterium from becoming a problem contaminant in the laboratory.

**Macroscopic Appearance:** Grayish to whitish specked colonies, readily apparent on composted straw. On grain, *Streptomyces* has a delicate whitish mycelium and is powdery in form.

**Microscopic Characteristics:** Composed of an extensive, fine hyphal network, often branching, coiled and twisted. The hyphae in *Streptomyces* do not fragment into spores as in *Actinomyces* but form a chain-like structure of aerial hyphae called a sporophore from which cells evolve terminally. The filamentous hyphae and spores measure only 1 micron in diameter. Within each cell, no well defined nucleus is discernible. *Streptomyces* lack differentiated spore-producing bodies. Its spores are smooth or spiny.

**History, Use, and/or Medical Implications:** *Streptomyces* represents 80% of all actinomycetes which inhabit mushroom compost and is selected for its beneficial properties during Phase II. (See Chapter V).

*Streptomyces griseus* is the source of the antibiotic streptomycin, first discovered by Waksman in



**Figure 186** Drawing of spore producing cells of *Streptomyces*.

1944. The autoclavable antibiotic gentamycin is derived from a genus closely allied to *Streptomyces*, the genus *Micromonospora*.

**Comments:** *Streptomyces* resemble both bacteria and fungi and are sometimes referred to as the "higher bacteria." *Streptomyces* differ from *Actinomyces* in that their spores are produced on an aerial chain-like structure and do not simply fragment from the hyphal network. Also, the filaments of *Streptomyces* frequently branch whereas those of *Actinomyces* do not. The hyphal filaments of *Streptomyces* are one fifth to one tenth as thick as that of true fungi.

Donoghue (1962) reported that a *Streptomyces* contaminant initiated fruitbodies in spawn of *Agaricus bisporus*, a species that does not normally form mushrooms on grain. Furthermore, he observed that mycelia associated with *Streptomyces* grew faster and more luxuriantly than those not infected with it. (For more information on the influence of bacteria on mycelial growth and fruiting, turn to Appendix II.)

See also *Actinomyces*.

For more information consult: Kurylowicz, W. et al., 1971 in "Atlas of Spores of Selected Genera and Species of *Streptomycetaceae*," University Park Press, Baltimore.

## ALTERNARIA

**Class:** *Fungi Imperfecti*

**Order:** *Moniliales*

**Family:** *Dematiaceae*

**Common Name:** Black Mold; Gray Black Mold; Black Point.

**Latin Root:** From "alternus" which means alternating, in reference to the chains of alternating spores, which so characterize this genus.

**Habitat & Frequency of Occurrence:**

Very common in nature, occasionally to frequently encountered in spawn production, and present in large numbers in household dust. *Alternaria* is infrequently seen on rye grain, and according to Bitner (1972), this contaminant is more prevalent on sorghum than on other grains. *Alternaria* is one of the major fungal saprophytes on grain, seeds, straw, leaves, rotting fruits and unsalted butter. In Temperate climatic zones, it is more prevalent in the late summer and fall than at any other time.

**Medium Through Which Contamination Is Spread: Air.**

**Measures of Control:** Good hygienic habits; maintenance of a low dust level; and filtration of air through micron filters.

**Macroscopic Appearance:** A rapidly growing rich gray black to blackish mycelium. *Alternaria* first appears as scattered blackish spots in the spawn jars, soon spreading and overwhelming The mushroom mycelium. On agar, it resembles a black *Penicillium*-like mold.

**Microscopic Characteristics:** Vertically oriented lengths of cells (hyphae) emerging from a mat of mycelium that segregates into conidia, and which originated through pores at the apices of vertically oriented hyphae. Conidia (spores) are usually multicelled, sometimes Two celled and large, measuring 20-100 x 6-30 microns.

**History, Use and/or Medical Implications:** Species in This genus causing allergies and other respiratory ailments in humans, particularly hay-fever. Because of their large size, *Alternaria* spores soon settle, falling at a rate of 3 millimeters/second in still air.

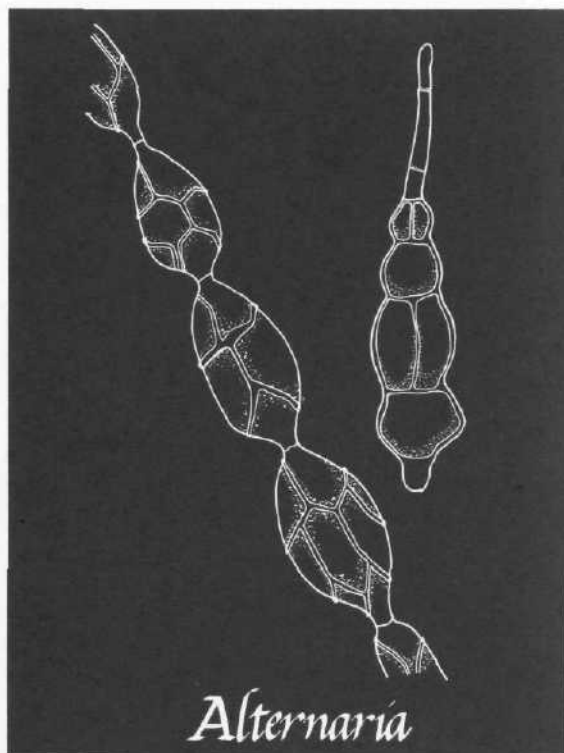

**Figure 187** Drawing of conidia typical of the genus *Alternaria*.

**Comments:** A black mold, occasional to common on enriched agar, easily separated from similarly colored molds by its unique conidia (spores). It has been claimed that *Alternaria* more frequently contaminates sorghum than rye although the authors can not corroborate this statement from their experiences.

See *Aspergillus* and *Cladosporium*.

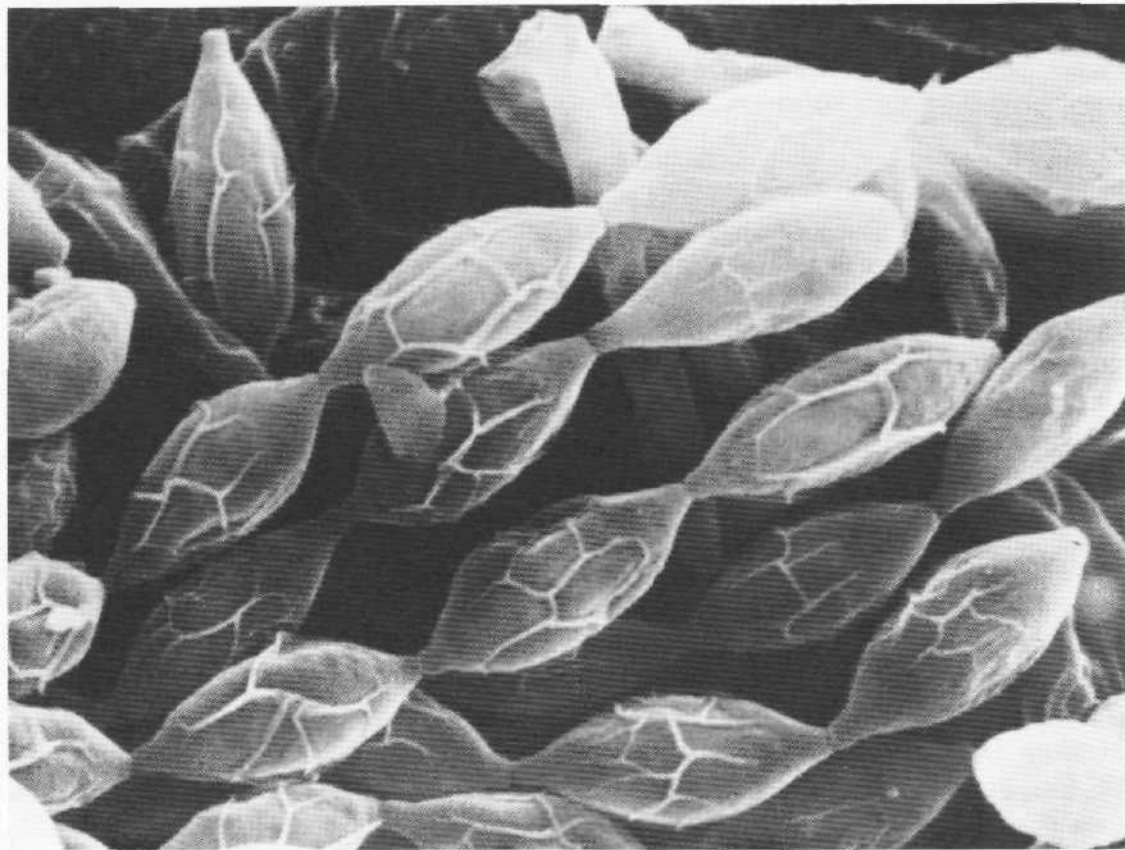

Figure 188 Scanning electron micrograph of *Alternaria* conidia.

## ASPERGILLUS

Class: *Fungi Imperfecti*

Order: *Moniliales*

Family: *Eurotiaceae*

Common Name: Green Mold; Yellow Mold; Black Mold

Latin Root: From "aspergilliformis" which means brush-shaped in reference to the shape of the conidiophore.

**Habitat & Frequency of Occurrence:**

Very common in agar and grain culture, and in compost making. Found on most any organic substrate, *Aspergillus* prefers a near neutral to slightly basic pH. Well used wooden trays and shelves for holding compost are frequent habitats for this contaminant in the growing house.

**Medium Through Which Contamination Is Spread: Air.**

**Measures of Control:** Good hygienic practices; removing supportive substrates, especially food residues and spent compost; and filtration of air through micron filters.

**Macroscopic Appearance:** Species range in color from yellow to green to black. Most frequently, *Aspergillus* species are greenish and similar to *Penicillium*. *Aspergillus niger*, as its name implies, is black; *Aspergillus flavus* is yellow; *Aspergillus clavatus* is blue-green; *Aspergillus fumigatus* is grayish green; and *Aspergillus versicolor* exhibits a variety of colors (greenish to pinkish to yellowish). These molds, like many others, change in color and appearance according to the medium on which they occur. Several species are thermophilic.

**Microscopic Characteristics:** Sporulating structure tall, unbranched, stalk-like, supporting at its apex a spherical head to which linearly arranged chains of single celled spores (conidia), measuring 3-5 microns, are attached.

**History, Use and/or Medical Implications:** Some species toxic. *Aspergillus flavus*, a yellow to yellowish green species, produces the deadly aflatoxins. *A. flavus* attacks cottonseed meals, peanuts and other seeds high in oil that have been stored in hot, damp environments. Of all the biologically

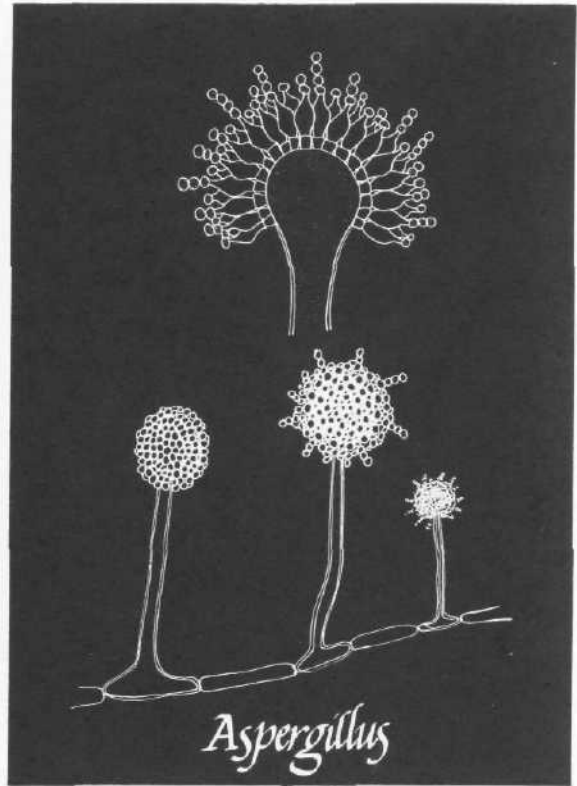

**Figure 189** Drawing of the characteristic sporulating structure of *Aspergillus*.

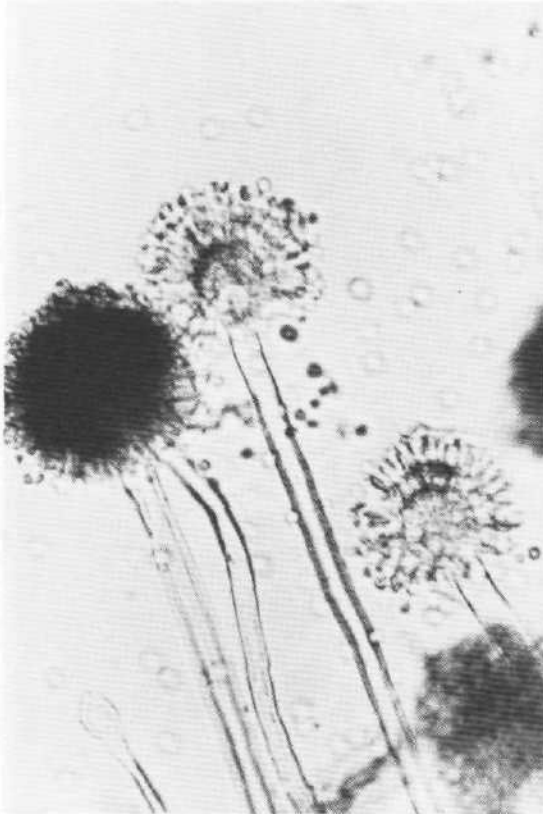

**Figure 190** *Aspergillus* species as seen through a light microscope.

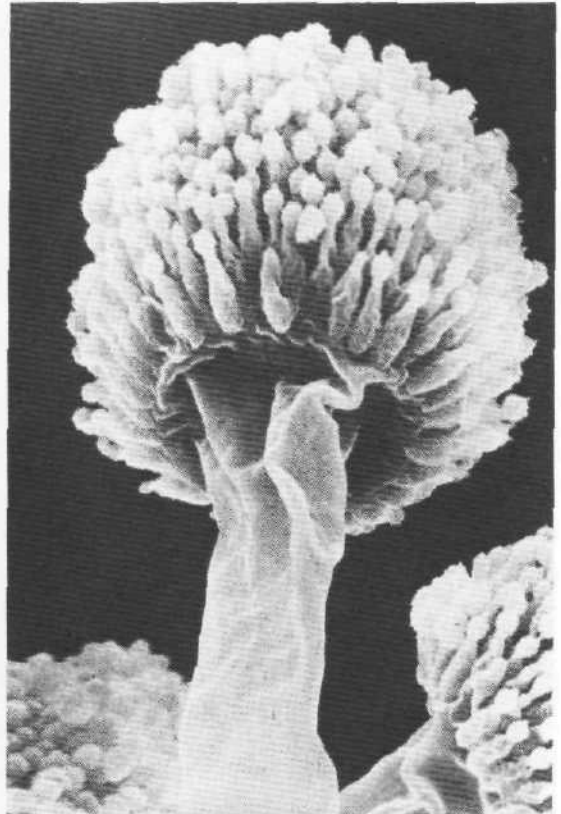

**Figure 191** Scanning electron micrograph of sporulating *Aspergillus*.

produced toxins, the aflatoxins are the most potent hepatocarcinogens yet found. The toxicity of this species was largely unknown until, in 1960, 100,000 turkeys mysteriously died from an outbreak of this disease in Great Britain.

Since *A. flavus* grows on practically all types of grain, this species is of serious concern to mushroom spawn producers. Careful handling of any molds, particularly those of the genus *Aspergillus*, should be a primary responsibility of all managers and workers in mushroom farms, Aflatoxins are not, however, taken up in the fruitbodies when contaminated spawn or cottonseed meal is used to supplement a compost.

*Aspergillus fumigatus* and *Aspergillus niger*, two thermotolerant mesophiles, are also pathogenic to humans in concentrated quantities. The affliction is called aspergilliosis or "Mushroom Worker's Lung Disease". Spent compost is the most frequent source of *Aspergillus fumigatus*.

*Aspergillus niger*, the common black mold, has been cultured commercially for its ability to



synthesize citric acid and gluconic acid from a simple sucrose enriched solution. In the past, citric acid was extracted from lemon juice; now it is made more profitably from this fungus.

**Comments:** This is a dangerous genus. Since one can encounter *Aspergillus flavus*, *A. niger*, *A. fumigatus* in the course of mushroom culture, precautionary steps should be undertaken to minimize exposure to these toxic contaminants.

*Aspergillus candidus* is a cream colored mold whose colonization of the grain results in a sharp escalation of the spawn temperature.

See also *Penicillium*. For further information consult "The **Genus Aspergillus**" by Raper and Fennel, a monograph in which 132 species were recognized. Presently, more than 200 species are known.

See Color Photograph 21.



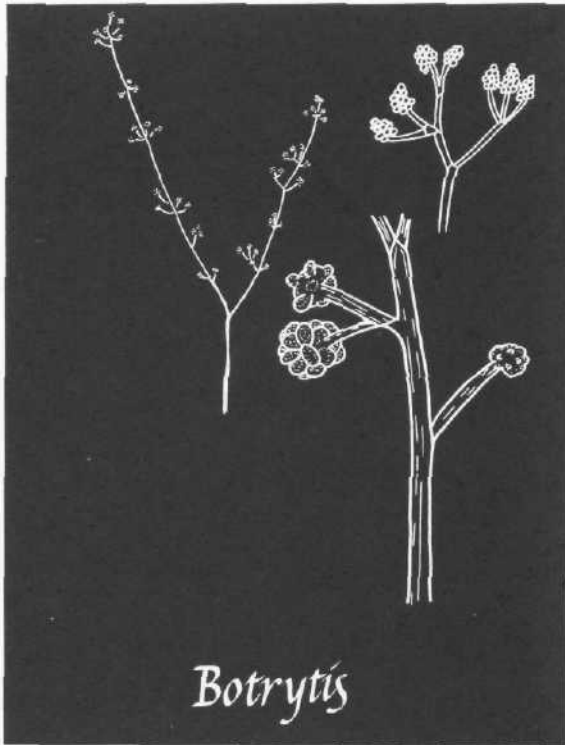

**Figure 192** Drawing of sporulating structure and spores (conidia) characteristic of *Botrytis*.

## BOTRYTIS

**Class:** *Fungi Imperfecti*

**Order:** *Moniliales*

**Family:** *Moniliaceae*

**Common Name:** Brown Mold.

**Latin Root:** From “botry” meaning bunch, as in a bunch of grapes, which the clusters of spores resemble.

**Habitat & Frequency of Occurrence:** Common, most frequently seen on the casing soil where it prefers a mixture high in woody tissue; thriving in an environment of high humidity and moderate temperature. *Botrytis* often occurs on woodwork where moisture has condensed. It is less frequently seen on compost.

**Medium Through Which Contamination Is Spread:** Air; soil; and damp wood.

**Measures of Control:** Use of clean casing soils; removal and isolation of contaminated trays which are then thoroughly steam cleaned; positive pressurization of the growing room; and adherence to a strict schedule of hygiene to prevent this mold from spreading.

**Macroscopic Appearance:** White at first, especially along the margins, soon gray, fast growing, aerial, then dull golden brown to cinnamon brown as spores mature, spreading from casing soil to woodwork and vice versa. Spores become easily airborne by the slightest drafts. Outbreaks last two weeks at most, and sometimes develop into the sexual stage indicated by the formation of cup-like fruitbodies.

**Microscopic Characteristics:** Conidiophores long, measuring 10-20 x 5-15 microns, simply but irregularly branched at the apex but not enlarged, and not *Verticillium*-like. Spores (conidia) are one celled, oval to oblong, clear to grayish, some more brightly colored.

**History, Use and/or Medical Implications:** Apparently innocuous; no toxic species known. *Botrytis cinerea* is a species highly valued for its timely attack on ripening grapes. This species

decreases the grapes' acidity while increasing their sugar content. It gives the grapes a most desirable odor and flavor, making infected crops ideal for sauterne table wines. Consequently, wine-makers have been experimenting with the deliberate inoculation of their vineyards with *B. cinerea* for more than a century.

**Comments:** If the compost overheats during spawn run or casing colonization, *Botrytis* flourishes. It is generally not considered to be a "problem" contaminant but looked upon as an "indicator" mold by mushroom growers. *Botrytis* is usually overwhelmed or contained by the mushroom mycelium, although severe outbreaks, if not checked in their growth, can be detrimental to yields. *Botrytis crystallina* or *Botrytis gemella* are probably the species most commonly encountered.

The taxonomy of the *Botrytis* species seen in mushroom culture is unresolved, and therefore placing these molds in the *Botrytis* complex avoids nomenclatural problems. *Botrytis* has a perfect stage as *Peziza ostracoderma*, one of the common cup fungi. Some authors consider the imperfect form to more properly be classified in the genus *Chromelosporium* (belonging to the species *C. fulva*). By whatever name, this frequently encountered brown mold is not regarded as a virulent competitor.

*Papulospora byssina*, the Brown Plaster Mold, is similar but can be distinguished from *Botrytis* by the powdery granules evident using a hand lens, and by the shape of the conidiophore as viewed through a microscope.

See Color Photograph 23.

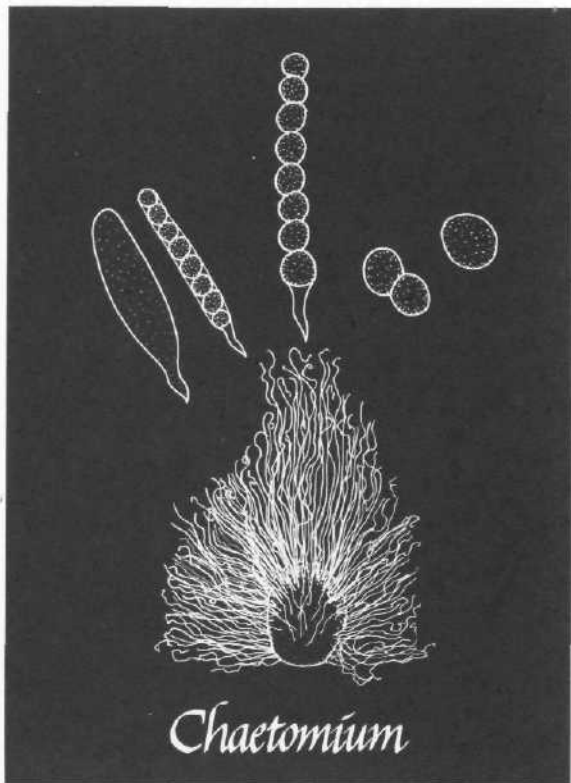

**Figure 193** Drawing of *Chaetomium* perithecium, asci and spores.

## CHAETOMIUM

**Class:** *Ascomycetes*

**Order:** *Sphaeriales*

**Family:** *Chaetomiaceae*

**Common Name:** The Olive Green Mold.

**Greek Root:** Having the same root as the suffix “-chaeta” which means long hair.

**Habitat & Frequency of Occurrence:**

Common on fresh manure; especially on compost that has been anaerobically pasteurized; refuse materials; straw; "leaf mold"; soils; plant debris; paper products; and cloth fabric. *Chaetomium* is a rare contaminant of grain and is infrequently seen in agar culture. A white species occurs on the casing layer.

**Medium Through Which Contamination Is Spread:** Air; soil; compost; and grain.

**Measures of Control:** General hygienic practices; aerobic pasteurization and Phase II. See Comments.

**Macroscopic Appearance:** Mycelia inconspicuous at first, grayish and in some species whitish, cottony, dense and aerial (as in "White Chaetomium"). Some forms become light brown, yellowish or with orangish hues when well developed. At maturity these molds can become dark green to olive green colored, and form scattered "burrs" which in fact are perithecia containing spores.

**Microscopic Characteristics:** Mycelium forming a thin walled envelope (a perithecium) from which unbranched hairs extend. A slit in the perithecium exposes sacs (asci) containing spores which are then liberated into the air. Spores are unicellular, darkly pigmented and can be ovoid, lemon-shaped or ellipsoid.

**History, Use and/or Medical Implications:** Secreting a compound called "chaetomin" that is toxic to Gram-positive bacteria and to mushrooms and other fungi.

**Comments:** *Chaetomium* inhibits mycelial growth through the toxins it produces as well as by

competing with the mushroom mycelium for base nutrients.

Several true thermophiles are present in this genus. *C. thermophile* and its many varieties thrive in temperature zones from 82-136° F. Its spores are especially heat resistant. *Chaetomium* spores are killed at 140° F. for 6-16 hours or at 130° F. for 24-48 hours, *Chaetomium olivaceum* infests compost that has been exposed to high temperature, anaerobic conditions during Phase II. Compost prepared according to the Phase II program outlined in Chapter V practically eliminates the manifestation of *Chaetomium*. *Chaetomium globosum*, the most common species in this genus, attacks straw, compost and paper products and forms small burr-like colonies. Spores of this species are less resilient than those of its thermotolerant allies.

*C. globosum* is an occasional contaminant of agar and grain culture, and like *C. olivaceum* it is common on immature composts. White *Chaetomium* grows on the casing layer as a dense whitish mold. In general, *Chaetomium* is olive green while *Penicillium* and *Trichoderma* are generally blue green or forest green in color.

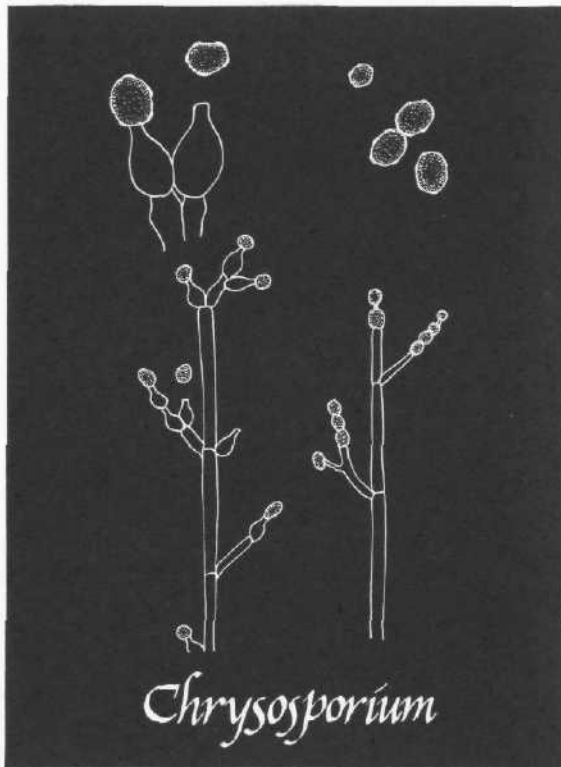

**Figure 194** Drawing of the sporulating structure typical of *Chlysosporium luteum*, the cause of Yellow Mat Disease.

## CHRYSOSPORIUM

**Class:** *Fungi Imperfecti*

**Order:** *Moniliales*

**Family:** *Aleuriosporae*

**Common Names:** The Yellow Mat Disease; Yellow Mold; Confetti Disease.

**Latin Root:** From "chryso-" meaning golden and "sporium" or spore.

**Habitat & Frequency of Occurrence:** Saprophytic, a common mold in soils, and endemic to composts prepared in direct contact with the ground. Although *Chlysosporium* species naturally inhabit the dung of most pastured animals and of chickens, today they are rarely seen in finished mushroom composts with the development of modern composting methods.

**Medium Through Which Contamination Is Spread:** Air; soil; and dung.

**Measures of Control:** Concrete surface used for composting; isolation of mushroom compost from areas where untreated soils and raw dung are being stored; and filtration of air during Phase II. If *Chlysosporium* occurs before or at the time of casing, salt or a similar alkaline buffer can be applied to limit the spread of infection.

**Macroscopic Appearance:** Whitish at first, soon yellowish towards the center and maybe yellowish overall in color, forming a "corky" layer of tissue between the infected compost and the casing soil, and inhibiting fruitbody formation.

**Microscopic Characteristics:** Conidiophores poorly developed, relatively undifferentiated, irregularly branched, vertically oriented, for the most part resembling and associated with the vegetative mycelium. Clear, unicellular and often ornamented spores (conidia) develop terminally, either in short chains or singularly, and measure 3-5 x 4-7 microns.

**History, Use and/or Medical Implications:** The genus in general does not host many pathogenic species. One species of special concern is *Chlysosporium dermatidis* and allies, a mold causing a skin disease in humans.

**Comments:** *Chrysosporium* is an indicator mold whose presence can be traced to compost prepared on soil. Yellow mat disease is caused by *Chrysosporium luteum*, a synonym of *Myceliophthalutea*. Another species, *Chrysosporium sulphureum*, is known as Confetti, and is at first whitish, then yellowish towards the center. These molds were fairly common in *Agaricus* culture previous to 1940, when composts were prepared directly on soil. With the advent of concrete composting wharfs, they have all but disappeared. According to Atkins (1974), this contaminant is more frequent in cave culture because of the use of ridge beds made directly on the floor of the cave. *Chrysosporium* is usually not detected until the first break and retards subsequent flushes. Moderate to severe outbreaks of either species can adversely affect yields.

Both raw and prepared composts can become infected with this mold. It is thought that the spores are introduced with the fresh air during the cool down period of the Phase II or from thermo-tolerant spores from within the compost itself. Species in this genus can be found on media of poor nutritional quality. They are generally not seen in spawn culture.

*Chrysosporium* can be grown for study on a hay infusion agar supplemented with sugar. Many *Chrysosporia* have sexual forms in the Gymnoascaceae, an ascomycetous family.

**For further information see:**

Carmichael, J.W., 1962 "*Chrysosporium* and some other Aleuriosporic Hyphomycetes."

van Oorshot, C.A.N., 1980 "A Revision of *Chrysosporium* and Allied Genera". Studies in Mycology No. 20. CBS Publication. Baarn, Nederland,

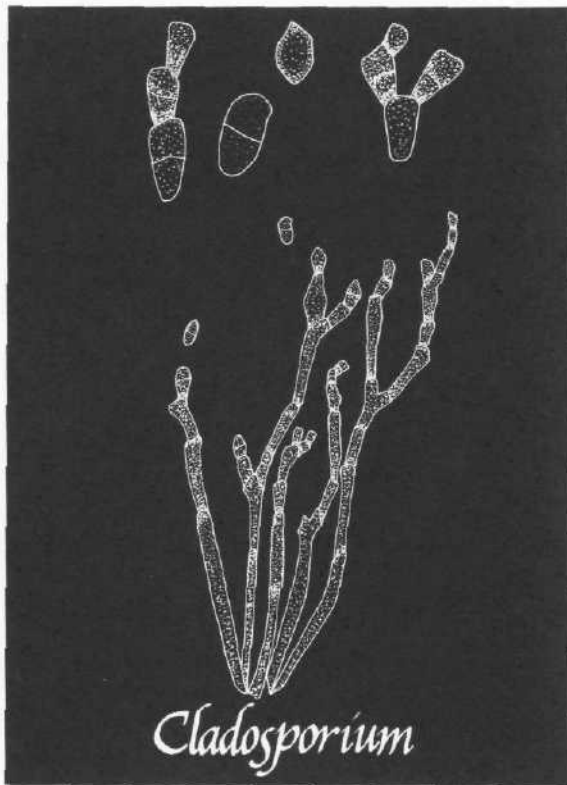

**Figure 195** Drawing of *Cladosporium*. Note the two celled conidia.

## CLADOSPORIUM

**Class:** *Fungi Imperfecti*

**Order:** *Moniliales*

**Family:** *Dematiaceae*

**Common Name:** The Dark Green Mold.

**Greek Root:** From “klados” which means branched and “sporium” or spore. The name is in reference to the two celled spores produced on branches from the main body of the *conidiophore*.

**Habitat & Frequency of Occurrence:**

*Cladosporium* is the most predominant genus of all the airborne contaminants. Its species can be both saprophytic and parasitic. At least three species infect grain spawn although they are not as common as the *Aspergilli* and *Penicillia*. Most species grow

poorly on malt agar media, Many decompose paper products (several of the black molds on old books are *Cladosporia*), plant debris, vegetables and other higher plants.

**Medium Through Which Contamination Is Spread:** Air.

**Measures of Control:** Good hygienic practices; removal of supportive substrates; and filtration of air through micron filters.

**Macroscopic Appearance:** Species of *Cladosporium* causing problems in spawn production are typically dark green in color, often becoming blackish with age, and resemble the powdery *Penicillium* type molds.

**Microscopic Characteristics:** Conidia (spores) and conidiophores distinctly septate; darkly pigmented; conidiophores vertically oriented and variously diverging; tall; forked into several terminal shoots at the apex from which the conidia arise in a chain-like fashion with the basal conidium being the oldest and the apical one being the youngest. Conidia are one or two celled, developing from the swollen ends of the conidiophores, and variously shaped (measuring from as small as 3-6 x 2-3.5 microns to as large as 15-20 x 6-8 microns). Some conidia are ovoid, lemon shaped and



cylindrical, or are simply irregular in form and have peg-like markings ("scars") where adjacent spores have been attached.

**History, Use and/or Medical Implications:** Some species toxic. *Cladosporium carrionii* causes a severe skin infection that is usually associated with workers who suffer punctures from thorns or splinters.

**Comments:** In one study (Kramer, 1959) where agar plates were exposed daily to the outside air over a period of two years, *Cladosporium* spores were found to be the most numerically common of all airborne fungi, representing 45% of the totals tallied. Of these species, *C. cladosporioides* was the most frequently encountered. In contrast, *Penidllium* is the most common fungus indoors, undoubtedly due to the food habits of humans.

The dark conidiophore and the two celled conidia (spores) are the most distinguishing features of this genus. Over 160 species have been described. The perfect stage of a variety of *C. herbarum* Link ex Fr. is *Mycosphaerella tulasnei* Janz. *C. herbarum* has been isolated from timber, logs and wood pulp. *Cladosporium resinae* lives on creosote and other petroleum products, including the petroleum jelly used to "grease" the seals of pressure cookers. *C. fulvum* Cke. attacks tomato leaves, appearing as brown to violet colonies. Other molds similar in appearance are *Penidllium* and *Aspergillus*.

For more information see "Contribution to the Knowledge of the Genus *Cladosporium* Link. ex Fr." by De Fries, 1952.

See Color Photograph 20.



**Figure 196** *Coprinus*, the Inky Cap, on horse manure.

## COPRINUS

**Class:** *Basidiomycetes*

**Order:** *Agaricales*

**Family:** *Coprinaceae*

**Common Name:** Inky Cap.

**Habitat and Frequency of Occurrence:**

Frequent to common on compost and/or decomposing straw.

**Medium Through Which Contamination Is Spread:** Primarily air; secondarily through materials used in compost preparation.

**Measures of Control:** Proper Phase I and Phase II management, especially full term pasteurization; reduction of ammonia and water in finished compost; and homogenous consistency of compost structure (avoidance of densely compacted zones).

**Macroscopic Appearance:** Appearing as a fast growing whitish mycelium, typically fine and lacking rhizomorphs, soon knotting into small ovoid primordia that quickly enlarge into a whitish mushroom with a long fragile stem and oblong cap. The cap soon disintegrates into a black inky liquid with spore maturity.

**Microscopic Characteristics:** Smooth, elliptical spores produced on club-shaped cells called basidia. Hyphae often have clamp connections joining adjacent cells.

**History, Use and/or Medical Implications:** *Coprinus* species are noted for both their edibility and toxicity. *Coprinus comatus*, the Shaggy Mane, is a popular edible and choice species that is cultivated. (See the growing parameter outline for that species). *Coprinus atrementarius* has been reported by Atkins (1973) to be a competitor to the commercial cultivation of *Agaricus*, occurring in under-composted straw/manure. This species also causes severe nausea and other unpleasant symptoms if alcohol is consumed within twenty fours of ingestion. Jonsson et al. (1979) reported marked reduction in sperm counts in rats treated with coprine, the same compound responsible for the above described symptoms.

**Comments:** *Coprinus* spores are noted for their heat resistance and often survive the composting

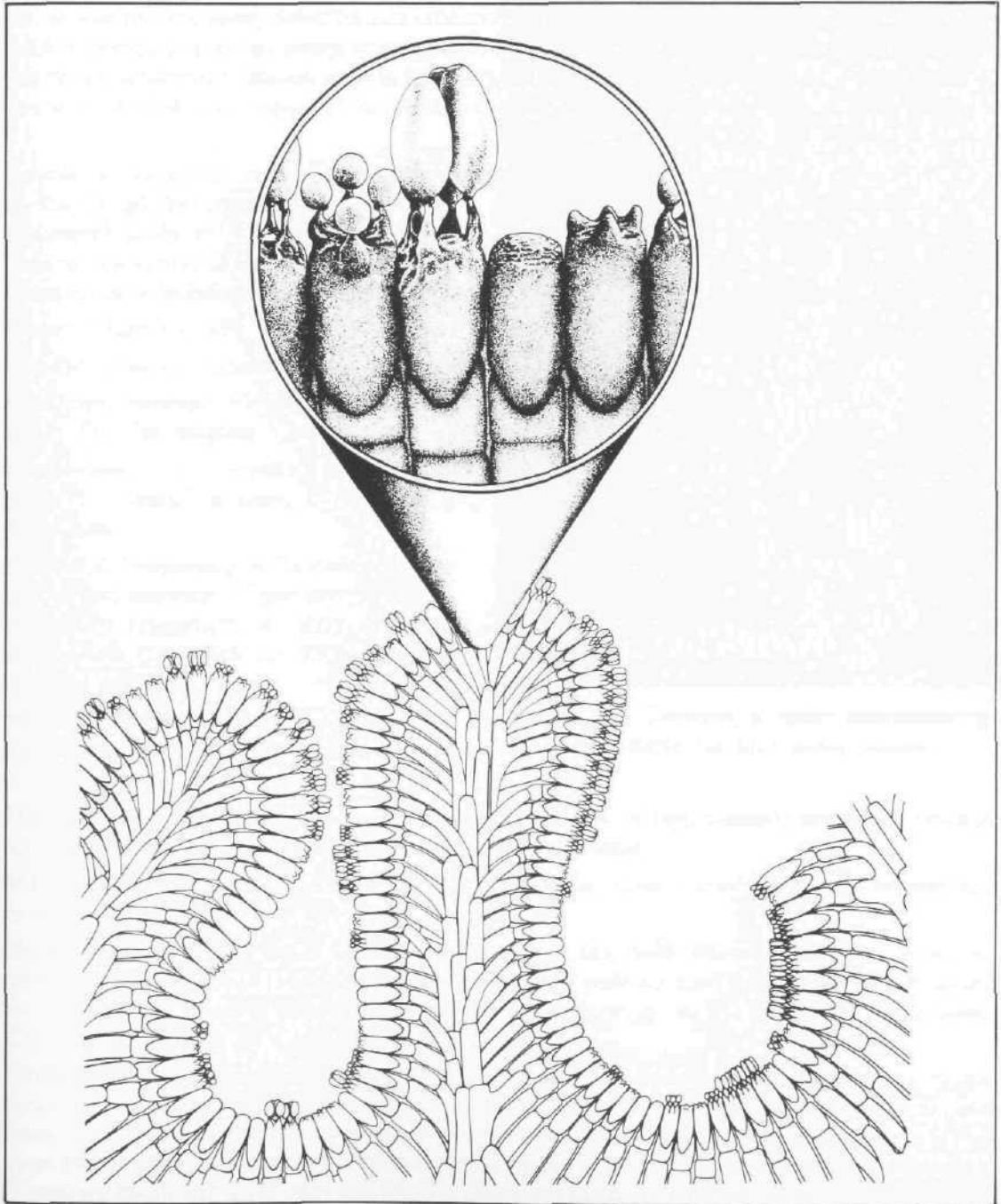

Figure 197 Drawing of gill cross section with basidia and spores of *Coprinus*.

process. Although not considered a dangerous competitor, species in this genus are common in the piles of beginning compost makers. If this species occurs during spawn run or at cropping, it is an indication of residual ammonia in the compost. Composts that have excessive ammonia concentrations, composts that have been over-watered or those that are not homogenous in their structure encourage *Coprinus* infestation.

The species known to contaminate manure/straw composts are: *Coprinus fimetarius*; *Coprinus atrementarius*; and *Coprinus niveus*. According to Kurtzman (1978), *Coprinus fimetarius* has potential value as a commercially cultivated mushroom. All the above mentioned species are ones seen in poorly prepared composts. Bitner (1972) noted that *Coprinus* is a contaminant of grain spawn, although rarely seen and present in only one of every hundred or so contaminated spawn jars.

## CRYPTOCOCCUS

**Class:** *Fungi Imperfecti*

**Order:** *Cryptococcales*

**Family:** *Cryptococcaceae*

**Common Names:** The Yellowish Brown Yeast; The Carcinogenic Yeast.

**Greek Root:** From "kryptos" meaning hidden and "kokkus" or berry, for the form of the conidia.

**Habitat & Frequency of Occurrence:** Ubiquitous and common. *Cryptococcus* species are mostly saprophytic on plant debris, in soils, cereal grains and on bird (pigeon or chicken) droppings.

**Medium Through Which Contamination Is Spread:** Air and pigeon and/or chicken wastes.

**Measures of Control:** Good hygienic practices; elimination of high humidity pockets; removal of supportive substrates; and filtration of air through micron filters.

**Macroscopic Appearance:** A spherical yeast not forming a pseudomycelium, encapsulated by a cream to brown colored mucus.

**Microscopic Characteristics:** Conidia (spores) vary in size, 4-20 microns in diameter; ovoid; reproducing through simple budding; not forming a true mycelium; and lacking a specialized spore-forming structure. In some species there can be a simple ascus (a "sack") enclosing a single spore. *Cryptococcus* species are Gram-positive.

**History, Use and/or Medical Implications:** A non-fermenting yeast with alliances to the *Ascomycetes*, *Cryptococcus neoformans* (Sanf.) Vuill. causes a deadly disease in animals and humans called *cryptococcosis*, otherwise known as "Torula meningitis" or "yeast meningitis". This yeast attacks and reproduces in the central nervous system, particularly in the brain and spinal fluid. Symptoms begin with a stiff neck and headache and end in total or partial blindness, paralysis, coma and respiratory failure. Less severe symptoms occur in other parts of the body, for which there is a

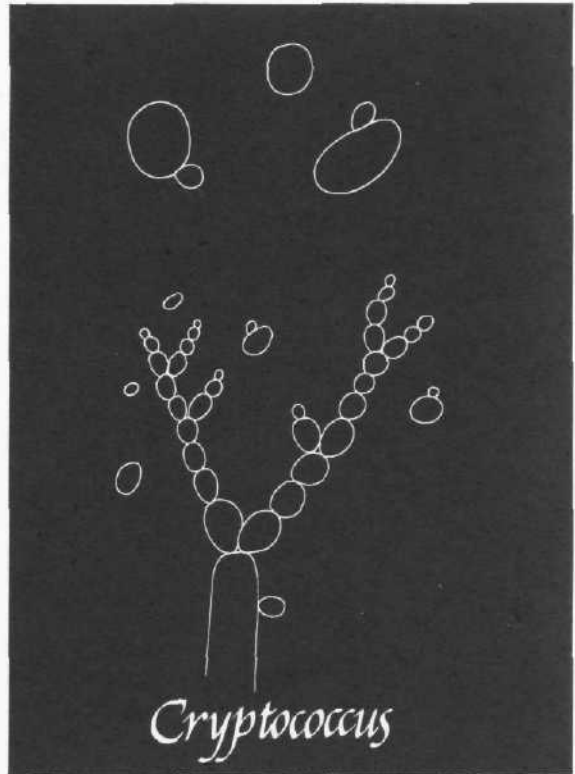

**Figure 198** Drawing of spore formation typical of *Cryptococcus* and many yeasts.

better chance of recovery. It is believed that airborne spores are inhaled, entering the body via the lungs. This yeast thrives in droppings of pigeons and chickens.

**Comments:** *Cryptococcus* is a non-fermenting yeast with alliances to some Ascomycetes: *Torula* (Black Yeast), *Rhodotorula* (Red Yeast) and *Candida*.

In 1979 one of the containment buildings at the Tennessee Clinch River Breeder Reactor project had to be quarantined because of a massive outbreak of *Cryptococcus neoformans*.

## DACTYLIUM

**Class:** *Fungi Imperfecti*

**Order:** *Moniliales*

**Family:** *Moniliaceae*

**Common Name:** Cobweb Mold; Downy Mildew; Soft Mildew.

**Greek Root:** From “daktylos” meaning finger, in reference to the forking of the conidiophore.

**Habitat & Frequency of Occurrence:** Commonly seen on the casing soil or parasitizing the mushroom fruitbody.

**Medium Through Which Contamination Is Spread:** Air; casing soil; water and insects.

**Measures of Control:** Immediate isolation of parasitized fruitbodies from the growing environment; lowering of the relative humidity; and/or increasing air circulation. Carefully examine casing soil components for hygienic quality. Pasteurization of casing soil generally prevents its occurrence. Growth can be stopped by covering the cobweb mold with salt, baking soda or any highly alkaline compound.

**Macroscopic Appearance:** *Dactylium dendroides* Fr. is cobweb-like in appearance, first appearing as small scattered patches rapidly running over the surface of the casing soil, then overwhelming any and all mushrooms in its path. Afflicted mushrooms are covered with a fluffy down of delicate mycelium. This mold is initially grayish, sometimes whitish and can become pinkish tinged with age. When cut open, infected mushrooms are composed of rotting flesh and young buttons are reduced to formless masses of soft tissue.

**Microscopic Characteristics:** Conidia multicelled, usually composed of three or more connected cells. Conidia can occur singly or clustered, terminally positioned on the ends of branches which often fork in a *Verticillium*-like fashion and which originate from a major vertical shoot. Conidia are

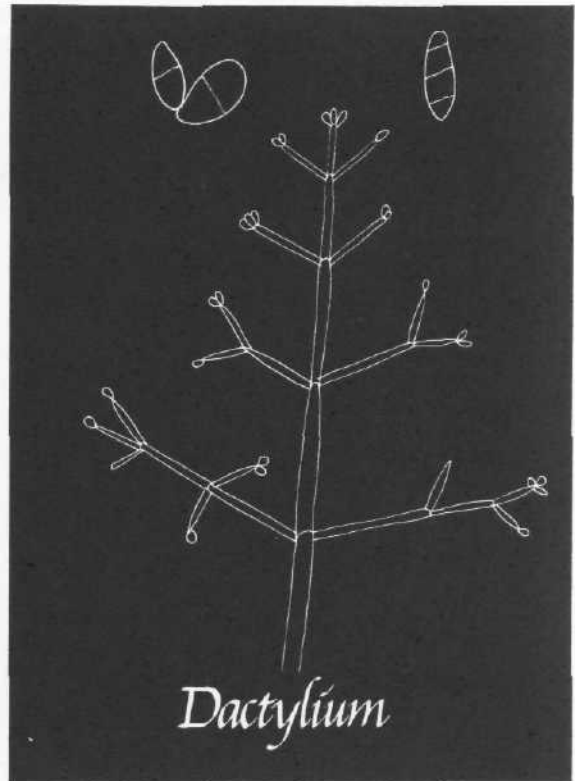

**Figure 199** Drawing of sporulating structure of *Dactylium*. Note multicelled conidia.



**Figure 200** Photograph of *Dactylium* running through casing layer.

clear or slightly yellowish in color and measure 20 x 5 microns.

**History, Use and/or Medical Implications:** None noted.

**Comments:** The Cobweb Mold is a fast growing, tenacious casing layer contaminant. Spores germinate upon contact with a mushroom, and soon envelope it with a soft mildewy mycelium.

Spores of *Dactylium dendroides* are killed when exposed to 115-122°F. for only ½ hour. (See Anderson, 1956). The genus *Dactylaria* is synonymous with *Dactylium*. Several species are known for their specialization in trapping nematodes by arranging their hyphae into loose coils. When one enters a loop, the hypha contract and traps the nematode.

*Dactylium* is the conidial form of *Hypomyces*, some species of which attack wild mushrooms, particularly *Lactarius*, *Russula*, *Agaricus*, *Amanita* and others. *Dactylium dendroides* is the asexual form of *Hypomyces rosellus*.

**For more information consult:**

Lentz, P.L. 1966 "*Dactylaria in Relation to the Conservation of Dactylium.*" Mycologia 58: 965-966.



## DORATOMYCES (STYSANUS)

**Class:** *Fungi Imperfecti*

**Order:** *Moniliales*

**Family:** *Stilbellaceae*

**Common Names:** The Black Whisker Mold; The Smoky Grey Mold.

**Habitat and Frequency of Occurrence:** A saprophyte, occasionally to frequently seen on the straws of an inadequately pasteurized compost; on wooden trays; rarely spreading to the casing soil; sometimes contaminating grain cultures; and seldom seen on agar. In nature *Doratomyces* is a major constituent of a soil's microflora.

**Medium Through Which Contamination Is Spread:** Primarily an airborne contaminant; secondarily transmitted through spent compost and left over debris.

**Methods of Control:** Air filtration; correct preparation and pasteurization of compost; and adherence to a strict schedule of hygiene in the laboratory and growing room. Whenever a room becomes contaminated with this fungus, a thorough cleaning is in order, particularly any trays that harbored this rapidly growing contaminant. The most common source of this fungus is spent compost or newly Turned soils.

**Macroscopic Appearance:** A heavily sporulating grayish to blackish mold, permeating throughout the compost and when disrupted, emitting clouds of grayish spores. Contaminated regions of compost are more darkly colored and seem damper than uncontaminated regions. Its common name, the Black Whisker Mold, well describes the macroscopic appearance.

**Microscopic Characteristics:** Hyphae, conidiophores and conidia darkly pigmented. Conidiophores are single or aligned as compacted vertical assemblages of hyphae that variously diverge near the apex into short chains of dry, ovoid, unicellular spores in a *Penicillium*-like fashion.

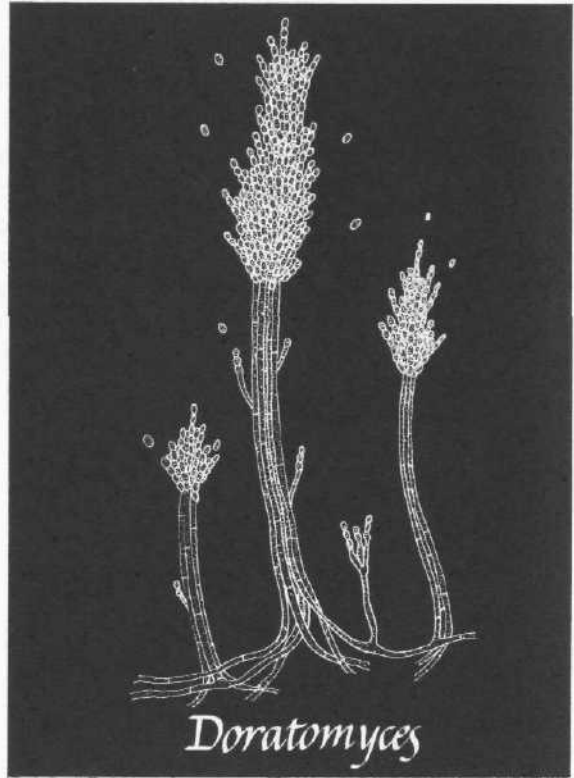

**Figure 201** Drawing of the sporulating structure of *Doratomyces (Stysanus)*, the Black Whisker Mold.

**History, Use and/or Medical Implications:** Some species toxic. *Doratomyces* causes an asthma-like respiratory response (coughing, soreness of throat, nose bleeds) in those who are exposed to concentrations of its spores. Workers emptying spent compost from growing houses are the most likely To be inflicted with this illness.

**Comments:** *Doratomyces* is synonymous with *Stysanus*. *Doratomyces microsporus* (= *Stysanus microsporus*), the Smoky Grey Mold and *Doratomyces stemonitis* (= *Stysanus stemonitis*), the Black Whisker Mold, both contaminate the compost and emit huge quantities of spores when disturbed. A moderately strong competitor of mushroom mycelium, this mold grows well in under-composted, poorly pasteurized and/or wet composts—composts poorly suited for good mushroom crops. If the compost bed heats up during spawn running and kills the grain inoculum, the grain kernels are soon attacked by this fungus which then resporulates and infects the compost. *Doratomyces* is an indicator mold, whose presence suggests poor composting, pasteurization or spawn running practices.

## EPICOCCUM

**Class:** *Fungi Imperfecti*

**Order:** *Moniliales*

**Family:** *Tuberculariaceae*

**Common Name:** Yellow Mold.

**Habitat and Frequency of Occurrence:**

An occasional contaminant of grain culture. Species in this genus are decomposers of wood, leaves and stems of plants, playing an important role in the soil community.

**Medium Through Which Contamination Is Spread:** Air; soil; and grain.

**Methods of Control:** Isolation of contaminated cultures; careful screening of grain used for inoculum; and sufficient steam permeation of grain during sterilization.

**Macroscopic Appearance:** Species in this genus are variously pigmented. In grain culture, *Epicoccum* is distinguished by its bright yellowish orange to pinkish orange color and is often associated with a yellowish fluid which it apparently exudes. Its mycelium appears as dense zones within which blackish spores are formed. On most agar media, *Epicoccum* is slow growing and whitish. Outside the laboratory, *Epicoccum* can be found on leaves and twigs, forming small black dot colonies.

**Microscopic Characteristics:** Conidiophores compact, short and radiating from cushion shaped cells called "sporodochia" and from which dark, one celled, round spores (conidia) arise or with which they are associated. The conidia are typically reticulated or ornamented with small spine-like projections, measuring (5) 1.5-25 (50) microns. These reticulated conidia appear to be composed of several tightly interconnected cells.

**History, Use and/or Medical Implications:** None noted.

**Comments:** Not strongly inhibitory to mushroom mycelium. This mold can, however, spoil

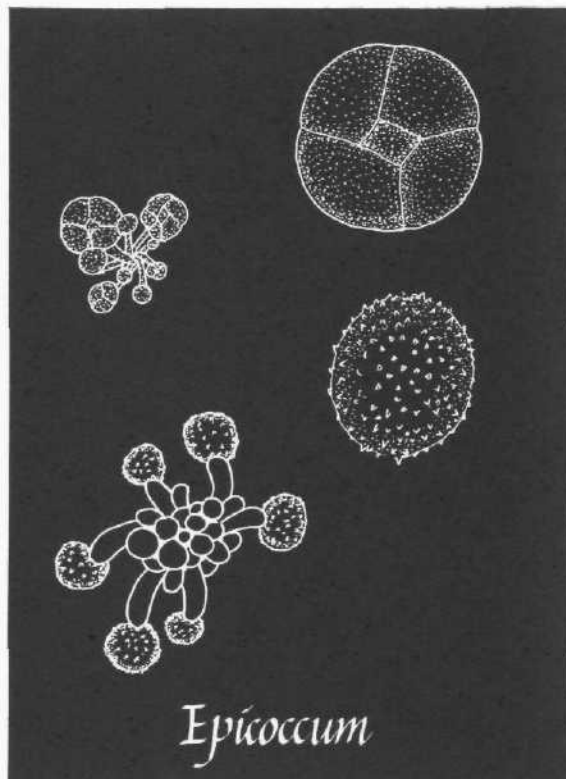

**Figure 202** Drawing of cushion shaped sporulating structure typical of *Epicoccum*, a yellow mold.

spawn. In grain culture, fruitings still develop in containers that are partially contaminated with this mold.

*Epicoccum oryzae* attacks rice, causing lesions that are pinkish to reddish in coloration. Another *Epicoccum* species was reported by Bitner (1972) To be the most common mold attacking sorghum spawn, comprising nearly 30% of all contaminated cultures. On The other hand, it represented only 5% of the contaminants on rye. The frequency with which this contaminant occurs varies substantially.

**For more information:**

M.B. Schol-Schwartz (1957), "*The Genus Epicoccum (Link.)*."

## FUSARIUM

**Class:** *Fungi Imperfecti*

**Order:** *Moniliales*

**Family:** *Tuberulariaceae*

**Common Names:** The Brightly Colored Contaminant; Damping Off Disease; or Yellow Rain Mold.

**Greek Root:** Having the same root as "fusi-form", meaning to be swollen in the center and narrowing towards the ends, in reference to the distinctive shape of the conidia.

**Habitat & Frequency of Occurrence:** Commonly encountered in spawn production and in agar culture. A natural inhabitant of grains (rye, wheat, barley, rice), *Fusaria* also are found in soils, on living and decaying plants and on decomposing textiles and paper.

**Medium Through Which Contamination Is Spread:** Air; grain; and casing soil.

**Measures of Control:** Sufficient sterilization of grain; isolation and proper disposal of contaminated cultures. General hygienic practices and air filtration prevent this contaminant. Increasing ventilation while simultaneously decreasing humidity hinders the proliferation of this potentially dangerous contaminant.

**Macroscopic Appearance:** Appearing as an extensive, fast growing, and whitish cottony mycelium which can remain whitish or, as in most cases, becomes brightly pigmented. *Fusarium* species most frequently seen on grain are shades of pink, purple or yellow.

**Microscopic Characteristics:** Conidia generally sickle shaped; multicelled; septate (segmented); and developing from short, simple and irregularly branched conidiophores that arise from a cottony mycelial mat. Conidia are canoe, crescent or sickle shaped, with the basal end notched or niched. Some pear shaped, single celled microconidia are also produced.

**History, Use and/or Medical Implications:** Some *Fusarium* species highly toxic. Throughout

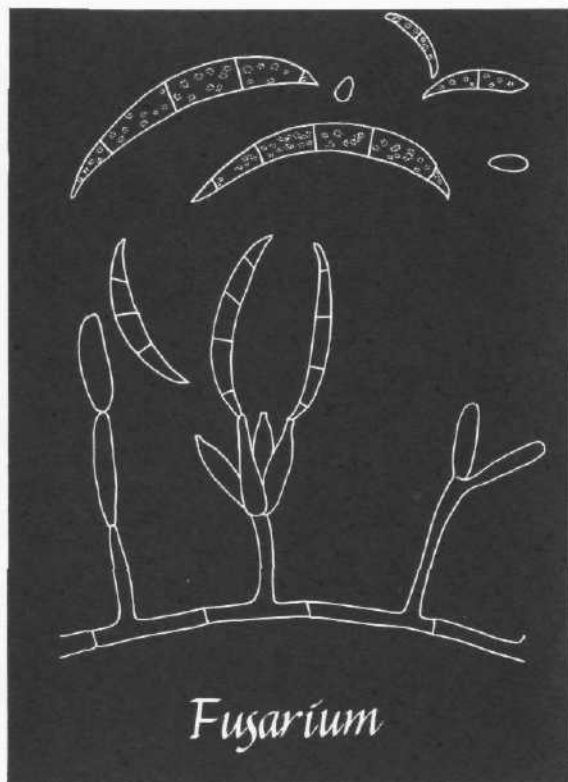

**Figure 203** Drawing of simple sporulating structure typical of the genus *Fusarium*.

correlated high levels of *Fusarium* to this phenomenon. Even a moderate infestation by this contaminant inhibits mushroom growth. Mushrooms afflicted with this disease remain small and often have disproportionately small caps and stems whose interiors are brownish. Wolfe (1937) was able to induce Damping Off Disease by first isolating *Fusaria* and then physically introducing it into The casing layer of a healthy bed.

Although not as commonly encountered as *Penicillium* or *Trichoderma*, *Fusarium* can wreak havoc in a sterile lab if not soon contained. Grain is the main source of *Fusarium* contamination in mushroom culture. Twenty-eight *Fusaria* have been identified from cereal grains, five of which have been isolated from contaminated mushroom spawn jars (see Pepper & Keisling, 1963). These are:

- F. lateritium*, a pinkish species.
- F. avenaceum*, a reddish species.
- F. culmorum*, a vivid yellowish red species.
- F. poae*, a violet colored species.
- F. oxysporum*, a red violet species.
- F. sp.*, a fast growing whitish species.

*Fusaria* can cause severe mycosis and these molds must be treated with extreme caution. Grain contaminated with *Fusarium* should be sterilized before handling.

There are, undoubtedly, more toxic species than the literature presently indicates.

One of the first patents ever to be awarded to a living organism was given for *F. gramineraum*.

**For more information see:**

Wood, F.C., 1937 "*Studies of Vamping Off of Cultivated Mushrooms and Its Association with Fusarium Species.*" *Phytopath.* 27: 85-94.

Toussoun, T.A. and P.E. Nelson, 1968 "*A Pictorial Guide to the Identification of Fusarium Species*" Pennsylvania State University Press.

Seagrave, S., 1981 "*Yellow Rain: A Test of Terror*" *Seattle Post Intelligencer*, September 27, B2.

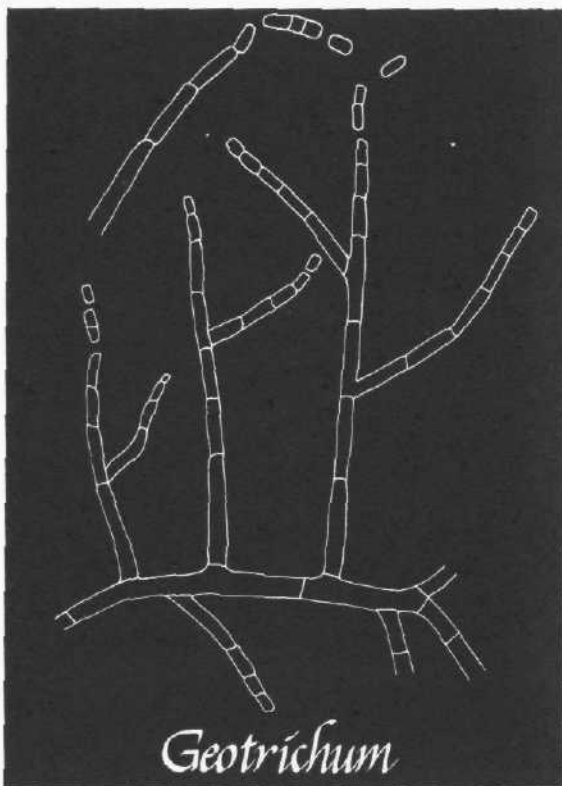

**Figure 205** Drawing of sporulating structure of *Geotrichum*, the Lipstick Mold, and its characteristically shaped conidia.

## GEOTRICHUM

**Class:** *Fungi Imperfecti*

**Order:** *Moniliales*

**Family:** *Moniliaceae*

**Common Name:** Lipstick Mold.

**Latin Root:** From "geo" meaning earth, and "trichum" meaning hairy, in reference to the character of the mycelial mat.

**Habitat & Frequency of Occurrence:** Generally a saprophyte although some forms act as parasites. *Geotrichum* species are extremely common in nature but infrequently encountered in mushroom compost—unless it has been prepared directly on soil. *Geotrichum* dwells in soils, cow dung, old straw, compost piles and rots some fruits and vegetables. In general, species of this genus are mesophilic thermophiles and are therefore sensitive to pasteurization temperatures.

**Medium Through Which Contamination Is Spread:** Air; soil; and from old straw and spent composts.

**Measures of Control:** Composting on a concrete surface; thorough pasteurization of compost and straw; and use of clean casing materials.

**Macroscopic Appearance:** Mycelium whitish at first, often taking on a "frosty" appearance and then forming whitish balls of mycelium. With age, the mycelium becomes pinkish and then reddish due to the maturation of spores. Older colonies of this fungus fade to a dull orange.

**Microscopic Characteristics:** Hyphae septate, in the form of extensive but random chains of cells, from which cylindrical conidial spores segment, measuring 5-10 x 3-6 microns. Conidiophores are simple and often indistinguishable from the mycelial network.

**History, Use and/or Medical Implications:** Few species toxic. *Geotrichum candidum* causes an oral, bronchial, pulmonary and/or intestinal disease known as geotrichosis that infects humans and other mammals.

**Comments:** Commonly encountered in agar plates made from a soil infusion; otherwise rarely encountered in sterile culture. An occasional contaminant of mushroom beds (compost), Lipstick Mold inhibits primordia formation and development. With the advent of concrete composting surfaces and peat based casings, this contaminant has been virtually eliminated from modern mushroom farms.

This fungus is closely allied to, if not synonymous with *Sporendonema purpurescens*. For more information see:

Sinden, J.W., 1971 "Ecological Control of Pathogens and Weed Molds in Mushroom Culture" Annual Review of Phytopathology 9.

Carmichael, J.W., 1957 "*Geotrichum candidum*" Mycologia 49. pp. 820-830.



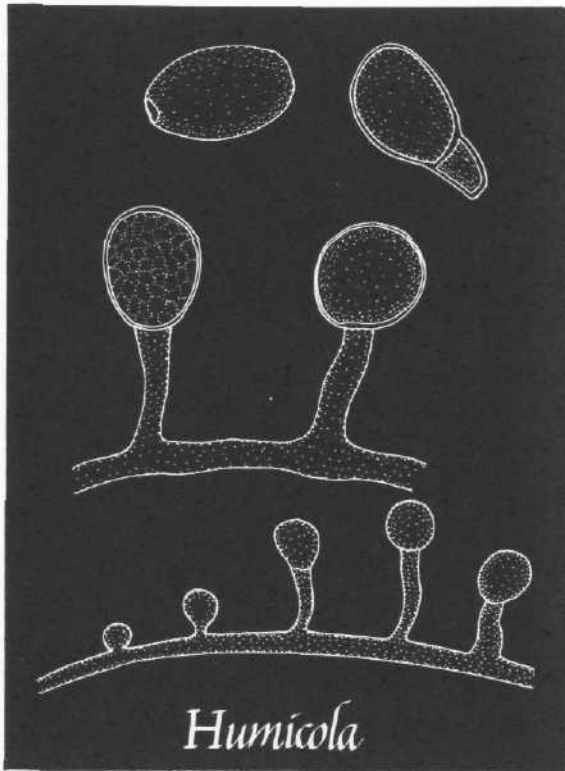

Figure 206 Drawing of sporulating structure and spores (conidia) of *Humicola*.

## HUMICOLA

Class: *Fungi Imperfecti*

Order: *Moniliales*

Series: *Aleuriosporae*

Common Name: Gray Mold.

Latin Root: From "humus" meaning soil and the suffix "cola" meaning dweller, inhabitant.

**Habitat & Frequency of Occurrence:** A rare contaminant of sterile culture. Thermophilic species are frequently seen in the second phase of composting, thriving in the 115-125 degree F. range. Naturally occurring on grains, straw, wood, soils and other organic matter high in cellulose.

**Medium Through Which Contamination Is Spread:** Air; soil; and grain.

**Measures of Control:** Thorough sterilization of grain and incubation of spawn at moderate temperatures. *Humicola* is a thermophile and thrives in elevated temperature zones. Since the presence of *Humicola* is considered beneficial to compost, no countermeasures are necessary if it occurs in that substrate.

**Macroscopic Appearance:** Mycelium on agar a fine to thick grayish to colorless mat, varying according to the media employed. On grain its mycelium is typically thick, colorless at first, soon gray and eventually dark gray with spore production. On compost, *Humicola* is an aerial, fluffy, whitish mycelium that is soon grayish with spore maturity. It is frequently seen at or near the surface where temperatures are 115-125 °F.

**Microscopic Characteristics:** Conidia one celled, typically globose, brownish colored and often sculptured. Conidiophores are also darkly pigmented, simple, undeveloped and similar to the mycelium or at times having short lateral branches at whose swollen apices a single conidium is borne. Alternately, short chains of microconidia formed by flask shaped cells (phialides) can occur.

**History, Use and/or Medical Implications:** Selected for use in compost nutrient conversion during Phase II of composting.

**Comments:** *Humicola* plays an important role in the conversion of the nitrogen in ammonia into protein rich compounds that the mushroom mycelia can digest. In this regard *Humicola* is an ally to the compost preparation process. Compost makers have long believed that *Humicola nigrescens* should be encouraged to grow during Phase II because a compost colonized with it resulted in higher yields. *Humicola* prospers in the 115-125 (130)°F. range. When the finished compost has been brought down to spawning temperature, these fungi are rendered inactive, and are then consumed by the mushroom mycelium.

On grain *Humicola grisea* is most frequently seen; on horse manure/straw composts *Humicola nigrescens* is most commonly encountered. *Humicola* that occurs during cropping does not seem to pose a serious threat to the overall crop.

Most species are mesophilic; some are thermophilic; and all are saprophytic. *Humicola* is not a problem contaminant.

See *Torula*, another thermophilic fungus beneficial to composting.

**For more information** consult:

Bels-Koning, H.C., Cerrits, J.P.G., and Vaandrager, M.H. 1962. "Some Fungi Appearing Towards the End of Composting," Mushroom Science V.

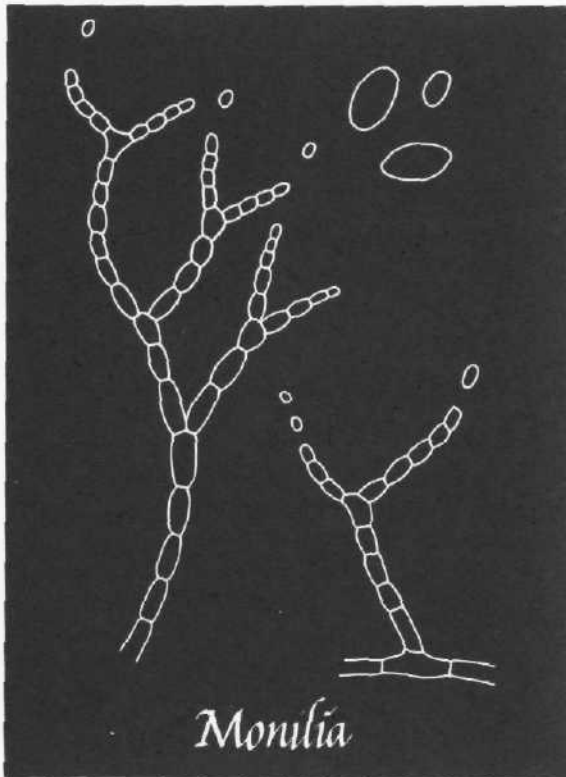

Figure 207 Drawing of chain-like structure by which *Monilia* produces conidia (spores).

## MONILIA

**Class:** *Fungi Imperfecti*

**Order:** *Moniliales*

**Family:** *Moniliaceae*

**Common Names:** White Mold; White Flour Mold; or Pink Mold

**Latin Root:** From "monile" or necklace for the chain-like arrangement of the mycelium and spore producing cells.

**Habitat & Frequency of Occurrence:** Relatively common on agar; grain; compost and casing soil.

**Medium Through Which Contamination Is Spread:** Primarily air; soil; and grain,

**Measures of Control:** Air filtration; maintenance of good hygiene in laboratory and growing room, especially in the isolation and removal of contaminated cultures and debris from previous croppings. Thorough sterilization of grain and pasteurization of casing reduces the possibility of contamination arising from within. This contaminant is believed to be externally introduced through airborne spores. High efficiency filters prevent *Monilia* spores from contaminating spawn and lessen the risk of contamination in the growing room.

**Macroscopic Appearance:** Represented by two mutable forms: the imperfect form *Monilia* is generally a fine powdery whitish mold; and the perfect form *Neurospora* is a rapid growing tenacious aerial mold that is pinkish with spore maturity. In grain both the whitish and the pinkish *Neurospora* are encountered. White *Monilia* has a remarkable resemblance to finely ground perlite and can easily be mistaken for it. On casing soil, the pink form is more common. Both are very rapid growing.

**Microscopic Characteristics:** Conidia unicellular; oval to lemon shaped; produced in large quantities on yeast-like chains with the terminal cells being the youngest and originating from a simple, septate mycelial network. Less frequently, conidial spores are produced singly. Conidiophores are

extremely simple and similar to mycelium or absent altogether. Its mycelium is hyaline, white or gray colored while the conidia are tan, gray or most commonly pink in color.

**History, Use and/or Medical Implications:** Not known to be pathogenic. A disease known as moniliasis in medicine is actually caused by a related yeast-like fungus, *Candida*, and is more correctly termed candidiasis. *Candida* has been incorrectly called *Monilia* in medical mycology texts. Several genera share the same overall microscopic features and can be easily confused with *Monilia*. Indeed, *Monilia* is a pivotal genus amongst a constellation of genera. For the purposes of the home cultivator, all these forms might be more usefully called a "complex of genera".

**Comments:** *Monilia's* perfect form is represented by *Neurospora* (see that genus) and either phenotype is largely determined by nutritional factors, particularly pH. *Monilia* can vary substantially in color on grain spawn: from a thick whitish mycelial mat to a powdery white, gray or pink colored mycelium. Perhaps the most devastating form is the whitish one for its resemblance to mushroom mycelium. Also seen in agar culture, the pink form is noted for its high aerial mycelium. It climbs the sides of petri dishes. If not treated, this contaminant can be very difficult to eradicate. Complete cleaning of the laboratory is the only recourse. After a *Monilia* outbreak careful attention must be directed at reestablishing spawn integrity.

*Monilia* and *Neurospora* attack the mushroom beds and casing layers with rapid growing grayish mycelia that soon develop pinkish tones with spore maturity. Contamination by this fungus is usually traced to unclean casing or infected spawn.

Consult the genus *Neurospora*.

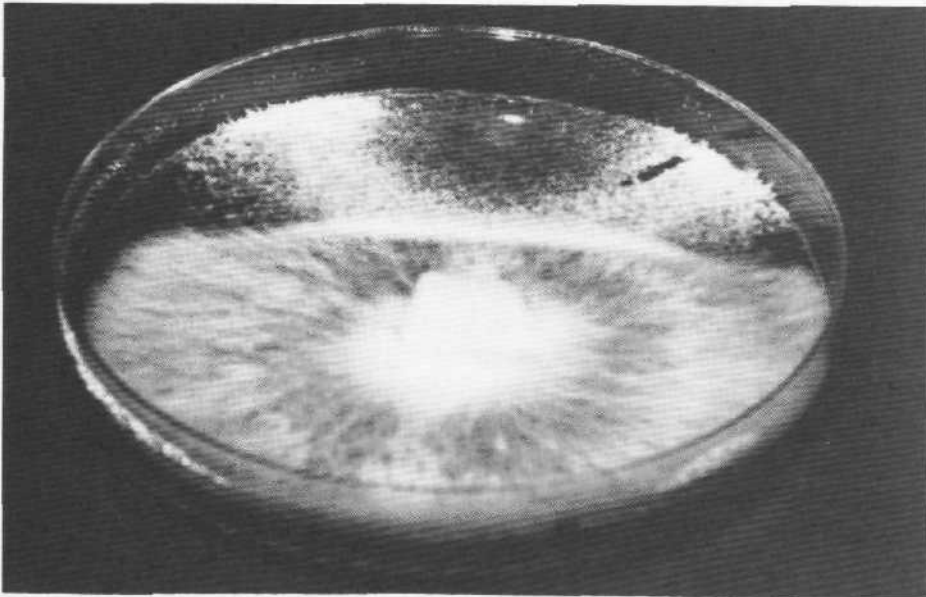
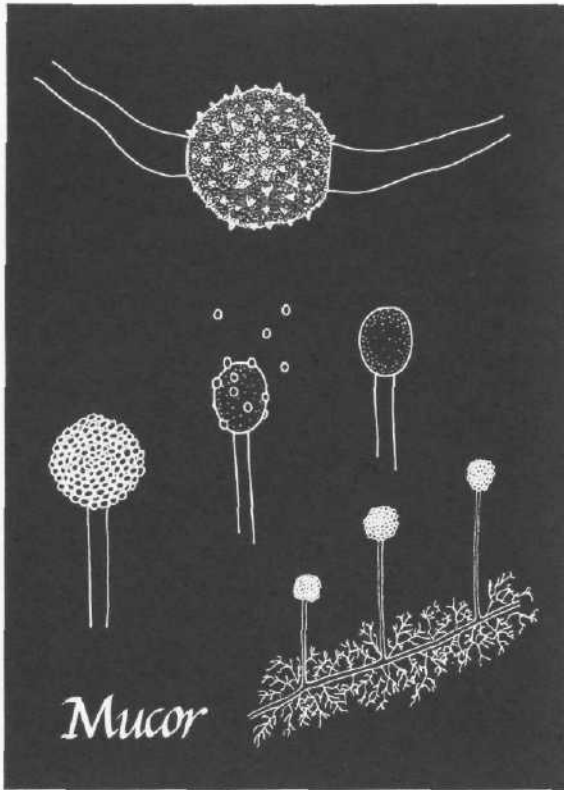

Figure 208 *Monilia-like* mold on agar media with mushroom mycelium.



**Figure 209** Drawing of sporulating structure (sporangiophore) of *Mucor*.

'spent' compost, aged mushrooms or cropping debris. Exercizing general hygienic practices usualy prevents this contaminant from becoming a problem.

**Macroscopic Appearance:** A fast growing fungus forming an interwoven dense mycelial mat, whitish at first, producing a stalk-like sporangiophore which is not swollen at the apex but is enveloped by spherical spore producing body. Soon becoming grayish and then blackish overall with spore production. When *Mucor* sporulates, it appears like a "forest of black headed pins". On malt agar, sporangiophores often do not form, making identification difficult.

**Microscopic Characteristics:** Tall sporangiophores arising singly from the mycelial mat, adorned with a spherical sporangium composed of many spores. Hyphae are non-septate (lacking distinct cell walls).

**History, Use and/or Medical Implications:** Some species toxic. *Mucor pusillus* and other mucoraceous fungi are the cause of a rare but deadly disease known as mucormycosis or phycomycosis. Although *Mucor* attacks open wounds, the outer ear and the lungs, it is not a primary parasite but one that takes advantage of poor health caused from other diseases. This disease and ones related to it are more prevalent in tropical and semitropical zones than in temperate regions. For

## MUCOR

Class: *Zygomycetes*

Order: *Mucorales*

Family: *Mucoraceae*

**Common Names:** the Black Pin Mold; the Black Bread Mold

**Habitat & Frequency of Occurrence:** A common saprophyte of stored grains; horse dung; old straw; mushroom composts; peat; soil; and plant debris. *Mucor* also rots textiles.

**Medium Through Which Contamination Is Spread:** Primarily air; secondarily grain and contaminated compost.

**Measures of Control:** Air filtration; sufficient sterilization of grain; and immediate removal and isolation of contaminated regions,

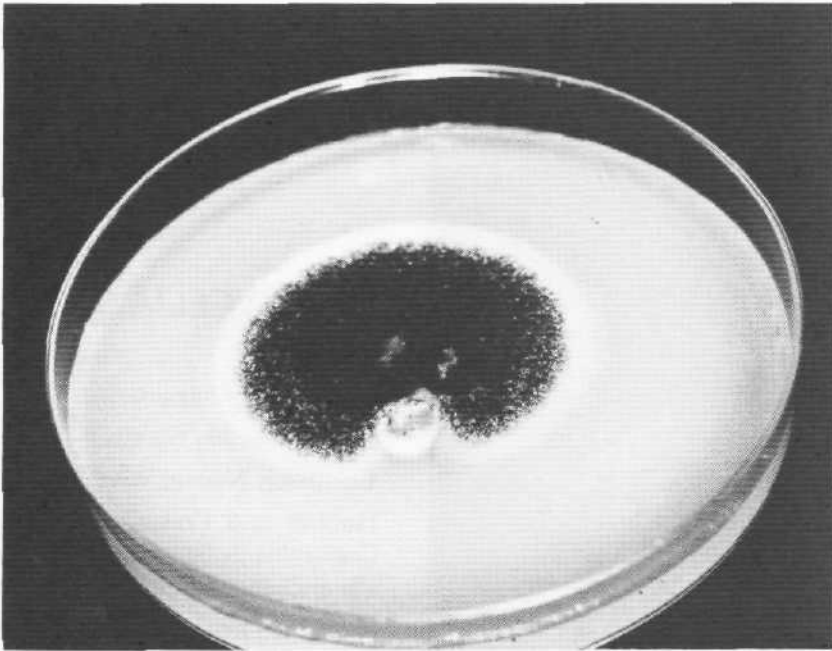

**Figure 210** *Mucor*, the Black Pin Mold, on malt agar.

more information on the pathogenic aspects of fungi in This group refer to the reference **below**.

**Comments:** A vigorous contaminant and seen at various times in spawn production, inhibiting and overwhelming the mushroom mycelium. On malt agar media *Mucor* is a fast growing, non-sporulating, cottony and whitish mycelial network competing with or overwhelming mushroom mycelium. *Mucor* mycelium is non-rhizomorphic and lacks the clamp connections that is characteristic of many mushroom mycelia.

If in doubt whether a whitish mycelium is *Mucor* or not, inoculate some bread with some mycelium covered kernels and incubate at a warm temperature. If the mold is *Mucor*, it will sporulate in a few days and be easy to identify.

The most frequently seen species of this genus are *Mucor racemosus* and *Mucor plumbeus*. *Mucor pusillus*, a true thermophile, thrives in the 68-131 ° F. (20-55 ° C.) range and is a major constituent in the microflora of compost piles. *Mucor* infected spawn, when inadvertently inoculated onto the mushroom compost, can result in the total contamination of the bed within a few days. Consult *Sepedonium*, a contaminant whose vegetative mycelia resembles the non-sporulating mycelium of *Mucor*. See also *Rhizopus*, a genus that differs from *Mucor* by its having a smaller sporangium receding from the "head" of the sporangiophore.

**For more information consult:**

Emmans, C.W., C.H. Binford, and J.P. Utz 1963, "Medical Mycology" Lea and Febiger, Philadelphia.

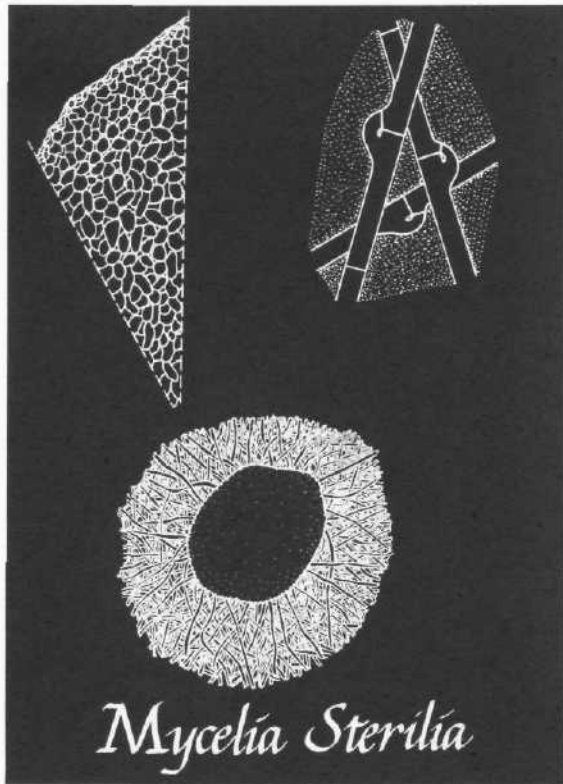

**Figure 211** Drawing of mycelial network showing hyphae with clamp connections and sclerotia-like bodies characteristic of species in the Order Mycelia Sterilia.

Mycelia Sterilia closely resemble mushroom mycelium and may be mistaken for it. Sometimes they form whitish to blackish aggregates of hyphae that are sclerotia-like.

**Microscopic Characteristics:** Having a well developed hyphal network, with or without clamp connections. Only a vegetative mycelial stage is known. Since sporulating structures are absent, fungi in this group reproduce through random fragmentation of hyphae.

**History, Use and/or Medical Implications:** The genus *Sclerotium* noted for two species that parasitize a variety of green plants. Otherwise, the Order is unremarkable.

**Comments:** Mycelia Sterilia is often called a "garbage order" for non-sporulating mycelium of molds that can not be otherwise identified. Either a fungus has lost the ability to produce spores and can exist only in a vegetative state, or it will only produce spores on media of narrow nutritional specifications. In both cases, it is extremely difficult, if not impossible, to identify a fungus that has no visible conidial (sporulating) stage.

There is a white mold that occasionally contaminates agar media and, by default, qualifies for

## MYCELIA STERILIA

**Class:** *Fungi Imperfecti*

**Order:** *Mycelia Sterilia*

**Common Name:** White Mold.

**Habitat and Frequency of Occurrence:** Contaminants fitting into this order occasionally encountered in sterile culture.

**Medium Through Which Contamination Is Spread:** Hyphal fragments airborne.

**Measures of Control:** General hygienic procedures, including the filtration of air through high efficiency particulate air (HEPA) filters, recommended.

**Macroscopic Appearance:** Typically appearing as a fast growing whitish mycelium, fine and or cottony in its growth. Species of

placement into the Order Mycelia Sterilia. Beginning cultivators have been known to propagate these sterile fungi in large quantities thinking them to be mushroom mycelia. This group of contaminants can be very competitive and should not be underestimated.

See also *Mucor*, a mold that has a vigorously growing whitish mycelium on agar media and one that often does not sporulate until it is transferred to grain.



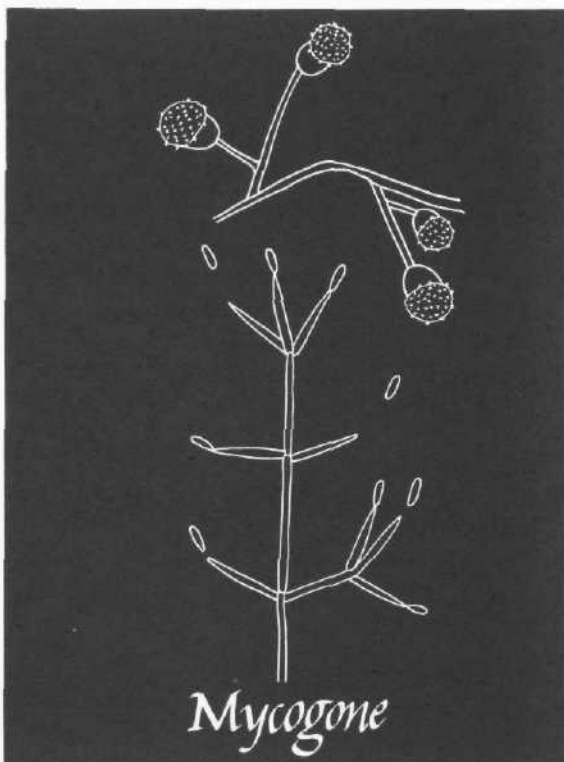

**Figure 212** Drawing of sporulating structure characteristic of *Mycogone*.

## MYCOGONE

**Class:** *Fungi Imperfecti*

**Order:** *Moniliales*

**Family:** *Hyphomycetaceae*

**Common Names:** Bubble; Wet Bubble; White Mushroom Mold; and La Mole.

**Greek Root:** From "myco" or fungal and the suffix "gone" meaning reproductive body. This mold is named in reference to this mold's tendency to parasitize the mushroom fruitbody.

**Habitat & Frequency of Occurrence:** Very common, infecting the mushroom itself and causing significant losses to crops. *Mycogone* naturally occurs in soils from which this aggressive contaminant attacks the mushroom fruitbody. It does not grow well at temperatures lower than 60 °F.

**Medium Through Which Contamination Is Spread:** Mostly through soils; debris (stem butts, etc.); and spent compost. Workers, especially harvesters, are one of the primary vehicles for spore dispersal. Watering infected areas further spreads this contaminant.

**Measures of Control:** Use of clean casing materials; moderation of temperature and adhering to a strict regimen of hygiene, especially between cropping cycles. Without touching the casing, infected mushrooms should be removed from the bed. The localized area is then sprinkled with salt, baking soda or a similar alkaline substance. Do not water until the infected area is treated.

**Macroscopic Appearance:** Appearing as a whitish mold attacking primordia and turning them into a soft whitish ball of mycelia. From the brown and rotting interior of these "bubbles", amber fluid containing spores and bacteria ooze. More mature mushrooms that are afflicted with this disease have a felt-like covering of mycelium and a disproportionately small cap relative to the size of the stem.

**Microscopic Characteristics:** Conidiophores short; generally hyaline; relatively undeveloped; lateral; and altogether similar to the mycelia. Two types of conidia, terminally produced, can occur. The first and most distinctive type of chlamydo-spore is dark, round and two celled with one being

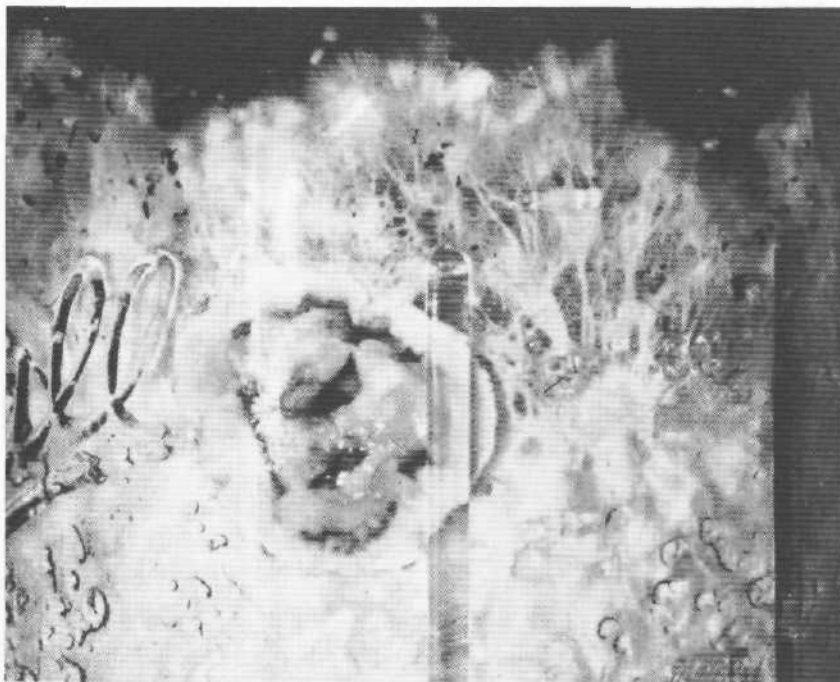

**Figure 213** *Mycogone*, Wet Bubble, on cased rye grain spawn.

large and rough walled, often adorned with short spine-like projections, and which is attached to a smaller cup shaped smooth cell. The second conidial type is smaller, ellipsoid, unicellular and develops apically from the ends of *Verticillium*-like conidiophores.

**History, Use and/or Medical Implications:** Not known to be pathogenic to man or animals.

**Comments:** *Mycogone perniciosa* Magnus is the species in the genus responsible for attacking the mushroom crop. Its mycelia intergrows with mushroom mycelia, according Kneebone (1961). This is a vigorous and resilient contaminant. Its spores are killed at 120° F. when exposed to moist heat (pasteurization) for 24 hours. Isolation of contaminated mushrooms, increasing ventilation, lowering temperature and proper bed cleaning techniques all limit the spread of *Mycogone*. Kneebone recommends the use of chlorinated water (150 ppm) during normal crop watering to impede the germination of its spores.

Harvey et al. 1982, noted that if *Mycogone* appears during the first flush, then its spores were probably introduced via the casing—either at the time of its application or during spawn run through it, a period of about two weeks. Later infestations are more probably spread by flies, workers, air currents or other means.

*Mycogone* is believed by some mycologists to be an imperfect form of *Hypomyces*, an ascomycetous fungus that parasitizes wild mushrooms, especially *Russula* and *Lactarius*.

See also *Verticillium* and *Dactylium*.

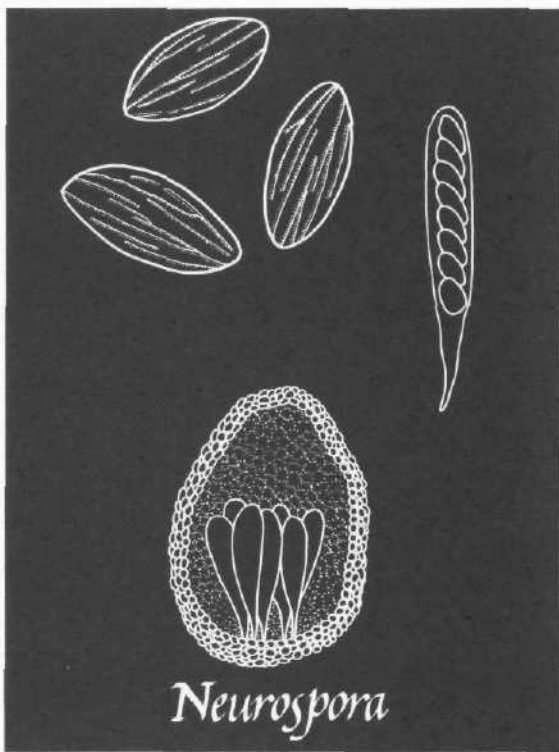

**Figure 214** Drawing of sporulating structure and distinctive spores of *Neurospora*, a pink mold.

## NEUROSPORA

**Class:** *Ascomycetes*

**Order:** *Xylariales*

**Family:** *Sordariaceae*

**Common Names:** Pink Mold; Red Bread Mold

**Latin Root:** From “neuro” meaning nerve and “spora” or spore, in reference to the longitudinal nerve-like ridges running along the axis of the spore.

**Habitat & Frequency of Occurrence:** Commonly to occasionally seen on agar and grain. *Neurospora* is fast growing, sometimes taking only 24 hours to totally colonize a media filled petri dish. It is ubiquitous in nature, occurring on dung, in soils and on decaying plant matter.

**Medium Through Which Contamination Is Spread:** Primarily air; secondarily soils; dung and grains.

**Measures of Control:** Air filtration; incubation of cultures in a sterile environment; thorough sterilization of grain; isolation and destruction of contaminated cultures; and otherwise maintaining the standard regimen of hygiene.

**Macroscopic Appearance:** A fast growing, creeping aerial mycelia that becomes bright pinkish in color with spore maturity.

**Microscopic Characteristics:** Spores distinctively longitudinally ribbed with nerve-like ridges, produced eight at a time (rarely four) in a sac-like organ called an ascus which is in turn enclosed within a ball-like perithecium that can be dark brown to black to pink in color. Its mycelium is usually pigmented, a feature influenced by the type of habitat. Its imperfect form, *Monilia*, consists of a simple mycelia network which branches. *Monilia* segments at the tips from which ellipsoid, oval or globose spores are formed in short chains from the terminal ends. *Monilia* spores are frequently pinkish.

**History, Use and/or Medical Implications:** Not known to be pathogenic to man or animals.

*Neurospora crassa* has become a standard species for studying fungal genetics in culture.

**Comments:** *Neurospora* has an imperfect form represented by the genus *Monilia* which forms spores not in a sac-like envelope but in simple chains at the end of hyphae. (See that genus). *Neurospora* and/or *Monilia* are some of the fastest growing contaminants on grain and agar. The color of this contaminant, in either form, varies substantially. The ability of this organism to mutate into both an asexually reproducing fungus (*Monilia*) and a sexual one (*Neurospora*) is a factor largely determined by nutrition and pH—low pH levels encourage the expression of *Monilia* while higher pH media favor *Neurospora*.

The characteristic pinkish tone and unique spore structure make *Neurospora* an easy contaminant to identify. Since this fungus grows through cotton stoppers or filter discs, a single contaminated jar, though sealed, can spread spores to adjacent spawn jars within the laboratory. This condition is more likely if the filter discs or cotton plugs are the least bit damp; or if the external humidity is high. Furthermore, *Neurospora* spores germinate more readily at elevated temperatures.

The red bread mold belongs to the *Neurospora crassa* complex. The pink mold seen in mushroom culture is most frequently *Neurospora sitophila*, a pernicious contaminant that is difficult to eliminate.

All infected cultures should be removed as soon as possible from the laboratory and destroyed. A thorough cleaning of the laboratory is absolutely necessary. If contamination persists, remove all spawn and start anew. Since *Neurospora* spores are spread via the air, high efficiency Particulate air (HEPA) filters readily eliminate this contaminant.

Refer to the genus *Monilia*, an imperfect form of *Neurospora*.

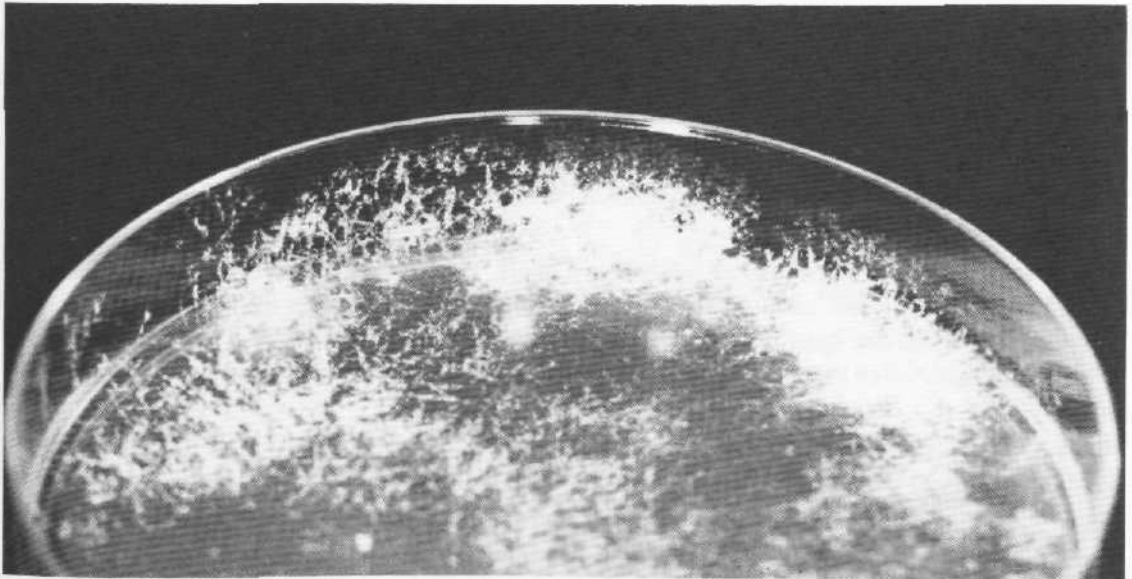

**Figure 215** *Neurospora* contaminating PDA media. Note creeping aerial mycelium.

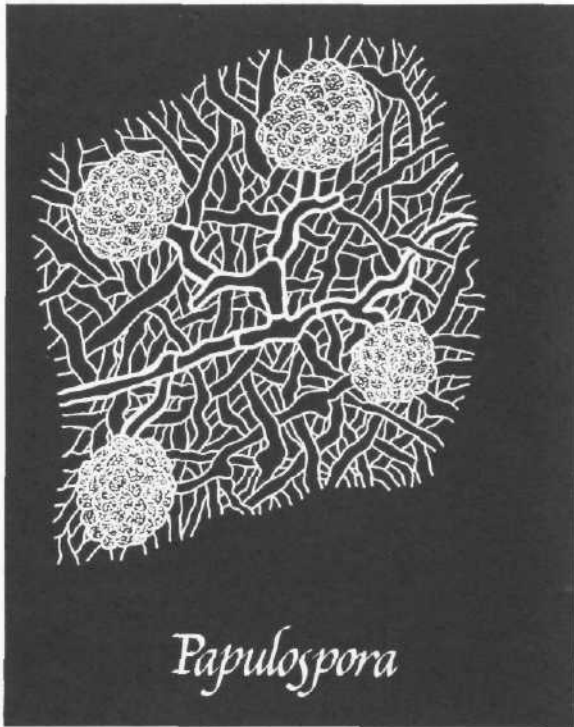

**Figure 216** Drawing of non-sporulating sclerotia-like mycelial mass that is typical of the Brown Plaster Mold, *Papulospora byssina*.

**Measures of Control:** Avoidance of over-composting; proper balancing of moisture in the compost; expeditious removal of old or contaminated compost; steam cleaning of trays; and maintaining good hygiene between crops.

**Macroscopic Appearance:** Dense whitish mycelium, resembling *Scopulariopsis fimicola* (the White Plaster Mold) in the early stages, soon becoming cinnamon brown from small bead-like or "powdery" sclerotia-like balls of cells. The balls of cells are easily seen with a hand lens and are darkly pigmented. Often there is a whitish rim of new growth along the outer periphery of the mycelium.

**Microscopic Characteristics:** True conidia absent, propagating through simple fragmentation of mycelia or through dense spherical sclerotia-like masses of dark cells.

**History, Use and/or Medical Implications:** None known.

**Comments:** *Papulospora* is competitive to mushroom mycelium and can therefore postpone or inhibit fruiting. *Papulospora byssina* Hotson is the brown plaster mold commonly encountered in mushroom cultivation. Colonies of this contaminant can grow up to several feet in diameter if cor-

## PAPULOSPORIA

Class: *Fungi Imperfecti*

Order: *Mycelia Sterilia*

**Common Name:** Brown Plaster Mold.

**Latin Root:** From "papulosus" meaning pimple-like and "spora" or spore. Named in reference to the rounded groups of cells that resemble sclerotia and are characteristic of this genus.

**Habitat & Frequency of Occurrence:** A saprophyte, common on overly mature composts or on compost with excessive moisture. Some species grow directly on the wood used in the construction of the trays and then spread to the beds.

**Medium Through Which Contamination Is Spread:** Primarily air; from spent compost; or from untreated trays that once harbored this contaminant.

rective countermeasures are not taken. It frequently grows on wooden trays or shelves. The Brown Plaster Mold is detrimental to mushroom crops only in the sense that *Papulospora* usurps valuable nutrients that would otherwise be available to the mushroom mycelium. According to Atkins (1974), wet, compact and overly mature compost is likely to favor these contaminants.

Because no conidial (spore producing) phase is known, it has been placed in the "garbage" order of little understood fungi, the Mycelia Sterilia.

See also *Botrytis* and *Scopulariopsis*.

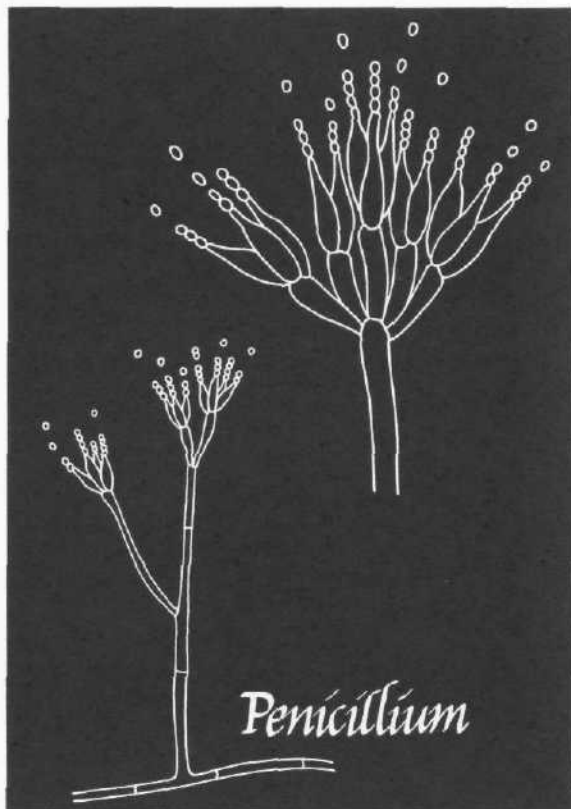

Figure 217 Drawing of sporulating structure characteristic of *Penidllium* molds.

## PENICILLIUM

**Class:** *Fungi Imperfect!*

**Order:** *Moniliales*

**Family:** *Eurotiaceae*

**Common Name:** The Bluish Green Mold.

**Latin Root:** From “*penicillum*” meaning a brush-like tuft of hairs, so named in reference to the shape of the sporulating body.

**Habitat & Frequency of Occurrence:** An extremely common contaminant. Although not as prevalent in nature as *Cladosporium*, *Penicillium* is the **most** prevalent of indoor contaminants, a fact that is undoubtedly related to human eating habits. *Penicillium* species abound on foodstuffs **such** as fruits, cheeses and stored grains. Many species prefer habitats with an acid pH. Penicillia are occasional to frequent on under-developed mushroom compost, casing soil and on discarded mushroom debris.

**Medium Through Which Contamination Is Spread:** Primarily through the air, although stored grain and other foodstuffs, as well as humans are the most frequent carriers of this mold.

**Measures of Control:** Air filtration; removal of waste products; isolation of contaminated cultures; and maintenance of a high level of hygiene.

**Macroscopic Appearance:** Appearing as a granular or powdery bluish green mold, often with a broad whitish rim of new growth. Some species, less frequently encountered, are whitish, yellowish or even reddish in color. Many **species** exude droplets of fluid from their surfaces having antibiotic properties.

**Microscopic Characteristics:** Conidiophores arising singly, long, and branching **near** the apex into short chains of globose, green, dry conidia. Compared to mushroom spores, the conidia of *Penicillia* are minute, measuring only 2-4 microns in diameter.

**History, Use and/or Medical Implications:** In 1928-1929 while Dr. Alexander Fleming was studying *Staphylococcus aureus*, he noticed that a green mold contaminant inhibited his cultured

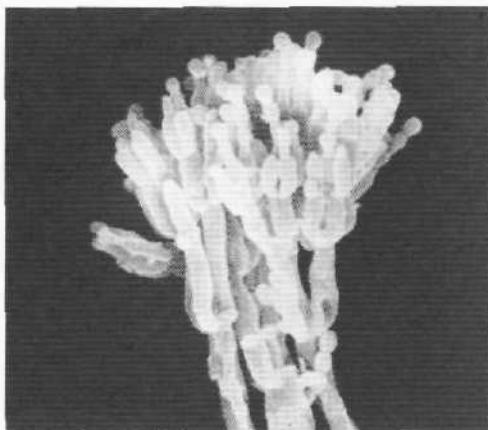

**Figure 218** Scanning electron micrograph of *Penicillium*.

bacteria when the two grew in close proximity. A fluid that was being exuded from the fungus caught his curiosity. Upon reporting his finding, colleagues later found the fluid contained a powerful new antibiotic which was named penicillin. He had, in fact, cultured *Penicillium notatum* Westl. Currently penicillin is commercially produced by high yielding strains of *Penicillium chrysogenum* Thom. Through its use, millions of people have been cured of illnesses that were previously untreatable. From the widespread use and abuse of this drug, however, new, more virulent and penicillin resistant strains of bacteria have evolved.

From the production of steroids to the making of roquefort cheese (by *Penicillium roquefortii*), this genus is resplendent with species of proven value to man. Few, if any, are pathogenic.

Comments: Since the high count of *Penicillium* spores indoors is directly traceable to decomposing foodstuffs, one can reduce the prevalence of this contaminant by simply following good hygienic practices. *Penicillium*, a prolific spore producer, is an ubiquitous fungus. It is probably the most common contaminant seen in the laboratory. Although *Penicillium* can attack compost, casing soil and mushroom debris, it is not as prevalent as *Trichoderma* in these habitats. Other green molds, similar in appearance, are *Cladosporium* and *Aspergillus*.

*Penicillium* sometimes contaminates poorly prepared compost or spawned compost that has undergone secondary heating. Here, grain kernels formerly colonized by mushroom mycelium become susceptible to weed molds such as *Penicillium* and *Doratomyces* and then spread onto the compost and/or casing soil.

Differing from *Aspergillus* and *Trichoderma* in the shape of the conidiophore.

**For further information:**

"The *Penicillia*" by Raper and Thom (1949) who recognized 138 species at the time of publication.

See Color Photograph 20.



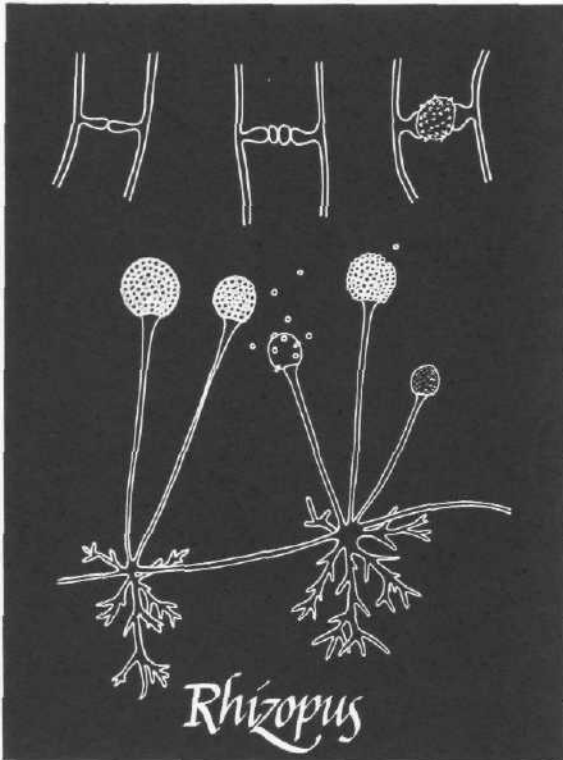

**Figure 219** Drawing of asexual sporangio-phore and sexual zygosporium of *Rhizopus*.

## RHIZOPUS

**Class:** *Zygomycetes*

**Order:** *Mucorales*

**Family:** *Mucoraceae*

**Common Names:** Bread Mold; The Pin Mold,

**Latin Root:** From the prefix "rhizo", pertaining to roots, and the suffix "pus" or foot, in reference to the rhizoids at the base of the sporangiophore that is characteristic of some species in this genus.

**Habitat & Frequency of Occurrence:** A saprophyte, commonly seen in both agar and grain culture. *Rhizopus* naturally inhabits dung and soils and is a decomposer of dead plant and animal matter. Within the home, this contaminant is most often seen on old bread or on poorly stored grain and fruits.

**Medium Through Which Contamination Is Spread:** Primarily air.

**Measures of Control:** Air filtration; strict adherence to general hygienic practices; and steam sterilization of grain and agar media.

**Macroscopic Appearance:** Similar to *Mucor*. When sporulating, *Rhizopus* appears as a dense mat of tall, aerial, vertically oriented hyphae upon which sit dark grey to grey black heads. It resembles a forest of pins.

**Microscopic Characteristics:** A creeping hyphal network that gives rise to individual, vertically oriented stalks that are unbranched and at whose base distinct rhizoids can be attached. The apex is swelled into a vesicle upon which a dark spherical body (sporangium) rests. This sporangium does not fully envelope the sporangiophore. Hence, the sporangiophore swells before contacting the sporangium. The sporangium is a mass of spores within a thin envelope of tissue that soon disintegrates and frees the asexual spores. Joining these individual sporangiophores are long interconnecting mycelial veins called stolons. Mating can also occur between two sexually complementary hyphae and results in the formation of a globose reproductive body, a zygosporium. (See Fig. 219). Its mycelia lacks distinct cell walls.

History, Use and/or Medical Implications: In itself, not a pathogen to man. Reports in The medical literature have in the past blamed *Rhizopus* for zygomycosis when in fact other related genera—*Absidia* and *Mucor*—were responsible.

*Rhizopus stolonifer*, the black bread mold, is also utilized in the commercial production of fumaric acid and cortisone. Other species in the genus secrete assorted alcohols and acids as metabolic waste products.

Comments: Along with *Aspergillus* and *Penicillium*, species of this genus are the primary contaminants of grain spawn. *Rhizopus* is very rapid growing, and is called the Pin Mold for the shape of the spore producing body. *Rhizopus stolonifer* (= *Rhizopus nigricans*) is called the Black Pin Mold and can elevate the substrate temperature from room temperature to the 95-104° F. range. At this level, the populations of the true thermophiles increase dramatically, further heating up the host substrate to temperatures lethal to the mushroom mycelium.

See also *Mucor*, a mold that is closely related to *Rhizopus*, but whose sporangium completely covers the apex of the sporangiophore.

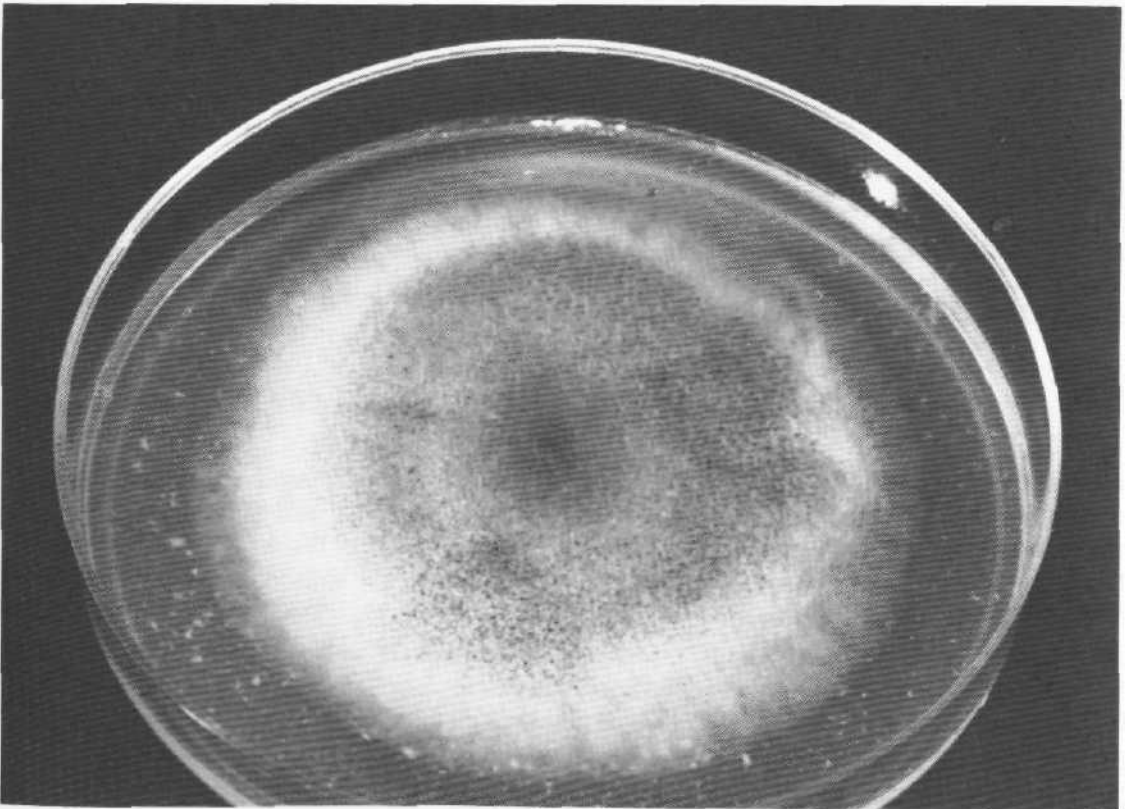
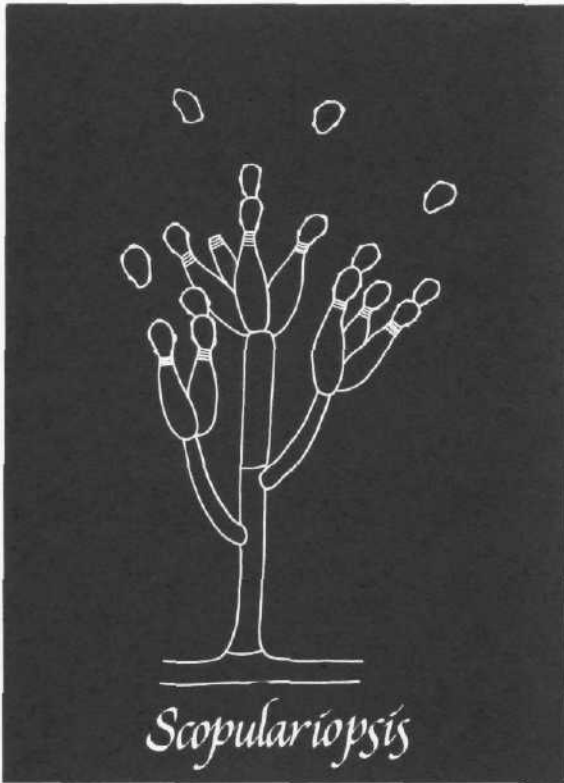

Figure 220 *Rhizopus*, the Black Pin Mold, on malt agar.



**Figure 221** Drawing of sporulating structure typical of *Scopulariopsis*.

## SCOPULARIOPSIS

**Class:** *Fungi Imperfecti*

**Order:** *Moniliales*

**Series:** *Annelosporae*

**Common Names:** White Plaster Mold; Flour Mold.

**Latin Root:** From "scopulatus" meaning broom-like or brush shaped, in reference to the structure of the sporulating reproductive body.

**Habitat & Frequency of Occurrence:** A saprophyte, occasionally seen in composts that have been over-watered or are too high in nitrogen. *Scopulariopsis* also forms on the casing during the fruiting cycle. It naturally grows in soils, on hay, on rotting leaves and on other decaying plant material including grain. This group of molds generally prefer an alkaline pH.

**Medium Through Which Contamination Is Spread:** Primarily airborne spores, spent compost and insects; and from materials previously in contact with this contaminant that were not thoroughly cleaned before use.

**Measures of Control:** Proper preparation and sufficient air during Phase II composting discourages this fungus. Atkins (1974) reported that excessive moisture and subsequent anaerobic pasteurization were the two main factors contributing to the spread of the White Plaster Mold. Before filling, the addition of gypsum to an overly wet compost will bind loose water, a condition favorable to this mold.

**Macroscopic Appearance:** Circular colonies of densely matted, whitish mycelia; with age developing slight pinkish tones. This mold often appears as "splotches", mostly on the compost bed and to a lesser degree on the casing soil.

**Microscopic Characteristics:** Conidiophores short, soon branching, delineating into several elongated cells which then give rise to short chains of globose, hyaline, finely warted, dry conidia that measure 5-8 x 5-7 microns. Annular zonations are present at the junction of the sporogenous cells and the first spore in the conidial chain. Terminal cells in the chain are the oldest and typically

the largest. The conidiophores generally resemble that of *Penicillium* and thus are described as pencillate, or brush shaped.

**History, Use and/or Medical Implications:** One species toxic to humans: *Scopulariopsis brevicaulis* (Saccardo) Brainer. This species usually attacks tissue already diseased by other microorganisms. It is an improbable threat to the health of mushroom cultivators.

**Comments:** *Scopulariopsis fimicola* is the White Plaster Mold seen on compost beds. It is very detrimental to the growth of mushroom mycelia. Its presence is usually an indication of a short, wet and over-mature compost. This condition predisposes the compost to a difficult Phase II with dense anaerobic areas, ammonia-lock and consequently high pH levels. All these factors contribute to the growth and spread of *Scopulariopsis fimicola*, the species of White Plaster Mold most frequently seen in mushroom culture.

Contamination can also arise from within the mushroom house if there has been a prior history of problems with this contaminant and if strict contamination control procedures have not been instigated. Not surprisingly, one often finds *Scopulariopsis* with the Inky Cap (a *Coprinus* species) which is also associated with residual ammonia in composts.

See also *Papulospora* (*P. byssina* Hots.), a genus containing the Brown Plaster Mold whose early stages of growth resemble the White Plaster Mold.

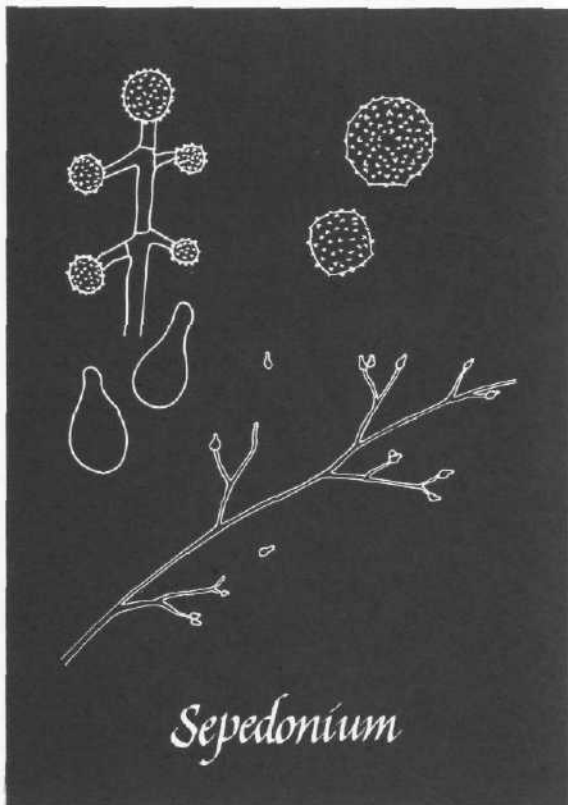

Figure 222 Drawing of sporulating structure and flask shaped conidia.

growing room; the expeditious removal of spent compost; and the thorough disinfection of wooden compost containers.

**Macroscopic Appearance:** On malt agar and on rye grain appearing as a fast growing whitish mold, very similar to cottony mushroom mycelia and frequently mistaken for it. On compost it is a fine white mold which with age becomes yellowish to golden yellow from spore production. It is not as prolific a spore producer as the powdery *Trichoderma*. If spores are not produced at all, the mycelia remains whitish. This mold attacks composts that otherwise have been properly prepared for mushroom growing.

**Microscopic Characteristics:** Two types of spores formed. The more obvious are large, globose chlamydospores ornamented with short spines and similar to those of *Mycogone*; except in this genus a hemispheric foot cell, shaped like a teacup is absent. Conidiophores are simple, relatively undeveloped, resembling mushroom mycelium and not easily distinguished from it except that they lack clamps. Globose to vase shaped conidia develop terminally at the end of these branches, either singly or in loose clusters.

## SEPEDONIUM

Class: *Fungi Imperfecti*

Order: *Moniliales*

Series: *Aleurisporae*

**Common Names:** Yellow Mold; White Mold.

**Habitat and Frequency of Occurrence:** Occasionally to frequently encountered on agar; more common on compost; and parasitic on wild mushrooms (both Basidiomycetes and Ascomycetes).

**Medium Through Which Contamination Is Spread:** Primarily through the air, but also from spent compost.

**Methods of Control:** Air filtration; strict maintenance of hygiene in the laboratory and

**History, Use and/or Medical Implications:** Some species possibly toxic. It has been suggested that this mold secretes a sweet odor nauseous to some mushroom workers and possibly the cause of a little understood respiratory illness. Not much is known.

**Comments:** *Sepedonium* spores are noted for their heat resistance. It is a whitish mold until the yellow conidia are produced. On malt agar media, *Sepedonium* is fast running, and out-grows most mushroom mycelia. When the two fungi grow within close proximity to one another, a line of inhibition usually develops between the two. If conidiospores or chlamydospores are not produced, this mold is difficult to identify. The conidiophores are indistinct, very much resembling its own mycelium. From the authors' experience this contaminant is a vigorous competitor on agar media. Its appearance necessitates a thorough cleaning of the laboratory and spawn incubation environment. If this mold contaminates grain spawn and goes undetected, use of this spawn in subsequent inoculations would be disastrous.

The second site of contamination is horse manure/straw compost where it most frequently appears during spawn run. Only detrimental when large outbreaks occur, *Sepedonium's* presence on compost can be traced to insufficient pasteurization or spent compost residues in the trays or shelves. Although not regarded as a serious competitor on mushroom compost, *Sepedonium* is another fungus believed to be a food source for mites (Kneebone, 1961).

*Sepedonium*, like *Mycogone*, is an imperfect state of *Hypomyces*, a common parasite on mushrooms. In the wild, *Sepedonium chrysosperma* parasitizes *Boletus* species (particularly *B. chrysenteron*) and causes them to abort. The chlamydospores of *Sepedonium* are generally similar to *Mycogone*.

See also *Mucor* and *Mycelia Sterilia*, two fast running whitish molds on agar media.

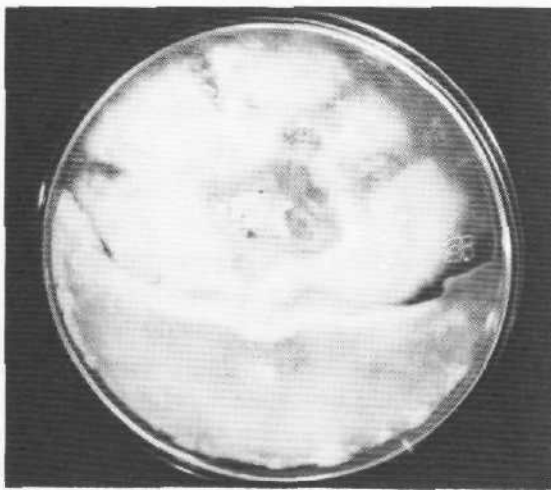

**Figure 223** *Sepedonium* mold competing with *Psilocybe cubensis* mycelia on malt agar media.

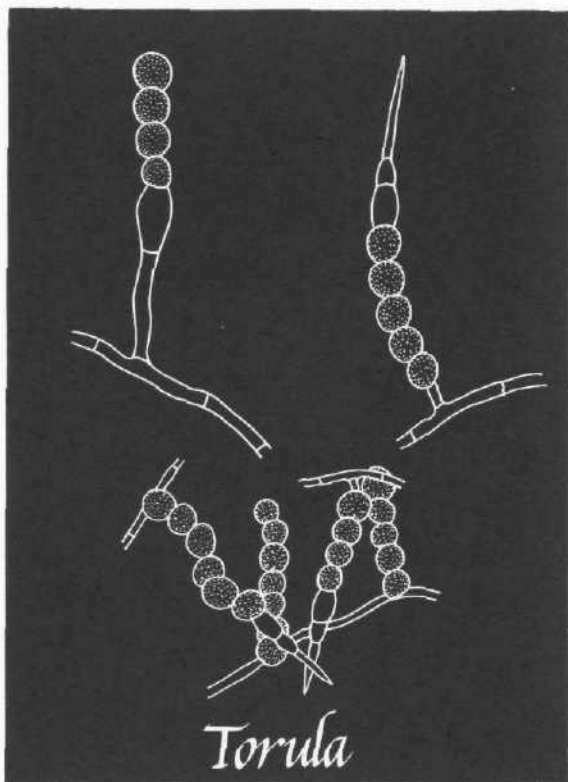

**Figure 224** Drawing of the sporulating structure of *Torula*, the Black Yeast.

## TORULA

**Class:** *Fungi Imperfecti*

**Order:** *Moniliales*

**Family:** *Dematiaceae*

**Common Name:** Black Yeast (*Torula nigra*).

**Latin root:** From the same root as the adjectival "torulosus", meaning cylindrical shaped with bulges and constrictions at regular intervals, chain-like.

**Habitat and Frequency of Occurrence:** Saprophytic, common. Many thermophilic species participate in the decomposition of straw and manure in the making of mushroom composts. Although *Torula* is rarely seen in agar culture, its cousin *Rhodotorula*, a red yeast, is frequently seen.

**Medium Through Which Contamination Is Spread:** Primarily an airborne contaminant; secondarily transmitted through compost.

**Methods of Control:** None generally needed or desired. *Torula* is a beneficial, thermophilic microorganism thriving in the 115-125° F. range.

**Macroscopic Appearance:** Whitish at first, then grayish, soon dark brown or jet black with spore production. As *Torula* matures, the mycelium becomes covered with a mass of spores that give it a soot-like appearance. On compost, this fungus appears similar to *Humicola*.

**Microscopic Characteristics:** Mycelium colorless or slightly pigmented. True conidiophores are lacking. Hyphae abruptly terminate into conidia which are ovoid, translucent, dark brown, smooth and produced in branched or unbranched chains by either of two methods. In one form, the more mature spores of a conidia! chain develop apically, with the younger spores arising from the spore closest to the hyphal branch. (This is called basipetal development). In a second form, conidia can develop by simple budding from the tips of a hypha, in a yeast-like fashion. The budding hypha narrows towards the apex into immature spores and finally terminates with an attenuating tail. Freed are conidia found singly or attached several at a time.

**History, Use and/or Medical Implications:** Not thought to be pathogenic. Confusion with *Cryptococcus* has in the past given *Torula* an undeserved pathogenic reputation. *Cryptococcosis* in the medical literature is often though incorrectly termed Torulosis.

**Comments:** *Torula*, like *Humicola*, is an ally to the mushroom compost maker, converting ammoniac nitrogen into protein usable to the mushroom. *Torula thermophila* Cooney & Emerson is the species most frequently seen in composting straw and manure. Originally isolated from chicken droppings, this species is a true thermophile with a temperature range from 73-136 ° F., and an optimum of 104 ° F. The *Torula* genus is known for a number of thermophilic species that survive the pasteurization process and flourish at standard Phase II conditioning temperatures (118-125 ° F). When pasteurized compost is cooled down to room temperature, this fungus is rendered inactive and in turn becomes a food source for the mushroom mycelium.

*Rhodotorula* reproduces very similarly to *Torula*. It is known as the Red Yeast, commonly contaminating agar cultures. *Rhodotorula glutinis*, a common soil inhabitant, may play an important role in the reproductive cycle of the common Chantarelle mushroom, *Cantharellus cibarius*. Pure cultures of Chantarelles have been difficult to obtain from wild specimens. And, Chantarelle spores do not germinate using standard laboratory techniques. In 1979, a Swedish mycologist named Nils Fries discovered that, in the presence of *Rhodotorula glutinis* and activated charcoal, *C. cibarius* spores readily germinate. Pure cultures of Chantarelles, once nearly impossible to obtain, are now feasible. Other related yeasts may have a similar stimulatory effect on various mushrooms species currently not prone to cultivation.

*Torula* species, as with most yeasts, are separated from one another largely by chemical means.



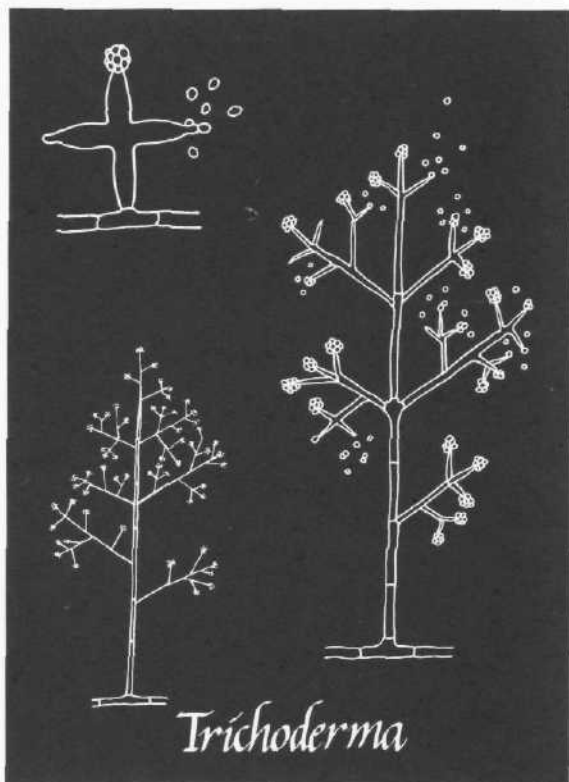

Figure 225 Drawing of conidia and sporulating structure typical of *Trichoderma*.

## TRICHODERMA

**Class:** *Fungi Imperfecti*

**Order:** *Moniliales*

**Family:** *Moniliaceae*

**Common Names:** Forest Green Mold; Green Mold; and Trichoderma Blotch.

**Greek Root:** From "trichos" meaning hairy and "derma" or skin.

**Habitat & Frequency of Occurrence:**

Very common on compost, casing soil and to a lesser degree on grain and agar. *Trichoderma* often parasitizes mushrooms under cultivation and can inhibit or reduce fruitings. Many species grow on wood or woody tissue and are abundant in peat. *Trichoderma* frequently grows on the wooden trays holding compost.

**Medium Through Which Contamination Is Spread:** Primarily an airborne contaminant when contaminating agar or grain cultures. On casing soils, it is introduced through the peat or humus. *Trichoderma* is often spread during harvesting, bed cleaning or watering. Species in this genus generally prefer an acid pH in the 4-5.5 (6) range.

**Measures of Control:** Careful picking; disposal of dead and diseased mushrooms; lowering of humidity levels; lowering carbon dioxide and increasing air circulation to eliminate dead air pockets. Use of clean casing materials lacking undecomposed woody tissue lessen the chance of *Trichoderma* contamination. Isolated outbreaks of *Trichoderma* can easily be contained by one of several methods. Since *Trichoderma* thrives in acid habitats, raising the pH of the surrounding soil inhibits further growth. Perhaps the simplest way to raise pH is to cover the infecting colony with salt, sodium hypochlorite or sodium bicarbonate (baking soda) or a solution thereof. Recognizing and treating this fungus in its earliest stages, before many spores are produced, greatly reduces the risk of satellite colonies spreading throughout the growing room. Mushrooms afflicted with *Trichoderma* should be carefully isolated. All items coming in contact with it (tools, workers, etc.) should be resanitized. Steam pasteurization at 160°F. for one hour effectively kills the spores of this fungus.

**Macroscopic Appearance:** A cottony mold, growing in circular colonies on the casing soil or on compost; grayish and diffuse at first; rapidly growing; and soon forest green from spore production. On malt agar colonies of *Trichoderma* have an aerial, cottony and brilliant forest green mycelium whereas *Penicillium* has an appressed, granular and blue green mycelium. Some infrequently encountered species are whitish or yellowish, but the majority of those seen in mushroom culture are greenish shaded.

Parasitized mushrooms have dry brownish blotches or sunken lesions on the cap or stem. They are often enveloped by a fine downy mildew that may eventually become greenish from spore production, and are grossly misproportioned.

**Microscopic Characteristics:** Conidiophores clear, profusely branched upon whose ends small bunches of ovoid greenish pigmented, smooth spores are borne. In many species uniquely shaped sporogenous cells are present roughly resembling bowling pins and arranged as triads. After squashing a sample for viewing under the microscope, the conidiophores readily disassemble and are difficult to recognize. The freed conidia, however, are not arranged in linear chains as commonly seen in *Aspergillus* and *Penicillium*, but are in loose clusters or are scattered as individuals. A

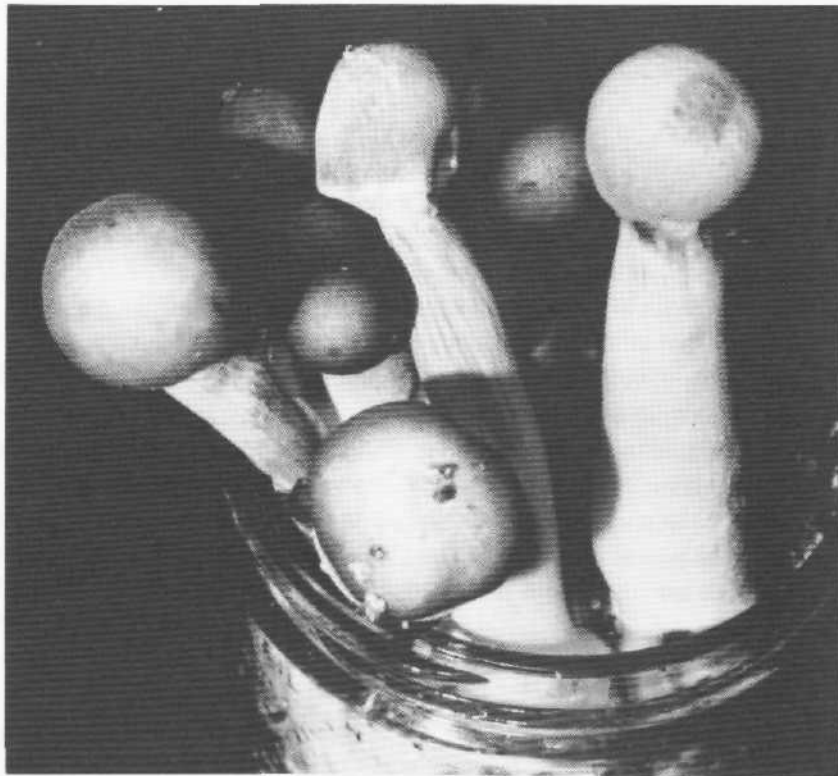

Figure 226 *Trichoderma*-like mold parasitizing *Psilocybe cubensis*.

most distinctive feature is that the *conidia* are encased in a mucus-like substance, making the spores sticky. Spores measure 3-5 x 3-4 microns.

**History, Use and/or Medical Implications:** Not known to be pathogenic. One industrial application utilizes *Trichoderma*, *Penicillium* and *Cladosporium* to precipitate precious metals such as gold and platinum from solutions. The process is being patented.

**Comments:** In cased grain culture, *Trichoderma* is the most frequently encountered contaminant on the casing layer and usually originates there. Upon casing, spores harbored in the peat infect exposed grain kernels and sporulate. The contaminated kernels become a platform for further contamination. The mold then spreads through the casing layer until it breaks through to the surface of the casing layer. Also, *Trichoderma* is prone to casings with undecomposed woody tissue and those incorporating potting soils. *Trichoderma* is also caused by excessively wet casings applied to sterile grain spawn.

*Trichoderma* is an ubiquitous fungus that is encouraged by improperly adjusted environmental parameters. Conditions of excessively high and prolonged humidity in combination with stagnant air and high carbon dioxide levels tip the ecological balance of the casing soil's micro-ecology in favor of this contaminant. Once *Trichoderma* populations bloom, this mold quickly infects newly formed primordia and developing fruitbodies which become deformed. This pathogen also grows on discarded mushroom debris, particularly stem butts.

Afflicted mushrooms have brownish specks or lesions on the stem, especially near the base or apex. A fuzzy mycelium similar to *Verticillium* may be present on the cap. These lesions are dry, whereas the blotches caused by bacteria tend to be moist. The growth of the fruitbody is abruptly arrested by this mold. Under extreme conditions this mold sporulates directly on the mushroom, becoming green in color. Adjacent mushrooms, newly formed pinheads and subsequent crops need not be affected if air circulation is increased to proper levels and if humidity is decreased to within tolerable limits (3-5 exchanges of air per hour while maintaining 85-92% humidity). *Trichoderma* is alleged to secrete toxins that inhibit mushroom primordia formation and growth.

Another problem with *Trichoderma* is that its spores are utilized by red pigmy mites as food. *Trichoderma* spores are sticky and attach to anything coming in contact with them. In this way, mites further aid the spread of *Trichoderma* contamination. And, soon after an outbreak of *Trichoderma*, it is not unusual to see a population explosion of mites.

Most notable are *Trichoderma viride* (a synonym of *Trichoderma lignorum*), an early appearing mold with roughened spores and *Trichoderma koningii*, a smooth spored mold seen later in the cropping cycle. Both are mushroom pathogens.

See *Verticillium*, a mold with similar symptoms when attacking fruitbodies.

See Color Photograph 22.

---

## TRICHOTHECIUM

**Class:** *Fungi Imperfecti*

**Order:** *Moniliales*

**Family:** *Moniliaceae*

**Common Name:** Pink Mold.

**Greek Root:** From "trichos" meaning hairy and "theke" meaning sac or capsule.

**Habitat and Frequency of Occurrence:** For the most part, a saprophyte, rarely encountered in spawn making even though it is one of the many microflora associated with grain. *Trichothecium* is an occasional contaminant in agar culture and in poorly prepared or immature composts.

**Medium Through Which Contamination Is Spread:** Primarily an airborne contaminant.

**Measures of Control:** Air filtration and maintenance of good hygiene in the laboratory.

**Macroscopic Appearance:** Mycelium initially whitish; soon pinkish with spore production; and typically slow growing on malt agars. *Trichothecium* is a powdery *Penicillium* type mold.

**Microscopic Characteristics:** Conidia measuring 12-18 x 4-10 microns; colorless to brightly colored; two celled; pear shaped, ellipsoid or ovoid; borne in clusters with the basal cell being smaller than the terminal one; and positioned at the apex of tall, thin, unbranched, but septate conidiophores. Spore bunches are attached to one another either in a chain-like fashion or in loose groups but not lineally.

**History, Use and/or Medical Implications:** One mold notable. *Trichothecium roseum* Link ex Fr. secretes an antibiotic (trichothecin) that is toxic to bacteria, fungi and animals.

**Comments:** More frequently seen in the course of agar culture than on grain, this contaminant can become a formidable problem if not detected early, and if large spore populations are permitted to develop within the laboratory.

Also occurring on compost and occasionally on the casing soil, particularly where nitrogen

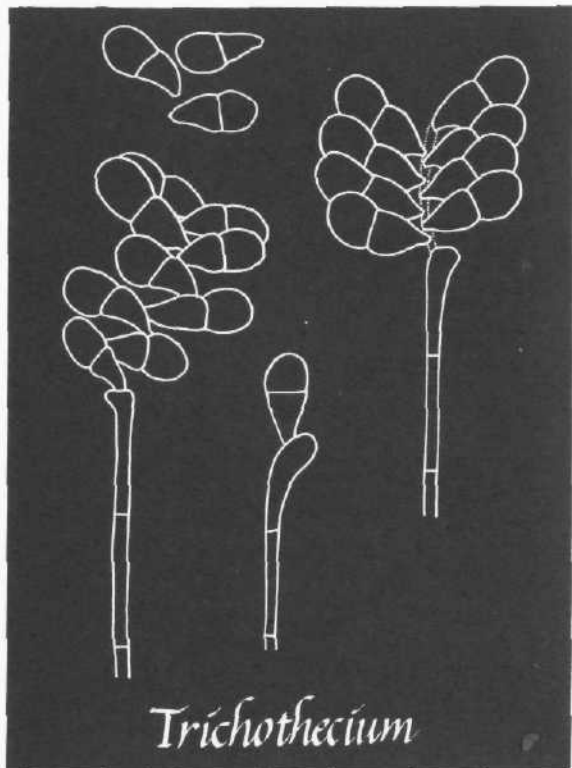

Figure 227 Drawing of conidia and sporulating structure of *Trichothecium*.

enriched compounds have not been converted into protein usable To the mushroom mycelium. By itself it is not strongly inhibitory to mushroom mycelium, but thrives in habitats generally unsuited for good mushroom growth. Adhering to good compost practices and following standard hygienic procedures prevents This fungus from occurring.

See also *Fusarium*, a genus containing several pinkish colored contaminants and *Geotrichum*, a genus known for the Red Lipstick molds.

## VERTICILLIUM

**Class:** *Fungi Imperfecti*

**Order:** *Moniliales*

**Family:** *Moniliaceae*

**Common Names:** Dry Bubble; Brown Spot; and Verticillium Disease.

**Latin Root:** From "verticillus" meaning whorled or having branches on the same plane, in reference to the shape of the conidophore.

**Habitat & Frequency of Occurrence:** A common parasite of the fruitbody. *Verticillium* is promoted during cropping under conditions of excessive humidity combined with inadequate air circulation. *Verticillium* grows within a broad temperature range although warmer temperatures (62 °F. and above) are preferred.

Singer (1961) reported an optimum of 72 °F. *Verticillium* abounds in soils and is introduced into the growing environment via the materials composing the casing.

**Medium Through Which Contamination Is Spread:** Primarily transmitted from one infected region to another by mushroom harvesters, flies and insects. Watering infected mushrooms further spreads *Verticillium* spores.

**Measures of Control:** General hygiene maintenance; proper picking and cleaning practices; removal or isolation of infected cultures; increasing air circulation; lowering of humidity; and elimination of flies and mites. If *Verticillium* is evident before a crop is harvested, carefully pick the infected mushrooms, seal them in a plastic bag and leave the growing room with minimal contact with unaffected areas. *Verticillium* spores are highly viscous and are best transmitted by motile hosts, especially mites and other insects. Never water an infected bed until the diseased mushrooms have been removed and the infected zones have been salted with alkaline buffer (baking soda, sodium hypochlorite).

**Macroscopic Appearance:** Slightly infected mushrooms characterized by brown colored spots or

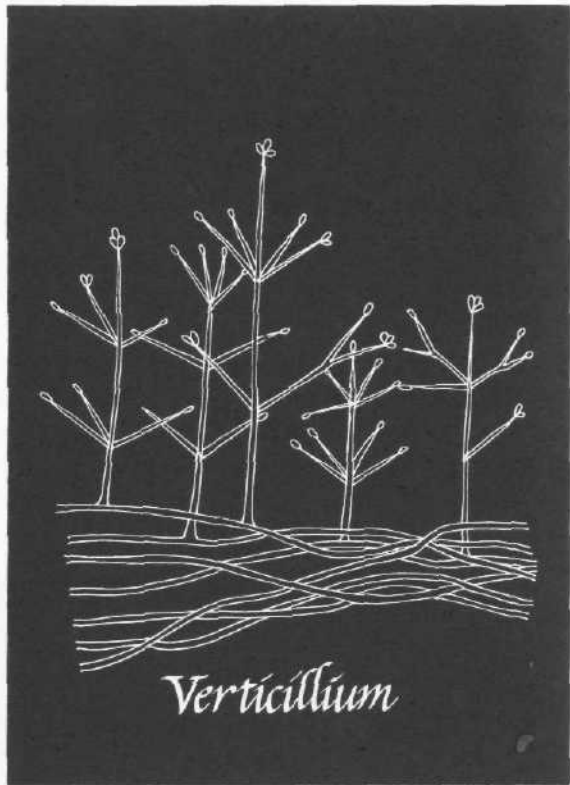

**Figure 228** Conidia and sporulating structure of *Verticillium*.

streaks on the basal or upper regions of the stem and on the caps of developing primordia. These spots become grayish colored from spore production. Afflicted mushrooms often bend towards the side that is infected. If the mushrooms do develop at all, they are typically tilted to one side or the other. *Verticillium* attacks developing fruitbodies—the more severely infected are grossly malformed, especially young primordia which are turned into sclerotia-like balls of amorphous whitish mycelia. More mature but diseased mushrooms have a deformed pileus, sometimes with a "hair lip", and frequently with a downy grayish mycelium over the cap. The stem can be covered with a downy mycelium and often vertically splits, roughly resembling a peeled banana. The cap becomes disproportionately small relative to the fatter than normal stem. The overall texture of the mushroom is dry and leathery.

When this mold attacks *Psilocybe cubensis*, there are several additional characters worthy of note. Parasitized *P. cubensis* caps frequently become plane at an early stage. The stem becomes swollen and hollow, narrowing radically towards the apex. Only in an extremely humid environment does a downy mildew develop over the cap and stem surface. The "Verticillium spots" so commonly reported by growers of *Agaricus*, a white mushroom, are more accurately called "Verticillium streaks" on *P. cubensis*, a mushroom with a brownish cap and a whitish stem.



Figure 229 *Verticillium* attacking *Psilocybe cubensis*.

Microscopic Characteristics: Conidia hyaline; unicellular; ovoid to ellipsoid; minute, measuring 1-3 x 1-2 microns; borne singly or in small groups at the tips of narrow branches that whorl from a central trunk at regular intervals. Conidiophores are slender and relatively tall.

History, Use and/or Medical Implications: Apparently innocuous, no pathogenic species are known.

Comments: *Verticillium* is the most common fungal disease parasitizing the mushroom crop and the bane of both small and large scale growers. One misfortune of losing an early flush to *Verticillium* disease is the increased probability of other diseases appearing. Split stems open the mushroom up to attack by numerous insects and other pathogens. Not surprisingly, the sciarid fly is a vector for the spread of *Verticillium* spores from parasitized mushrooms to healthy ones. It becomes clear that if conditions are right for *Verticillium*, the conditions are right for other molds. The cultivator may soon have to deal with not one contaminant, but many.

*Verticillium malthousei* Ware is synonymous with *Verticillium fungicola*. Both are "brown spot" fungi that envelope the mushroom with a fine grayish mycelium and cause brownish lesions on their surfaces. *Verticillium albo-atrum* is another species in mushroom culture, although not as frequently seen.

*Verticillium* is specifically a casing related contaminant that parasitizes the mushroom fruit-body. Other molds that parasitize the mushroom are *Dactylium* and *Trichoderma*. They can be separated microscopically. *Dactylium* spores are two celled and quite large (20 microns long) while those of *Trichoderma* and *Verticillium* are single celled and much smaller (4 x 5 microns and 2-3 microns, respectively).

An easy method for the home cultivator to distinguish *Verticillium* infection from *Trichoderma* is to plate out the suspect mold on malt agar media. If the mold is *Trichoderma*, forest green colonies of mycelium will form. Other than green colonies of mycelium suggests the contaminant be *Dactylium* or *Verticillium*,

Usually one sees *Trichoderma* blotch simultaneous to or after the occurrence of green mold colonies on the casing layer. If there is no evidence of green mold on the casing layer and the mushrooms display these symptoms, then the mold is probably *Verticillium* or *Dactylium*. *Dactylium* can be distinguished from *Verticillium* by its locus and manner of infection. *Dactylium* is a grey, aerial mold, fast growing and obvious on the casing. *Verticillium* is primarily evident on the fruit-body and scarcely seen on the casing.

Steane (1979) reported that *Agaricus bitorquatus*'s seemed especially resistant to *Verticillium* disease whereas *Agaricus brunnescens* was more susceptible to it. Furthermore, he noted that farms regularly suffering from this disease could greatly reduce the level of infection by intermittently growing *A. bitorquatus* between *A. brunnescens* crops.

A saprophyte and parasite causing "wilt disease" of many plants, particularly garden vegetables, *Verticillium* is abundant in most soils. Some *Verticillium* species are endoparasitic to nematodes—their spores germinate in the mouth tubes of the nematode with the resulting mycelia quickly digesting the organism from within. Other pathogens that have similar symptoms to one or more of the various stages of *Verticillium* are: *Dactylium*; *Trichoderma*; *Mycogone*; and Virus.



# CHAPTER XIV THE PESTS OF MUSHROOM CULTURE



Figure 230 Red Pepper Mites swarming on *Agaricus brunnescens*.

## MUSHROOM FLIES

**M**ushroom flies and midges are present in nature wherever fungi are found. Attracted by the odor of decomposing manure and vegetable matter, as well as the smell of growing mycelium, these insect pests zero in and lay their eggs on or near the mycelium and fruitbodies. Under proper conditions these eggs hatch. But it is the larvae that do the extensive damage to the mushroom plant, either by directly feeding on the mycelial cells or tunneling through the mushroom fruitbody. Because of the concentration of attractive odors, a commercial mushroom farm is always under siege by these pests. To insure insect free crops, certain measures are necessary. Unfortunately the bulk of these control measures involve insecticides, an approach not recommended by the authors. The use of insecticides is not only costly and hazardous to human health, but also represents a short term solution of a symptom rather than the solution of the problem itself. The answer to disease and pest control in mushroom growing is strict hygiene for which there can be no substitute.

### Fly Control Measures

1. Pasteurization periods and temperatures must be sufficient to kill all stages of insect growth—140 °F. for 2 hours in composts or other bulk substrates.
2. All Phase II, spawning, spawn running and cropping rooms must be airtight. Physically excluding insects from these areas is the most positive control one can exercise. Even the smallest crack can serve as an entrance to the growing room. The spawn running rooms should be the most secure with access to these areas restricted. All doors should be weather-stripped and tight fitting. Positive pressure and air locks also help.
3. All tools and implements should be cleaned and disinfected before use on a new crop. A commonly used disinfectant is a 2% chlorine solution.
4. Breeding areas must be prevented by removing from the premises all excess or spent substrates, used grains, mushroom trimmings and other related by-products.
5. The growing room and all containers should be washed and disinfected between crops. Wood in particular harbors contaminants, including virus infected mushroom mycelium. Treatment of wood with cuprinol or copper sulfate is common. Petroleum based products should be avoided.
6. Fresh air intakes and exhaust vents must be screened with fine mosquito netting. Be sure there are no cracks around the filters and fan housing.
7. The room should be equipped with an insect monitor. The use of a monitor alerts the grower to fly emergence from within the growing room or to fly entry from the outside. The monitor can be as simple as a 12" x 12" plywood board to which a small black light (long wave UV) is centrally mounted. On either side of the light sticky paper is attached. There are also small pest lights commercially available. (See Resource section in the Appendix).

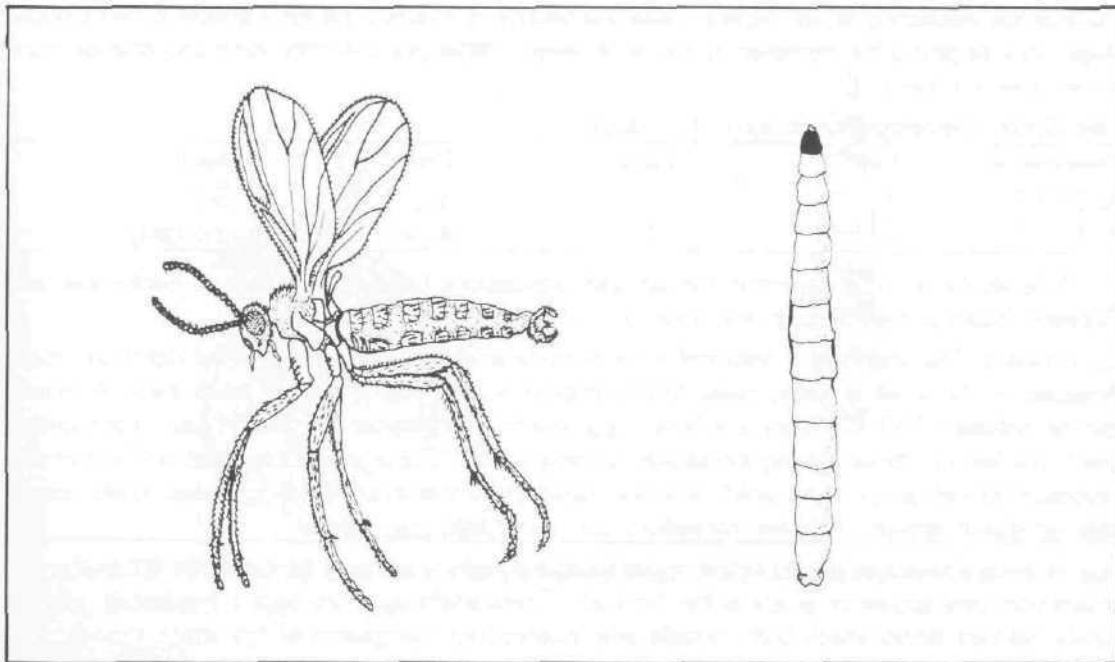

**Figure 231** Sciariid adult and its larva. (Adapted from P.R. VanderMeer; Penn. St. Univ. Coop. Ext. Ser.)

**Order:** *Diptera*

**Family:** *Lycoriidae* (Fungus Gnats)

**Genus/Species:** *Lycoriella solani*, *Lycoriella mali*, *Lycoriella auripila*

**Common Names:** Sciariid Fly, Big Fly

**Natural Habitat:** Predominantly saprophytes, living on wild mushrooms, rotting wood, leaf mold and manure piles. Maturing mushrooms are frequently infested with sciariid larvae, the so-called "worms" that commonly ruin choice wild edibles.

### PHYSICAL CHARACTERISTICS

**Mature Stage:** Sciariids are small gnat-like flies characterized by two long segmented antennae, large compound eyes, a black head and thorax and a yellow segmented abdomen. Females are about 3 mm. long and can be distinguished by the swollen abdomen which ends in an ovipositor. Males are about 2 mm. long and have a narrow abdomen ending in a distinct clasper.

**Larval Stage:** Larvae measure 6-12 mm. long with twelve abdominal sections and a distinct black shiny head. The long creamy white body has a semi-transparent cuticle with a visibly darkened alimentary canal. Larvae go through four development stages, or instars, before pupating.

**Pupal Stage:** Fully mature larvae spend two to three days spinning a cocoon of fine silky threads and compost fragments. These threads are sometimes detected as slime trails left behind in the sub-

strate as the wandering larvae pupate. **Once** the cocoon is finished, the larva contracts into a pupal stage, thus beginning the transition to the adult stage. Pupae are **2-4** mm. long and change from white to almost black.

Life Cycle: Developmental period in days

Temperature	Egg	Larva	Pupa	Adult
At 75 ° F.	2	16	3	5-7
At 61 ° F.	7	23	8	(no data)

Sciarids thrive in the summer and fall with populations building to a peak in September and October. Sciarids then die with the onset of cold outside temperatures.

**Comments:** The sciarid fly is responsible for considerable damage to commercial *Agaricus* crops. Attracted by the smell of newly pasteurized compost, sciarids home in from miles away. A female can lay between 150-170 eggs at a time. Eggs laid in the compost just after Phase II composting hatch quickly into larvae during the spawn running period. **These** larvae then feed on the running mycelium as well as compost, which is broken down into a foul smelling, soggy mass, Totally unsuitable for spawn growth. Massive infestations can cause total crop failure.

At lower infestation levels, larvae migrate into The casing layer and then emerge just as the first mushroom pins appear or as late as the first flush. These adults lay more eggs in the casing, and the newly hatched larvae attack both mycelia and mushrooms. Symptoms of this attack include:

1. Dead pinheads.
2. Pins or mushrooms that are loosely connected to the casing due to severed mycelial connections.
3. Brown or black spots on pinheads or on the stems of mushrooms.
4. "Salt shaker pins" perforated by larval tunnels.
5. Browning of the stem where cut.

Secondary damage to mushroom crops by sciarid flies comes from their role as carriers of mites and diseases, including the pathogens *Verticillium* and *Trichoderma*. A single sciarid fly can carry up to **20** mites!

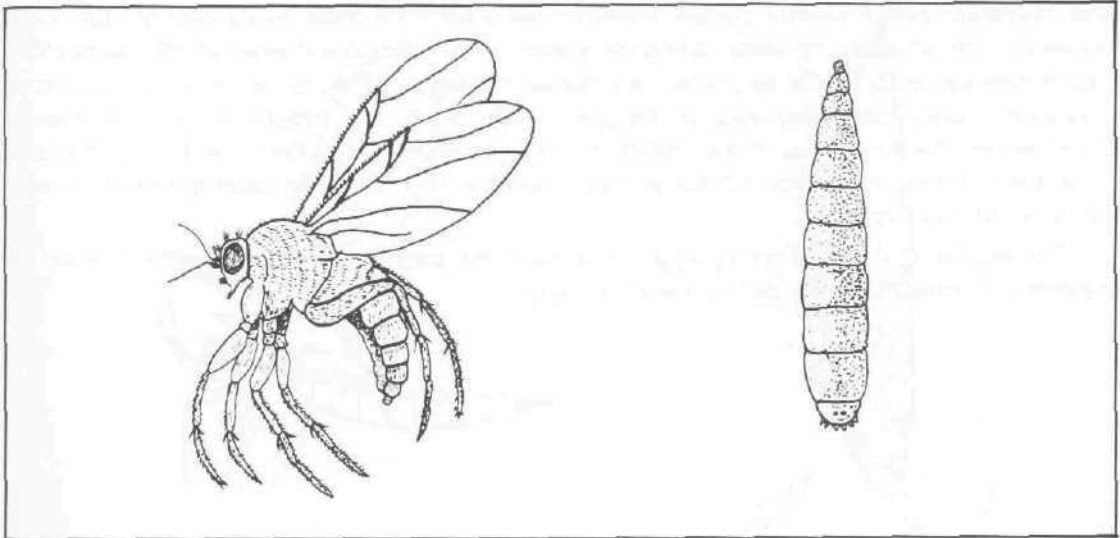

**Figure 232** Phorid fly and its larva. (Adapted from P.R. VanderMeer; Penn. St. Univ. Coop. Ext. Ser.)

**Order:** *Diptera*

**Family:** *Phoridae*

**Genus/Species:** *Megaselia nigra*, *Megaselia halterata*

**Common Names:** Phorid Fly, Dung Fly

**Natural Habitat:** Commonly inhabiting manure piles and rank, decaying vegetation; feeding on wild fungi and their mycelia. Phorid larvae are frequently seen tunneling through wild mushrooms.

**PHYSICAL CHARACTERISTICS:**

**Mature Stage:** Distinguishing features are a humped back, a rapid jerky run, a rounded third antennal segment and a yellowish to reddish brown back. Adults measure 2-5 mm. long. Females live 16 days and males live 10 days.

**Larval Stage:** Larvae are 6-10 mm. long, white and semi-transparent. The head is characterized by a pair of "mouth hooks" with seven teeth. The segmented body tapers from the head to the posterior end. Larvae pass through three instars.

**Pupal Stage:** Pupae are white at first then becoming pale yellow to brown. They can be distinguished by a pair of curved black respiratory horns.

**Life Cycle: Developmental period in days**

Temperature	Eggs	Larvae	Pupa
75 °F.	2	5	8
61 °F.	4	14	28

**Comments:** Phorids can do extensive damage to the mushroom crop and are considered the prin-

cipal mushroom pest in western Europe. Mated female phorids are drawn by the odor of mushroom mycelium. This attraction increases during the spawn running period and peaks at full colonization. Each female can lay up to 50 eggs which are placed in close proximity to the mycelium. In mature mushroom crops, females lay eggs on the gills, in the casing, and adjacent to young pinheads. Once hatched, the larvae feed on the mycelium, then tunnel into the mushrooms through the base of the stem. Arising from these tunnels are secondary bacterial infections causing further damage and brownish discolorations.

The fact that females will not lay eggs in total darkness gives the grower an effective method for preventing Phorid infestation during spawn running.

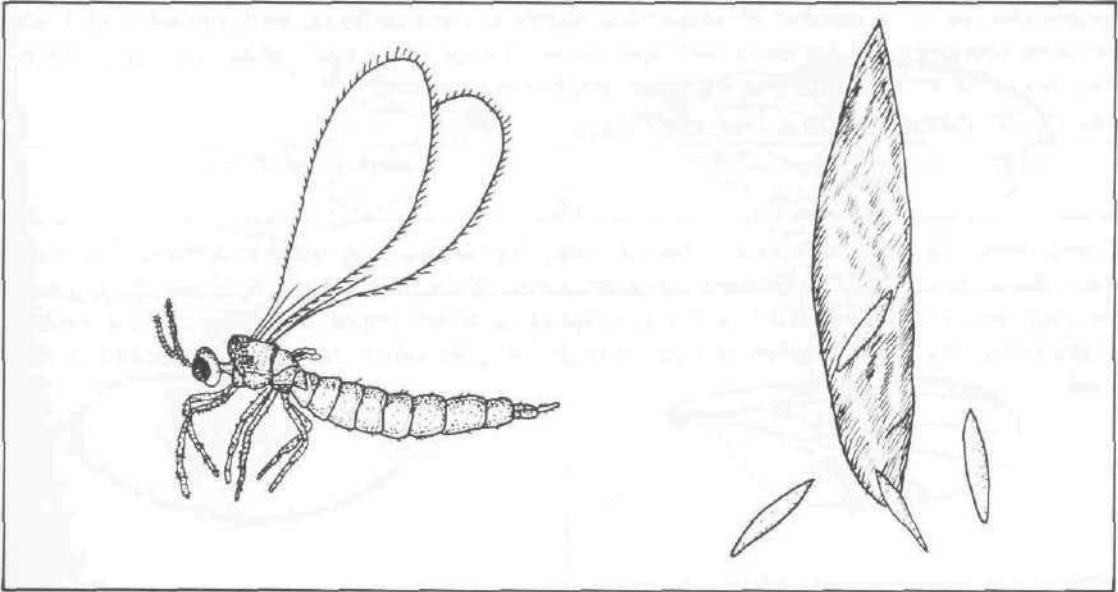

Figure 233 Cecid fly and its mother larva. (Adapted from P.R. VanderMeer; Penn. St. Univ. Coop. Ext. Ser.)

Order: *Diptera*

Family: *Cecidomyiidae*

Genus/Species: *Heteropeza pigmaea*, *Mycophila speyeri*.

Common Names: Cecids, Gall Midges

**Natural Habitat:** Commonly inhabiting decaying wood, rotting vegetation and manure piles or wherever fungal mycelium occurs.

#### PHYSICAL CHARACTERISTICS:

**Mature Stage:** Adult cecids measure less than 1 mm. long making them almost invisible to the naked eye. *H. pigmaea* are orange with a long segmented abdomen and segmented antennae. Wing venation or structure is noticeably absent except close to the thorax.

**Larval Stage:** Newly born larvae are 1 mm. long and 2-3 mm. when mature. *H. pigmaea* are white to cream; *M. speyeri* are bright orange. Larval movement is facilitated by free water, whereas in dry conditions this movement is by flexion, jumping as far as 2 cm. Larvae are photokinetic (moving to light) and can reproduce through paedogenesis, a process whereby mother larvae give birth to daughter larvae. Under optimal conditions mother larvae can produce 14-20 daughter larvae in six days. Thus, in a short period of time a population explosion can occur.

**Pupal Stage:** *H. pygmaea* larvae molt to a rigid "hemi-pupa" within which new daughter larva evolve. Conditions favorable to larval growth lead to a "resting mother larvae" stage which can

remain alive up to 18 months. *M. speyeri* has neither of these particular attributes although it also performs paedogenesis. Larvae of both species can change to "imago" larvae, form only one instar, then molt to free pupae, emerging as adults five days later.

**Life Cycle: Developmental Period in Days**

Egg	Mother Larva		Daughter Larva
2	5-6	(2)	5-6

**Comments:** Cecid larvae pierce or tear growing hyphae, sucking out the contents. The main loss suffered by commercial growers is contamination of the mushrooms by larvae. *H. pygmaea* can also carry a bacterium which produces longitudinal brown stripes on the stem. In the infected mushrooms, tiny black droplets of fluid form on the gills, which then become spotted or turn black.



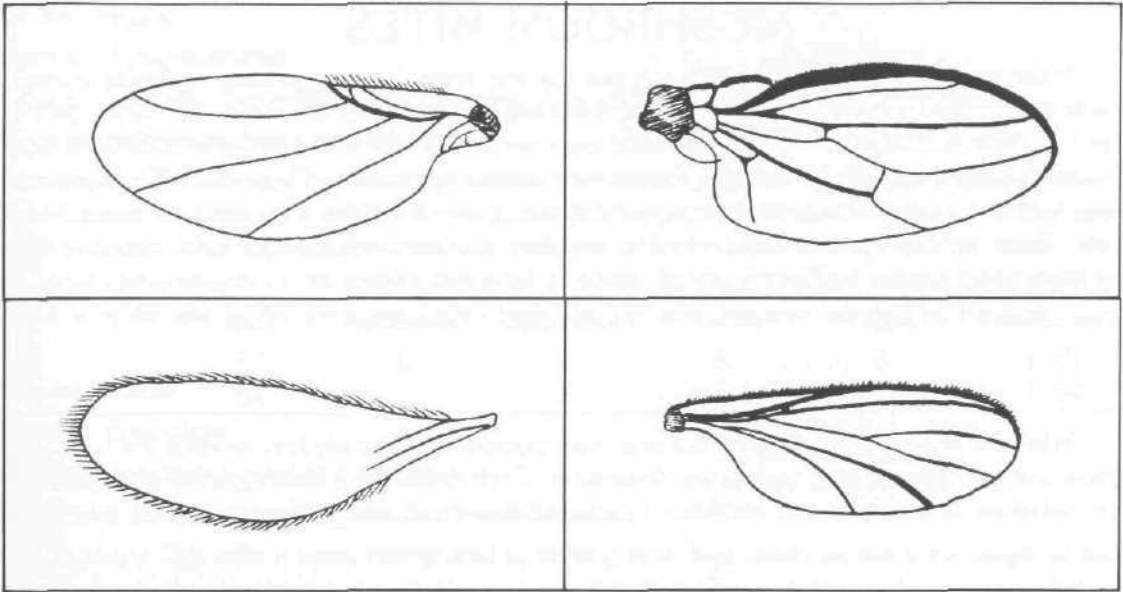

**Figure 234** Wing venation of mushroom flies: clockwise from top right, *Leptocera*, *Sciariid*, *Cecid* and *Phorid*.

**Order:** *Diptera*

**Family:** *Sphaeroceridae (Borboridae)*

**Genus/Species:** *Leptocera heteroneura*

**Natural Habitat:** Associated with manure, compost piles and decaying organic matter.

**PHYSICAL CHARACTERISTICS:**

**Mature Stage:** *Leptocera* has large red compound eyes and with a yellow and black striped abdomen. *Leptocera* flies are very similar to phorid flies but are smaller and have a distinctive wing venation. They somewhat resemble the common fruit fly.

**Larval Stage:** Larvae have a blunt posterior end tapering to a slender head which is equipped with mouth hooks. *Leptocera* larvae are very similar to house fly maggots in appearance.

**Pupal Stage:** Pupae are golden brown and barrel shaped.

**Life Cycle: Developmental Period in Days**

Egg	Larva	Pupa
3	14-28	10-14

**Comments:** The *Leptocera* fly acts as a vector for disease organisms and is frequently associated with bacterial infections. It is a known carrier of mites.

## MUSHROOM MITES

Mites are very small spider-like insects that live and breed in decomposing vegetable matter, feeding on molds present therein. Optimum breeding environments are moist and warm, giving rise to a rapid succession of generations and exponential growth. Under adverse conditions certain mites have the ability to change into an intermediate stage called a "hypopus". The hypopae have flattened bodies, short stubby legs and a sucker plate with which they attach to moving objects. These attributes facilitate dispersal. An excellent survival mechanism, it is the hypopae that are commonly carried by flies. A typical life cycle for mites in days is:

Temperature	Eggs	Larvae	Protonymph	Tritonymph	Total
75°F.	6	2	2	3	13
60°F.	11	8	6	11	36

Mites are known to eat mushrooms and their mycelia. Additionally they devalue the crop and crawl onto pickers, causing temporary discomfort. Their presence is an indication of unsatisfactory substrate preparation and insufficient pasteurization Times and/or temperatures.

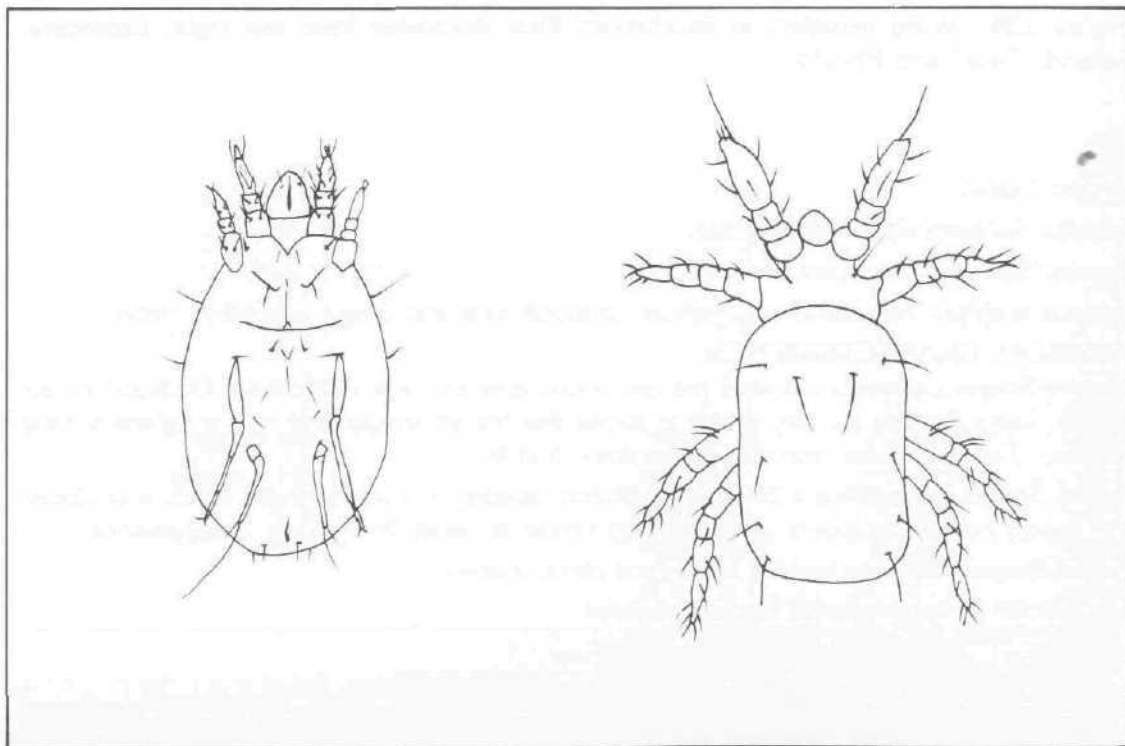

Figure 235 Straw mites.

**Order:** *Arcana*

**Family:** *Tyroglyphidae*

**Genus/Species:** *Tyrophagus putrescentiae*, *Caloglyphus mycophagus*

**Common Names:** Straw or Hay Mites

**Discussion:** Straw mites have soft translucent pinkish or yellowish bodies punctuated by long flexible hairs. One female is capable of producing 500 eggs in a lifetime. Commonly found in hay or straw piles, these saprophytic mites are endemic to foul compost. They feed on molds and bacterial contaminants of the mushroom crop and also eat mycelium and mushrooms, making small irregular pits in the stem and cap. These pits can later become infected by bacteria.

**Order:** *Arcana*

**Family:** *Eupodidae*

**Genus/Species:** *Linopodes antennaepes*

**Common Name:** Long Legged Mushroom Mite.

**Discussion:** This mite is easily recognized by its long front legs which are twice the length of the light, yellowish brown body. It is not believed to be directly injurious to the mushroom crop and in fact is a predator on other mite species.

**Order:** *Arcana*

**Family:** *Tarsonemidae*

**Genus/Species:** *Tarsonemus myceliophagus*

**Common Name:** The Mushroom Loving Mite.

**Discussion:** *Tarsonemus* mites are very small, 180-190 microns long, with pale brown, shining, oval bodies. They occasionally swarm in masses on mushroom caps but otherwise are rarely seen except by microscopic examination. Females produce an average of 22 eggs in a lifetime of 2-8 weeks. These mites cause a bright reddish-brown discoloration at the base of the mushroom stem and may cut the stem's mycelial connections. Known to survive normal compost pasteurization temperatures, they can carry a virus disease to *Agaricus brunnescens*.

**Order:** *Arcana*

**Family:** *Pyemotidae*

**Genus/Species:** *Pygmephorus* sp.

**Common Names:** Red Pepper Mites; Pygmy Mites.

**Discussion:** Pepper mites are small (250 microns long) with yellowish brown, wedge-shaped bodies, crossed by a central whitish band. Red pepper mites are often seen as a swarming jostling mass, on mushroom caps or the surface of the casing. These mites are commonly associated with *Penicillium* and *Trichoderma* molds, upon which they feed.

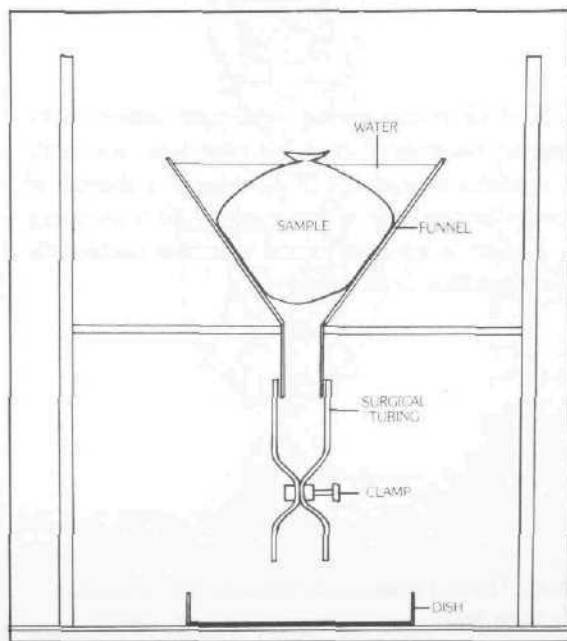
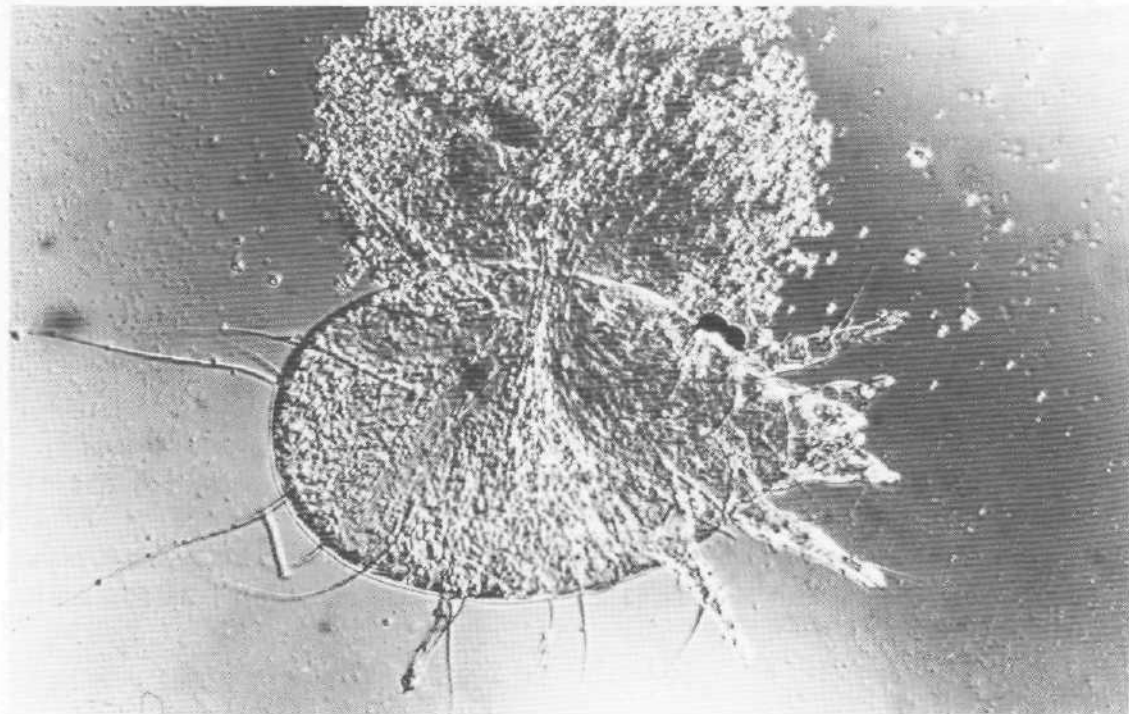

Figure 236 Light micrograph of Red Pepper Mite. Note that darkened shapes by front leg are *Panaeolus subbalteatus* spores. See also Figure 230.

Figure 237 Nematode testing apparatus. Sample is wrapped in gauze and submerged in a water filled funnel. After twenty-four hours, a small amount of water is drawn off and examined with a magnifying lens or dissecting scope.

## NEMATODES

Nematodes or eelworms are microscopic roundworms which live in soil, decomposing organic matter, fresh or salt water, or on living host plants, fungi, insects and animals. Nematodes can survive up to six weeks without food and are unaffected by freezing. With eight billion nematodes in each acre of soil, they are one of the most numerous creatures on earth.

Water is essential for locomotion and breeding. Swimming in an eel-like fashion and because of their minute size, nematodes can live in the thinnest films of water. With sufficient water, nematodes rise to the surface of their environment. In moist casing, large numbers of nematodes are visible as a shimmering veneer on the casing surface. This behavior is called "winking" and is caused by the nematodes standing on their tails and waving their bodies in the air. Considered to be an adaptation for dispersal, the winking nematode adheres by means of a sticky outer skin to whatever they come in contact with, be it a fly, mite, human hand or clothing. This same outer skin protects the nematode from adverse conditions.

If dried slowly, nematodes can change to a "cryptobiotic" or "cyst" state, thereby preserved for years until reactivated by water. In this cyst state, nematodes are also able to persist in high temperatures that would otherwise be lethal.

Parthenogenesis, the ability for females to breed asexually without males, is common among nematodes and leads to very rapid population expansion. By this means, a single nematode can breed millions of descendants within a few weeks. Nematodes can also reproduce sexually, but not as rapidly.

Nematodes present in mushroom culture can be classed into two basic types according to their feeding habits: **saprophagous** and **mycophagous**.

### Saprophagous Nematodes

**Genus/Species:** *Rhabditis* spp.

Saprophagous eelworms are characterized by a tube-like mouth through which they suck nutrient particles suspended in water. These nutrients are comprised of organic matter and its accompanying microorganisms, particularly bacteria. Because bacteria occur in large numbers in both mushroom compost and casing soil, these materials provide excellent breeding grounds for saprophagous eelworms.

In bulk substrates such as compost or plain straw, nematodes can be found in great numbers. The high temperatures of Phase I conditioning would normally destroy them if it were not for the fact they migrate to the cooler outer shell of the compost pile. Phase II can eliminate nematodes but only if the entire compost is subjected to pasteurization temperatures. In a properly prepared and thoroughly pasteurized substrate, the mushroom mycelium consumes all free water and then feeds on the bacterial population. This creates a "bacteriostatic environment", which effectively limits nematode growth capabilities. In an uneven substrate with overly wet and dry areas, however, the nematode's ability to breed increases. Wet areas are particularly suitable for

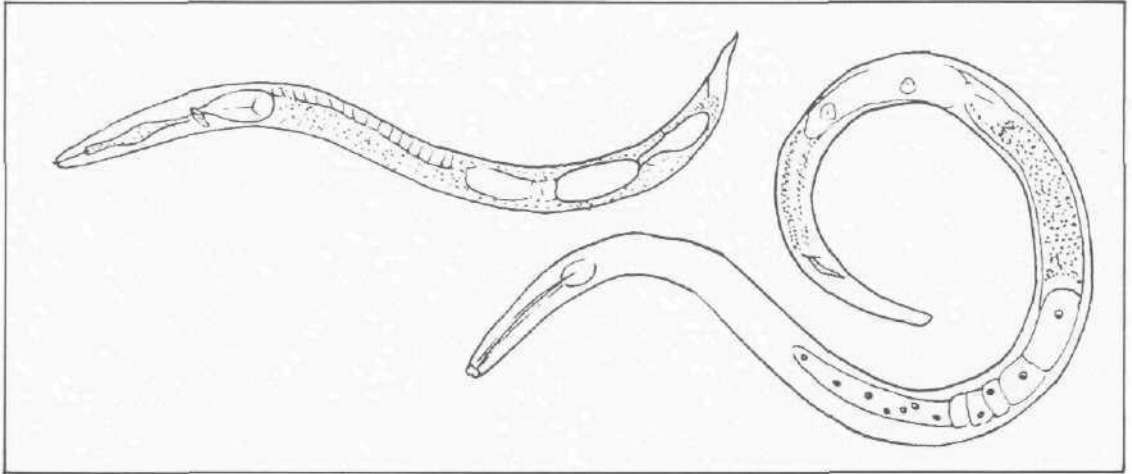

**Figure 238** Mycophagous eelworm (top) and Saprophagous eelworm. Note stylet in mouth tube of former.

eelworms to breed and feed. And, as their population increases, the build-up of waste material from metabolic excretions soon fouls the substrate, rendering it unsuitable for mycelial growth. These excretions result in similar damage to infested casing soils.

Although saprophagous eelworms are not primary pathogens, their presence indicates improper hygiene or imbalanced growing conditions. For this reason, control measures focus on prevention rather than treatment. In fact, there are no practical means to treat infested areas that would not likewise harm the mushroom mycelium.

## Mycophagous Nematodes

**Genus/Species:** *Ditylenchus myceliophagus*; *Aphelenchiodes composticola*

Mycophagous eelworms feed directly on mushrooms. They are characterized by a mouth stylet or needle with which these eelworms puncture hyphae, inject digestive juices and then suck out the cellular contents. The damaged cell, drained of its cytoplasm, soon dies. Feeding continually and moving from cell to cell, mycophagous eelworms can soon destroy whole mycelial networks. In infected substrates, the fine mycelial growth disappears, leaving only the coarse strands which give the appearance of stringy growth. Eventually the substrate becomes soggy and foul smelling, a condition further promoted by the build-up of anaerobic bacteria. Often the nematode trapping fungi, *Arthrobotrys* spp. develop in association with them. It is visible as a fine grayish mold-like growth. Although the presence of this mold is a useful indicator of nematode infestation, it is not a true control for these organisms.

Mycophages differ from saprophages in their slower non-parthogenetic reproduction and their lack of the "winking" behavior mentioned earlier. Both Mycophagus species can reproduce 30-100 fold in about two weeks at 70-75°F.

## CHAPTER XV MUSHROOM GENETICS

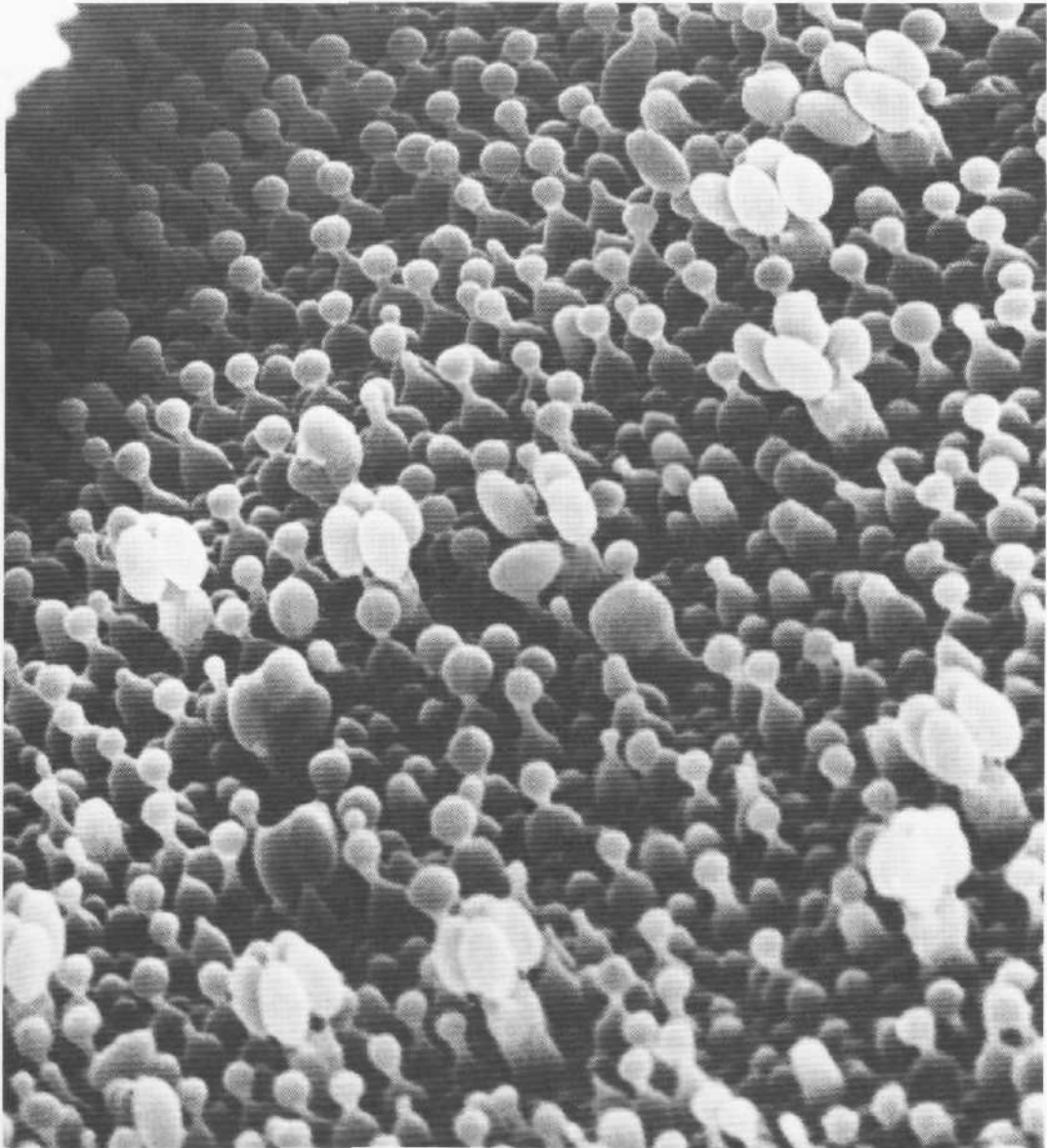

Figure 239 Gill face of *Psilocybe cyanescens* populated with fertile spore-bearing basidia and sterile cells called pleurocystidia.

## INTRODUCTION

This chapter discusses what genes are and what they do. It addresses the relationship between an individual's set of genes and the characteristics of that individual. The implications of genetics for the grower or breeder of mushroom strains are examined and an improved, easy technique for generating cultures from spore prints will be presented.

### What Are Genes?

Genes contain specific sequences of nucleotides, the nitrogen-based building blocks of the DNA molecule. These sequences specify the order of nucleotides in messenger RNA molecules, which in turn determine the sequence of the amino acids in a protein chain. For the purposes of this discussion, genes may be regarded as indivisible units, although in fact, they can on rare occasions be split or altered. A mutation is the permanent alteration of a gene caused by some outside force (chemicals, radiation, mistakes by the DNA copying mechanism of the cell, etc.). In discussions of genetics, a gene is often referred to as a genetic **locus**, emphasizing the fact that genes are regions of a DNA molecule. Within a population of a species, there are many differing copies of each gene. Each copy is referred to as an allele of that gene.

### What Do Genes Do?

Genes are the blueprints of life. They specify the structure of RNA and protein molecules; these molecules create all the other compounds and structures which make up a living organism. An individual organism is an emergent property of its genes in that not only is it the result of gene products, but also the interactions of gene products. The expression and interaction of genes, that is the characteristics of an individual, are known collectively as the **phenotype** of that individual, whereas the sets of genes which produce the phenotype is known as the **genotype**.

### The Advantage of Multiple Copies of Genes

Many genes are present in the genotype in several copies, and these copies are often different from one another. This is because the protein specified by any one gene copy has unique physical and chemical properties of its own. It functions most efficiently at a certain temperature, pH and salt concentration. If an important protein is represented in several different gene versions, a broad band rather than a narrow range of temperatures and chemical conditions will be optimal.

### Chromosomes

Chromosomes are collections of genes. They are long DNA molecules, each of which contain several thousand genes. For this discussion, the genes are best visualized as beads on a string, so that the string can be cut at any point between the beads, and can be rejoined at the place of the cut or to any cut "string portion" or the chromosome.

Chromosomes are very small. With special stains and high powered microscopes, the larger ones can be seen. Unfortunately, the chromosomes of fungi are extremely small, and the number of chromosomes, something characteristic of each species, has never been determined for most fungi.



There is a complete set of chromosomes in every cell of every organism. This means that every time a cell divides, a complete copy must be made of every chromosome, and hence of every gene in the organism's genome. The cellular copying process is very nearly perfect, with errors being made at about the rate of one per million genes. That is, to find a random mutation of a particular gene, you would have to look at a million cells. Factors which produce mutations will, of course, increase this rate. These copy errors are the source of background mutations, which are always appearing in every organism.

## Mitosis

Mitosis is the normal process of chromosome duplication which takes place every time that a cell divides. In it, all the chromosomes are duplicated, and in the early stages of the process, the copies stick together. All of the duplicated chromosomes line up in the middle of the cell, and one of the two copies of each is pulled to either end of the cell, resulting in two complete sets of chromosomes.

## Meiosis

Meiosis is the unique series of events which takes place when a cell is involved in sexual reproduction. In meiosis, the chromosomes are copied just as in mitosis, but the genes are shuffled in a process called **recombination**. Sexually reproducing organisms have two sets of chromosomes, one from each parent. In meiosis, these two sets line up side by side, and reciprocal exchanges of sections of chromosomes take place. That is, a section of the maternal copy of a chromosome is transferred to the paternal copy, and a section of the paternal copy is simultaneously transferred to the maternal one. This happens to all of the chromosomes, usually once per chromosome, but sometimes more than once.

After these reciprocal exchanges take place, two successive cell divisions occur, resulting in four cells, each with ONE copy of each chromosome. None of these cells are identical to any of the others. They each have unique sets of genes. These cells are known as **gametes**, and are basidiospores in a mushroom, ascospores in a cup fungus or a yeast and sperm or egg cells in an animal.

It is this act of recombination of genes within the genome and the combination of genomes from two parents which is the genius of sexual reproduction. By this mechanism, variety is constantly introduced into the population of a species. A bacterium, which can reproduce very rapidly by mitosis, can generate vast numbers of bacteria in a very short time, *but all of the offspring are identical*. The importance of this difference cannot be overstated. If conditions fall below optimal or into the lethal range for the parent bacterium, all of the progeny soon die or are equally affected (unless, of course, there has been a favorable random mutation). Chance favorable mutations are, in fact, the major means of evolution available to bacteria.

Sexual reproduction, on the other hand, constantly spins off variation. Some of the progeny are standard and do not survive, or do poorly, most are average and some are clearly superior, flourishing and leaving behind a greater number of offspring than the other groups. In this way, the population is enriched in gene combinations which are better adapted to the environment.

## REPRODUCTIVE STRATEGIES

The two aforementioned modes of reproduction lead to three primary reproductive strategies. These are the primary use of asexual reproduction, the primary use of sexual reproduction and the sequential or seasonal use of both methods of reproduction.

1. Asexual (mitotic) reproduction allows an organism to produce large numbers of offspring in a very short period of time. This makes possible the rapid exploitation of any ecological niche which becomes available. This strategy is used by bacteria, yeasts, many molds (Fungi Imperfecti) and a surprising number of plants.

2. Sexual reproduction is not as rapid, since meiosis, gamete production and fusion and zygote growth are relatively slow processes. The progeny, however, have built-in variation and are capable of exploiting a wider assortment of niches than the parents. This strategy is used by larger organisms which tend to live for a longer time than those which are primarily asexual. Examples of organisms using this strategy are polypores, most plants and all large animals.

3. Combining sexual and asexual reproductions in different portions of the life cycle results in a highly effective strategy. This method is utilized by most lower plants and most fungi. In this strategy, when a suitable niche is found, asexual reproduction allows it to be rapidly filled and exploited. When that niche has been populated and nutrients become scarce, sexual reproduction is triggered. As well as releasing a number of varied progeny to the environment, sexually produced spores are usually more resistant to the harsh environmental conditions than mitotically produced spores. Often they are specifically adapted to lasting through winter or through a period of dryness, conditions not conducive to the growth of fungi.

### Asexual Reproduction in the Fungi

Asexual reproduction in the fungi takes many forms, including buds, conidia, sporangiospores and fragmentation products.

Yeasts reproduce by budding, which is the constant growth of new cells from the surface of a mother cell. The new cells literally "blow out" of the mother cell wall like a balloon.

Conidia are mitotic spores which are continuously produced within or upon special structures called conidiogenous cells. Examples of conidial fungi are represented by *Penicillium* and *Aspergillus* molds, the fungi which attack spoiled foodstuffs, the downy and powdery mildew which attack garden plants, and the hundreds of genera which are involved in the breakdown and recycling of debris and litter in nature.

Sporangiospores (spores formed in batches within saclike structures called sporangia) are found in the water molds and the Zygomycetes. *Rhizopus*, which is often seen on breads and strawberries, reproduces in this manner.

A common mode of asexual reproduction is for portions of vegetative mycelium to thicken and form heavy walls and septae. These reinforced hyphal fragments then break apart and are distributed by natural processes. These vegetative propagules are called by many names, including ar-

throspores, chlamydospores, gemmae and others.

## Sexual Reproduction in Mushrooms

While mushrooms reproduce sexually, they have no sexes. All that the term sexual reproduction means is that two sets of genetic information are carried, and that the genes in those sets are shuffled randomly before one set is provided to each gamete. Two gametes must come together and fuse to form the next fertile generation.

In animals and plants, the notion of sexes is realistic, because there are two kinds of gametes, an egg and a sperm. In mushrooms, all the gametes are physically identical; they are the basidiospores. Because of meiosis, however, there are genetic differences between them.

One of the genetic characters sorted out during meiosis is the **mating type**. The mating type is a character which prevents a spore or monokaryotic hypha carrying a particular allele from fusing sexually with any spore or hypha carrying the same allele, no matter how different the genomes are at all other loci. It takes the presence of different alleles at the mating type locus for sexual reproduction to occur. In any one species, there may be any number of alleles within the population. In general, any one of them is compatible with all of the others, the only prohibition being against fusion with the identical mating type.

If a species of mushroom has only one locus controlling mating type, with varying numbers of alleles for that locus, that species has what is known as an **unifactorial, heterothallic** mating system. In such a system, the only physiological requirement for mating to take place is that two differing alleles of the mating type locus be present. Since two alleles must be present in a sexually mature mushroom, and each spore only gets one, any random spore is compatible with half of its siblings. Since there are a large number of alleles for the mating type locus in the population at large, any random spore has a higher probability of being compatible with a spore of another strain. Thus this system increases the percentage of outcrossing by members of the species using it.

The majority of mushrooms, however, are **heterothallic and bifactorial**, a system known as **tetrapolar**. In this system, there are two separate and distinct mating type loci, each of which must have differing alleles present to form a dikaryotic colony. This system produces four distinct types of spores on each basidium, and any random spore from a single strain is fertile with only one fourth of its siblings. This is a strong form of incest taboo, and makes it four times as likely that any naturally formed dikaryon will be from non-related spores. Unfortunately, the two types of spores which are not totally identical or non-identical can form dikaryotic colonies which look like fertile ones. These products of illegitimate matings, though, are incapable of making fruitbodies or basidiospores.

There are strains and species in which the mating type system has broken down. These are known as **homothallic** fungi, and they are fully capable of mating with themselves. In fact, a single spore of a homothallic fungus is usually capable of making a fertile dikaryotic colony. A fair number of spores, however, due to the effects of recombination, will be incapable of forming fertile colonies unless they mate with another strain. This is a system often found in fungi which live in marginal habitats; usually there is a time lag before a monokaryotic colony dikaryotizes itself.

There are two types of homothallism in mushrooms: primary and **secondary**. Primary homothallism is the case described above, where the majority of spores, while initially forming monokaryotic colonies, will eventually become dikaryotic and fruit normally. Secondary homothallism is the case where each spore receives one nucleus of each mating type, generating a dikaryotic colony from the moment of spore germination. *Agaricus brunnescens* is the best known example of this type of fungus, while another commonly cultivated mushroom, *Volvariella volvacea*, has a primary homothallic mating system.

## IMPLICATIONS FOR CULTURE WORK

The single most important implication of the genetics that has been described thus far is the occurrence of illegitimate matings. In a tetrapolar fungus, only one fourth of the spores from any one mushroom are fully compatible with any random spore from that same strain. This mechanism exists to encourage outcrossing. When a cultivator is trying to produce a strain from a spore print, establishing a fruiting strain can be frustrating. This is because monokaryotic hyphae with common A factors or with common B factors can fuse and form dikaryons, and these dikaryons can even make convincing looking clamp connections. (See Figs. 10 and 182). These colonies, however, are incapable of fruiting. It becomes obvious at this point that two thirds of the random dikaryons formed will be of the illegitimate type. This implies that a large number of dikaryotic cultures must be isolated and tested for fruiting ability. Another, but less precise way around this problem is to inoculate with a large number of spores and take a tissue culture of the first mushroom that appears in the culture. This procedure is the one usually listed in books on mushroom cultivation because it is simple, but the strains produced in this manner still must be tested thoroughly.

The phenomenon of **sectoring** is the production of wedge shaped areas of differing physical or growth characteristics by a colony of mycelium. There are two types of sectoring, one found in young cultures, and one in old ones.

In young multispore cultures, several different strains are all growing together at the same time. Some are the products of legitimate matings, some of illegitimate ones. These strains all have differing characteristics. Some of these strains grow faster than others, some are rhizomorphic and some are fluffy in appearance, some fruit well, some poorly. Some produce clumps of many tiny mushrooms, some produce a few large ones. They each have a unique set of preferred culture conditions.

Fortunately, the different strains formed from multispore germinations tend to sort themselves out. As the colony grows, strains segregate into sectors of different appearances and growth rates. The repeated separation and propagation of individual sectors, until a colony is obtained which no longer produces new ones is one way of isolating a pure strain. Several strains may be isolated from the same original petri plate in this way.

As pure cultures grow old and become senescent, they produce ever greater quantities of sectors due to the accumulation of random mutations. Repeated subculturing of the culture gives accumulated mutations a chance to express themselves. A strain which has reached this condition is no longer pure, and should not be used for cultivation.

---

## Culture Trials

When a number of strains have been generated from a sporeprint, they are different because of recombination in the basidium. Some of the strains MAY be identical to the parent strain, but that **must** demonstrated by some testing procedure. As in any screening operation, the more strains used, the better the chance of a good result. In fact, professional mushroom breeders often do trials with thousands of strains at a time. This kind of work, however, takes large and expensive facilities, and is unnecessary if the purpose is simply to find a strain which fruits well under a certain set of conditions. A strain which fruits well in test batches under uniform conditions has a high likelihood of doing well in larges batches when The same conditions of temperature, humidity and aeration are maintained. How many strains need to be tested? If the mushroom being worked with is tetrapolar, only one third of the dikaryotic colonies picked out will be capable of fruiting at all. In order to make trials of ten fruiting strains, begin with at least thirty dikaryotic strains.

Many mushrooms, especially the wood-rotters, fruit on enriched agar media in a petri plate if given proper temperatures and some light. If the mushroom being tested is one of These, the selection of fruiting strains is simple. A mushroom requiring a special substrate or additive to fruit should be provided with the smallest amount allowable. For example, *Agaricus brunnescens* can be fruited on 50 grams of sterilized grain in a pint jar, if it is cased with soil containing certain bacteria. The

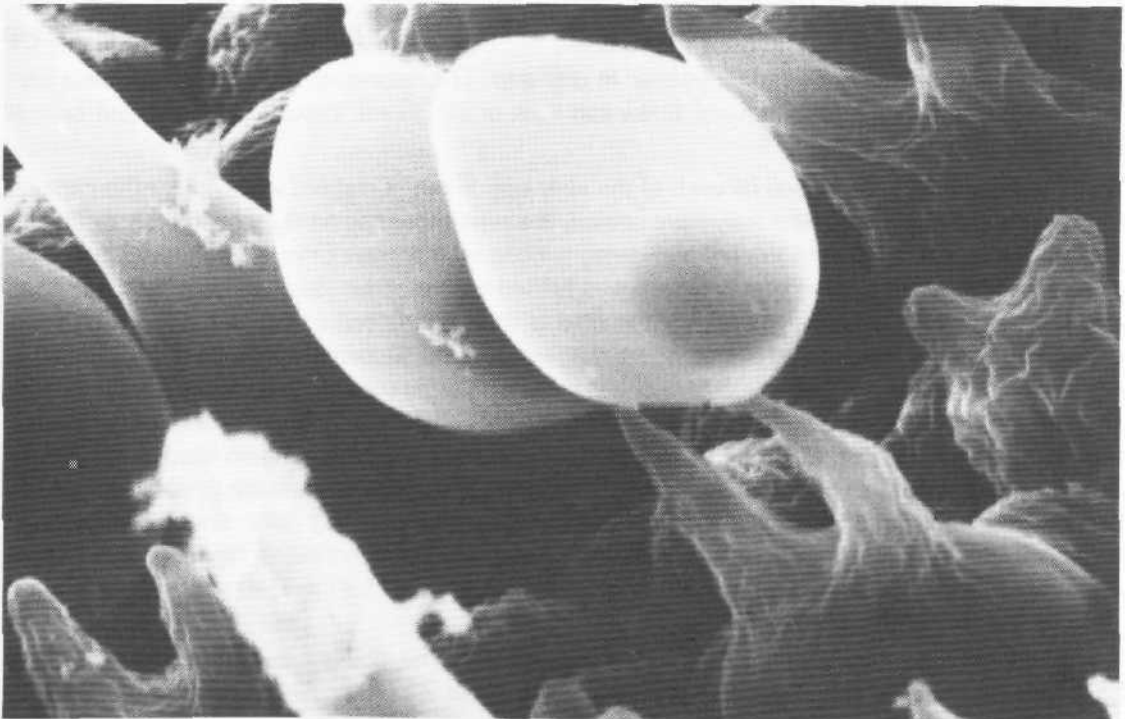

Figure 240 Two spored basidium of a Copelandian *Panaeolus*.

smallest possible amount of substrate allows the rapid determination of fruiting strains.

Once ten to fifteen fruiting strains are in hand, they should be tested in a small scale version of the ultimate culture method. This step allows the strain best adapted to culture conditions to be selected. All strains should be tested at least in duplicates; five replicates per strain are preferable.

If the ultimate cultivation method involves beds of compost, the tests can be made with small boxes filled with compost, but the boxes should be filled to the same depth as the beds will be in the full scale project. If the fungus is fruited in jars (ex. *Flammulina velutipes*), a few jars can be inoculated with each strain. Good records must be kept for comparing the fruiting potential of each strain.

In small scale trials such as these, often several strains look good. In this case, the only way to find the best one is to make full scale trials, with one third or one fourth of the jars or beds inoculated with each of the strains being tested. Once again, good record keeping practices should soon show the differences between the most and least productive strains.

If the mushroom under consideration for cultivation takes a long time to establish its fruiting cycle (ex. *Lentinus edodes*), it is best to simply purchase a culture from a spawn lab or to take tissue cultures from commercially grown mushrooms.

## Spore Dilution Technique

A simple technique can be used to physically separate spores so that individual dikaryotic (or even monokaryotic) cultures can be isolated in one step. The necessary equipment includes a bacterial (small) inoculating loop, several screw-cap vials of 20-30 ml, capacity, a flame and several sterile pipettes or small syringes.

To utilize this method, first fill each of the vials with 9 ml. of distilled water, place the caps on loosely and sterilize them. After they have cooled, the caps should be firmly screwed down. The inoculation loop is then flamed, cooled and gently rubbed on the spore print, being careful not to get a large mass of spores. The loop is dipped and twirled in one of the vials, which is then recapped and shaken vigorously. One milliliter of the fluid is then transferred to another vial, which is recapped and shaken, generating a dilute spore suspension. This suspension may be further diluted in the same manner. In this way, the cultivator has generated three suspensions of spores, one of high spore density, one 1/10th as concentrated and one with 1/100th or 1% of the original concentration. Now spread 1/10th of a milliliter of each suspension on a separate media filled petri plate (or better yet, use several plates for each dilution). The original strength suspension in all likelihood will produce a dense lawn of cultures, which will be difficult to separate. This is the same condition as is produced with normal spore spreading methods. The less dense suspensions, however, should produce many fewer colonies, usually in the range of 20-50 per plate for the 1:10 dilution and 2-5 per plate for the 1:100 dilution.

Look carefully at the plates having only a few colonies. The slower growing monokaryons can be discerned from the faster growing dikaryons. Pick about 25 of the dikaryons to test for fruiting ability and reaction to culture conditions.

If desired, the monokaryotic cultures can be picked out for a breeding program. This is espe-

---

daily valuable if there are spores from several strains available. When spores are simply spread onto a plate, they adhere to one another, so attempts to simply streak spores of two strains on a plate usually do not yield hybrids.

*(The authors gratefully acknowledge Michael McCaw for the contribution of this chapter on genetics).*

## APPENDICES



Plate 1 *Psilocybe cubensis* mycelium.

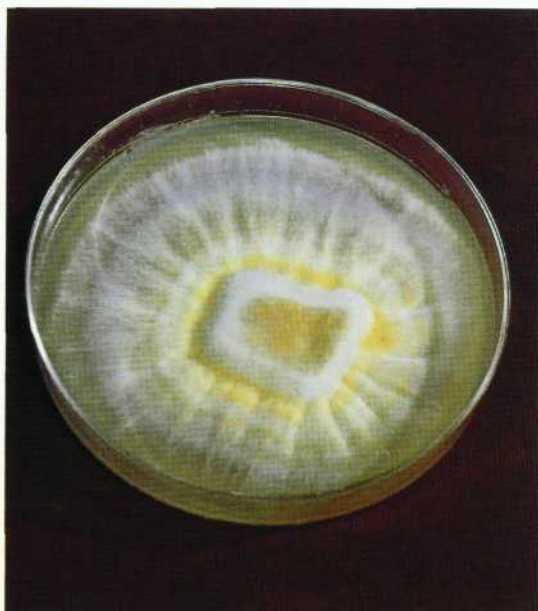

Plate 2 *Psilocybe mexicana* mycelium.



Plate 3 *Lepista nuda* mycelium.



Plate 4 *Psilocybe tampensis* mycelium.





Plate 5 Compost raw materials during pre-composting.



Plate 6 Compost raw materials at ricking.



Plate 7 Compost raw materials at filling.



Plate 8 Compost ready for spawning. Note whitish colonies of *Actinomyces*.



Plate 16 *Psilocybe cyanescens* mycelium running through moist alder sawdust.



Plate 17 *Psilocybe cyanescens* fruiting on alder chips.



Plate 18 *Psilocybe cubensis* fruiting on cased, pasteurized wheat straw.



Plate 19 *Panaeolus cyanescens* fruiting on cased wheat straw.



Plate 20 *Penicillium*, the Blue Green Mold and *Cladosporium*, the Dark Green Mold, growing on malt agar media.



Plate 21 *Aspergillus*, the Green Mold, growing on malt agar media.



Plate 22 *Trichoderma*, the Forest Green Mold, contaminating the casing layer.



Plate 23 *Botrytis*, the Brown Mold, contaminating the casing layer.

# GLOSSARY

## a

- acute** Pointed, sharp.
- adnate** (of the gills) Bluntly attached to the stem.
- adnexed** (of the gills) Attached to the stem in an ascending manner
- agar** A product derived from seaweed and valued for its gelatinizing properties. Commonly used to solidify media in any type of sterile tissue culture.
- Agaricales** The order of mushrooms which includes all mushrooms with true gills.
- amyloid** The characteristic bluish reaction the flesh or the spores of a mushroom exhibits in Melzer's iodine.
- anastomosis** (*pl. anastomoses*) The crosswise fusion of *hyphal* systems to form a network of mycelia.
- angstrom**  $10^{-10}$  microns, 1 ten thousandth of a micron.
- annular** Resembling an annulus, appearing as a ring-like zone.
- annulus** The tissue remnants of the partial *veil* adhering to the stem and forming a membranous collar or ring.
- apex** The top or highest point.
- apiculus** a term (misused) for the *hilar* appendix, the nipple-like projection by which a spore is attached to the *sterigmata* ("arms") of the basidium.
- appendiculate** Hanging with fragments of tissue.
- appressed** Flattened.

**Ascomycetes** Fungi that produce spores in an ascus.

**ascus** A sac-like organ in which eight spores develop and is characteristic of the perfect stage of *ascomycetous* fungi.

**autoclave** A steam pressurized vessel used to *sterilize* media.

## b

**bacillus** (*pl. bacilli*) A general term for any rod-shaped bacteria forming spores in free oxygen environments. (The genus *Bacillus* is more narrowly defined).

**bacterium** (*pl. bacteria*) The simplest group of non-chlorophyll *plant-like* organisms.

**Basidiomycetes** All fungi which bear spores externally upon a club-like cell known as a basidium.

**basidium, basidia** A unique fertile cell, club-like in form, in which meiosis occurs and by which sexual spores are produced.

**basidiocarp** The fruiting body of fungi that reproduce through basidia.

**binucleate** Having two nuclei in one cell.

**border break** The early occurrence of mushrooms along the edge of a substrate container.

## C

**campanulate** Bell shaped.

**carpophore** The fruiting body of higher fungi.

**carpophoroid** Analogous to a fruitbody, although usually a poorly differentiated mass of tissue, not well developed ("aborted") and sterile.

**cartilaginous** Brittle, not pliant.

**casings** A layer of water retentive materials applied to a substrate to encourage and enhance fruitbody production.

**caulocystidia** Sterile cells covering the mushroom stem.

**cellular** Composed of globose to rounded cells, not thread-like.

**cespitose** Growing clustered, appearing to arise from a single base.

**cheilocystidia** Sterile cells on the mushroom gill edge, sometimes called marginal cystidia.

**chlamydospores** A thick walled spore, typically of a secondary type, that arises directly from the mycelium and having the full complement of chromosomes for producing offspring. Chlamydospores are typically ovoid and heat resistant.

**chrysocystidia** A type of cystidia that is highly refractive in once dried tissue revived with a potassium hydroxide (KOH) solution and appearing as a yellowish brown amorphous mass within the cell.

**clamp connection** An elbow-like protuberance which arches over the walls separating cells in mated (dikaryotic) mycelia of some mushroom species.

**compost** A biological matrix of microorganisms combined with straw, manure and other organic substances and designed for mushroom fruitbody production.

**concolorous** Having the same color.

**conditioning** The final conversion of mushroom compost by selected microbial groups.

**conic** Shaped like a cone.

**conidia** A uninucleate exteriorly borne cell formed by constriction of the conidiophore.

**conidiophore** A specialized stalk arising from mycelium upon which conidia are borne.

**conidium** (*pl. conidia*) An asexual spore formed by the constriction of hyphae to chains of cells.

**context** The flesh of a mushroom.

**convex** Regularly rounded.

**Coprinaceae** A family of mushrooms containing the genera *Coprinus*, *Panaeolus* and *Psathyrella*.

**coprophilous** Growing on dung.

**cortinate** A type of veil consisting of fine cobweb-like threads of tissue, extending from the mushroom cap margin to the stem.

**cropping** The time of mushroom formation, development and harvesting.

**cuticle** The surface of cells on the cap that can undergo varying degrees of differentiation.

**cystidia** Microscopic sterile cells adorning the mushroom fruitbody.

## d

**decurrent** The attachment of the gill plates to the stem of mushrooms where the gills are markedly downcurved, partially extending down the stem.

**decurved** Curving in a downwards fashion.

**deciduous** Describing trees that seasonally shed their leaves.

**deliquescing** The process of autodigestion by which the gills and cap of a mushroom melt into a liquid. Most typical of The genus *Coprinus*.

**dikaryophase** The phase in which there are two individual nuclei in each cell of the mushroom plant.

**dikaryotic** The state of cells in the dikaryophase.

**diploid** A genetic condition where each cell has a full set of chromosomes necessary for sexual reproduction (2N).

**disc** The central portion of the mushroom cap.

## C

**eccentric** Off-centered.

**ellipsoid** Shaped like an oblong circle.

**endospores** Spores formed internally.

**entheogenic** A term to describe substances that induce god inspiring feelings or experiences.

**equal** Evenly proportioned.

**eroded** Irregularly broken.

**evanescent** Fragile and soon disappearing.

## f

**fibrillose** Having fibrils.

**fibrils** Fine delicate 'hairs' found on the surface of the cap or stem.

**fibrous** Composed of tough, stringy tissue.

**filamentous** Composed of hyphae or thread-like cells.

**flexuose, flexuous** Bent alternately in opposite directions.

**floccose** Woolly tufts or cottony veil remnants, typically adorning the cap or stem of some mushroom species.

**flush** The collective formation and development of mushrooms within a short time period, often occurring in a rhythmic manner.

**fructification** The act of fruitbody formation.

**fruitbody** What is commonly called the mushroom. The sexual reproductive body of the mushroom plant.

**fugacious** Impermanent, easily torn or destroyed.

**fusoid** Rounded and tapering from the center.

## g

**gelatinous** Having the consistency of jelly.

**genotype** The genetic heritage or constitution of an organism. The genotype produces the phenotype,

**geotropism** Growing oriented towards or in response to gravity.

**glabrescent** Becoming smooth.

**glabrous** Smooth, bald.

**glutinous** Having a highly viscous gelatinous layer, an extreme condition of viscosity.

**Gram (Gram's Stain)** A method for separating bacteria whereby bacteria are stained first with crystal violet (a red dye) and then washed with an iodine solution. Gram positive bacteria (*Bacillus*) retain the dye. Gram negative bacteria (*Pseudomonas* and some *Bacillus*) lose the dye.

**gregarious** Crowding numerously in small groups but not in clusters.

## h

**habitat** The *substrate* in which mushrooms grow.

**heliotropic** Growing or turning towards the sun.

**heteromorphic** Composed of different *cell types*, usually describing the type of mushroom gill edge.

**heterothallic** Having two or more morphologically similar pairs of strains within The same species. The combination of compatible spore types is essential for producing fertile offspring. Typically a spore on a four spored basidium is compatible with *only* one of its counterparts.

**hilar appendix** The *stub-like* protrusion on the spore that connects the spore-producing cell (ex. the basidium) to it.

**hilum** A marking on the spore where it was attached to a spore-producing cell.

**homomorphic** Composed of similar cell types.

**homothallic** Having one strain type that is, by nature, dikaryotic and *self-fertile*; often arising from two spored basidia.

**humicolous** Growing in humus, soil.

**hygrophanous** Markedly fading in color upon drying, used to describe the condition of the mushroom cap.

**hymenium** The layer of fertile spore-bearing cells on the gill.

**hypha, hyphae** Individual cells of mycelium.

**hyphal aggregate** A concentration of mycelium; a "knot" in the mycelial network which often differentiates into a primordium.

**hyphosphere** The region immediately on and surrounding *hyphae*.

## i

**indicator mold** A mold, usually non-destructive, whose occurrence indicates an improperly balanced *condition* in the substrate or environment.

**instar** An insect in any of its stages of post embryonic growth.

## k

**karyogamy** The fusion of two sexually opposite nuclei within a single cell.

**KOH** Potassium Hydroxide, an agent commonly used to revive dried mushroom material for microscopic study at a concentration of 2½%.

## l

**lamellae** Mushroom gills.

**lignicolous** Growing in wood or on a substratum composed of woody tissue.

**lignin** The organic substance which, *with* cellulose, forms the basis of most woody tissue.

**linear** Considerably longer than wide, with edges parallel.

**lubricous** Smooth



**lumen** The amount of the flow of light emitted from a single international foot candle.

lux The amount of illumination received by a surface one meter from 1 foot candle, equal to 1 lumen/square meter.

## m

**macroscopic** Visible to the unaided eye, matting A condition of a mycelium casing-run that has become appressed from overwatering. Similar to overlay except that matting infers the mycelium has formed a dense, dead layer of cells on the casing's surface.

**meiosis** The process of reduction division by which a single cell with a diploid nucleus subdivides into four cells with one haploid nucleus apiece.

**membranous** Being sheath-like in form.

**mesophile** An organism thriving in moderate temperature zones, usually 40-90°F.

**metuloid** Used to describe a sterile cell encrusted with a crystalline (calcitized) substance.

**micron** One millionth of a meter,  $10^{-6}$  meters, one thousandth of a millimeter.

**microscopic** Visible only with the aid of a microscope.

**mitosis** The non-sexual process of nuclear division in a cell by which the chromosomes of one nucleus are replicated and divided equally into two daughter nuclei.

**monkaryon, monocaryon** (*adj. monokaryotic, monocaryotic*) The haploid state of the mushroom mycelium, typically containing a single nucleus.

**mottled** Spotted, as in the uneven ripening of spores on the gill surfaces that so characterizes species in the genus *Panaeolus*.

**mushroom** A fleshy fungus that erects a body of tissue in which sexual spores are produced and from which they are distributed.

**mycelium** (*pl. mycelia*) A network of hyphae.

**mycology** The study of fungi.

**mycophagist** A person or animal that eats fungi.

**mycophile** a person who likes mushrooms.

**mycophobe** a person who fears mushrooms.

**mycorrhizal** A peculiar type of symbiotic relationship a mushroom mycelium forms with the roots of a seed plant, typically trees.

## n

**nanometer**  $10^{-9}$  meters, one thousandth of a micron.

**natural culture** The in vitro cultivation of mushrooms by transplanting living mycelium, usually from a natural habitat.

**nomenclature** Any system of classification.

**nucleate** Having nuclei

nucleotide One of the four nitrogenous bases in DNA; often called the building blocks of the DNA molecule.

**nucleus, nuclei** A concentrated mass of differentiated protoplasm in cells containing chromosomes and playing an integral role in the reproduction and continuation of genetic material.

## O

**obtuse** Bluntly shaped.

**ochraceous** Light orangish brown to pale yellowish brown.

**oidia** Conidia (spores) borne in chains.

**olivaceous** Olive gray-brown.

**overlay** A condition of the casing where mycelium been allowed to completely cover the surface. *Overlay* is caused by prolonged vegetative growth temperatures, high CO<sub>2</sub> levels and excessive humidity. *Overlay*, if *overwatered*, becomes matted.

**ovoid** Oval shaped.

## P

**pallid** Pale in color.

**parasite** An organism living on another living species and deriving its sustenance to the detriment of the host.

**partial veil** The inner veil of tissue extending from the cap margin to the stem and at first covering the gills of mushrooms.

**pasteurization** A process by which bulk materials are partially *sterilized* through contact with live steam, hot water or dry heat at temperatures of between 140-160 °F.

**pellicle** A skin-like covering on the cap, sometimes gelatinous and separable.

**pencilate** Resembling a broom or brush; *Penicillium*-like.

**perithecium** A flask shaped or pear shaped saclike *fruitbody* of some Ascomycetes that encloses asci.

**persistent** Not disappearing with age.

**Phase I** The steps taken in the outdoor preparation, assemblage and conversion of raw materials into a nutritious medium for mushroom growth.

**Phase II** The pasteurization and final conditioning of a mushroom compost.

**phenotype** The observable physical characteristics resulting from interaction between the host environment and the genotype.

**photosensitive** Sensitive to light.

**phototropic** Growing towards light.

**pileus** The mushroom cap.

**pith** The central cottony "stuffing" in the stems of some mushrooms.

**pleurocystidia** Sterile cells on The surface of mushroom gills. Sometimes called facial *cystidia*.

**pliant** Flexible.

**pore** A circular depression at the end of spores in many species.

**primary mycelium** The haploid and uninucleate mycelium *originating* from the germination of a spore which is otherwise not capable of producing a sporulating organ.

**primordium** (*pl. primordia*) The first recognizable but undifferentiated mass of hyphae that develops into a mushroom fruitbody. Synonymous with "pinhead".

**pruinose** Having a powdery appearance.

**pseudorhiza** A long root-like extension of the stem.

**pseudosclerotium** (*pl. pseudosclerotia*) A conglomerated mass of mycelial tissue resembling a sclerotium but which can not produce a fruitbody or new mycelial growth.

**psilocybian** Having psilocybin and/or psilocin. (Not necessarily belonging to the genus *Psilocybe*).

**psilocyboid** Resembling a *Psilocybe* mushroom.

## I

**radicate** Tapering downwards. Having a long root like extension of the stem.

**reticulate** Marked by lines or ridges.

**rhizomorphs** Cord-like or strand-like hyphae.

## S

**SACing** Nutrient supplementation of bulk substrates at the time of casing.

**saprophyte** A plant (fungus) That lives on dead organic matter.

**saltation** The mutation developing from an isolate of mycelium having a known pure genotype.

**scanning electron microscope** An electronic microscope which **scans** an object in a vacuum with a beam of electrons resulting in an image of high resolution and magnification that is then displayed on a television-type monitor.

**sclerotium** (*pl. sclerotia*) A hardened mass of mycelium, usually darkly pigmented, that is the resting (*vegetative*) phase in some fleshy and non-fleshy fungi, and from which fruitbodies or viable mycelium can arise.

**scratching** Ruffling of the substrate or casing **surface** in order to maintain an **open**, porous condition conducive to primordia formation.

**seceding** Describing the condition where the gills have separated in their attachment to the mushroom stem and have torn *free*, usually leaving longitudinal ridges at the **stem's** apex.

**sector** A geometric growth of diverging mycelium (most visible on media filled petri dishes), the appearance of which contrasts with that of neighboring mycelia, usually indicative of genetic mutation.

**secondary mycelium** A dikaryotic and binucleate mycelium characterized by clamp connections, crossing (anastomosis), and which is assimilative, not generative, in function.

**senescent** Having grown old.

**septate** Having walls dividing cells.

**sinuate** Describing the attachment of the mushroom gill to the stem at the junction of which the gill appears notched.

**somatic** Being in the assimilative phase of mycelial growth.

**sordid** Dirty looking.

**spawn** The aggregation of mycelium on a carrier material which is usually used to inoculate prepared substrates.

**spores** The reproductive cells or "seeds" of fungi, bacteria, and plants.

**sporocarps** Any fruitbody that produces spores.

**sterigmata** (*pl. sterigmatae*) Elongated appendages or "arms" extending from the apex of the basidium and upon which spores form.

**stipe** The stem or stalk of a fungus.

**strain** A race of individuals within a species sharing a common genetic heritage but differing in some observable features of **no taxonomic** significance.

**stroma** A dense, cushion-like aggregation of mycelium forming on the surface of composts or casings and indicative of somatic (*vegetative*), not generative growth.

---

# APPENDIX I

## THE MEDICINAL PROPERTIES OF MUSHROOMS

Mushrooms have long been esteemed for their medicinal properties, especially by Far Eastern cultures, while western cultures have largely been oblivious to the beneficial properties of mushrooms. For centuries, the Japanese have hailed the shiitake mushroom (*Lentinus edodes*) as an elixir of life, a cure-all, revitalizing both body and soul, a cure for cancer, impotency, senility and a host of other ailments. Mazatec shamans of southern Mexico have used *Psilocybe* mushrooms in their divination and healing ceremonies, extolling them for their life-giving properties and calling them "Mushrooms of Superior Reason" for the heightened mental state they induce. Even the very term "agaric," still used to describe all mushrooms with gills, comes from the name of a pre-Scythian people, the Agari, who were skilled in the use of medicinal plants, of which mushrooms were one.

Not until the late 1920's, when Dr. Alexander Fleming published a note in a microbiological journal, did fungi draw the scrutiny of scientists looking for new sources of antibiotics. He observed, quite by accident, the deterrent effect a *Penicillium* mold had on a bacterial contaminant (a *Staphylococcus* species). Years later, fellower researchers pursued his suggestion that antibiotics were being produced by this mold, which shortly led to the discovery of penicillin. Forthwith, molds of all types were examined by W.H. Wilkins (and others) from 1945 to 1954 who systematically tested one hundred species at a time for antibiotic effects against bacteria and bacteria-carrying viruses. Eventually, Wilkins turned his attention to the fleshy fungi and interest within the scientific community grew.

Claims of healing properties in mushrooms have been primarily promoted, until recently, by the commercial mushroom industry and others with vested interests. It appears, however, much of the medicinal claims attributed to mushrooms are not myth, but founded in some truth. Within the last ten years, numerous studies demonstrating the anti-cancer and interferon stimulating properties of *Lentinus edodes* have been published. Individuals can significantly reduce serum cholesterol levels by eating these mushrooms for as short a period as a week (Suzuki and Ohshima, 1974). In another study (Hamuro et al., 1974), the antitumor influence of hot water extracts of *Lentinus edodes* was demonstrated in mice implanted with sarcoma-180 and other cancers, resulting in a 80% remission from treatment lasting only ten days, and a 100% prevention of growth if the mice were injected prior to implantation. The causal compound is appropriately named lentinan, an anti-tumor polysaccharide. Extracts from shiitake spores and the isolation of "mushroom RNA" from them have proved effective against influenza (Suzuki et al., 1974). Similar antitumor, immunopotentiator and interferon stimulating polysaccharides have been found in *Boletus edulis*, *Calvatia gigantea*, *Coriolus versicolor*, *Flammulina velutipes*, *Ganoderma applanatum*, *Ganoderma*

---

*lucidum* (the classic "Reishi Mushroom"), *Phelinus linteus*, *Armillaria ponderosa* (*Tricholoma matsutake*) and *Pholiota nameko*. (See Yamamura and Cochran, 1974).

In the treatment of other diseases, Cochran and Lucas (1959) reported *Panaeolus subbalteatus*, a mushroom producing psilocybin and psilocin, provided significant protection from polio virus in mice as did several other edible and inedible mushroom species. Psilocybian mushrooms might be of further usefulness in improving eye sight, hearing, circulation and in activating the self-healing processes within the human body.

With the current emphasis on prevention and natural cures for human diseases, mushrooms are proving to be a convenient, inexpensive and an effective method of sustaining health. Health conscious individuals beginning a daily regimen of eating shiitake, for instance, have been shown to be less susceptible to virus-induced diseases than those abstaining. Until these studies progress and are tested more extensively on human populations, hopes should not be unduly raised for mushrooms might be of further usefulness in improving eye sight, hearing, circulation and in activating the self-healing processes within the human body.

---

# APPENDIX II

## LAMINAR FLOW SYSTEMS

Suspended in the air is an invisible cloud of contaminants. These airborne spores are the primary source of contamination during agar and grain culture, and they are the major force defeating beginning cultivators. To control contamination, the cultivator must start with a sterile laboratory. Without pure culture spawn, the prospect for a good crop is slight, no matter how refined one's other techniques.

Creating an absolutely sterile environment, free of all airborne particulates, is extremely difficult, if not impossible. "Nearly sterile" environments are more easily constructed and are quite suitable for the purposes of the mushroom cultivator.

Chemical cleaners like detergents and disinfectants have traditionally been used for this purpose. Unfortunately, the frequent use of these cleaners to maintain hygiene in the laboratory pose some risk to the handler. Ultraviolet lights are likewise dangerous and are difficult to position in a room so that no shadows are cast. By far the least harmful and most effective method is the use of high efficiency filters that screen out airborne particulates when air is pushed through them. These filters are the basis of laminar flow systems. An understanding of the composition of unfiltered air helps put into perspective the problem for which laminar flow systems are designed. The air, the filter, the fan and the laminar flow system will be discussed in that order.

### The Air

Air is composed of many suspended and falling particles. A sample of air holds soot or smoke, silica, clay, decayed animal and vegetable matter, and many, many spores. Some are only a fraction of a micron in diameter while other are hundreds of times larger. These particles continuously rain down on the earth's surface. In light impact zones isolated from industrial centers, twenty tons per square mile per month fall from the sky (ASHRAE, 1978). Industrial areas have a fall-out that is ten times greater. So-called "clean country air" contains, on the average, one million particles (greater than .3 microns) per cubic foot. But in a room where a cigarette is being smoked, more than one hundred million particles are suspended in the same air space. A sterile laboratory, on the other hand, has less than one hundred particles per cubic foot of air!

Most of the spores contaminating mushroom cultures are between .5 and 20 microns in diameter. Generally, particles greater than 10 microns fall out of the air because of their weight. The smallest particles in this group are the airborne spore-forming bacteria which originate from soils. The smallest endospore forming bacteria are around .4 microns in diameter. Viruses which measure even smaller, sometimes a mere .05 of a micron in size, are usually attached to larger particles such as fungal spores. This broad assortment of airborne debris poses the greatest danger to mushroom culture.

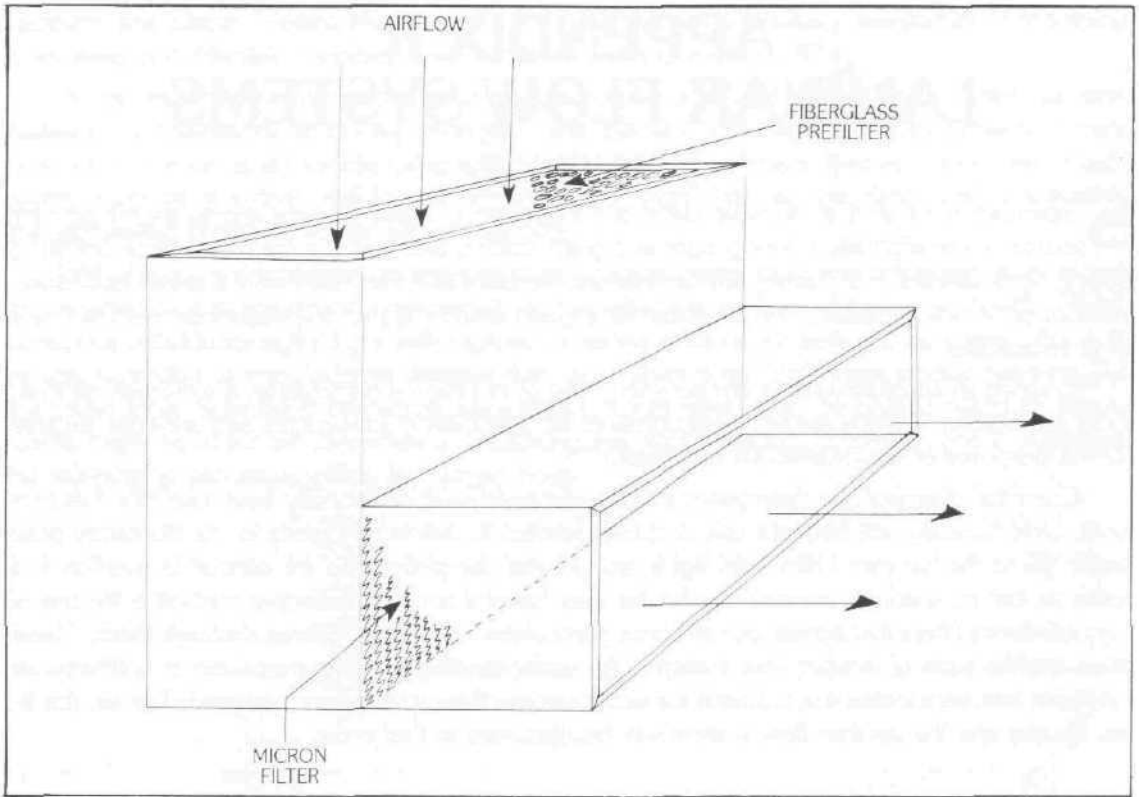
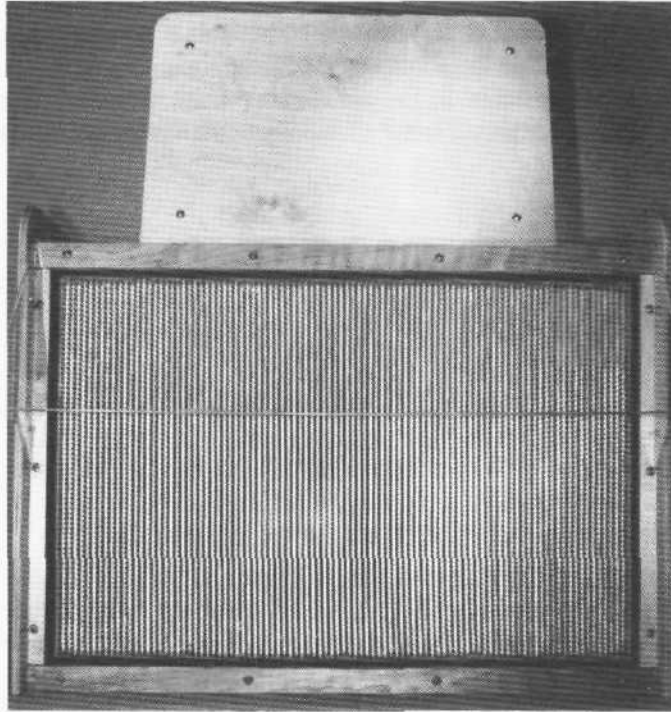

**Figure 239** A standard design of a laminar flow cabinet for tissue culturists.

## The Filter

Two types of high efficiency filters are available today. One is an electrostatic filter which will screen out spores down to 5 microns or less. These filters operate on a charged particle principle where, by a variety of means, airborne particles are passed through an ionizing field and then between two oppositely charged electrical plates. Charged particles are drawn to the grounded plate by the force of the electric field. Because an agglomeration of particles is likely to blow off the retaining plate. They are often coated with a special oil. The advantages of electrostatic filters are that they have little resistance (a low pressure drop) and that they are reusable. But they have several disadvantages. One disadvantage is that they do not screen out the particles of 1 micron or less with a 99 + % efficiency in high velocity airstreams. Hence, as air velocity increases, their efficiency decreases. Many electrostatic filters have, as a result, a sliding scale of efficiencies based on air speed. Another problem associated with electrostatic filters is that particles not caught in the filter are still partially charged and stick to the walls of a room, discoloring them. Also, toxic ozone may be generated by the constant arcing in the electrostatic field.

The basic element in an air filter is the media, particularly the dry extended surface kind that is



**Figure 240** A commercially available laminar flow hood.

rated to .3 or .1 microns. Extended surface filters are commonly known as HEPA (High Efficiency Particulate Air) filters. First used commercially in 1961, these filters are honeycombed with fine sheets of microporous material that can screen out particulates down to less than one third of a micron size with a rated 99.99% efficiency. All spores of plants, fungi and most bacteria are thereby trapped within the folds of the filter.

The collection media in this type of filter can be composed of various materials including hair, spun glass, wool, paper and asbestos. (In the past, asbestos has been used in the manufacturing of all types of filters. Since asbestos is cancer causing, be sure to specify a non-asbestos fiber). The extended surface media filter consists of folds of material woven back and forth. Corrugated aluminum or paper separators are inserted perpendicularly to the filter face and separate the folds to help direct airflow in an even, parallel fashion.

The airstream hits the filter material at a perpendicular angle and is forced to pass through the many weaves of the filter before exiting. From the force of impact, inertia and the size of the media web, particles are trapped within the filter. The result is that a very high efficiency is achieved, particularly with small diameter particles.

Extended surface filters have much higher resistance than electrostatic filters but they have a far



greater capacity for holding dust. As the filter traps dust, it increases in weight and airflow declines. Generally a HEPA filter is not reused but discarded when, as a rule of thumb, the resistance or "pressure drop" doubles. Extended surface filters are used in hospital surgery rooms as well as culture laboratories and nuclear facilities. Since its efficiency is somewhat dependent on the impact velocity of the particle striking the media web, an appropriate fan must be matched with this type of filter.

## The Fan

When constructing a laminar flow hood, the filter size must be precisely fitted with a high pressure fan. All fans are rated by the manufacturer according to the volume of air (CFM or cubic feet per minute) they can push past materials of specified resistance. The type of high pressure fans needed in a laminar flow hood are usually of the squirrel cage type ("furnace blowers").

In turn, the resistance of all micron filters are measured in inches of static pressure at a certain air speed. A standard resistance for a micron filter of this type is .75-1.00 inches of static pressure. Because extended surface filters have a high initial resistance, the housing must tightly hold the HEPA filter so that impure air is not sucked into the exiting airstream.

To calculate the correct fan/filter combination, take the net CFM of the fan at the filter's rated level of resistance and divide that number by the square footage of the filter face. Ideally, that number will be 100 feet per minute, the optimum range for air velocity in laminar flow systems. An example will more clearly illustrate this basic principle.

IF a micron filter measures 2 feet long by 2 feet high by 6 inches deep and has a static pressure rating of 1.0 inches of resistance, the fan required would have to be capable of pushing 400 CFM at 1 inch of static pressure.

IF  $X$  = the desired net CFM of a fan at 1" S.P. and

$Y$  = 4 square feet (the square footage of the filter face)

THEN  $X$  = 100 feet per minute  $\times$   $Y$

$X$  = 100 feet per minute  $\times$  4 square feet

$X$  = 400 cubic feet per minute

This means that a fan capable of pushing 400 cubic feet per minute at 1 inch of static pressure is needed to yield the optimum air velocity of 100 feet per minute. (Note that different filters have different static pressure ratings and suggested CFM's). In selecting a fan, it is best to choose one that can deliver more than a 100 feet per minute air velocity. Install a solid state speed control to regulate the fan as needed.

As the filters become laden with particulates, the resistance increases and the airflow declines. If the airflow falls below 20% of the suggested optimum, the 99.99% efficiency rating can not be guaranteed. Filters of the size in the example above can hold four or more pounds of dust and spores before needing replacement! With a few hours of use every week (the time most home cultivators spend conducting sterile transfers), the micron filter should last many years, depending of course, on the ambient spore load in the laboratory.

---

The life of a HEPA filter can be extended with the placement of prefilters to screen out coarse particulates. Prefilters can be made of fiberglass media, the type commonly used for furnace filters, or they can be composed of a thin open-celled foam. Prefilters of the latter type increase resistance significantly whereas furnace type filters increase resistance only slightly. In this regard, furnace filters are well suited because they are cheap (less than five dollars), readily available, and come in numerous sizes.

## Laminar Flow Designs

There are several types of laminar flow systems, each designed for specific applications. The airflow in a biological safety cabinet, built for use with pathogenic organisms, is such that the worker is not endangered if spores from a virulent organism became airborne. The air is drawn from the work area into the hood and then up through micron filters and exited to the outside. Laminar flow hoods for work with radioactive and toxic materials are similarly designed. Because of their intri-

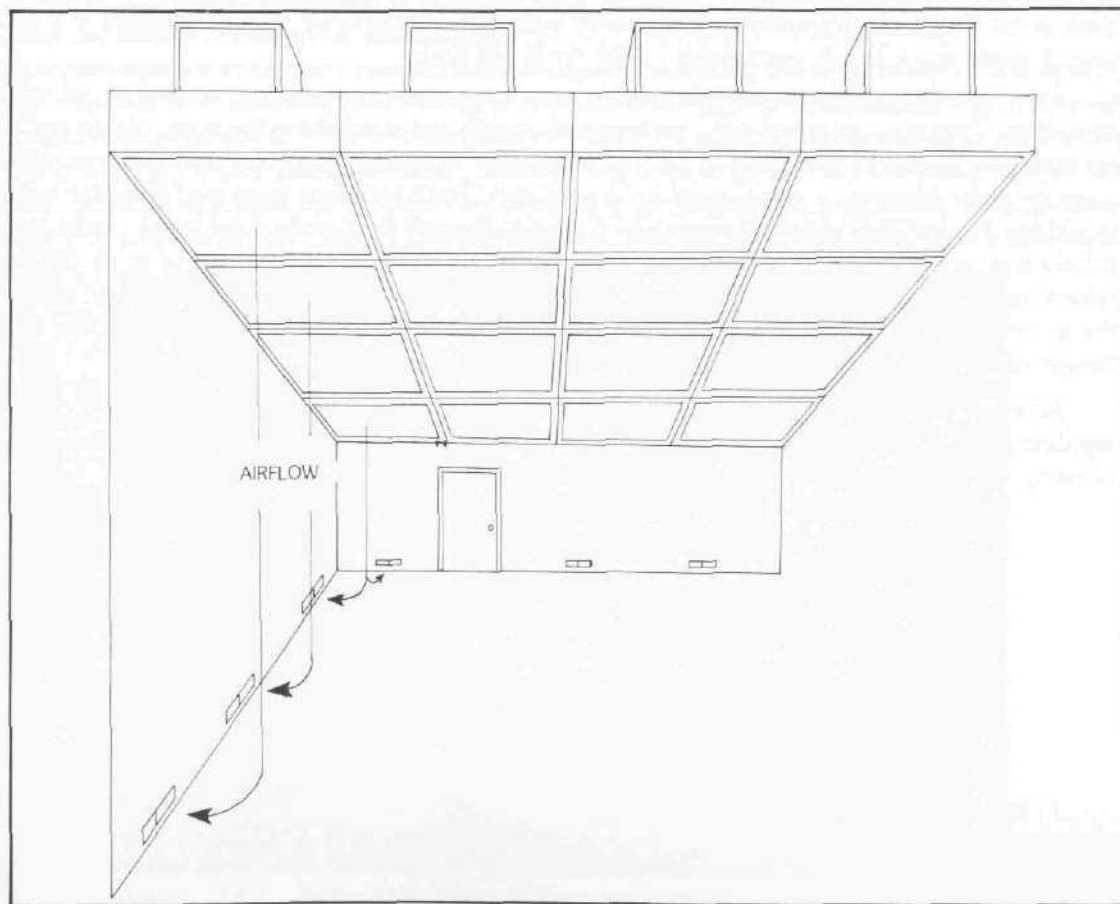

**Figure 241** Sterile room with ceiling composed of micron filters.

cacy, they are considerably more expensive than the kind needed for mushroom and plant culture.

Laminar flow systems for tissue culturists operate on a reverse principle of the one designed for use with toxic substances. Air is forced through a micron filter to the work area, creating a positive pressure sterile wind in which to conduct mycelial transfers. These types of hoods are perfect for pouring media, maintaining pure mycelia and inoculating spawn containers. Since they greatly reduce the waste caused by contamination, their cost is soon offset by the savings realized. A laminar flow hood is a low maintenance, affordable and appropriate technology for the serious home cultivator.

An alternative to building a laminar flow hood is the construction of a laminar flow wall or ceiling. A laminar flow ceiling is preferable because the draft is directed downwards to the floor where it exists through evenly placed pressure activated dampers. When a wall or ceiling is composed of micron filters, the air is usually drawn from the outside where the prefilters can be changed without entering the sterile laboratory. Any contaminant spores tracked in on the shoes of workers are kept close to the floor and is immediately swept away by the flow of sterile air. The atmosphere in a this type of sterile room is fully exchanged 10-20 times per hour.

Foremost, tissue culturists are interested in preventing contamination from occurring, not from spreading. They are concerned with creating sterile media and maintaining the purity of cultures. A laminar flow hood is of little value in helping a cultivator isolate a colony of mushroom mycelium away from, for instance, a green mold on a petri dish. The turbulence generated from the hood would free thousands of spores, some of which would adhere to the surface of the sterile media, germinate and produce more spores. In these cases, a laminar flow hood is best used as an air cleaner prior to isolating a culture away from a contaminant. Several minutes after it has been turned off and the air currents have settled, transfers can be made away from neighboring contaminants with little danger of airborne spores.

Although sterile work can be conducted without a laminar flow system, they have become a standard piece of equipment in professional spawn laboratories and increasingly in the sterile rooms of many home cultivators.

# APPENDIX III

## THE EFFECT OF BACTERIA AND OTHER MICROORGANISMS ON FRUITING

**A**lthough mushrooms have been cultivated for more than two hundred years, little is known about the biological processes of fruiting. For mushroom pinheads to form suddenly and then to enlarge into towering mushrooms within only a few days represents a many hundred-fold multiplication in biomass. This ability to generate tissue so rapidly has few parallels in nature and has been the subject of numerous scientific papers.

Mushrooms are in constant competition with organisms sharing the same habitat. Dung inhabiting mushrooms in particular (like *Psilocybe cubensis* and *Agaricus brunnescens*) live in an environment that teems with other microorganisms feeding on organic wastes and dead cell matter. Dung is by nature a temporary substrate, decomposing completely in only a few weeks. Within this short period of time there is a succession of dominant microorganisms, most notably fungi and bacteria. For a new mushroom colony to grow, its spores must fall, germinate, mate, form a substantial

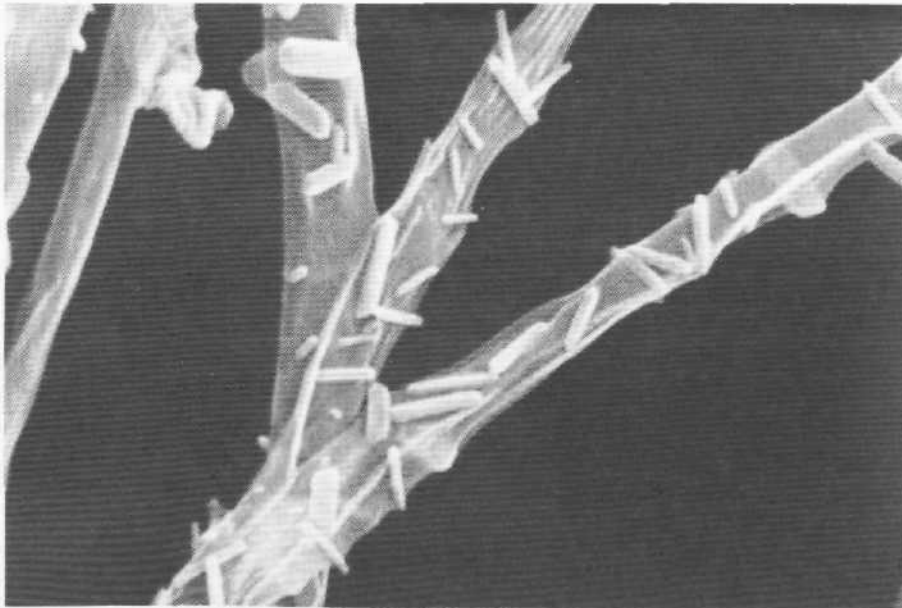

Figure 242 *Psilocybe cyanescens* mycelium contaminated with bacteria.

mycelial network and then produce a specialized fruitbody. This series of events is made less likely by poor weather conditions and/or competing microorganisms. The brevity of the generative phase in the mushroom life cycle suggests a highly advanced metabolic system, one that has evolved despite its fiercely competitive environment.

The fact that *Agaricus brunnescens* fails to fruit on sterilized substrates has been well documented. It has been shown that if the casing layer is sterilized and applied to grain or compost, mushrooms do not form. On the other hand, if the casing layer is only pasteurized or left untreated, fruiting is unhindered. Obviously something in the peat based casing is essential to the fructification process.

Past investigations have shown the significance of bacteria in mushroom growth. It should not be surprising then to learn that some of these microorganisms are not harmful to the mushroom plant, but beneficial. Under conditions of high humidity, CO<sub>2</sub> and acetone, bacterial populations spiral. In a way not presently understood, some of these bacteria act as a trigger to fruiting. The prevalence of bacteria on hyphae may explain why most dung dwelling mushrooms can be fruited with comparative ease on basic enriched agar media while wood and soil inhabitants can not. The association of these two organisms, a fungus and a bacterium, reflects a tacit agreement for mutual co-existence, one perhaps negotiated by evolutionary necessity.

In 1956 Dr. Takashi Urayama first noted the stimulative influence of bacteria on the fruiting of *Psilocybe coprophila*. (Actually he misidentified the mushroom species as *P. panaeoliformis*). In that paper and ones soon thereafter (Urayama 1960, 1961 and 1967), he reported the isolation of a bacterium he thought responsible for fruiting in not only *Psilocybe "panaeoliformis"* but also in *Agaricus brunnescens*. He named that bacterium *Bacillus psilocybe* nom. prov. Apparently unaware of Urayama's work, a German mycologist named Eger similarly isolated a bacterium stimulative to pinhead formation. She first published her notes in 1959. For years this bacterium was known as "Eger's Bacterium" until Hayes (1969) identified the organism in question as *Pseudomonas putida*. This identification set in motion other research projects whose conclusions revealed a subtle but dynamic interplay between microflora in the casing layer and the mushroom mycelium.

Mushroom mycelium releases several metabolites as it grows through a substrate, most importantly CO<sub>2</sub>. Other compounds identified by researchers as metabolic waste products include acetone, ethanol and ethylene. Upon casing, the release of volatile metabolites from the spawned compost or grain is drastically inhibited. The casing layer interferes with the free diffusion of acetone, and hence its concentrations in the casing biosphere increase. Since *Pseudomonas putida* grows on media whose sole carbon source is acetone or ethanol (2.5%), cultivators can adopt measures that will enhance the levels of these *Pseudomonas* propagating compounds in the casing layer. Eger first suggested a practical application for commercial cultivators:

"In order to prove our hypothesis, freshly prepared, moist casing soil of a commercial mushroom plant should be incubated with acetone for several days apart from mushroom cultures. If acetone has a stimulative effect on the microflora that induces fructification, soil treated with acetone should allow earlier pinhead formation than control samples." (Eger, 1972, pp. 723.)

Two years later Hayes and Nair (1974) noted that more bacteria flourish in wet casings placed

on compost than in wet casing alone. Peak activity occurred ten days after application. Dry casings, as one would expect, had significantly fewer bacteria. Continuing with this work, Hayes and Nair showed that the addition of 5% spawned compost into the casing layer resulted in the largest increase in *P. putida* populations, the most pinheads and the greatest overall yields.

Stanek (1974), a Czech mycologist, studied the bacteria associated directly with mushroom mycelium, in the zone he called the "hyphosphere". These hyphosphere bacteria differed from other bacteria in that they were predominantly Gram-negative (as is *Pseudomonas putida*) and they utilized nitrogenous compounds secreted by the mycelium. Both the growth of mycelia and bacteria were stimulated by extracts of one another, suggesting a mutually enhancing relationship much like the one between nitrogen fixing bacteria and the roots of many plants. Stanek further determined that mycelium infected with bacteria grew more quickly through compost and would, therefore, give mushroom mycelium a decided advantage over other competing microorganisms. From this author's experience (Stamets') in the course of studying the hyphosphere of several *Psilocybe* species, bacteria are not uncommon and may play a similarly beneficial role.

Not all strains of *Pseudomonas putida* cause pinheads to form in *Agaricus brunnescens*, nor do all strains of mushrooms respond similarly to the presence of selected bacteria. The two proven stimulative strains, ATCC #12633 and #17419, are deposited with the American Type Culture Collection. Some strains of *Pseudomonas putida* have no effect whatsoever, while others are most stimulative if the bacterial colonies are grown on a 2.5% acetone based liquid media (see Eger, 1972). After incubating for 10 days at 25°C. in 30-40 ml. of nutrient broth, a density of 1,000,000 to 2,000,000 cells/milliliter is achieved. Ten milliliters of this concentrated solution is recommended for each square meter of casing surface. (For ease of application, one milliliter of concentrate can be diluted in 100 milliliters of sterilized water).

Eger, Hayes and Nair have demonstrated the stimulative effect of *Pseudomonas putida*. But why *Pseudomonas putida* stimulates primordia formation is a question yet unanswered. Some believe its effect is indirect, removing chelating compounds that inhibit mushroom initiation. Others (Fritsche, 1981; Visscher, 1981) suspect its influence is more direct and biologically oriented.

*Pseudomonas putida* is not the only microorganism implicated in the phenomenon of fruiting. Park and Agnihorti (1969) published a short note where they compared bacteria introduced to soils that had been autoclaved, gamma sterilized and untreated. Three other bacteria (*Bacillus megaterium*, *Arthrobacter terregens* and *Rhizobium meliloti*) stimulated abundant fruitbody formation and development on sterilized soils. (Interestingly, these same nitrogen fixing bacteria are presently being marketed to farmers for increasing crop production). In yet another study, Curto and Favelli (1972) examined a gamut of microorganisms (bacteria, yeasts and microalgae) and their effect on potentiating yields. Again, *Bacillus megaterium* significantly increased mushroom formation. Even more remarkably *Scenedesmus quadricauda* (a common pond dwelling blue-green alga) enhanced production by nearly 60% over and above the control. This alga seemed to have a particularly influential effect on the number of primordia generated on the first flush. Although as exciting as these findings may at first appear, it must be noted that other researchers have not yet confirmed the findings of Curto and Favelli. For reasons not presently understood, activated char-

coal mimics the primordia stimulating properties of *Pseudomonas putida* and other beneficial microorganisms. (See Chapter VIII). Its addition to unsterilized casings seems wholly unnecessary considering the ease with which *Agaricus brunnescens* and *Psilocybe cubensis* form pinheads. But, in sterilized casings or in casings applied to difficult to fruit species, the use of activated charcoal and select bacteria gives the cultivator another means to promote fructification. Although many studies have been published, work with fruiting potentiators is still in its infancy. Specific mushroom strains must be carefully matched with specific strains of potentiators. And the potentiators themselves, while of value at fruiting, can be formidable competitors to sterile culture in the laboratory. Nevertheless, utilizing these benevolent microorganisms holds great promise for the future of mushroom culture.

NOTE: Bacteria, if cultured, must be kept separate from the mushroom culture laboratory. *Pseudomonas* and *Bacillus* grow well on standard 2% malt agar media.

# APPENDIX IV

## THE USE OF MUSHROOM EXTRACTS TO INDUCE PRIMORDIA FORMATION

The search for the biochemical means by which mushrooms fruit has been ongoing for years. Several researchers have demonstrated the influence of hormones in regulating mushroom formation and development. From this work, it is clear that no one mechanism, but many, cause the phenomenon of fruiting.

Urayama (1972) found that live extracts from young buttons of *Agaricus brunnescens* and from other species would induce pinhead initiation in a *Marasmius* species that otherwise failed to fruit on a specified agar medium. He determined that this particular *Marasmius* failed to form fruitbodies on agar media that had a carbon:nitrogen ratio of 1:10 with sucrose levels maintained at 1%. Given the inability of pinheads to form at this Sucrose/Peptone ratio, he could introduce standardized cell free extracts of other mushroom species to gauge their effects. Species from which crude extracts were taken were: *Agaricus brunnescens*, *Lentinus edodes*, *Flammulina velutipes* and *Pleurotus ostreatus*. The extracts were prepared by washing 200 grams of homogenized live mushroom tissue (primordia less than 1 cm. tall) with four successive baths of 80% methanol. The residue was discarded each time and the methanol solution allowed to evaporate, under a slight vacuum, until a dried filtrate remained. One gram of this crude extract was then immersed into 10 milliliters of water and applied in  $\frac{1}{10}$ th milliliter increments to each culture tube, except for the controls.

The results of Urayama's work showed that each of the four fractionations induced primordia formation provided aqueous methanol (80%) and only young mushrooms were used. Extracts from older fruitbodies, especially that of *Agaricus brunnescens* and *Lentinus edodes*, had no effect whatsoever. Urayama tried other solvents to isolate the mysterious "fruiting hormone" and discovered that it was soluble in water and not soluble in absolute methanol, chloroform or petroleum benzene. He worked on his "Substance X", as he liked to call it, for many years until his death in 1980.

Shiio et alia (1974) realized that young mushroom buttons contained high concentrations of the fruiting hormones and applied this knowledge to the commercial cultivation of *Flammulina velutipes*. Pieces of *Flammulina velutipes* primordia were immersed into sterile water and sprayed over sawdust/bran beds. Not only were yields substantially increased by this crude procedure, but initiation occurred much earlier, and the overall fruiting cycle was narrowed considerably. Clearly these mycologists were on the road to discovering an important link in the biochemistry of fruiting.

Around the same time as the work of Shiio et alia, two other Japanese mycologists published related studies (Uno & Ishikawa, 1971, 1973) whereby pinheads of *Coprinus* formed if a "cell free extract" from young mushrooms was added to the culture. They and others isolated the causal



compounds—cyclic adenosine monophosphate (c AMP) and related enzymes. They further found that light stimulated the production of c AMP in the mycelium of phototropic mushroom species. Conversely, the absence of light in phototropic mushroom species resulted in no production of c AMP.

Wood (1979) tried to substantiate the findings of Uno and Ishikawa with *Agaricus brunnescens* and failed. He could not induce primordia to form using c AMP. However, this fact does not bear any significance on the importance of cyclic adenosine monophosphate in phototropic species since *A. brunnescens* is a mushroom needing no light whatsoever for primordia formation and development.

The question of how mushrooms fruit is not simple; nor will there be one answer explaining the mechanisms in all species. What is apparent at this early stage of research is that photosensitive and non-photosensitive species have developed different means for mushroom development. The information most useful for home and commercial cultivators will come in the areas of yield enhancement and the growing of exotic mushrooms on readily available, cheap materials. By good fortune, this is one area of research that is not beyond the means of the innovative home cultivator.

---

# APPENDIX VII RESOURCES FOR MUSHROOM GROWERS

## Suppliers of Cultures of Edible Mushrooms

American Type Culture Collection  
12301 Parklawn Drive  
Rockville, Maryland 20852

Pennsylvania State University  
2111 Buckhout Laboratory  
University Park, Maryland 16802

## General Supplies & Equipment

Fungi Perfecti  
PO Box 7634  
Olympia, Wa. 98507  
Phone:360426-9292  
Fax:360-426-9377

Home Page: [www.fungi.com](http://www.fungi.com)

Products include: micron filters; laminar flow hoods; sterile and room supplies; pressure cookers; steam boilers; cultures; sterile and growing room instruments; pure cultures and spawn. Write for free brochure or include \$4.50 for our fully illustrated catalogue. International orders welcomed.

## Commercial Spawn Makers

Rainforest Mushroom Spawn  
International Division  
PO Box 1793  
Gibsons, B.C.  
Canada VON WO

Spawn of these species available: *Pleurotus ostreatus*; *Pleurotus sajor-caju*; *Pleurotus cornucopiae*; *Pleurotus eryngii*; *Lentinus edodes*; and *Stropharia rugoso-annulata*.

## Publications

*The Mushroom Journal* (monthly)  
The Mushroom Growers Association (MGA)  
Agriculture House  
Knightsbridge  
London, SW1X 7NJ  
(Available in large university libraries.)

*The Mushroom News* (monthly)  
American Mushroom Institute (AMI)  
Box 373  
Kennett Square, Pa. 19348  
(Available in large university libraries.)

Mushroom Growing Bulletins  
Dr. Paul Wuest  
Department of Botany  
Pennsylvania State University  
University Park, Pa. 16802

*Mycologia*  
The New York Botanical Garden  
Bronx, New York 10458

*Mushroom Newsletter for the Tropics*  
(quarterly)  
The International Mushroom Society for the Tropics  
c/o Department of Biology  
The Chinese University of Hong Kong  
Shatin, N.T. Hong Kong

## Organizations

North American Mycological Association  
(NAMA)  
4245 Redinger Rd.  
Portsmouth, Oh. 45662

The Mycological Society of America (MSA)  
c/o Dr. Harry Thiers  
Department of Biology  
San Francisco State University  
1600 Holloway Ave.  
San Francisco, Ca. 94132

MycoMedia  
PO Box 2222  
Olympia, Wa. 98507  
(Sponsors yearly forays and educational conferences.)

Puget Sound Mycological Society  
2161 E. Hamlin  
Seattle, Wa. 98112

# APPENDIX VIII

## METRIC CONVERSION TABLES

Cropping Yield		Substrate Depths	
lbs./sq. ft.	kg./sq. m.	inches	centimeters
1.0	4.9	1	2.54
1.4	6.8	2	5.08
2.0	9.8	3	7.62
2.2	10.8	4	10.16
2.6	12.7	5	12.70
3.0	14.7	6	15.24
3.5	17.7	7	17.78
4.0	19.6	8	20.32
4.5	22.0	9	22.86
5.0	24.4	10	25.40
5.5	27.0	11	27.94
6.0	29.0	12	30.48
6.5	31.4		

### Length

Inch = 2.54 centimeters  
 Foot = 0.3048 meters  
 Yard = 0.9144 meters

Centimeter = 0.3937 inches  
 Meter = 3.2808 feet  
 Meter = 1.0936 yards

### Area

Sq. in. = 6.4516 sq. cm.  
 Sq. ft. = 0.0929 sq. m.  
 Sq. yd. = 0.8361 sq. m.

Sq. cm. = 0.1550 sq. in.  
 Sq. m. = 10.7639 sq. ft.  
 Sq. m. = 1.1960 sq. yd.

### Volume

Cu. in. = 16.3872 cu. cm.  
 Cu. ft. = 0.0283 cu. m.  
 Cu. yd. = 0.7646 cu. m.

Cu. cm. = 0.0610 cu. in.  
 Cu. m. = 35.3145 cu. ft.  
 Cu. m. = 1.3079 cu. yd.

**Capacity**

Cu. in. = 0.0164 liters

Liter = 61,0250 cu. in.

Cu. ft. = 28.3162 liters

Liter = 0.0353 cu. ft.

Cup = 0.2366 liters

Liter = 0,2642 gal.

Quart = 0.9463 liters

Liter = 1.0567 qt.

Gallon = 3.7853 liters

Liter = 1000 ml.

A liter of distilled water weighs 1000 grams or 1 kilogram.

**Weight**

Grain = 0.0648 grams

Gram = 15.4324 grains

Ounce = 28.3495 grams

Gram = 0.0353 ounces

Pound = 454 grams

Kilogram = 2.2046 pounds

Pound - 0.4536 kilograms

Metric Ton = 2,204 pounds

Ton = 907.1848 kilograms

**Pressure**

1 kg. per sq. cm. = 14.223 lb. per sq. in.

1 lb. per sq. in. = .0703 kg. per sq. cm.

1 kg. per sq. m. = .2048 lb. per sq. ft.

1 atmosphere = 1.0332 kg. per sq. cm. - 4.696 lb. per sq. in. = 1.0133 bars

**Temperature**

C	F
0	32
5	41
10	50
15	59
20	68
25	77
35	95
40	104
50	122
55	131
60	140
65	149
70	158
75	167
80	176

Fahrenheit to Centigrade

$$5/9 (°F - 32) = °C.$$

Centigrade to Fahrenheit

$$9/5 (°C) + 32 = °F.$$

**Miscellaneous Data**

50 lbs. rye grain = 125 cups (approximately)

$$\text{Area of a circle} = \pi(r)^2 = 3.14 \times r^2$$

**Strophariaceae** The family of dark brown spored mushrooms containing the genera *Melanotus*, *Naematoloma*, *Pholiota*, *Psilocybe* and *Stropharia*.

**stropharioid** Resembling a species of *Stropharia*, i.e. having a membranous ring on the stem, a convex cap, and purplish brown spores.

**substrate** Straw, sawdust, compost, soil, or any fibrous material on which mushrooms grow.

## t

**terrestrial** Growing on the ground.

**tertiary mycelium** Mycelium arising from secondary mycelium that is involved in mushroom fruitbody formation.

**tetrapolar** Having or located at four poles, as with the four spored basidia in most mushrooms.

**thermogenesis** The process of heat generation by microorganisms.

**thermophile** An organism thriving in 75-140°F. temperature zone.

**trama** The fleshy part of the cap between the cap cuticle and the fertile spore bearing layers of the mushroom gill.

**translucent** Transmitting light diffusely, semitransparent.

## u

**umbilicate** Depressed in the center region of the mushroom cap.

**umbo** A knob-like protrusion on the top center of the mushroom cap.

**umbonate** Having an umbo.

**uncinate** A type of gill attachment.

**undulating** Wavy.

**universal veil** An outer layer of tissue enveloping the cap and stem of some mushrooms, best seen in the youngest stages of fruitbody development.

## v

**variety** A sub-species epithet used to describe a consistently appearing variation of a particular mushroom species.

**vector** The pathway by which a disease is spread; the “vehicle” for distributing a pathogen.

**veil** A tissue covering mushrooms as they develop.

**vesicle** A small bulb-like swelling (sometimes bladder-like).

**viscid** Slimy or slippery when moist, sticky to the touch when partially dry. A characteristic of the mushroom cap or stem.

## z

**zonate** Having a band-like region darker in color or different in form than the surrounding tissue.